

APPENDIX E

Interconnect Service Package Diagrams

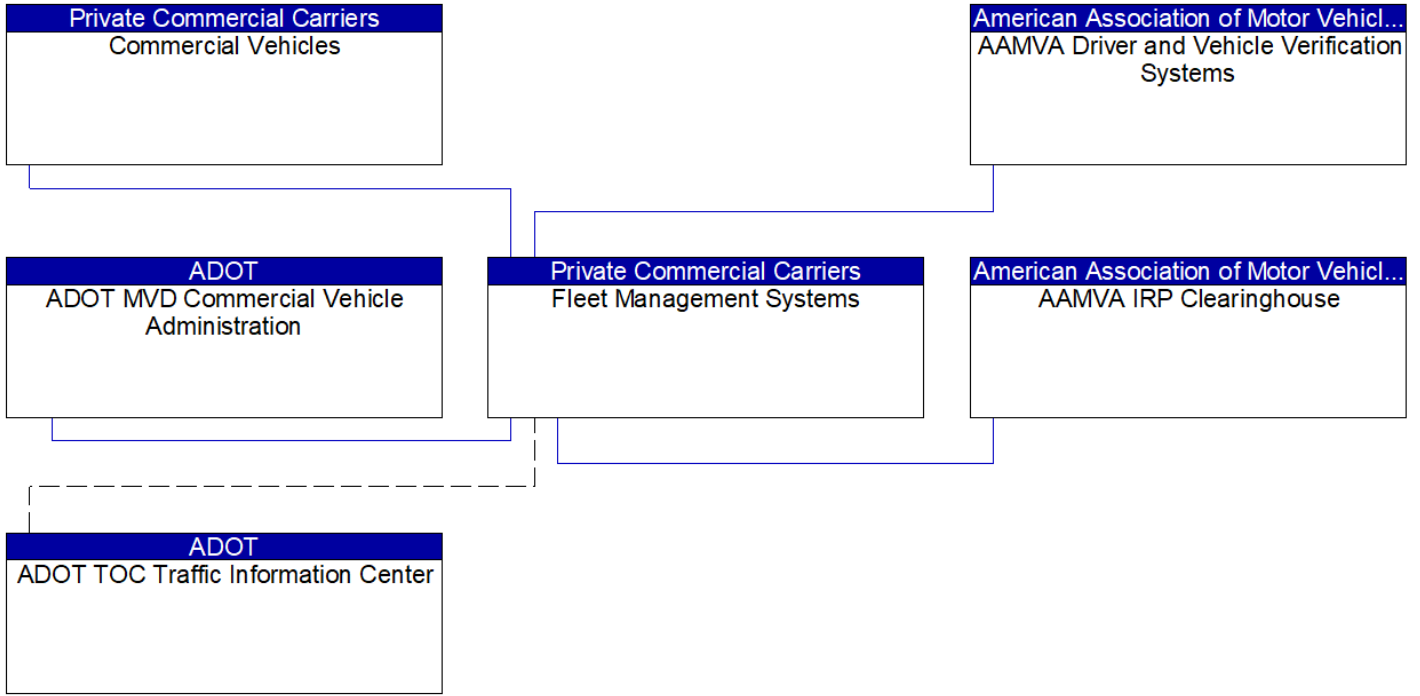

— Existing
 - - - Planned

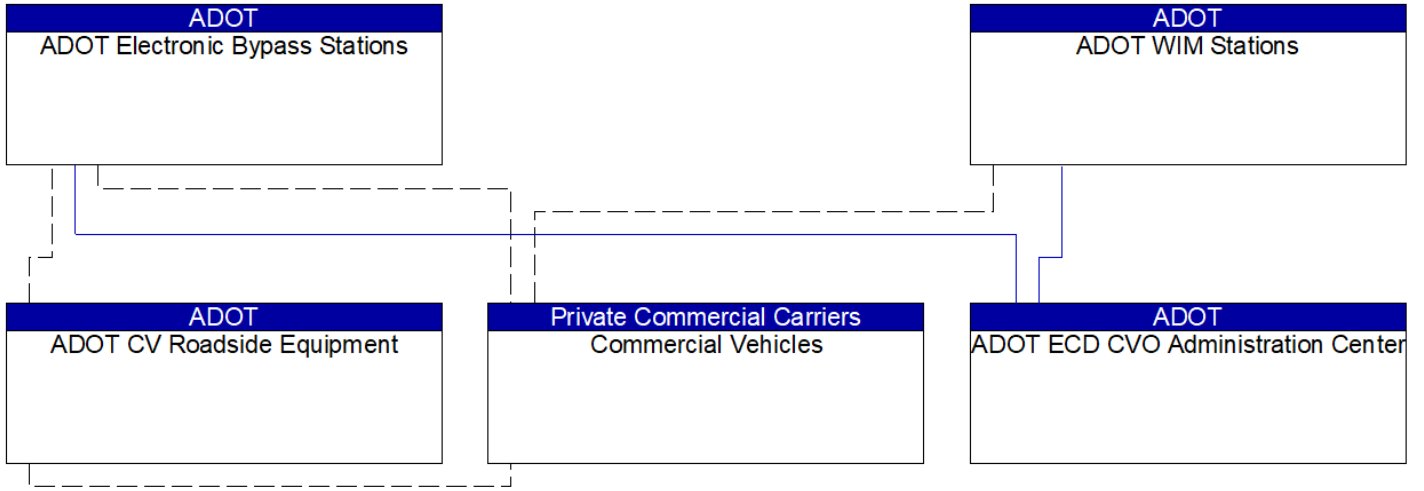

———— Existing
- - - - - Planned

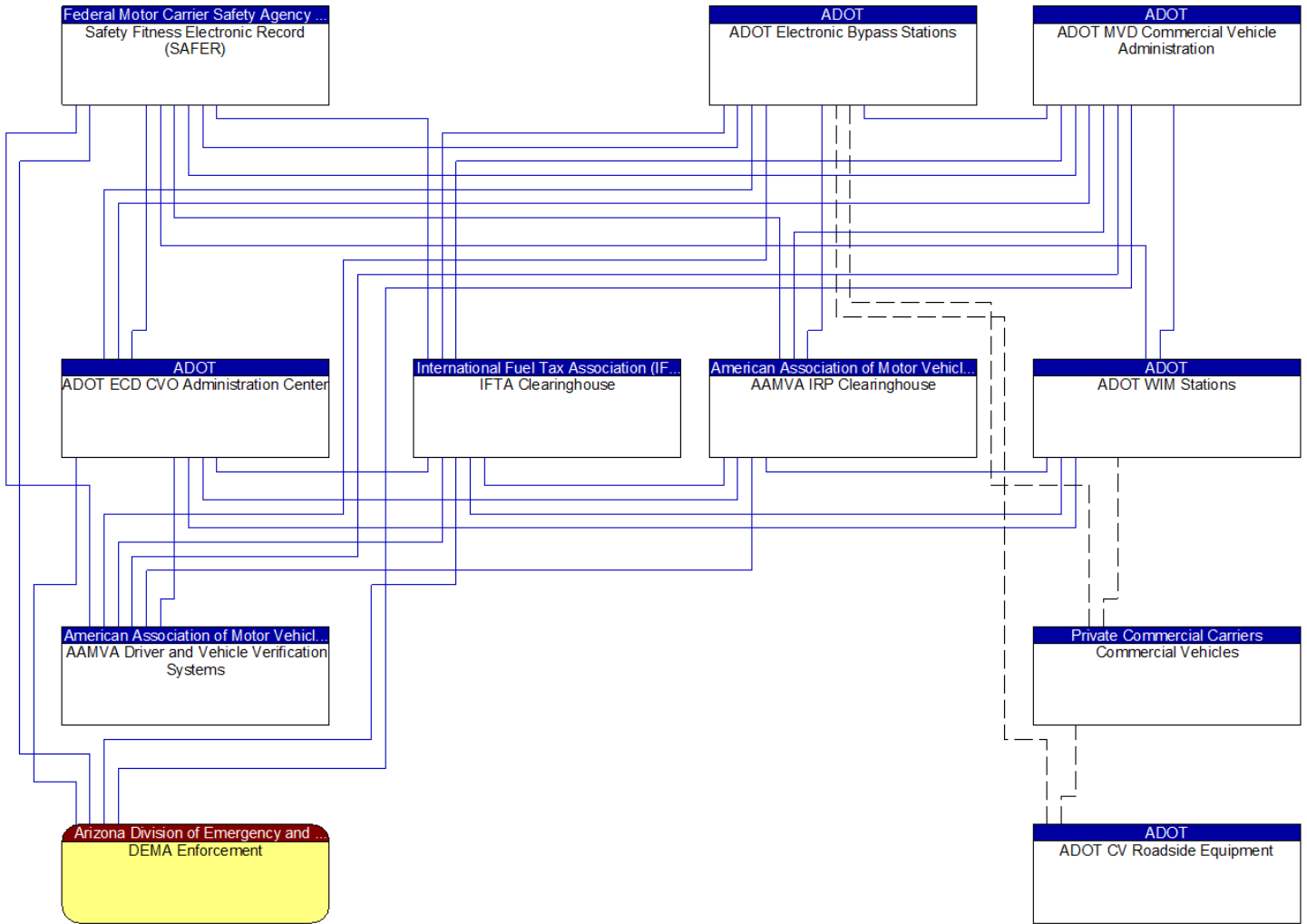

— Existing
- - - Planned

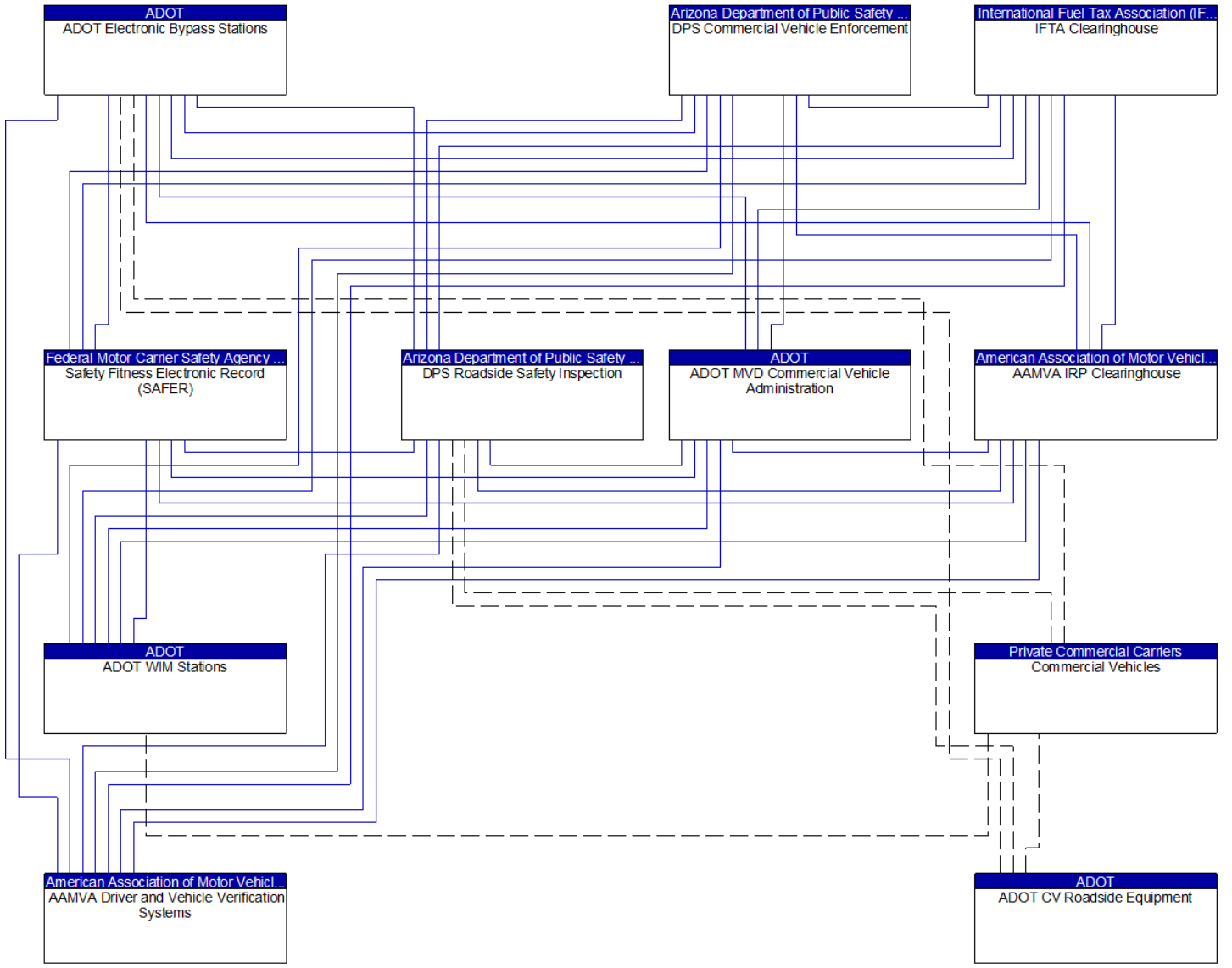

— Existing
 - - - Planned

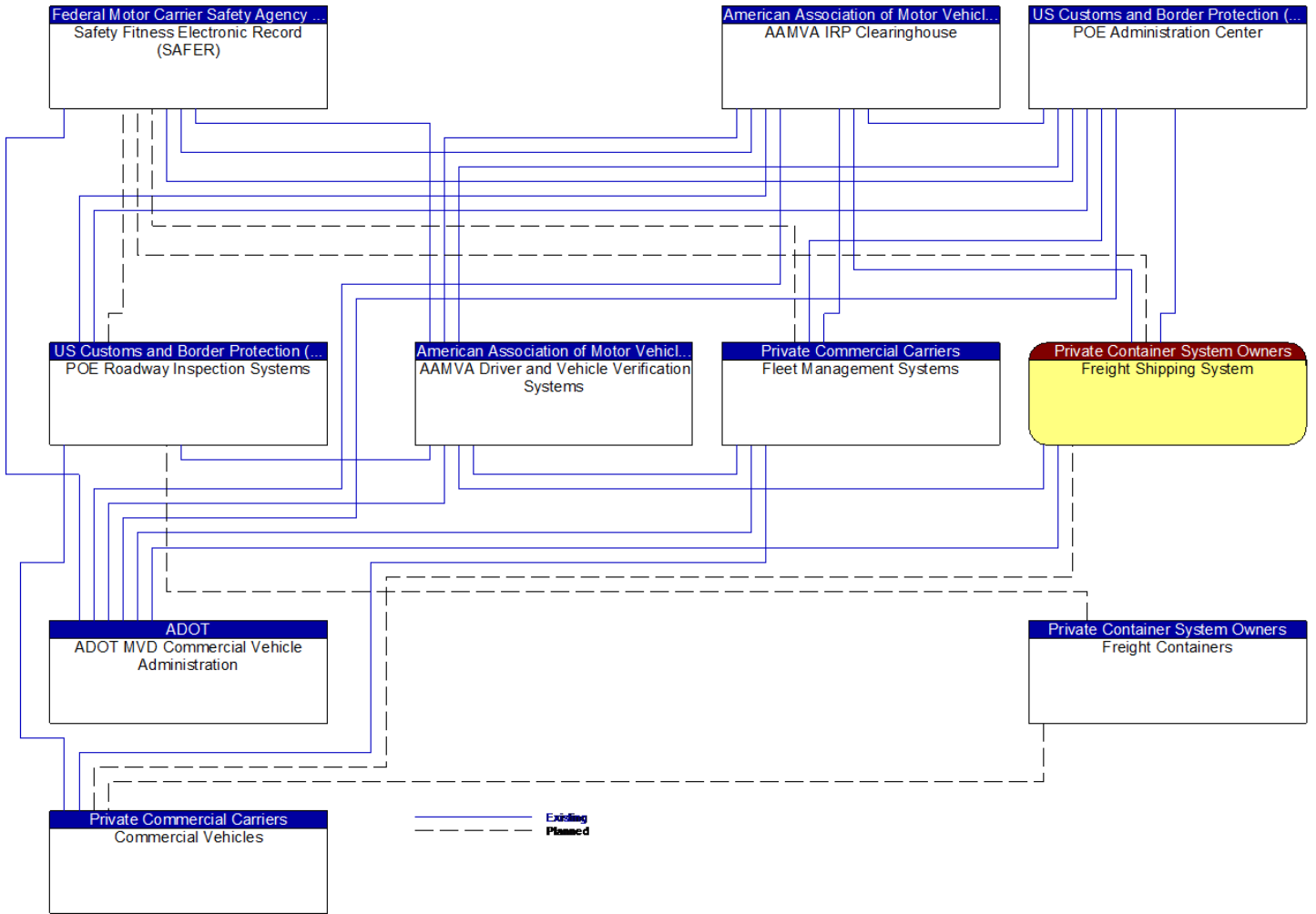

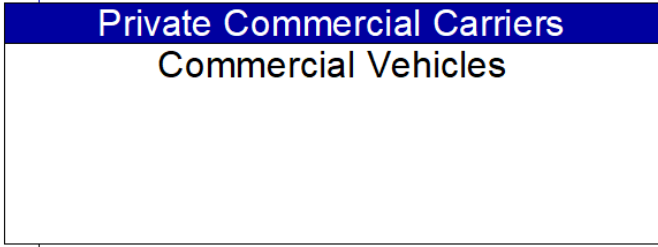
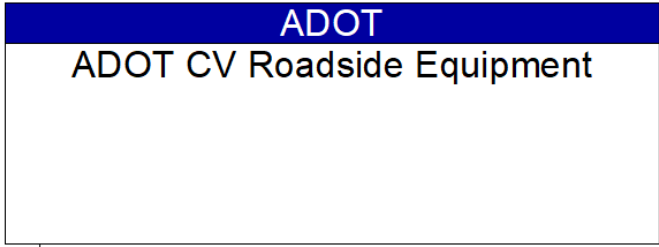
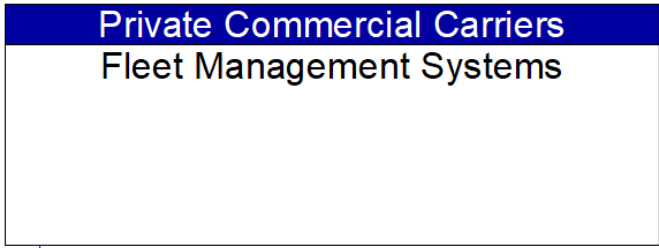

———— Existing
----- Planned

Arizona Department of Public Safety ...
DPS Commercial Vehicle Enforcement

Federal Motor Carrier Safety Agency ...
Safety Fitness Electronic Record
(SAFER)

ADOT
ADOT MVD Commercial Vehicle
Administration

Arizona Department of Public Safety ...
DPS Roadside Safety Inspection

Private Commercial Carriers
Commercial Vehicles

Private Commercial Carriers
Driver Identification Card

Existing
Planned

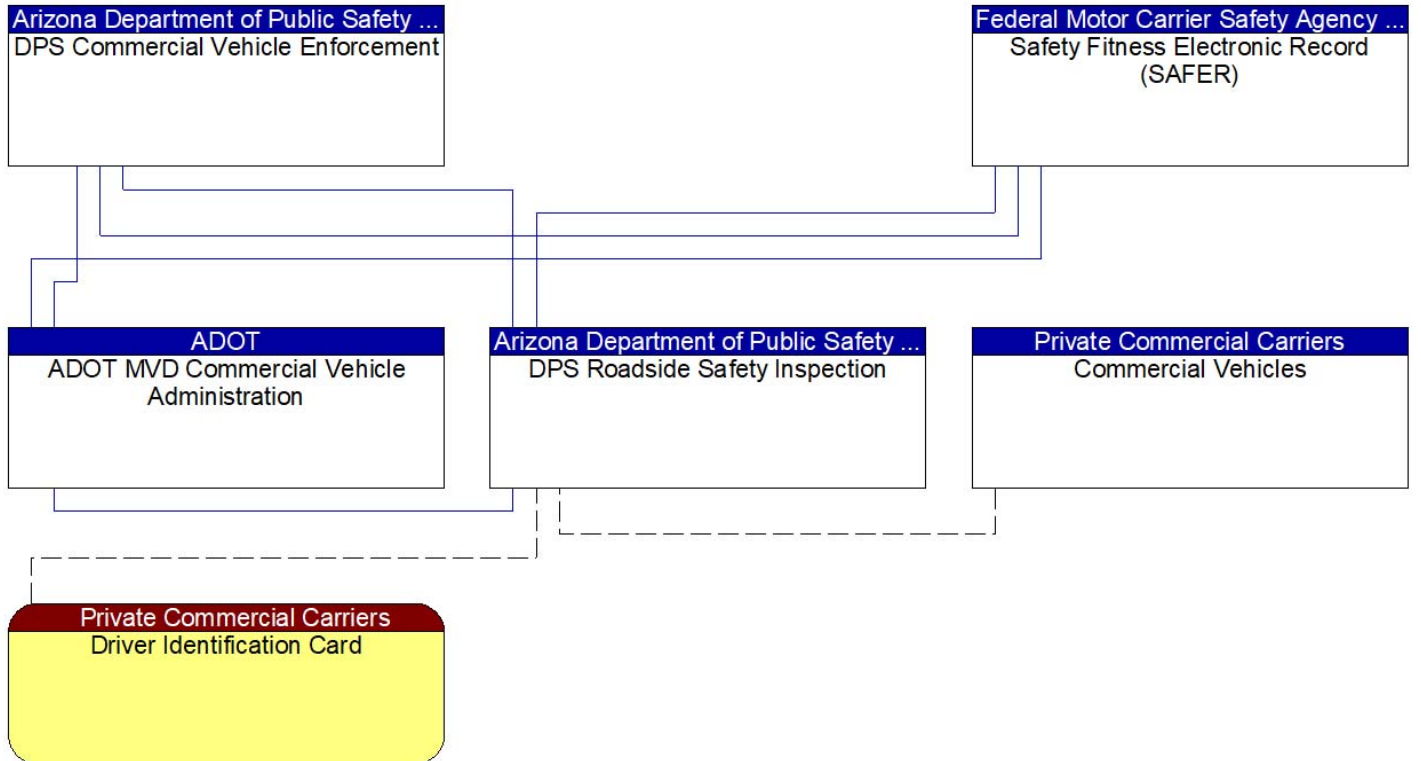

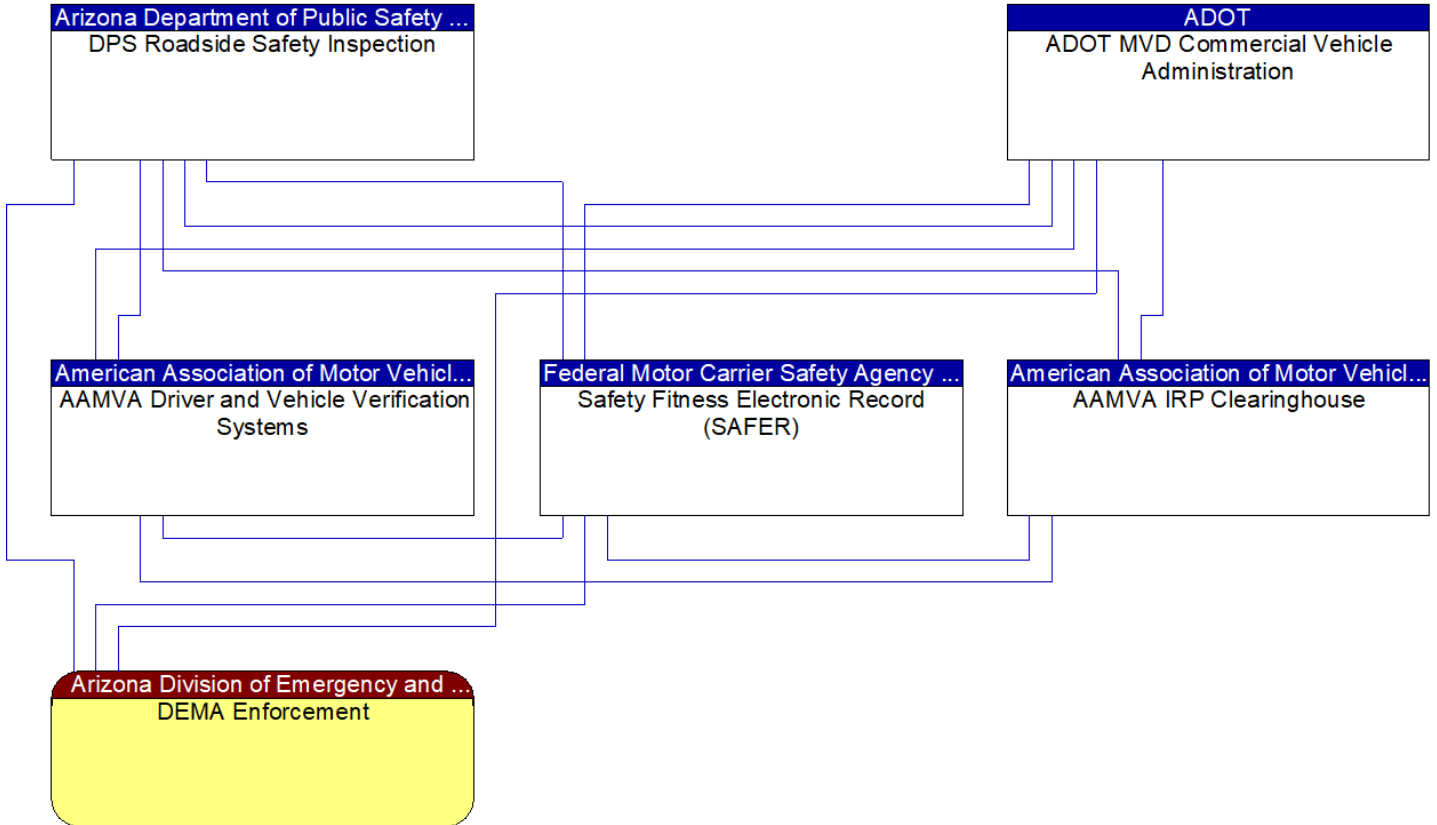

Existing

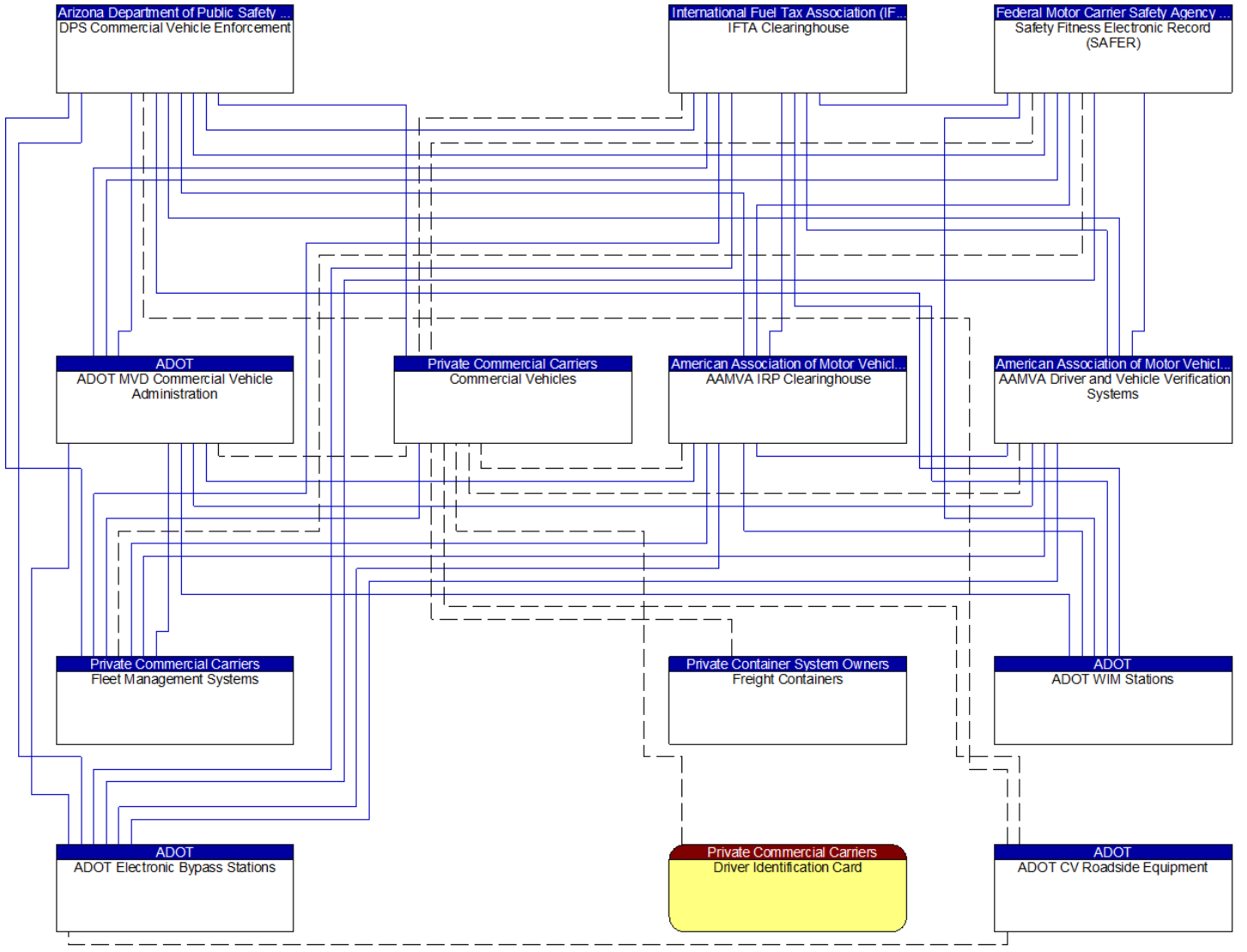

— Existing
 - - - Planned

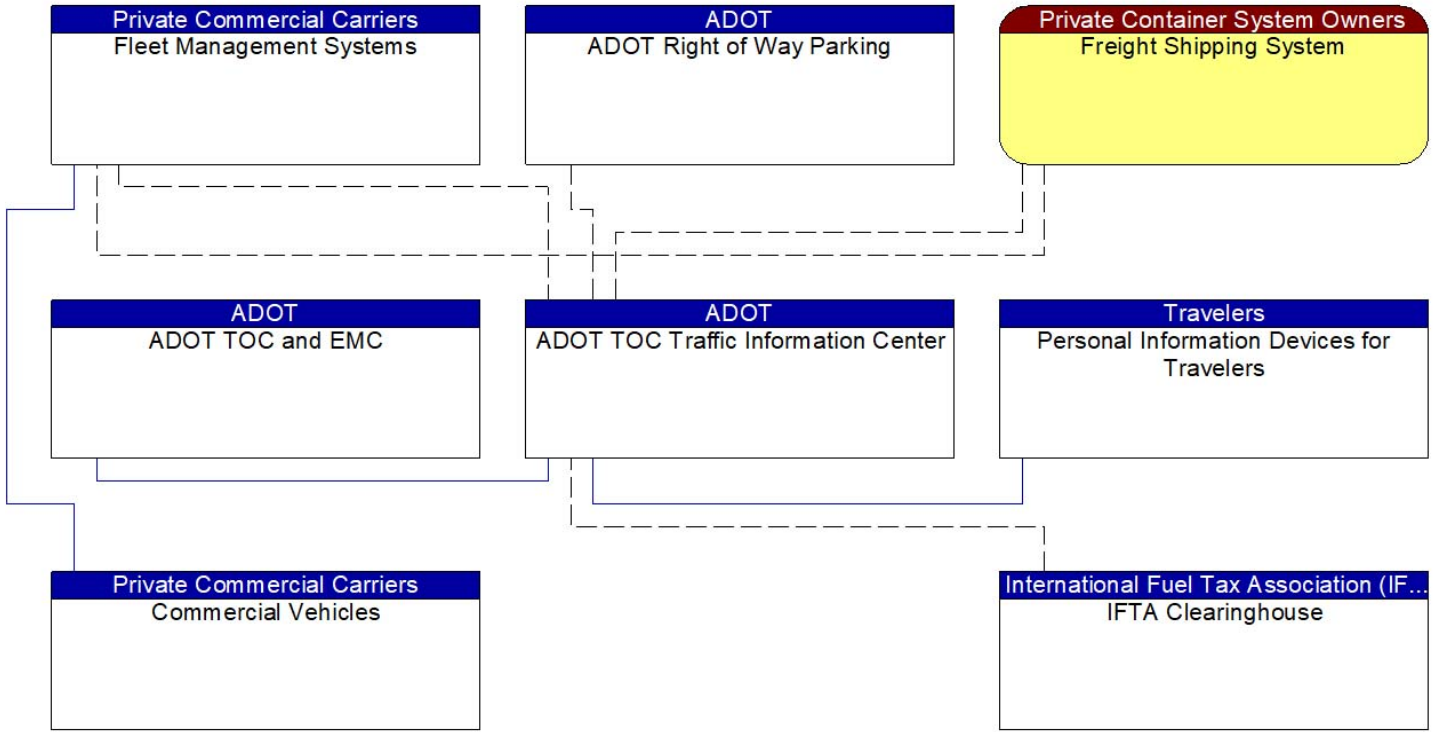

————— Existing
 - - - - - Planned

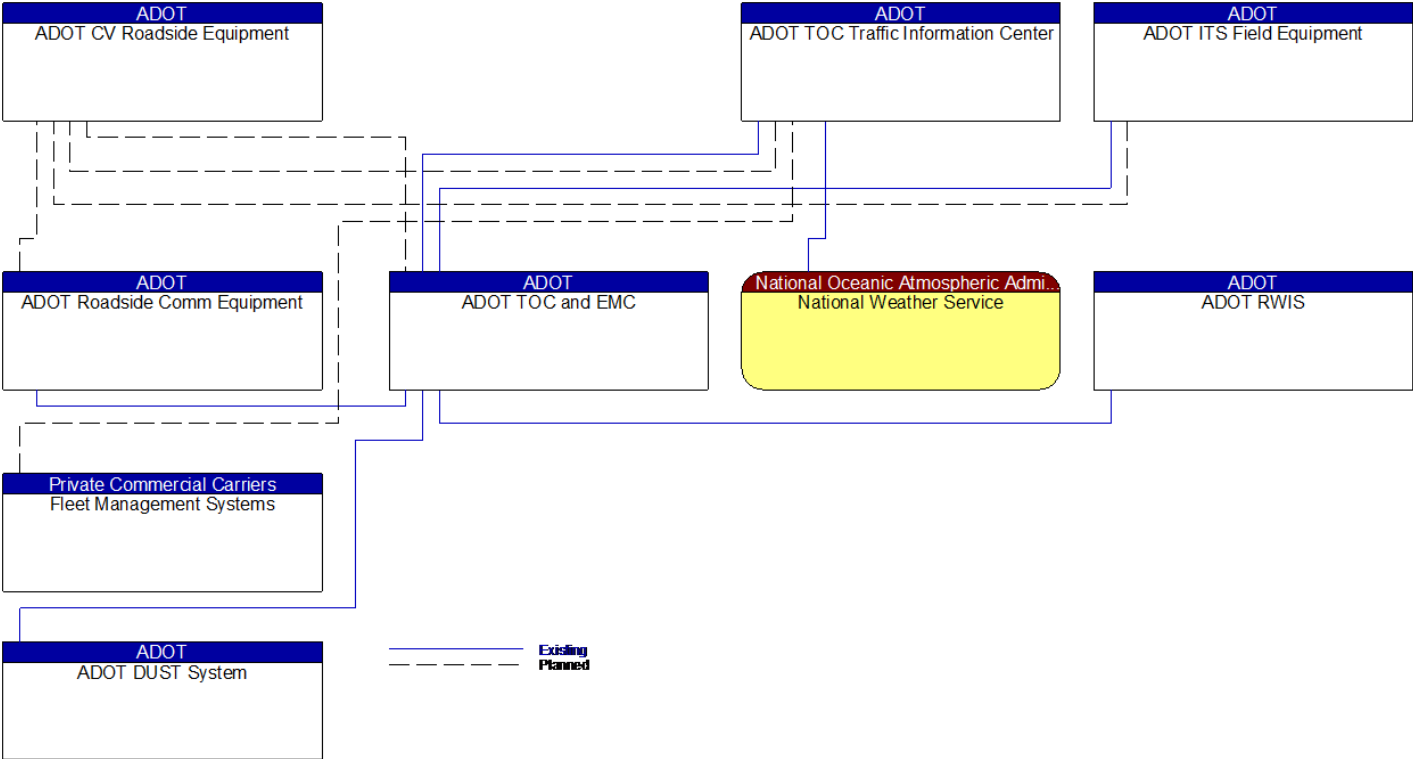

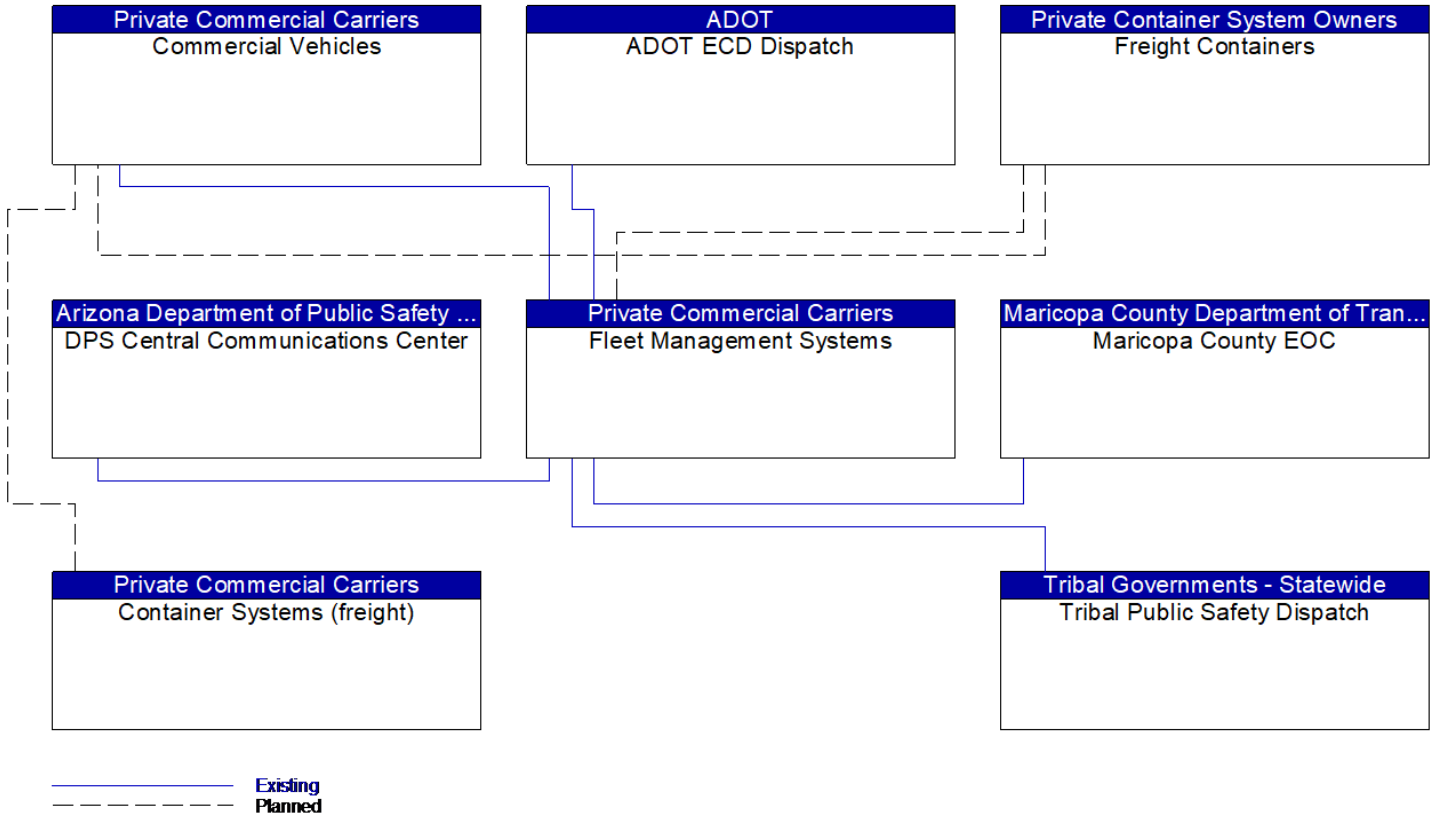

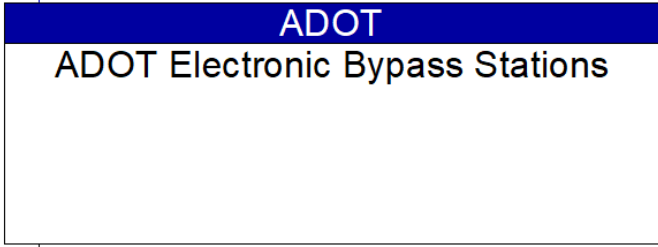
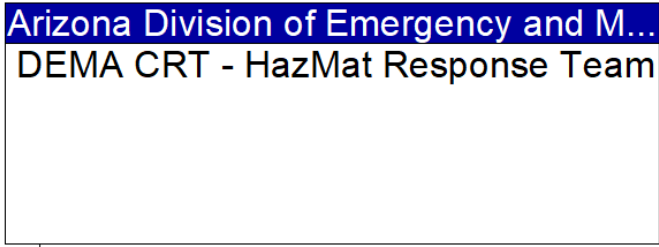
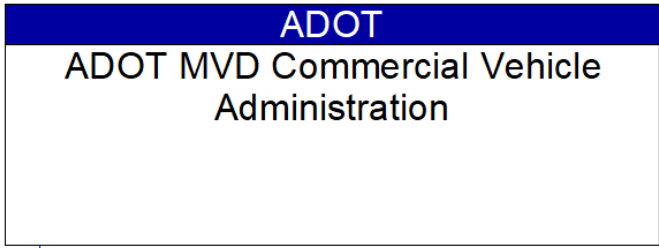

———— Existing
----- Planned

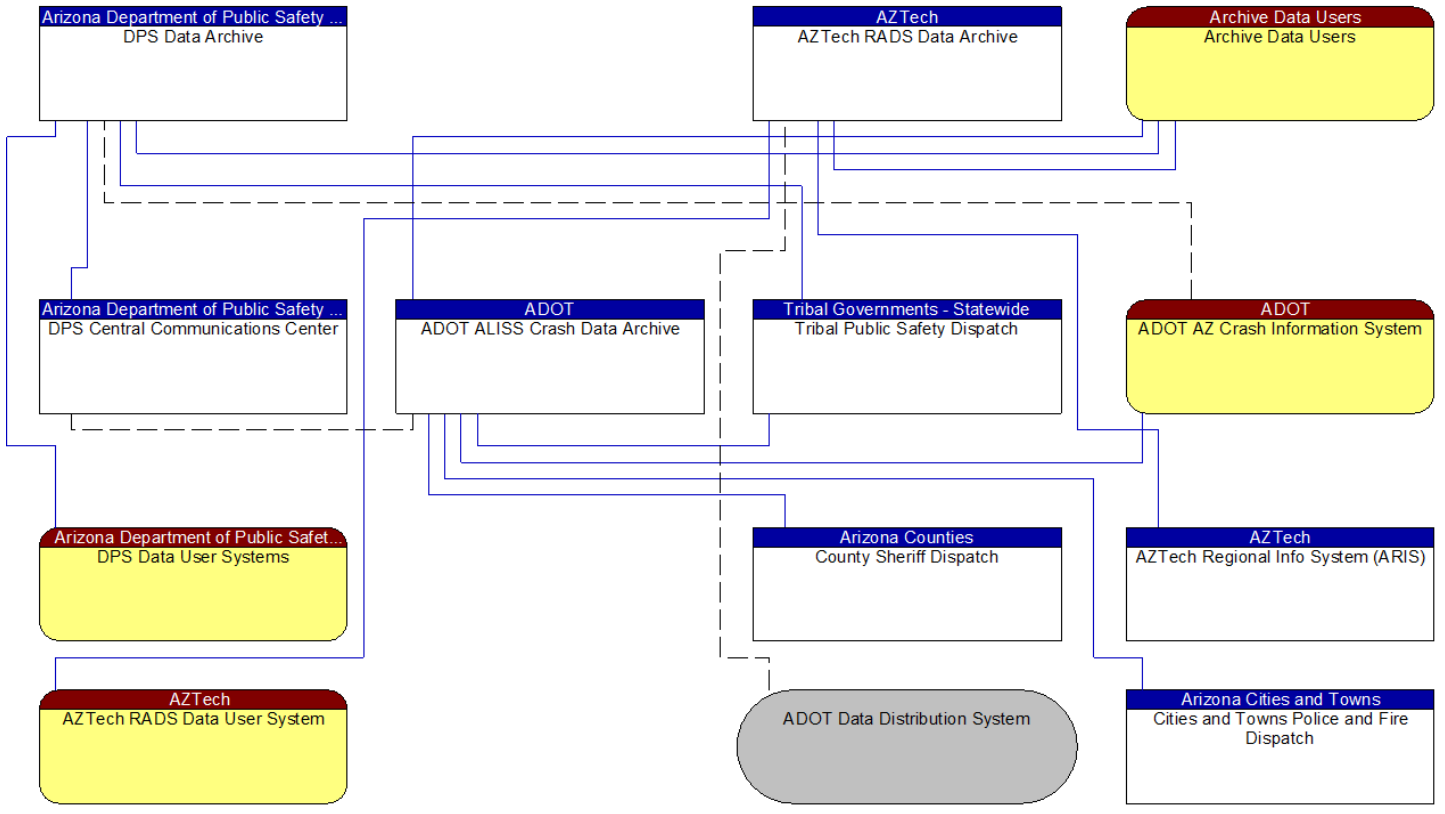

— Existing
 - - - Planned

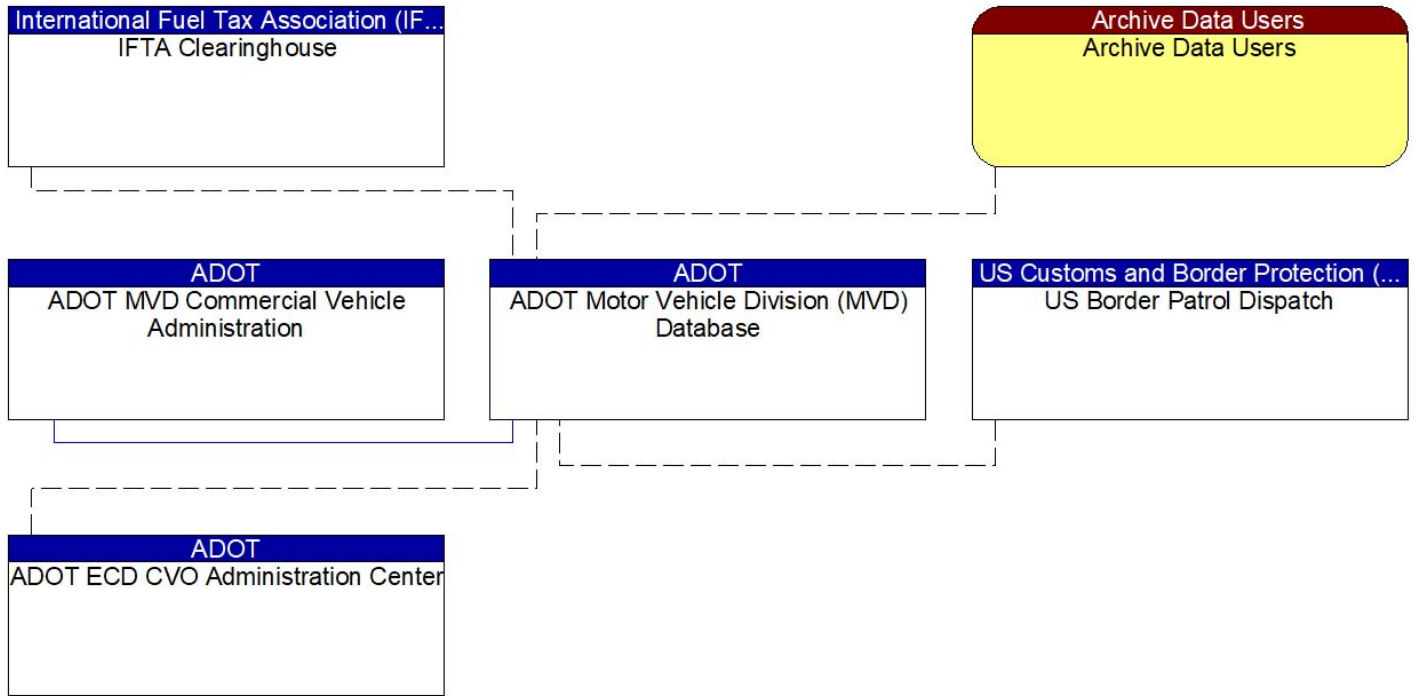

_____ Existing
 - - - - - Planned

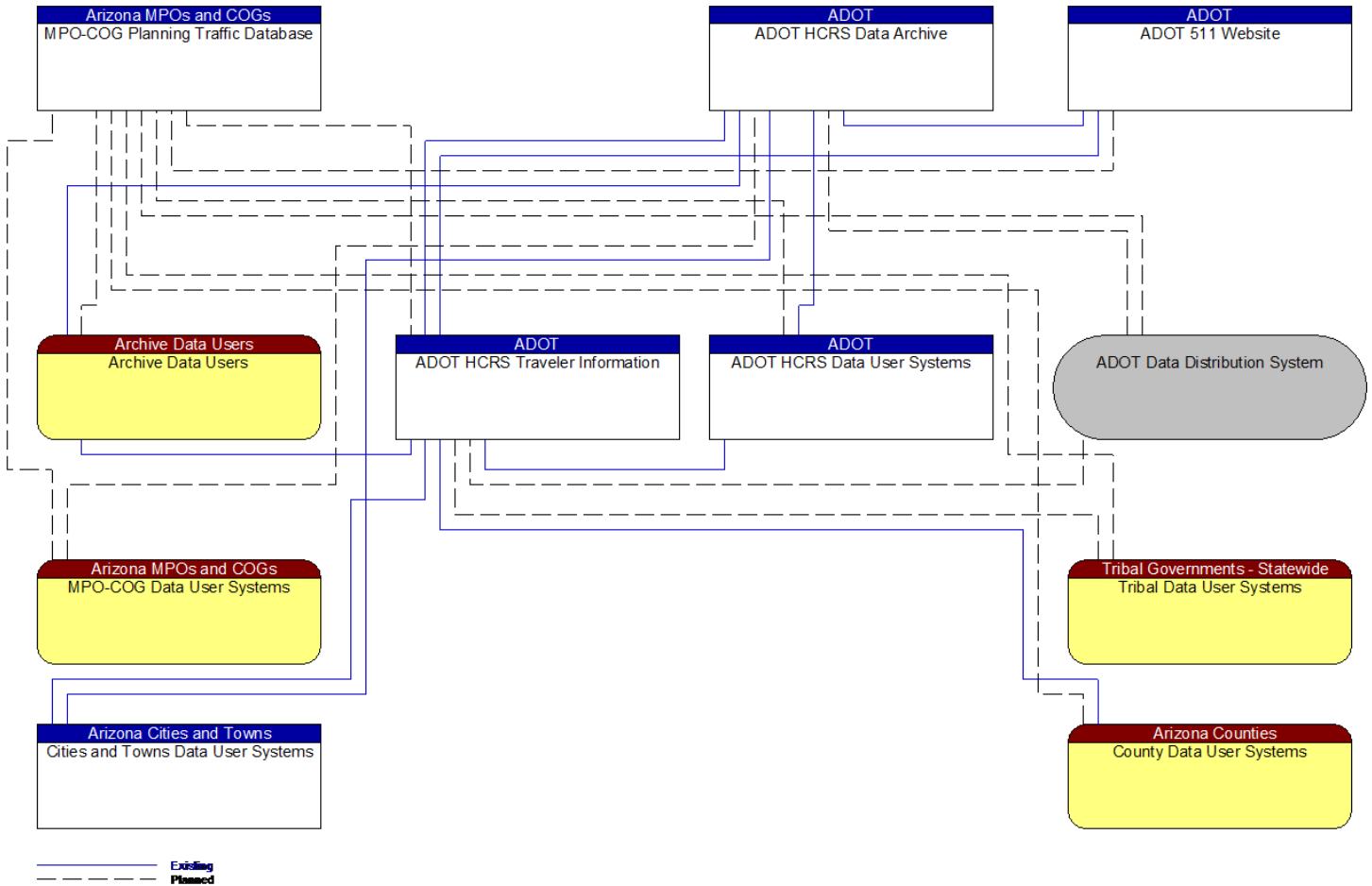

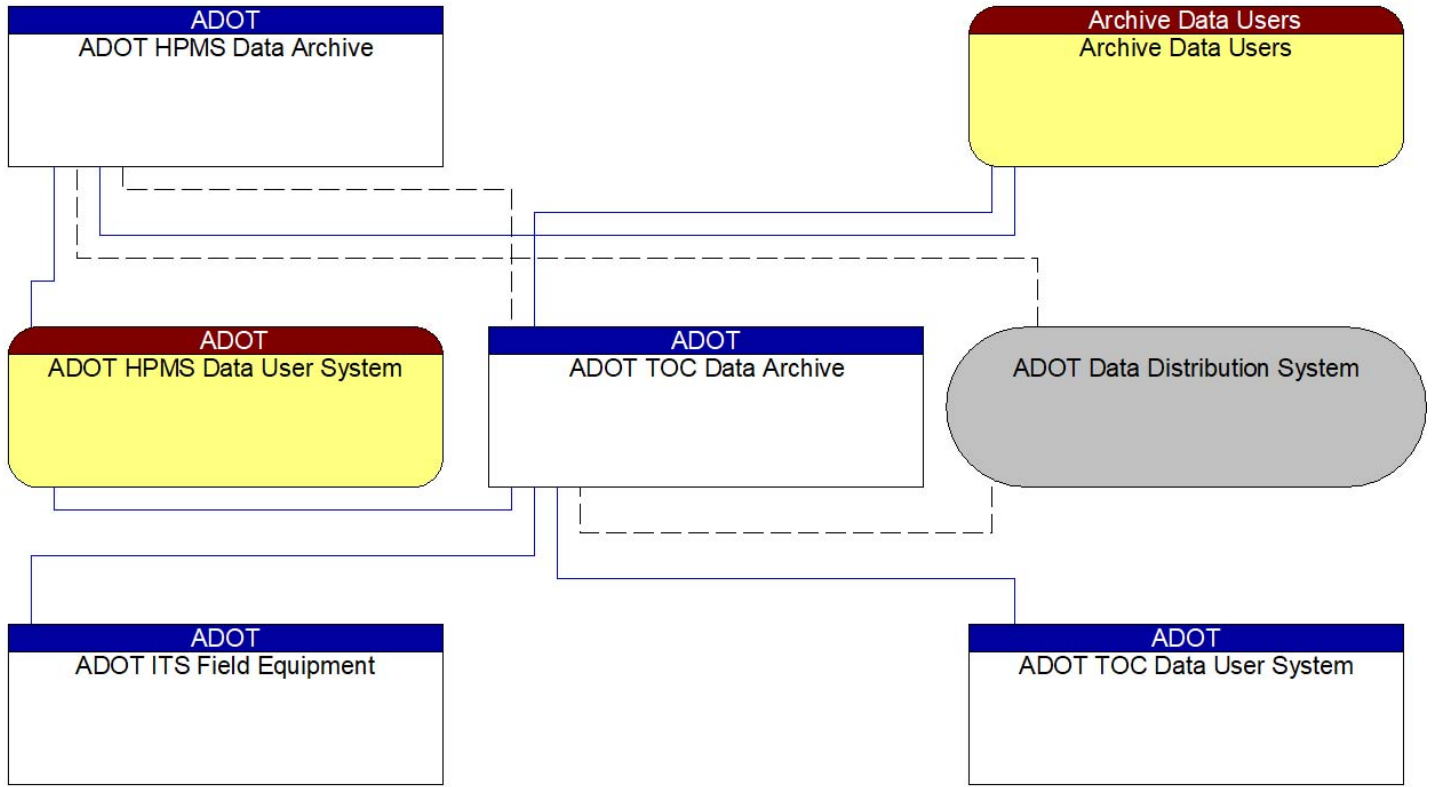

— Existing
 - - - Planned

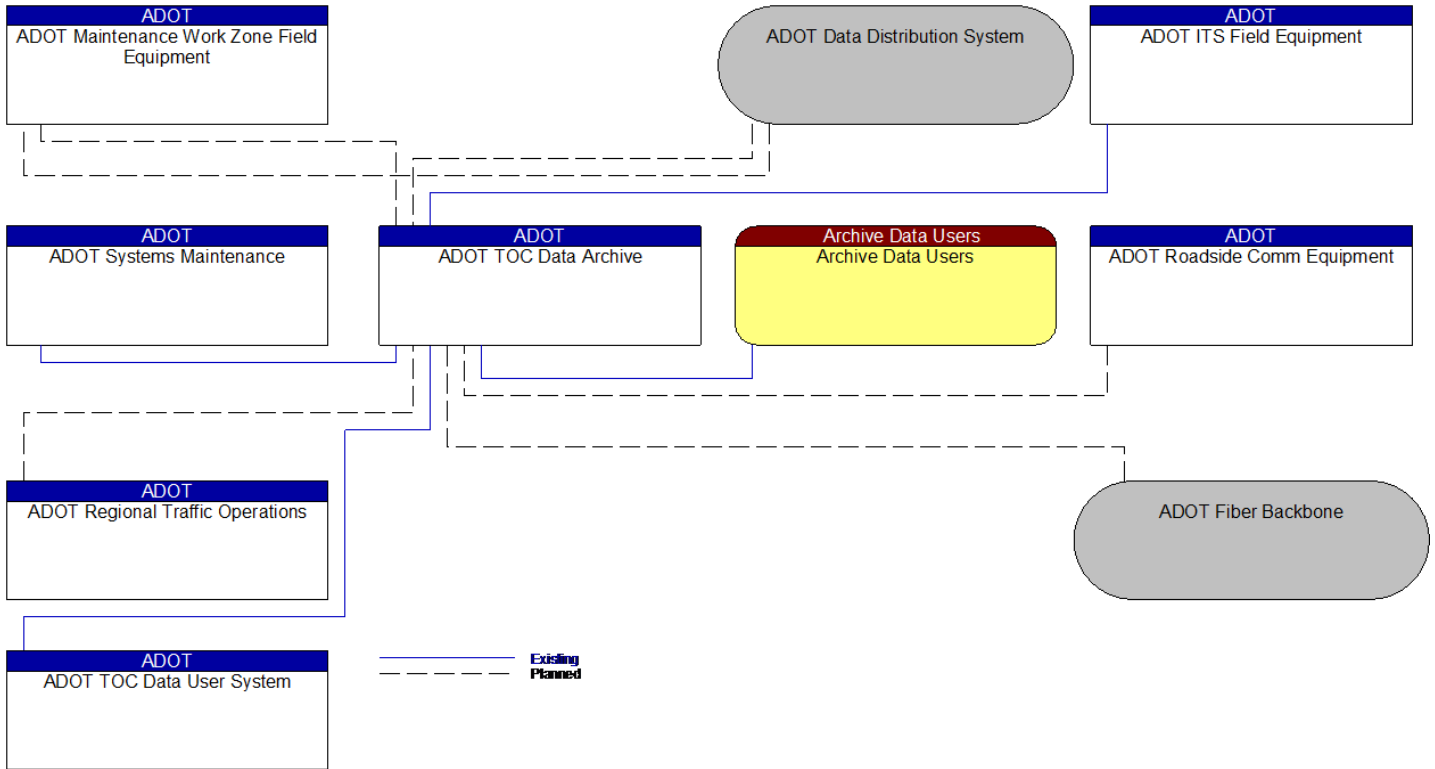

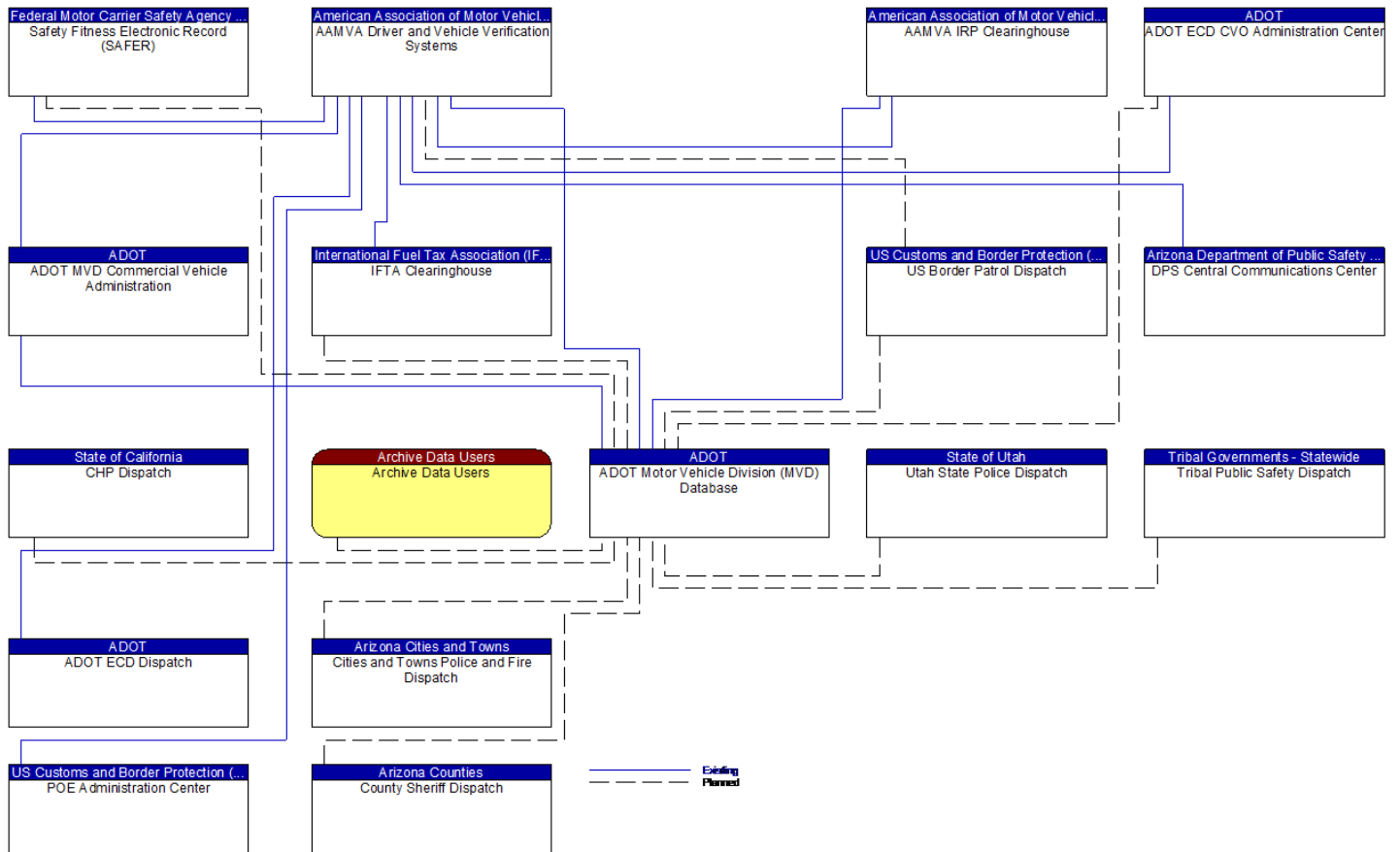

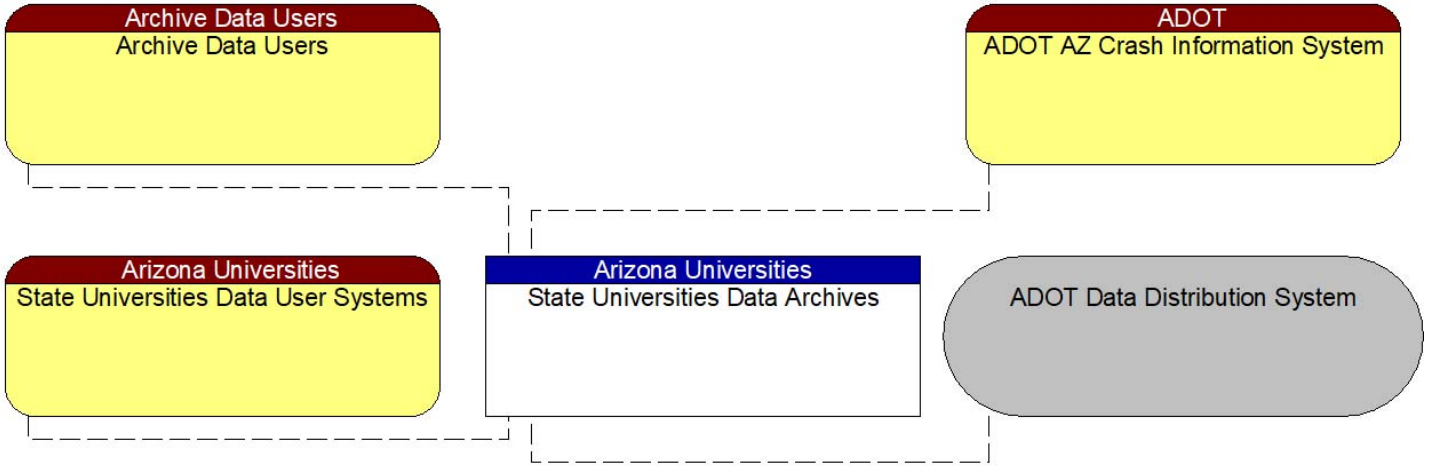

----- **Planned**

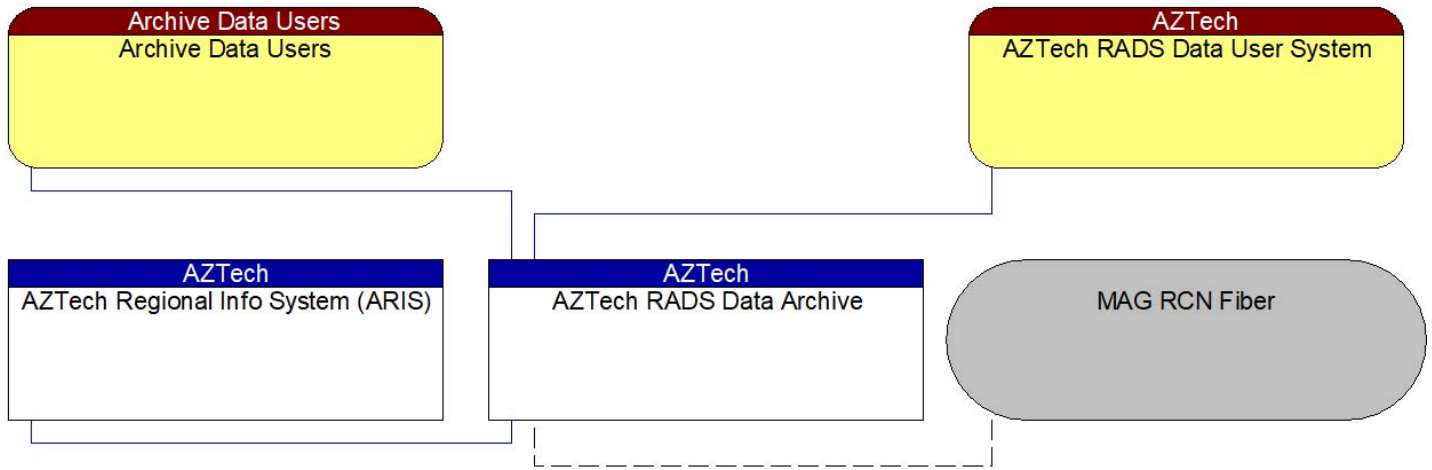

———— Existing
----- Planned

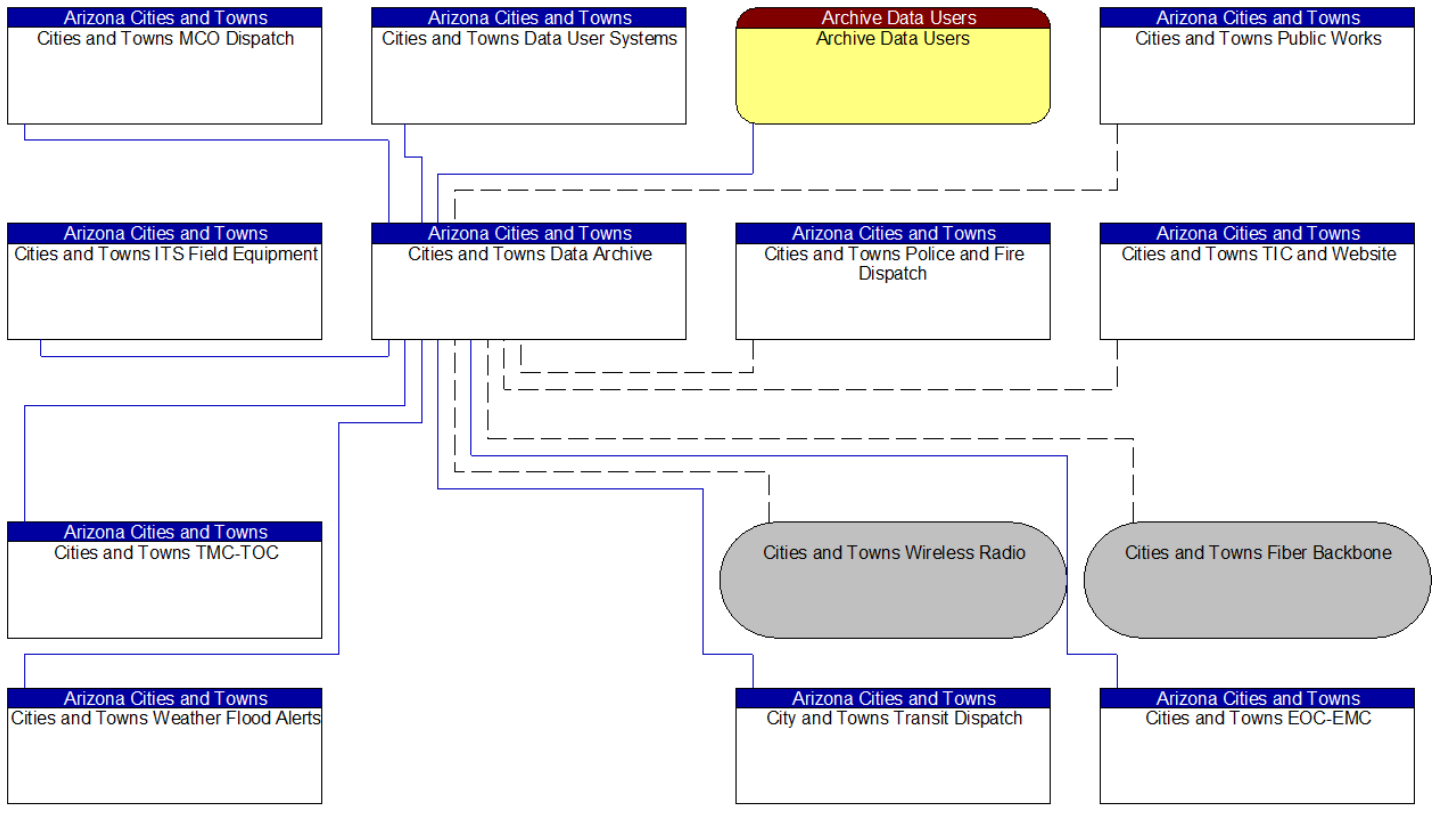

——— Existing
- - - - - Planned

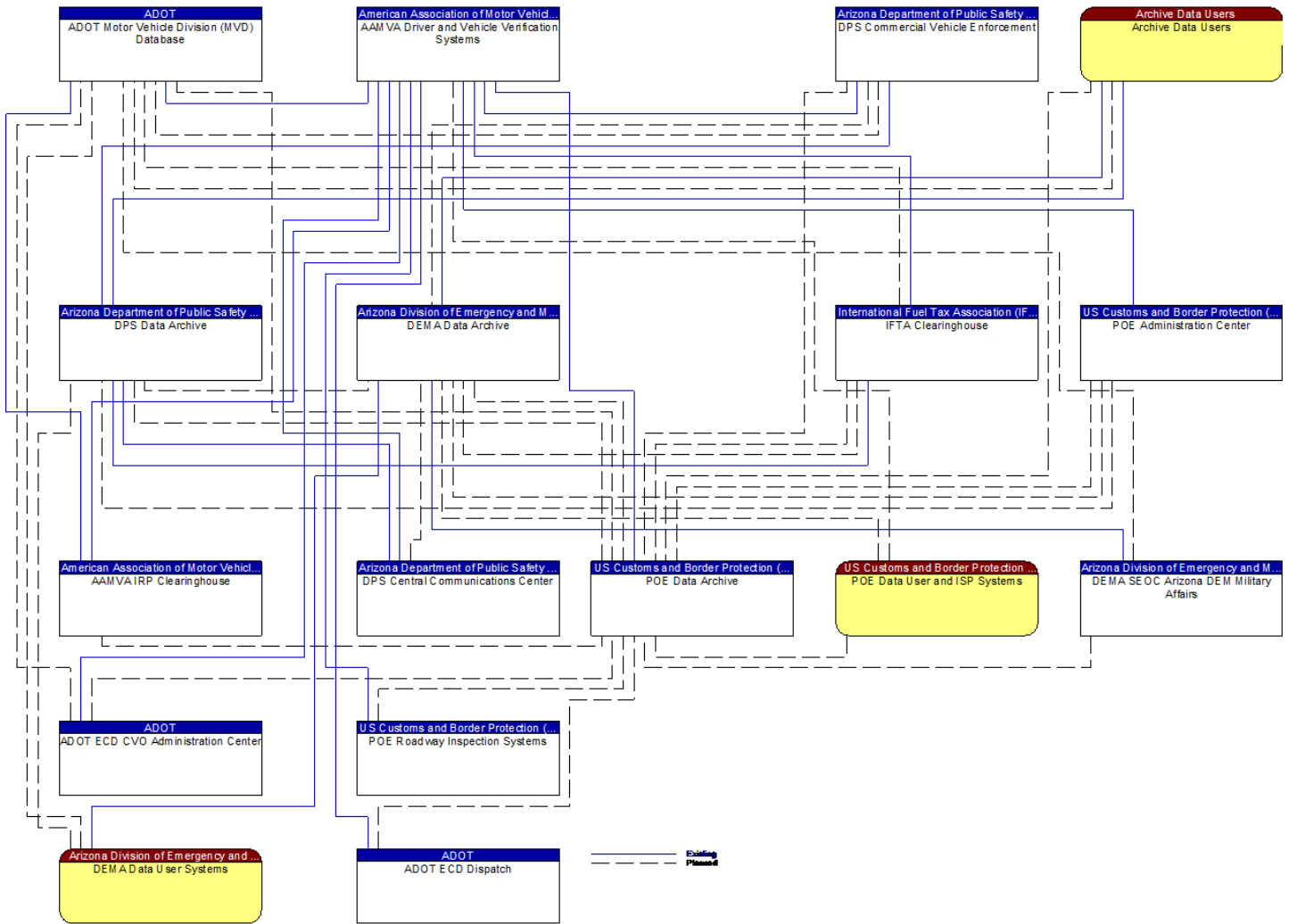

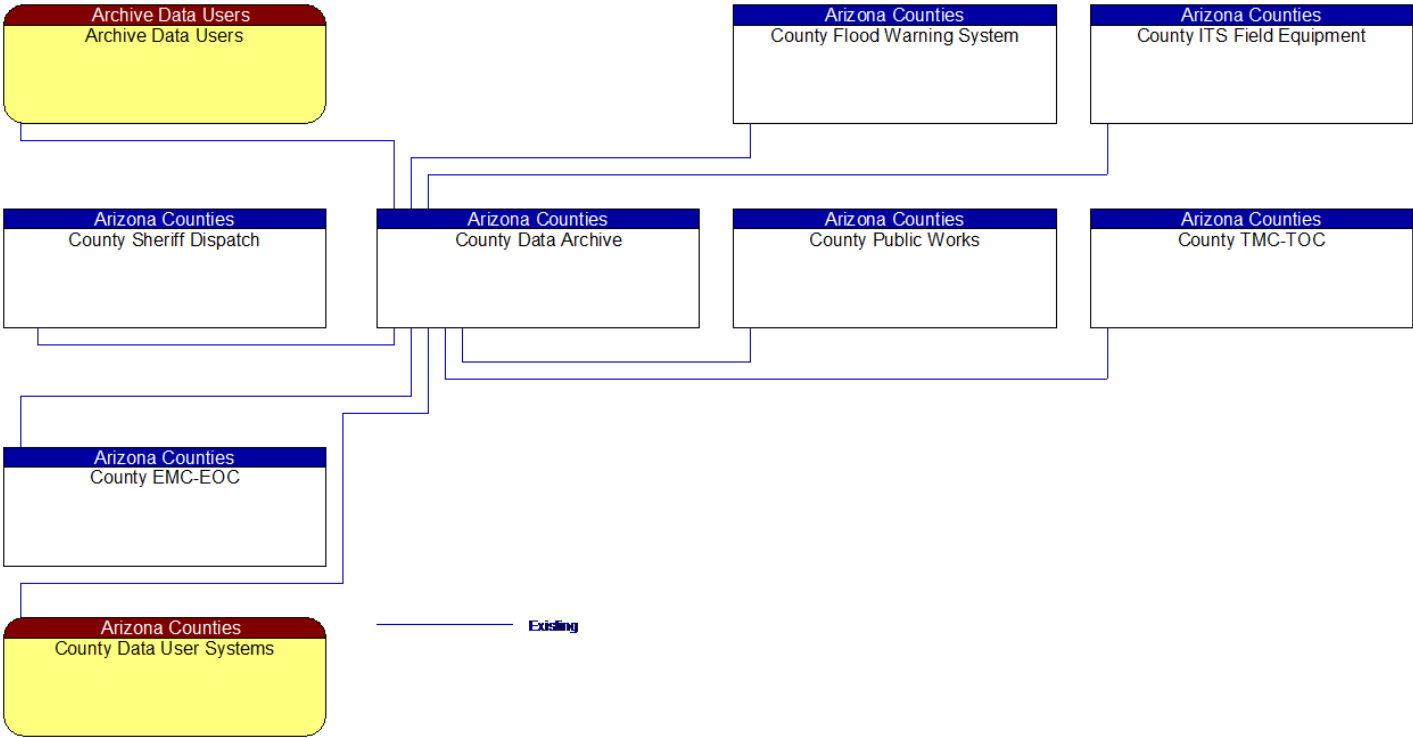

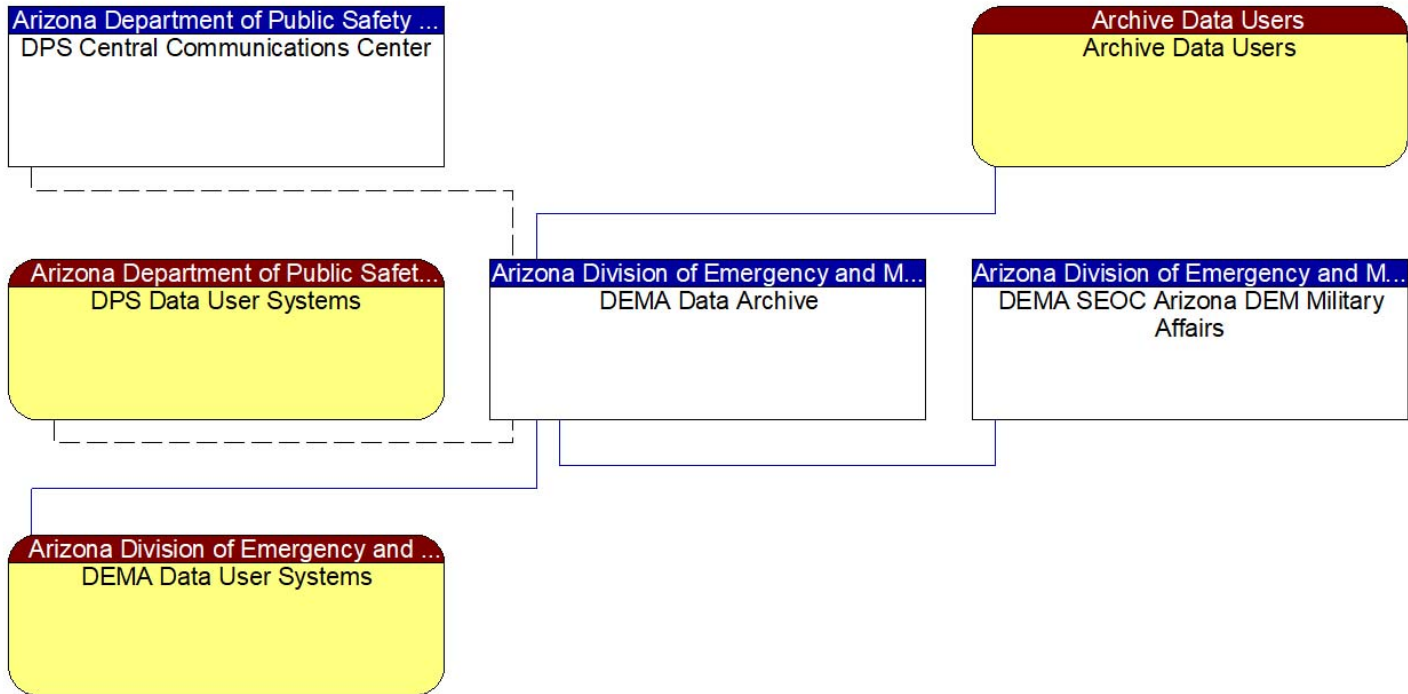

— Existing
 - - - Planned

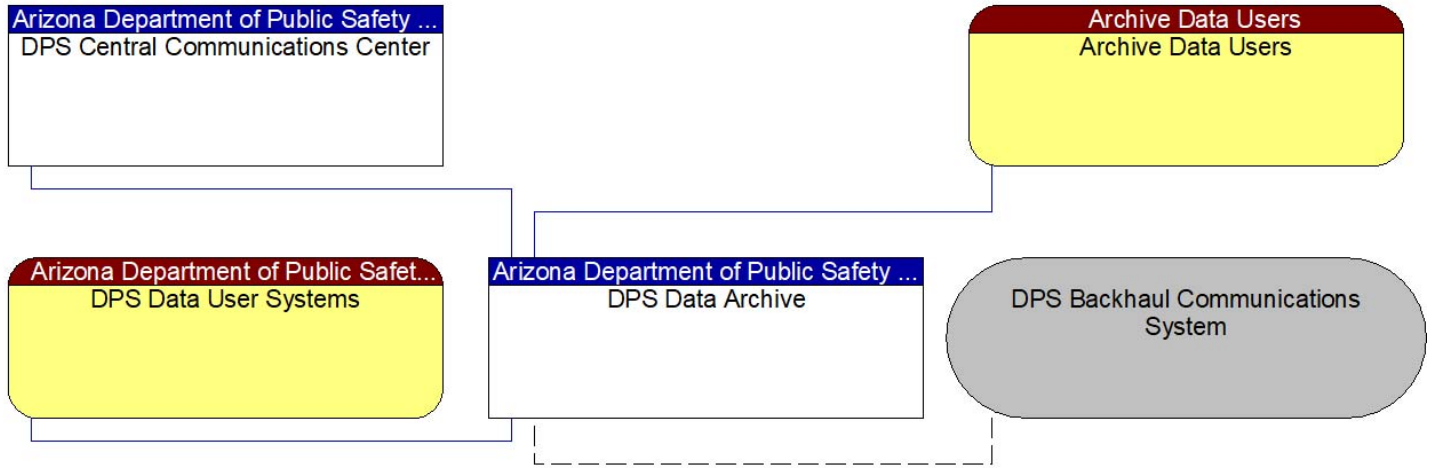

————— Existing
 - - - - - Planned

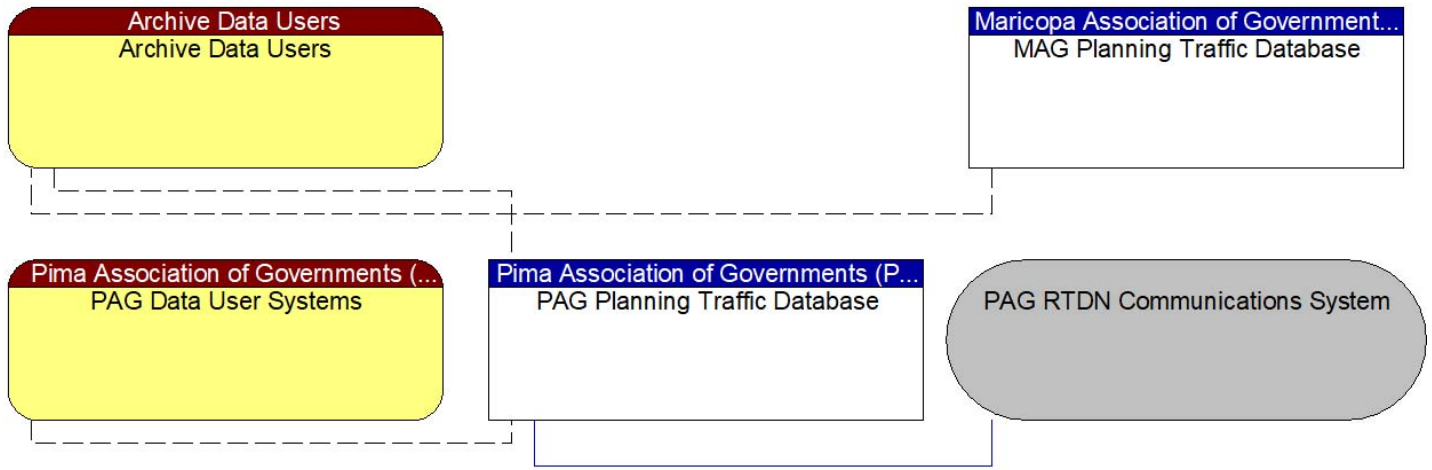

———— Existing
----- Planned

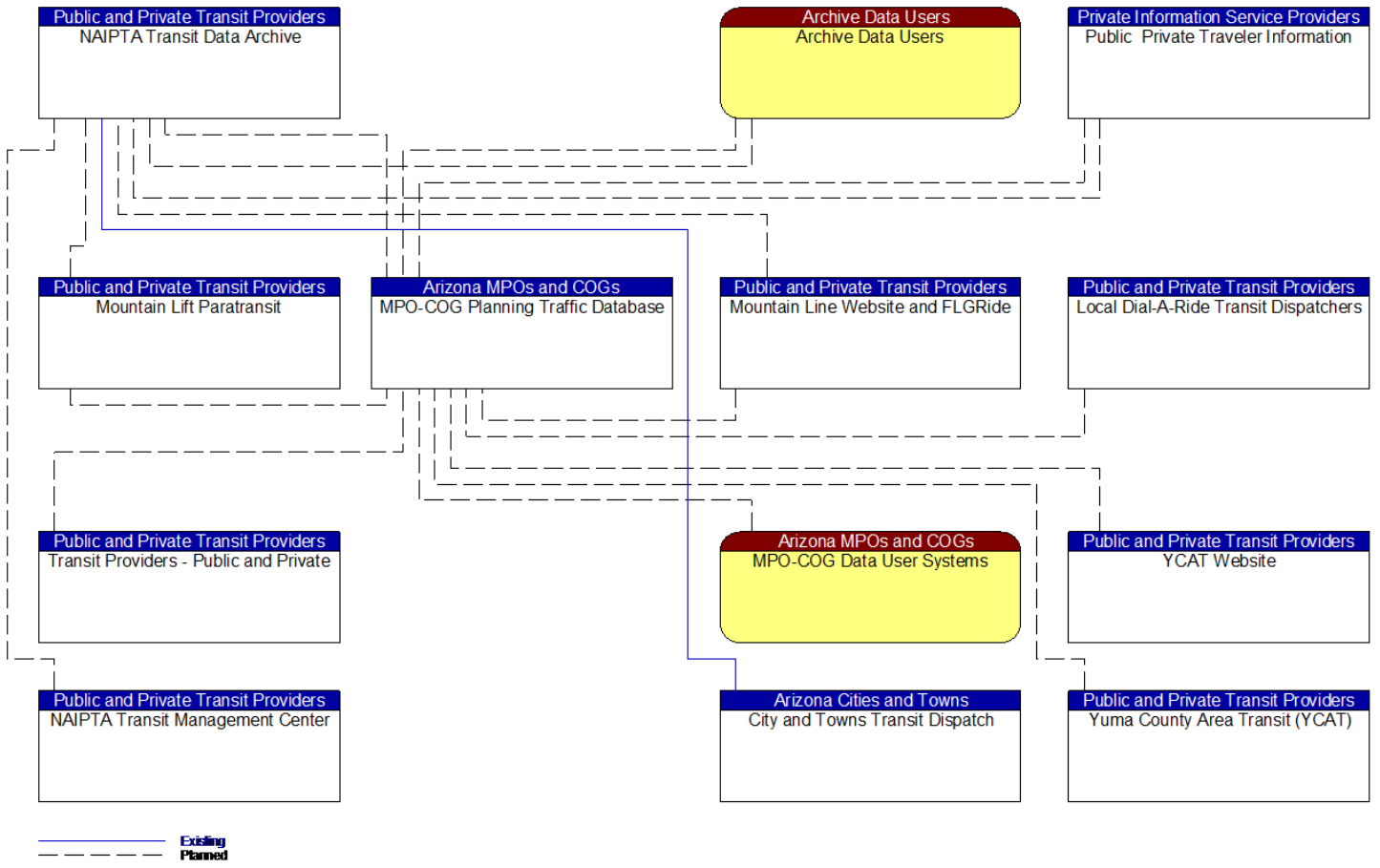

Public and Private Transit Providers
NAIPTA Transit Data Archive

Archive Data Users
Archive Data Users

Private Information Service Providers
Public Private Traveler Information

Public and Private Transit Providers
Mountain Lift Paratransit

Arizona MPOs and COGs
MPO-COG Planning Traffic Database

Public and Private Transit Providers
Mountain Line Website and FLGRide

Public and Private Transit Providers
Local Dial-A-Ride Transit Dispatchers

Public and Private Transit Providers
Transit Providers - Public and Private

Arizona MPOs and COGs
MPO-COG Data User Systems

Public and Private Transit Providers
YCAT Website

Public and Private Transit Providers
NAIPTA Transit Management Center

Arizona Cities and Towns
City and Towns Transit Dispatch

Public and Private Transit Providers
Yuma County Area Transit (YCAT)

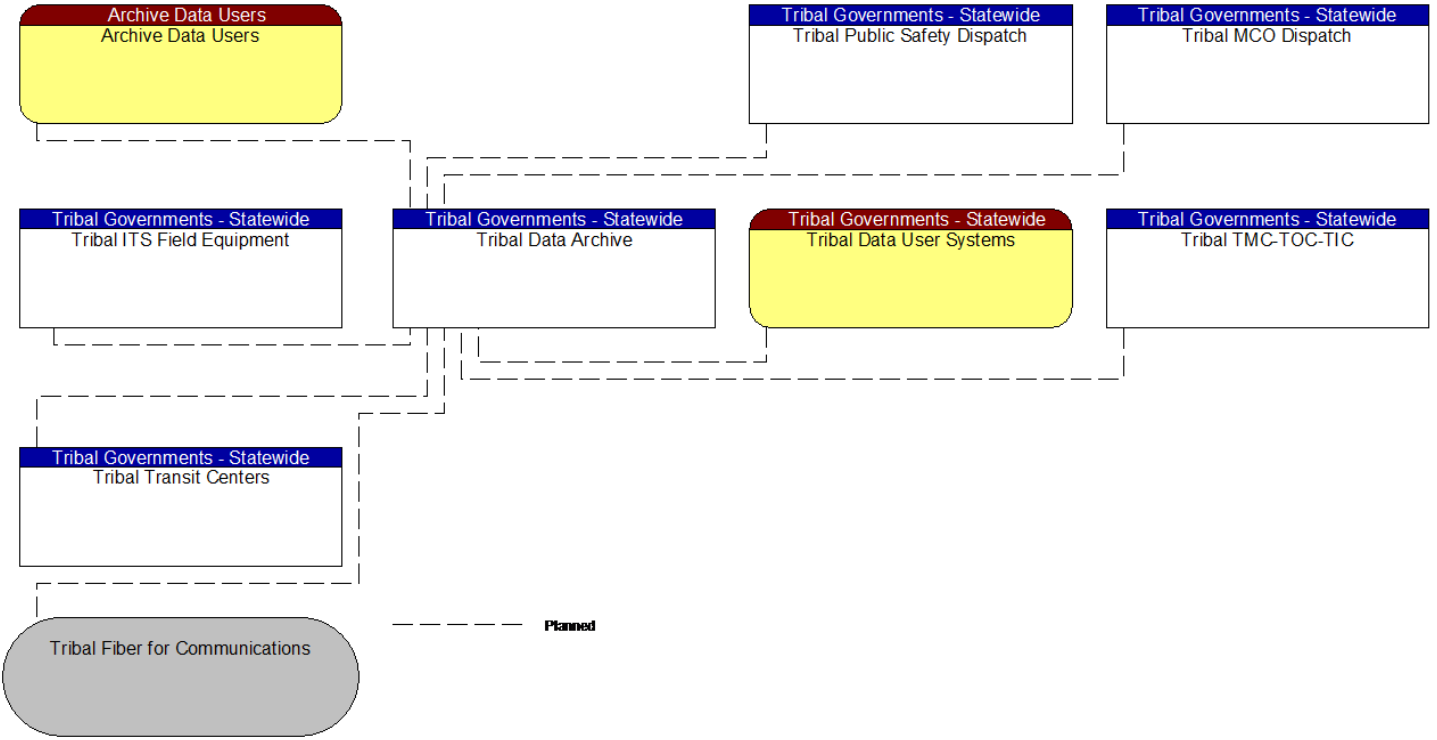

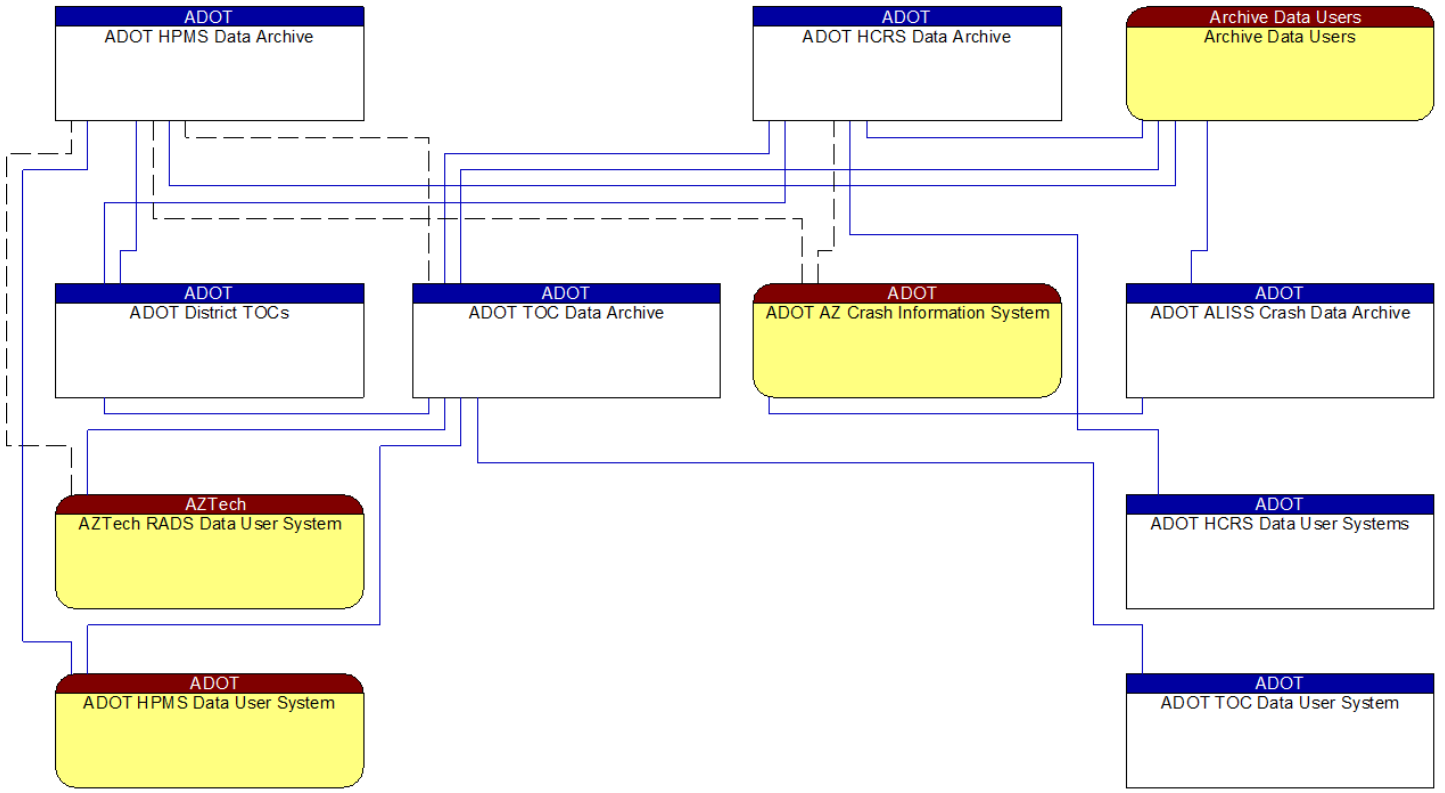

——— Existing
- - - - Planned

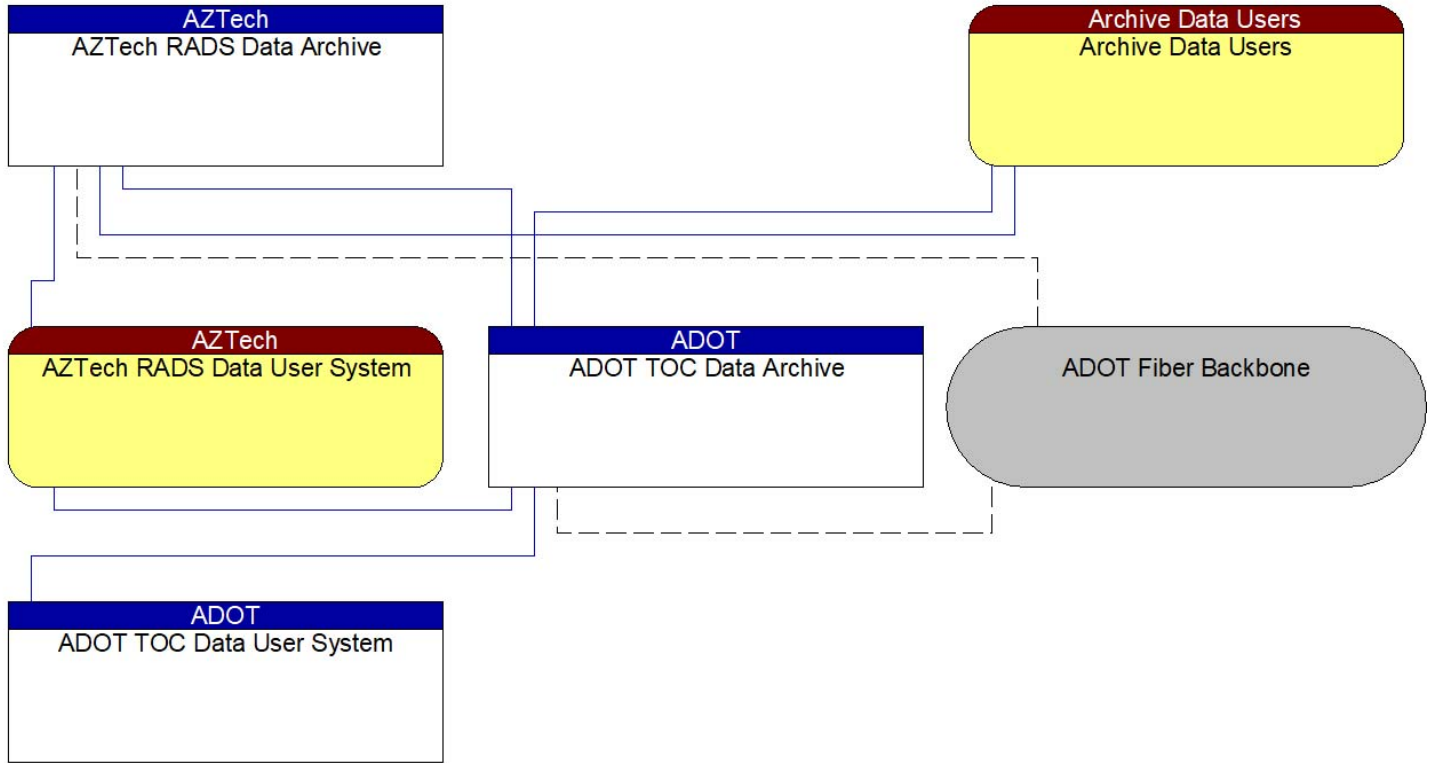

————— Existing
 - - - - - Planned

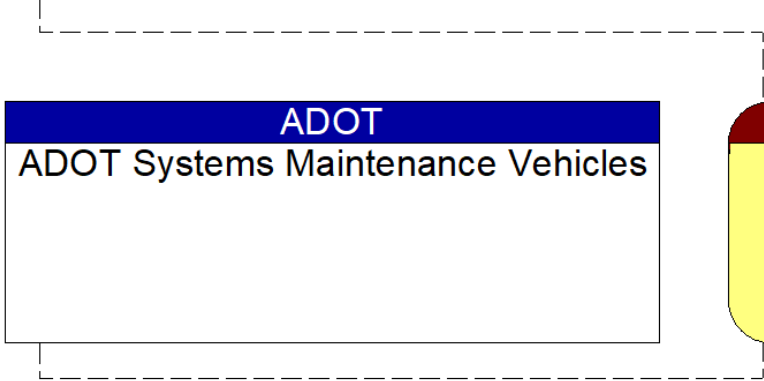
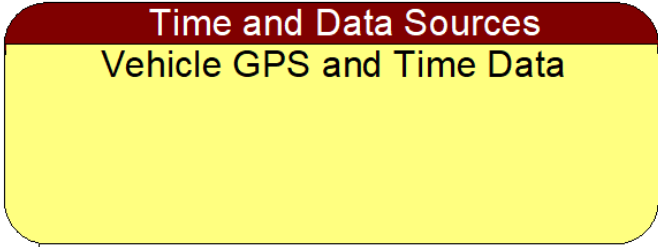
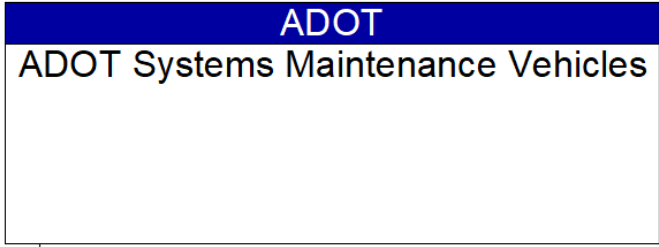
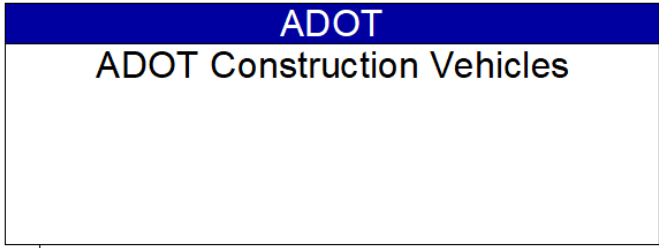

----- **Planned**

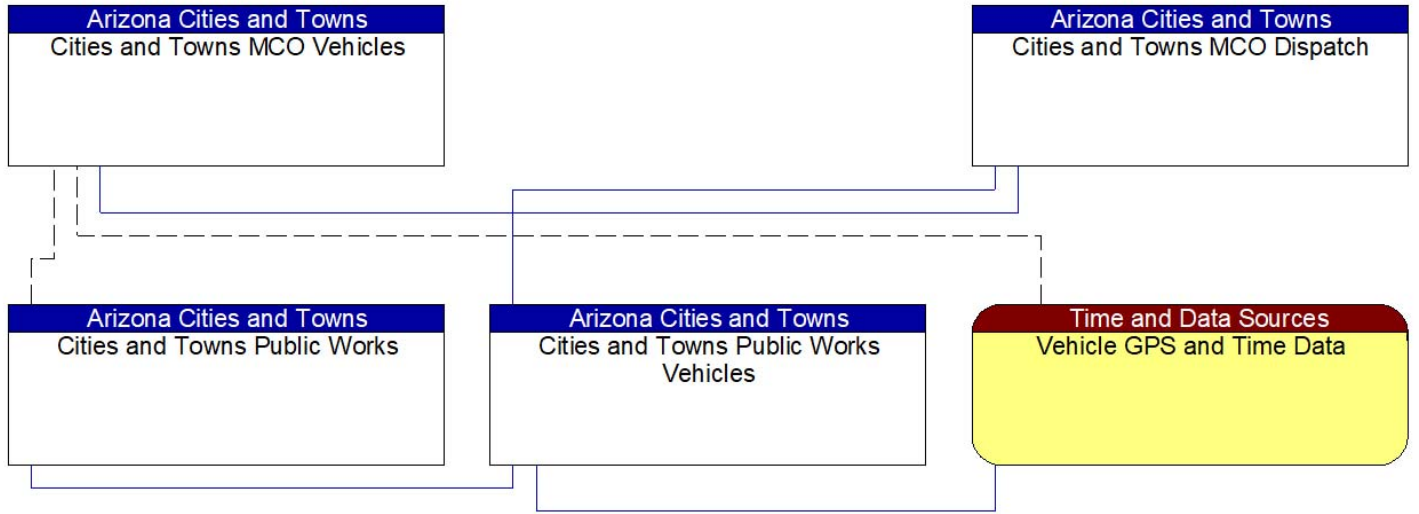

_____ Existing
 - - - - - Planned

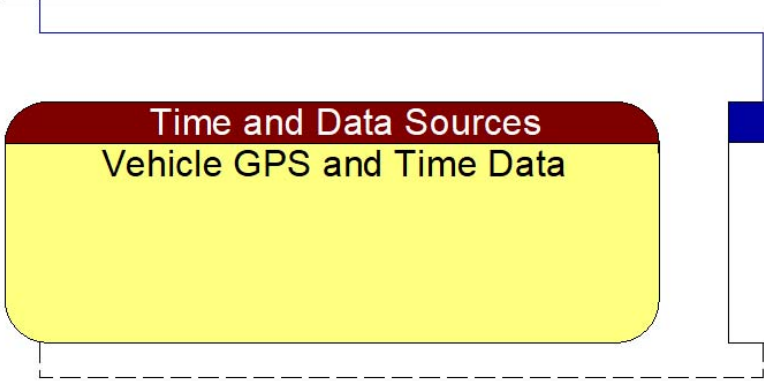
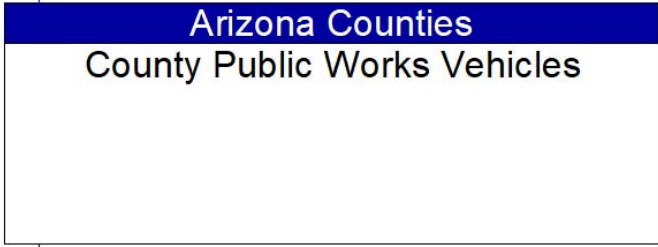
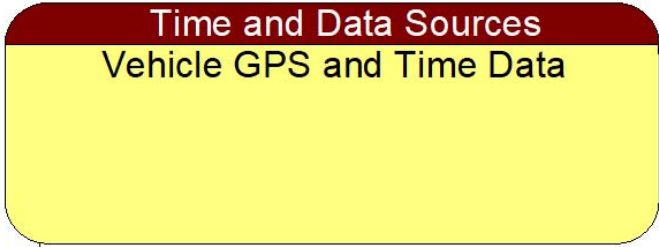
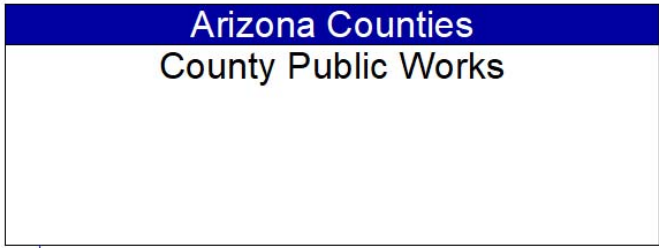

———— Existing
----- Planned

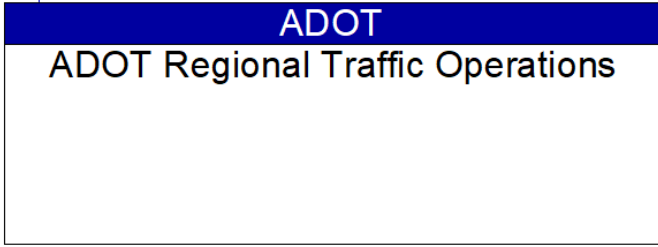
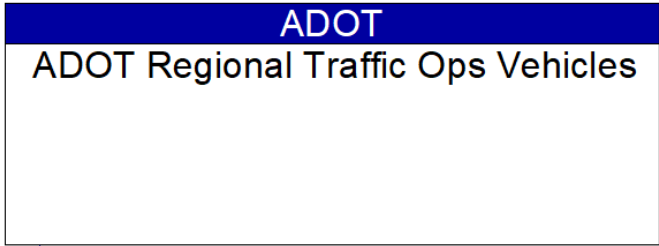

Existing

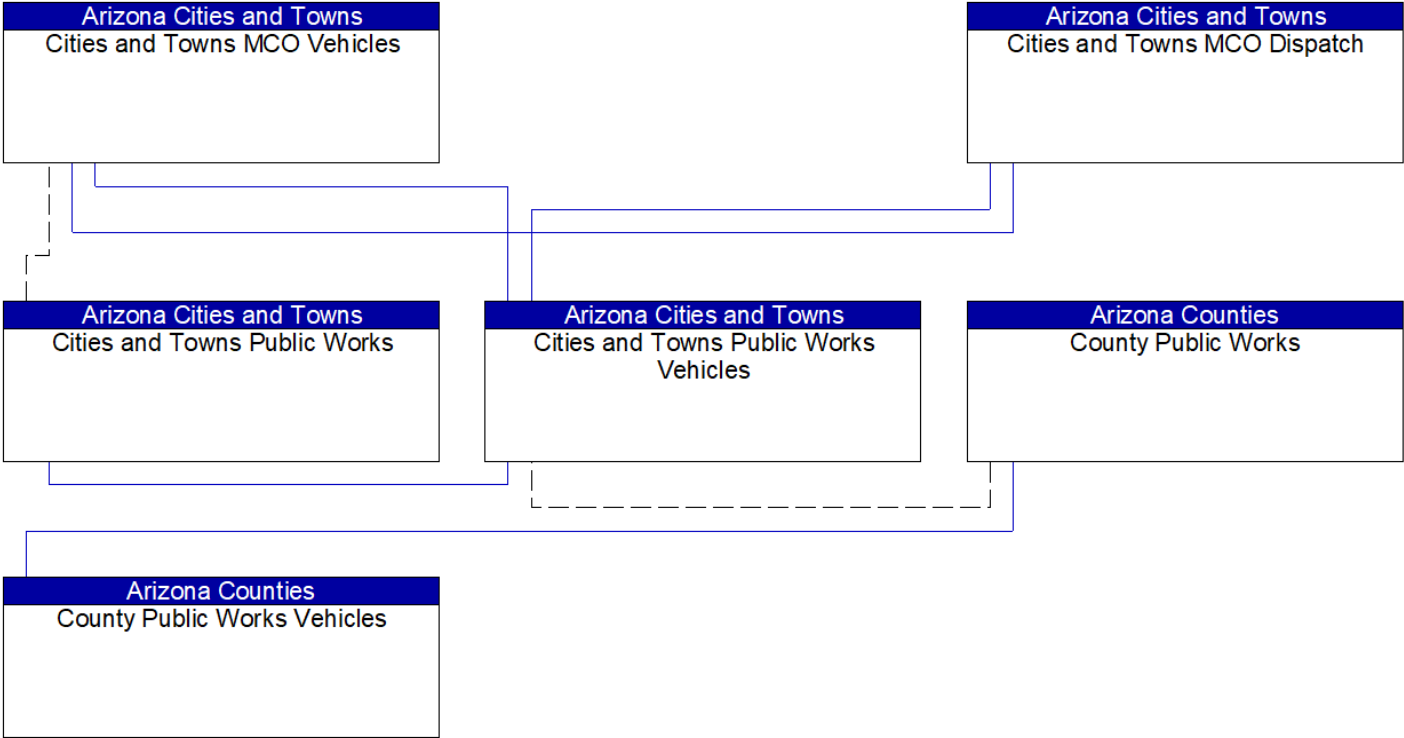

— Existing
 - - - Planned

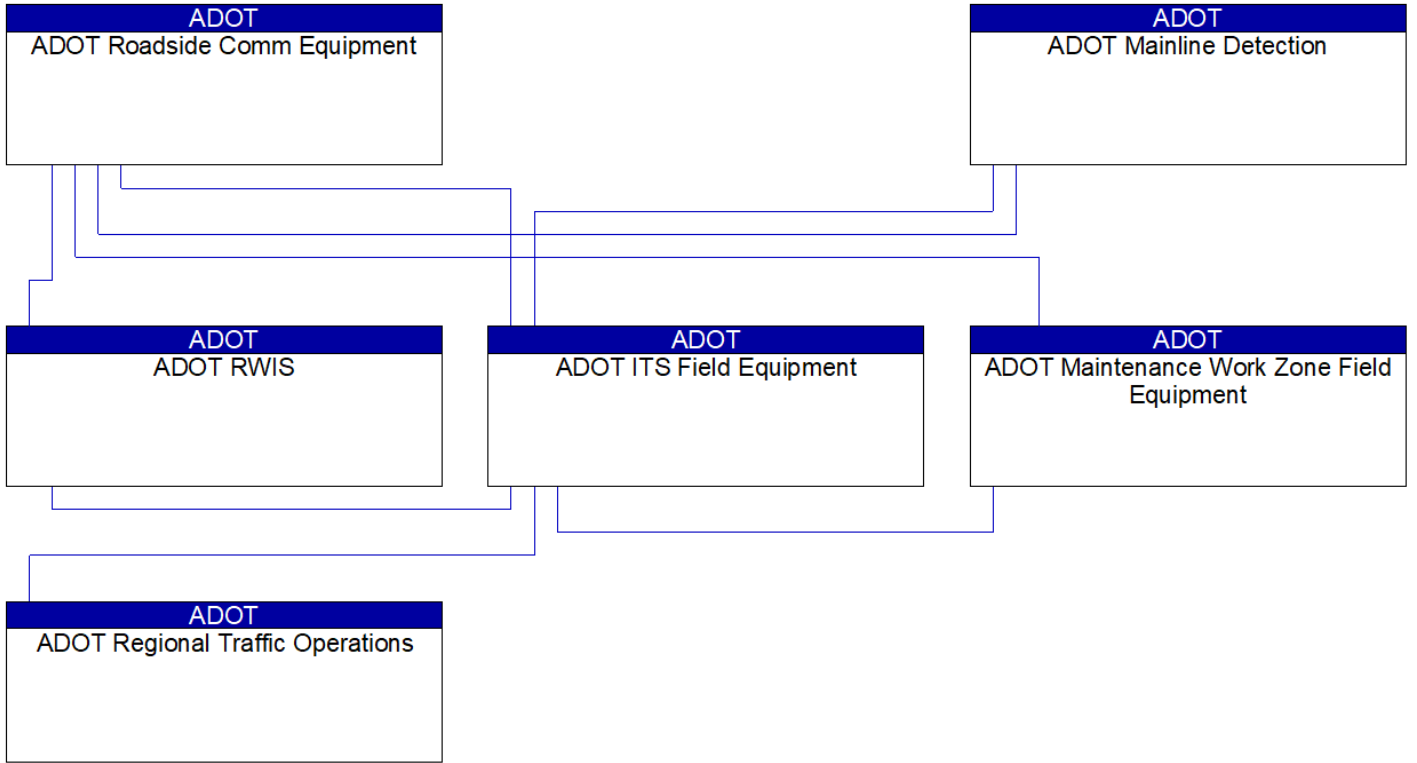

Existing

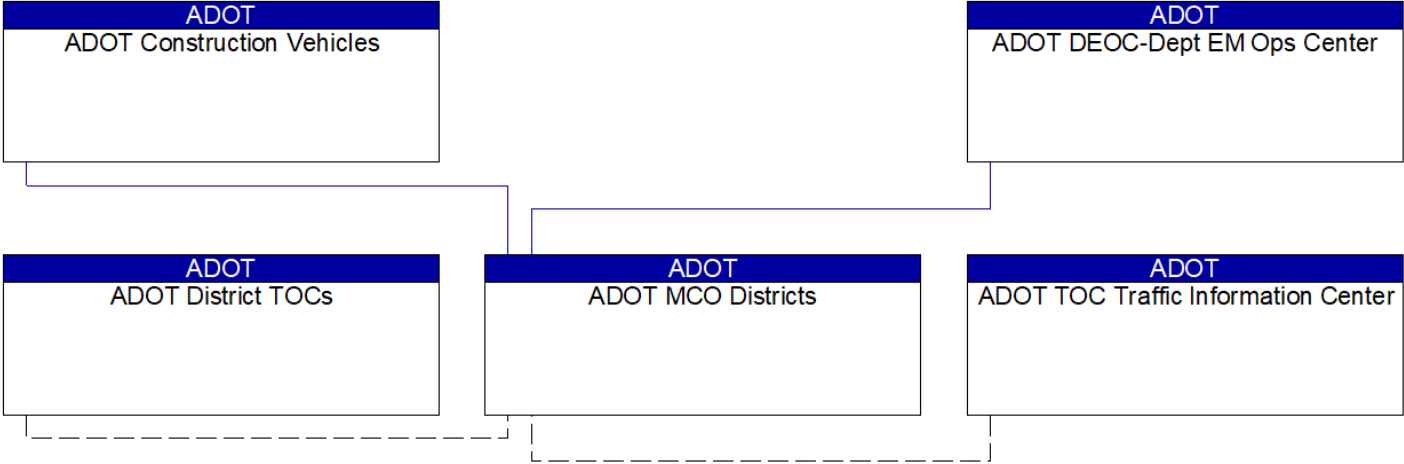

———— Existing
----- Planned

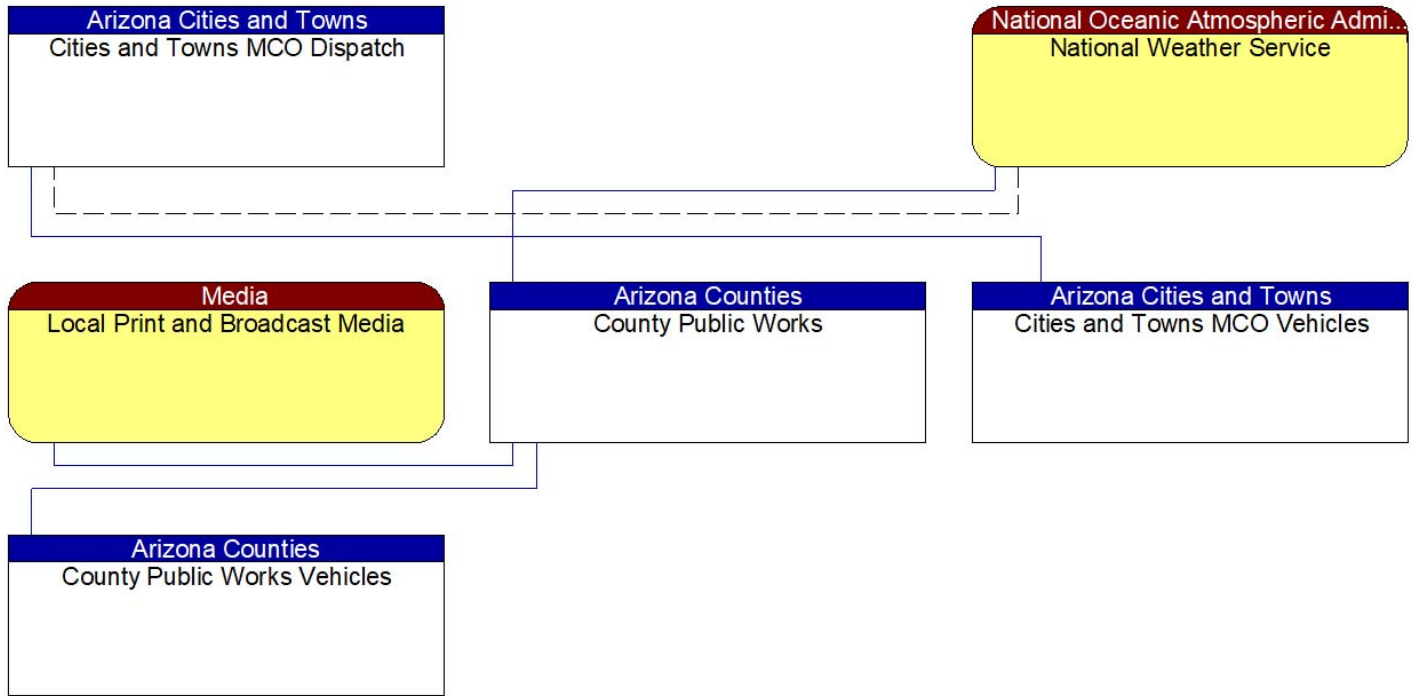

— Existing
 - - - Planned

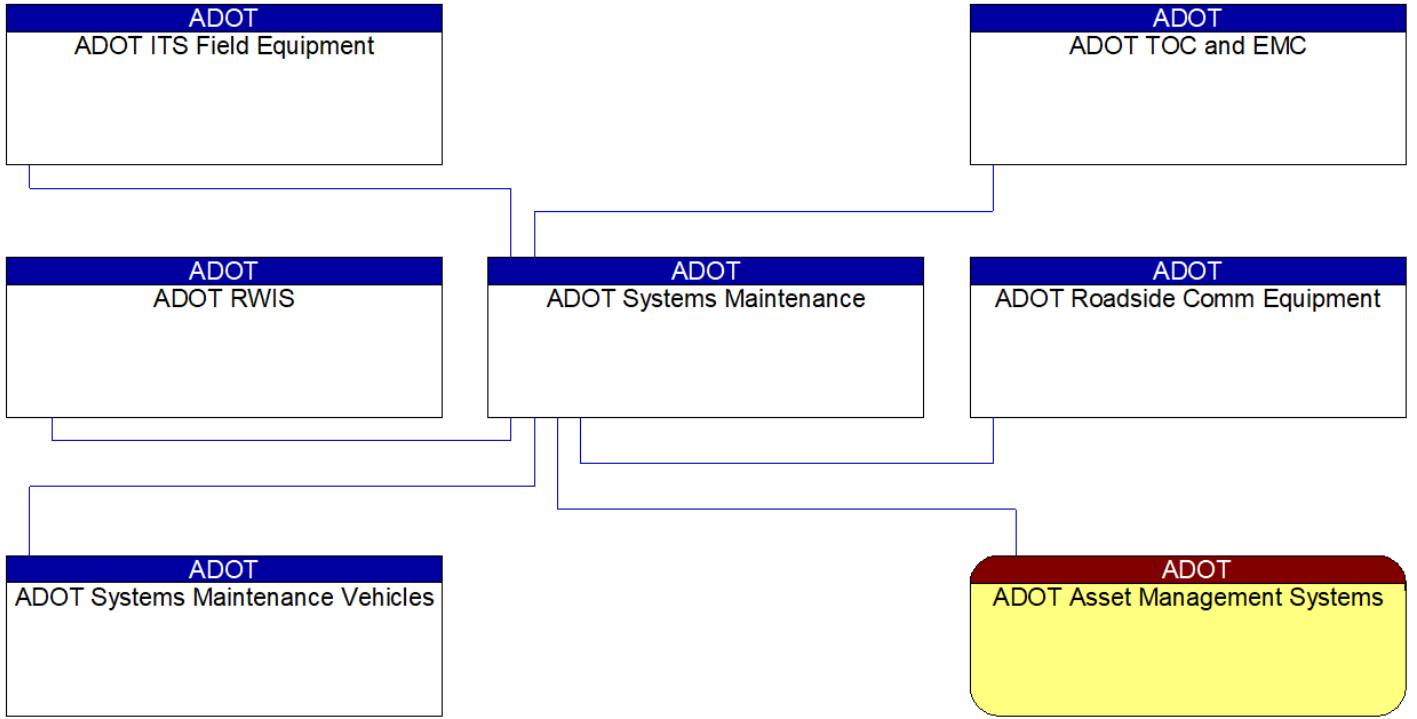

Existing

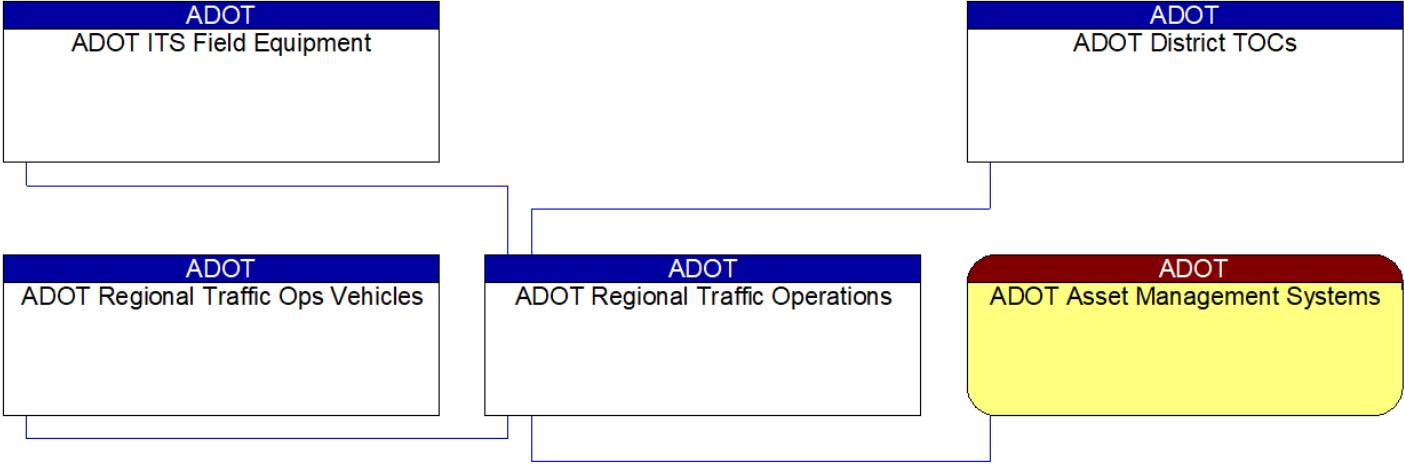

Existing

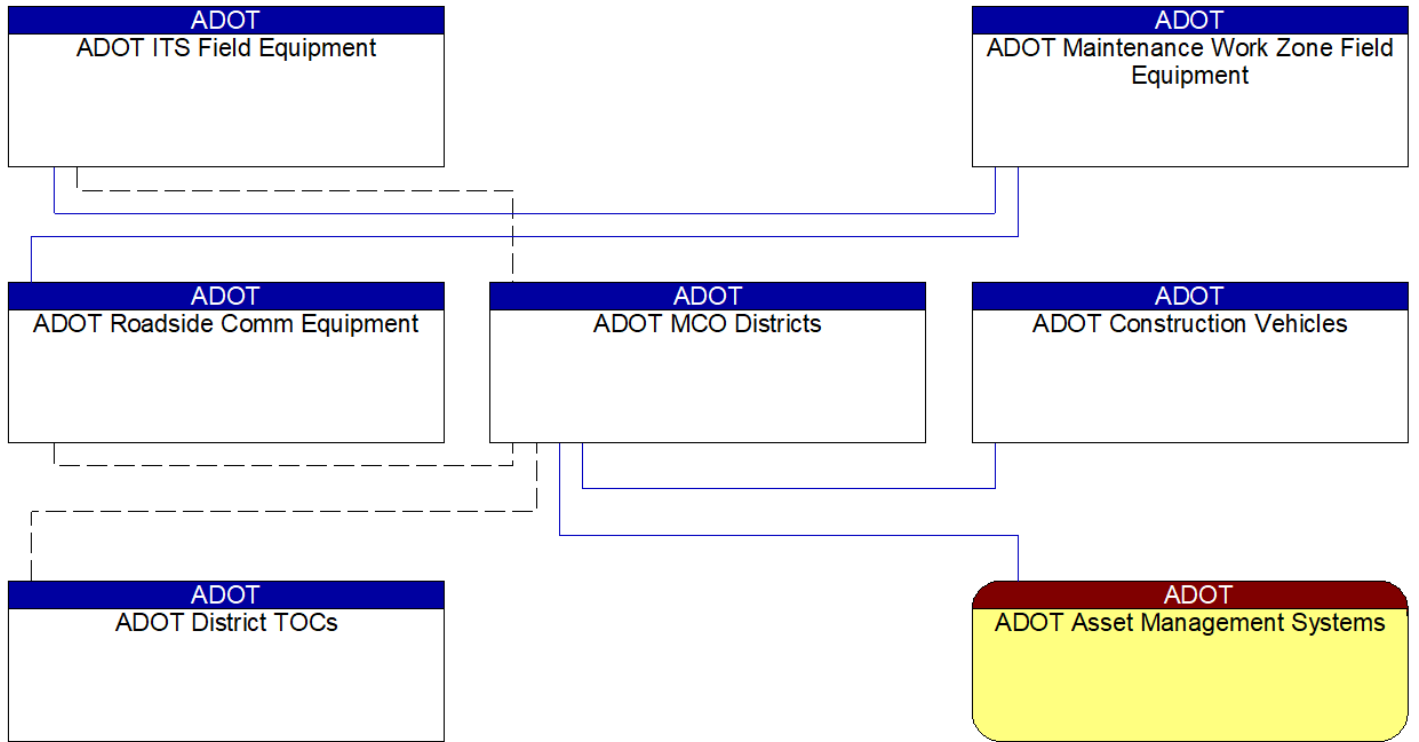

— Existing
 - - - Planned

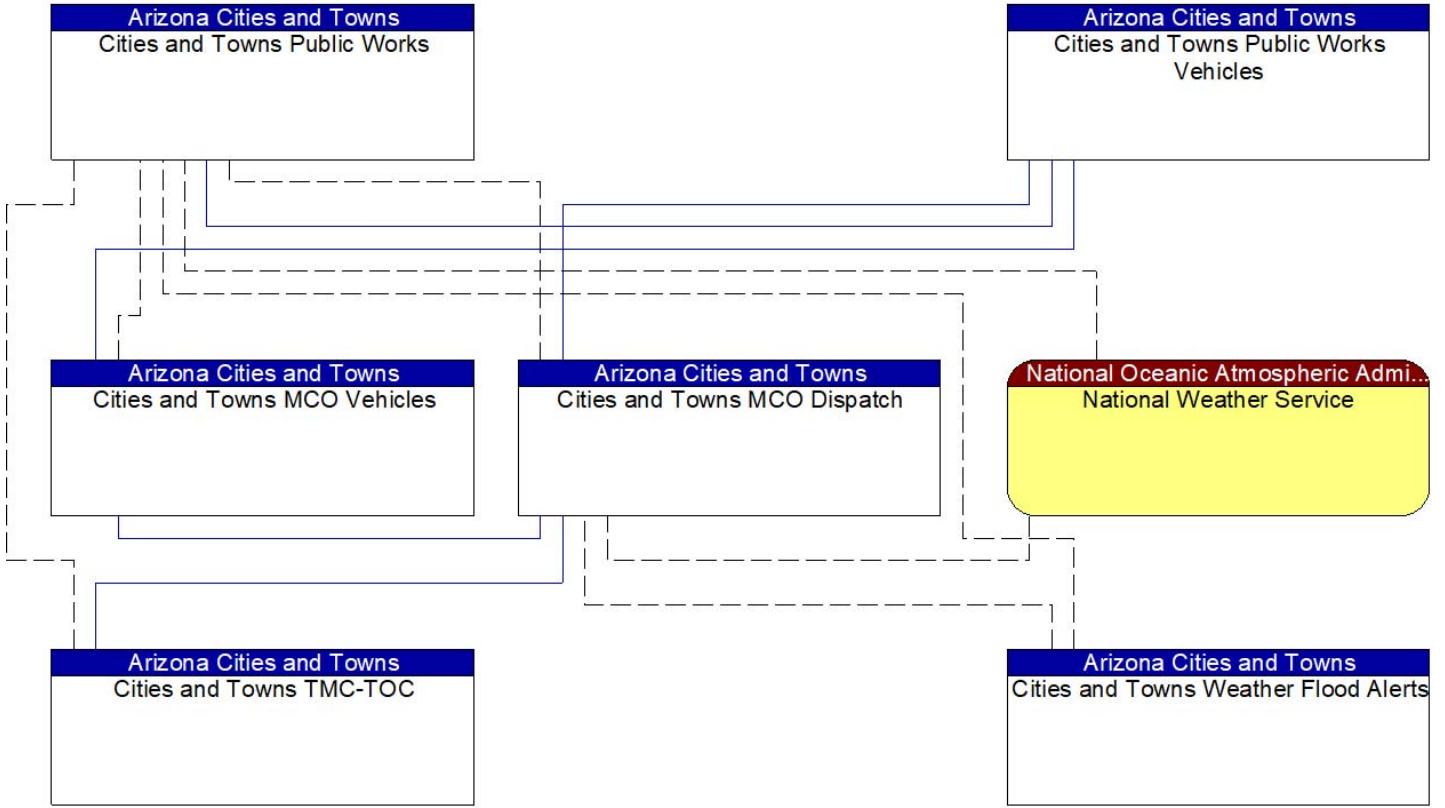

— Existing
 - - - Planned

National Oceanic Atmospheric Admi...
National Weather Service

Arizona Counties
County Flood Warning System

Arizona Counties
County ITS Field Equipment

Arizona Counties
County Public Works

Arizona Counties
County Public Works Vehicles

Arizona Counties
County TMC-TOC

Existing
Planned

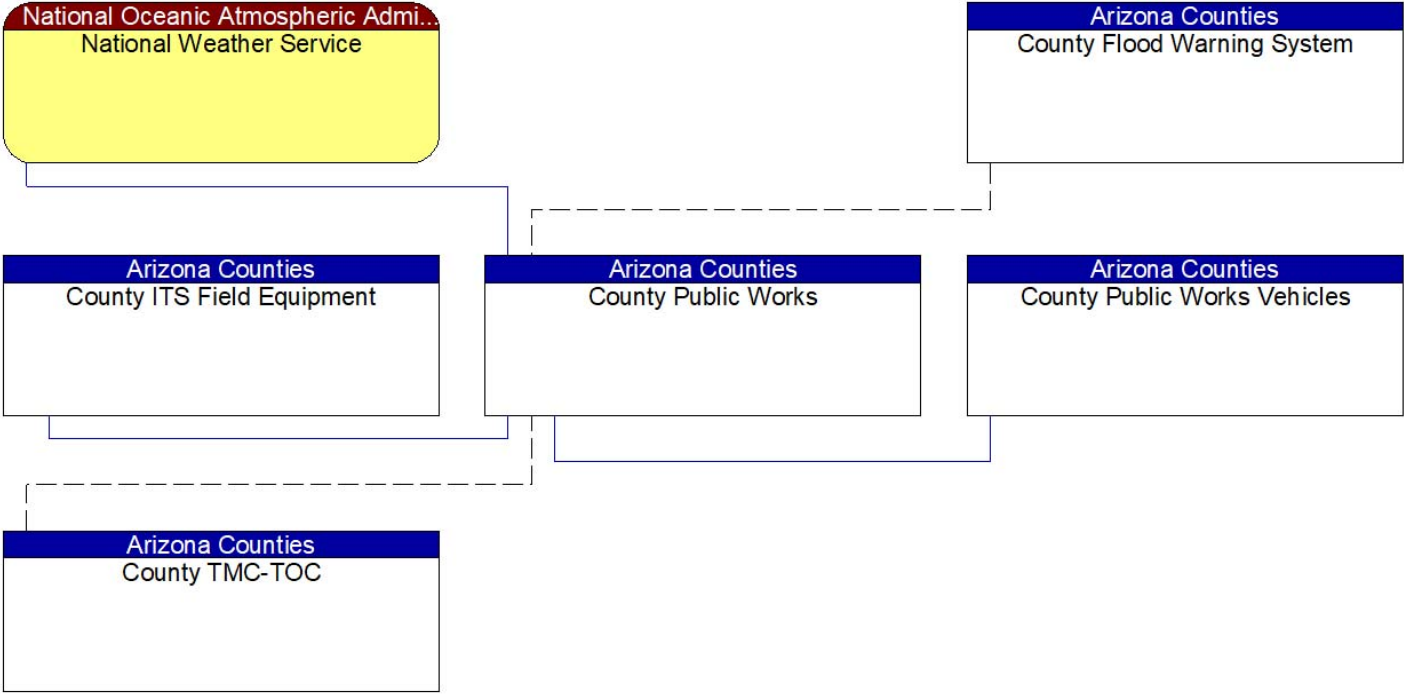

Tribal Governments - Statewide
Tribal ITS Field Equipment

Tribal Governments - Statewide
Tribal MCO Vehicles

Tribal Governments - Statewide
Tribal TMC-TOC-TIC

Tribal Governments - Statewide
Tribal MCO Dispatch

———— Existing
----- Planned

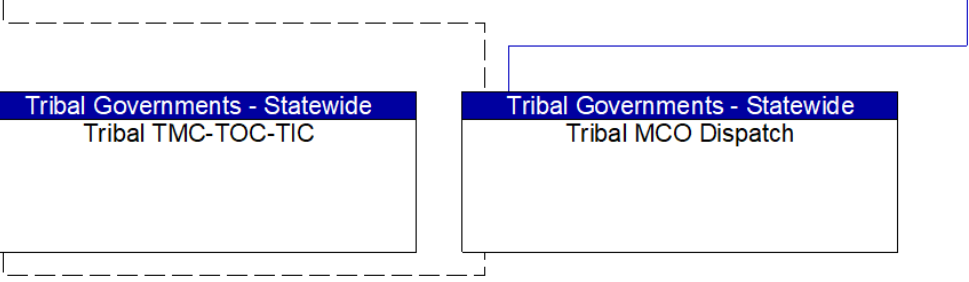

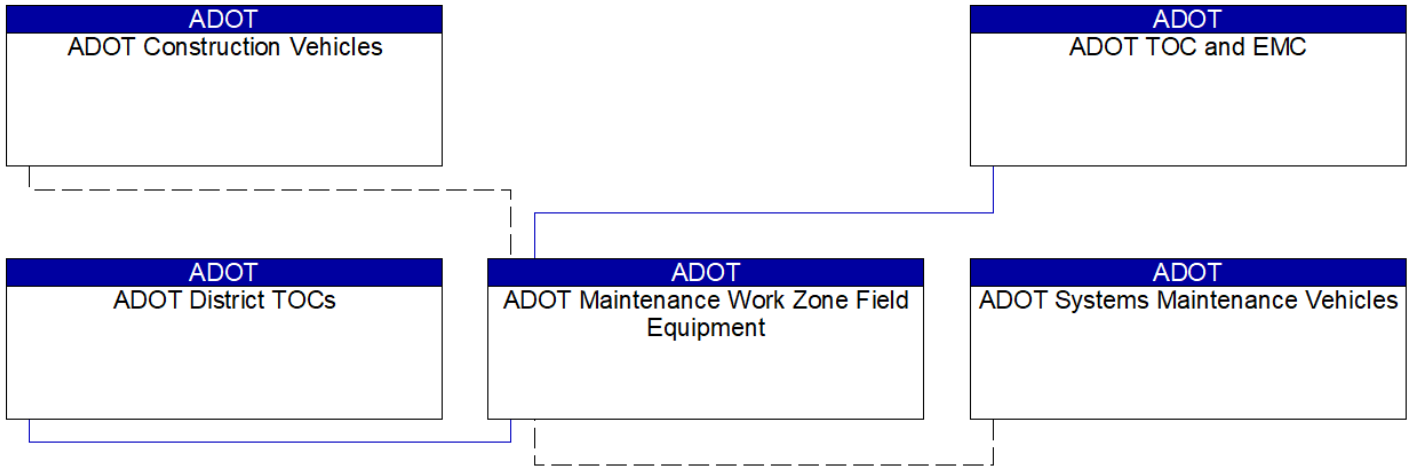

———— Existing
- - - - - Planned

Arizona Cities and Towns
Cities and Towns Public Works

Arizona Cities and Towns
Cities and Towns Public Works
Vehicles

Arizona Cities and Towns
Cities and Towns MCO Vehicles

Arizona Cities and Towns
Cities and Towns MCO Dispatch

———— Existing
----- Planned

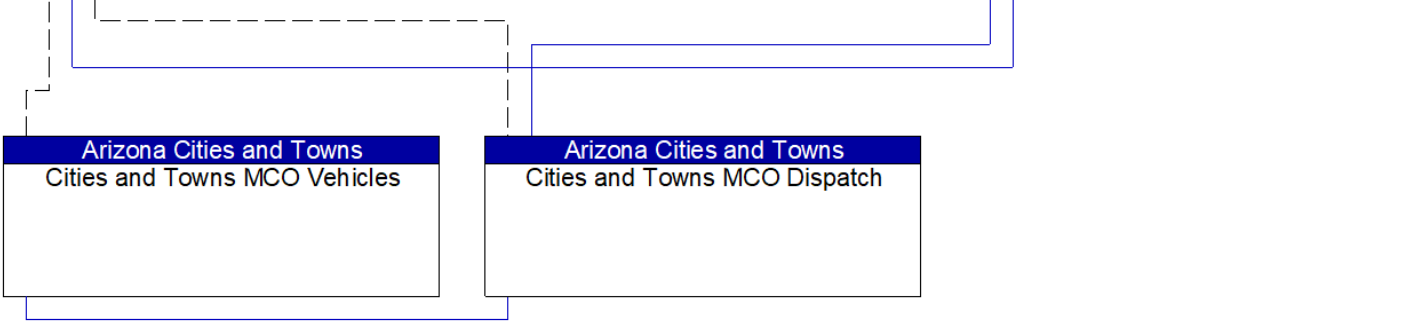

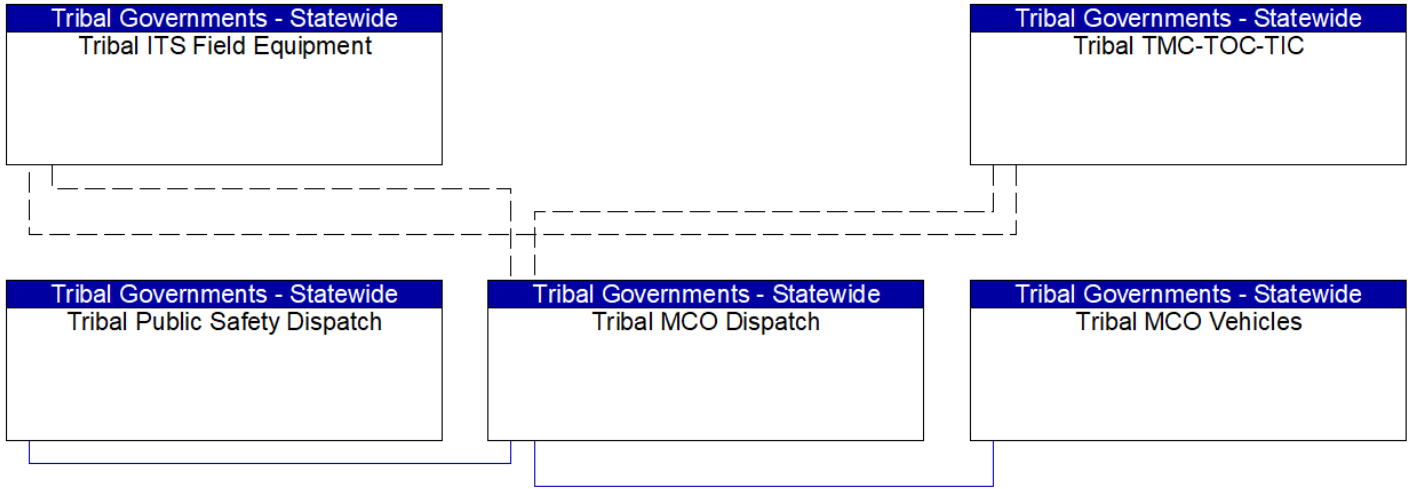

———— Existing
- - - - - Planned

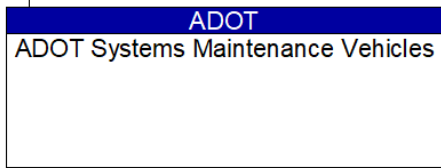
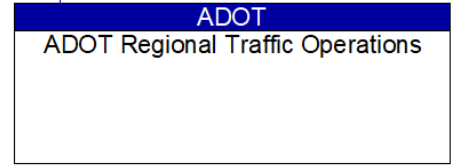
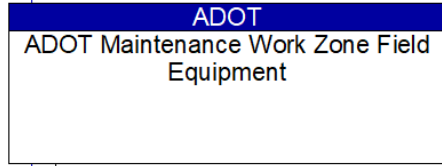
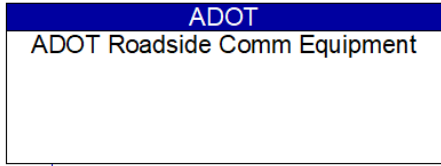
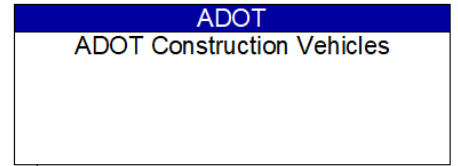
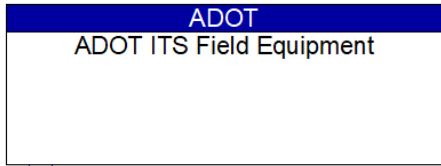

———— Existing
----- Planned

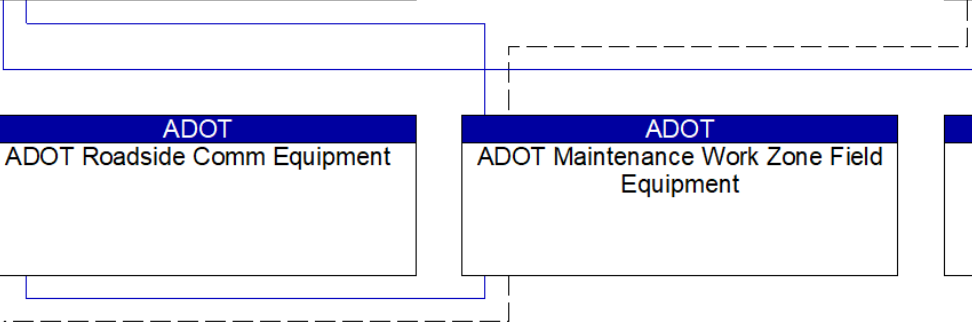

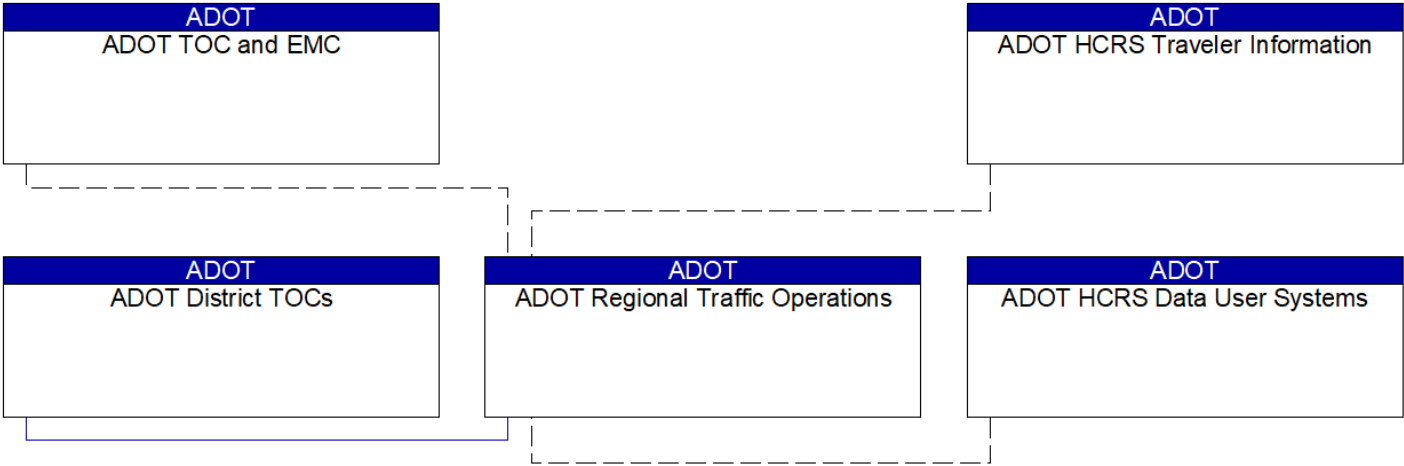

———— Existing
- - - - - Planned

Private Information Service Providers

Public Private Traveler Information

Travelers

Private Vehicle OBE

----- **Planned**

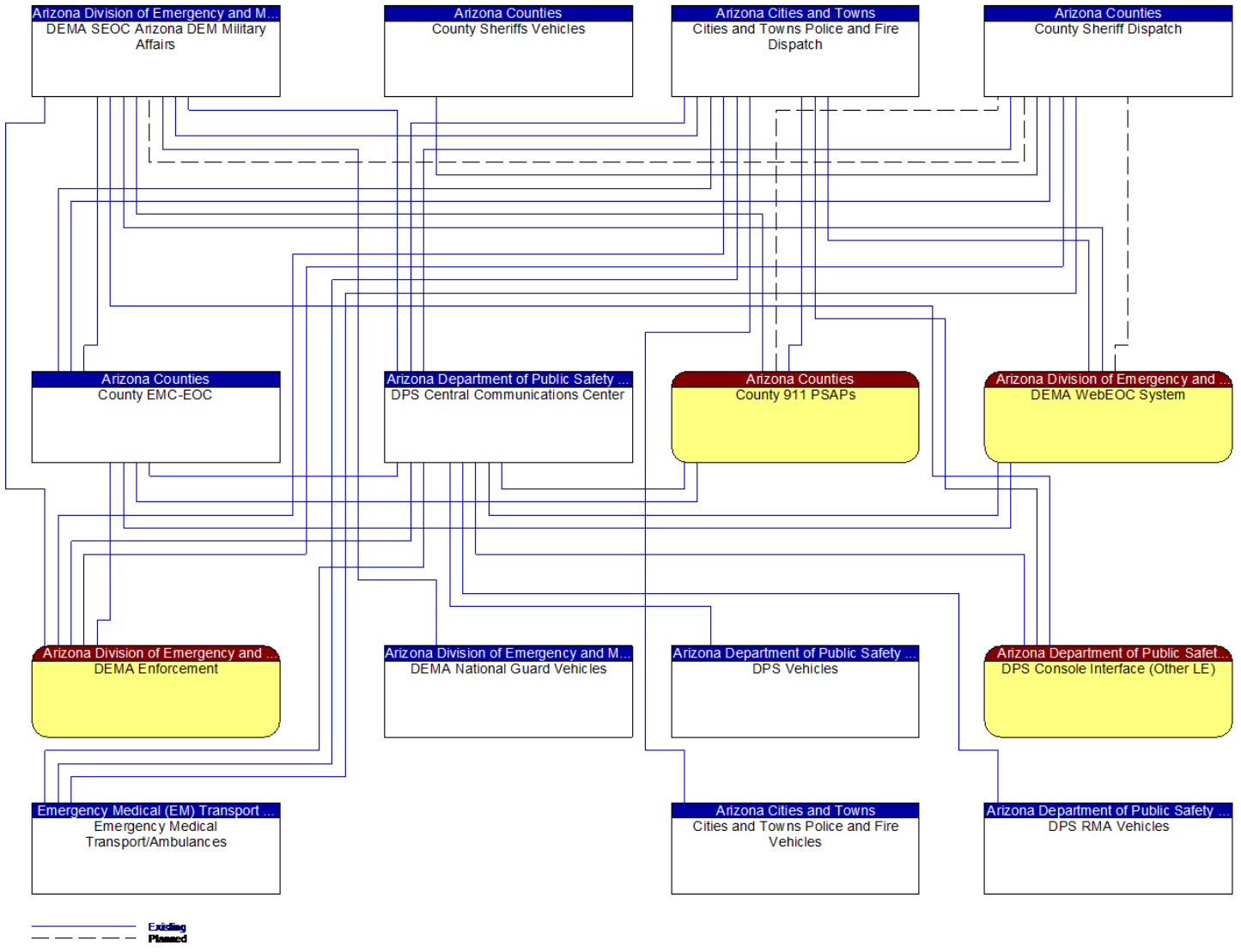

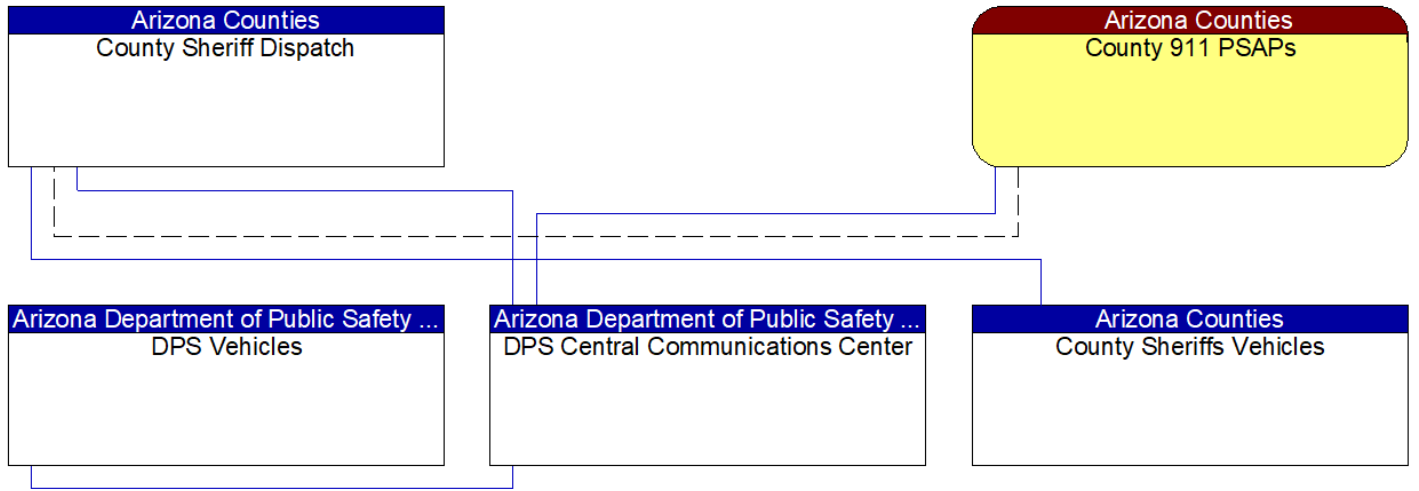

_____ Existing
 - - - - - Planned

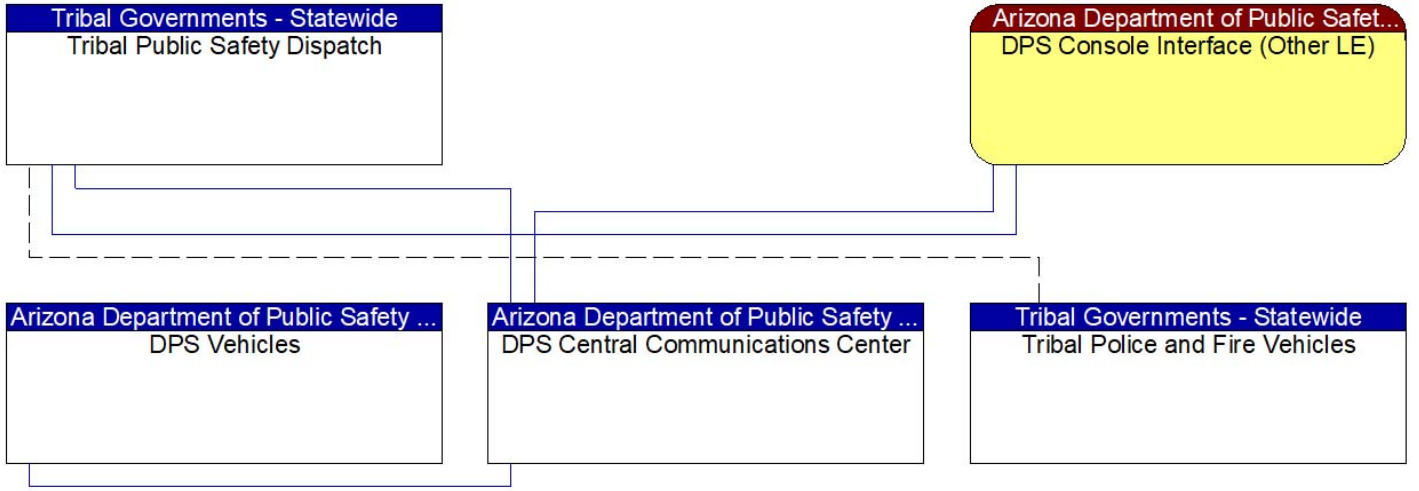

US Customs and Border Protection (...)
US Border Patrol Dispatch

US Customs and Border Protection (...)
US Border Patrol Vehicles

———— Existing

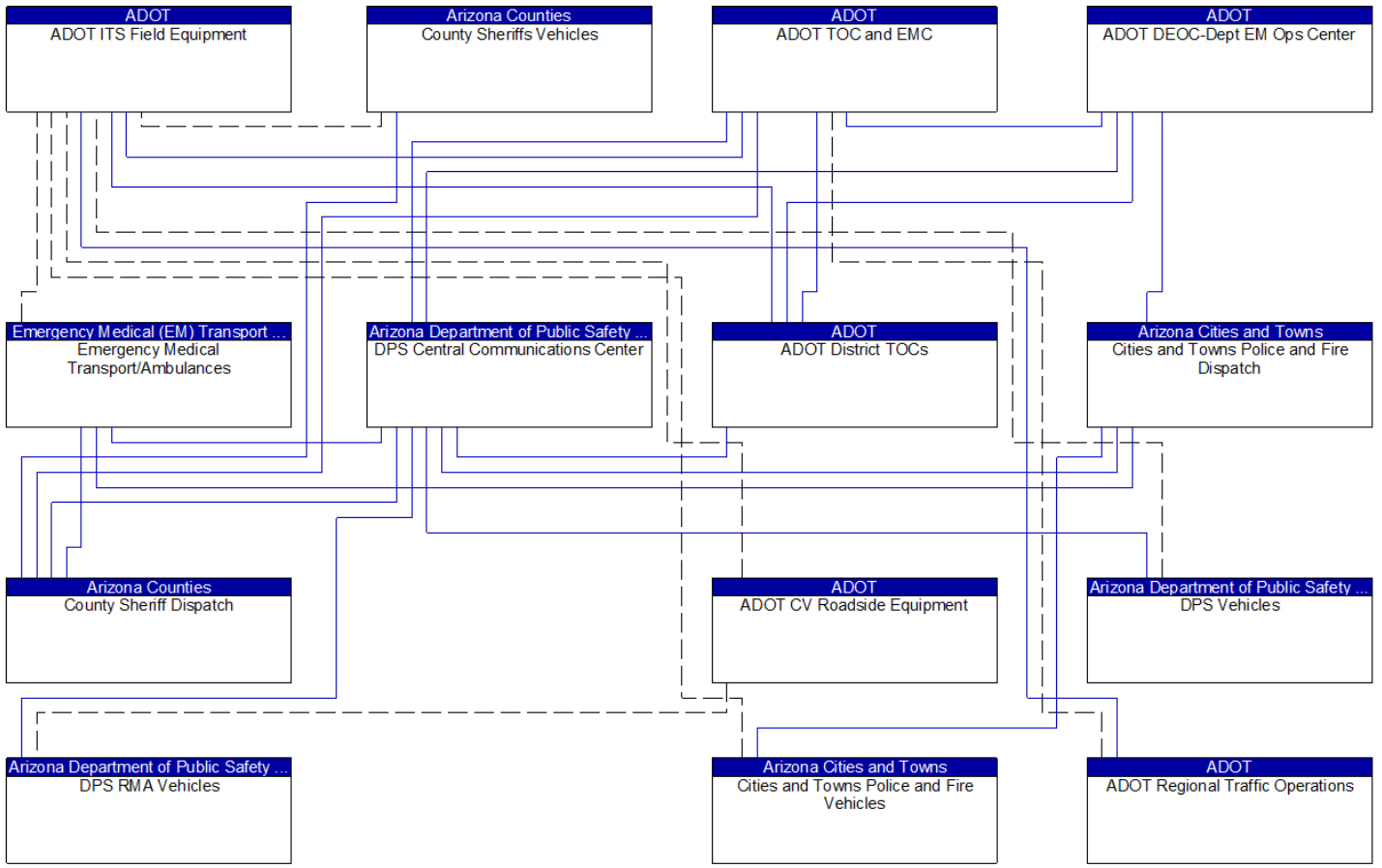

Arizona Cities and Towns
Cities and Towns Police and Fire
Vehicles

Arizona Counties
County ITS Field Equipment

Arizona Counties
County Sheriffs Vehicles

Arizona Cities and Towns
Cities and Towns ITS Field Equipment

----- **Planned**

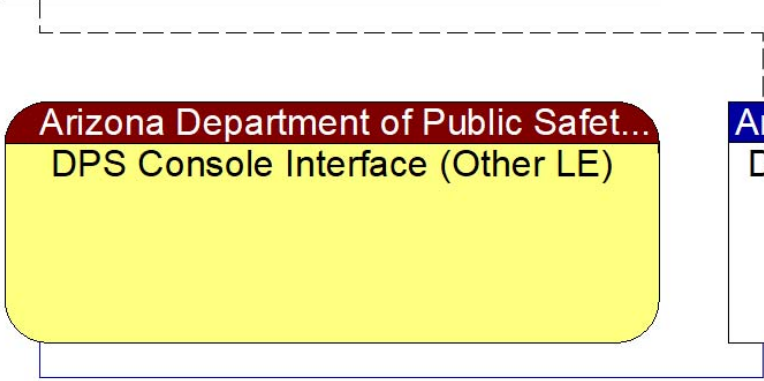
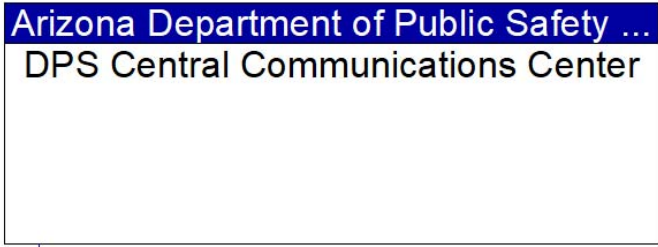
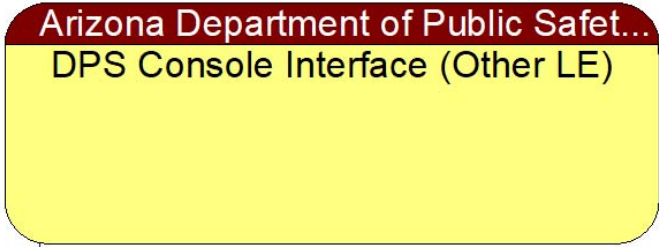
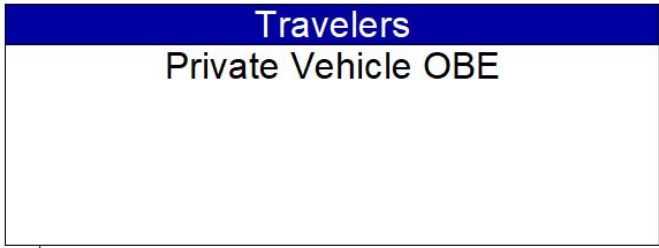

———— Existing
----- Planned

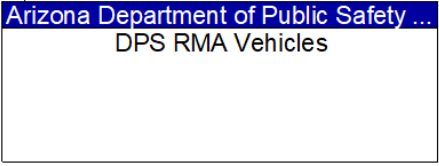
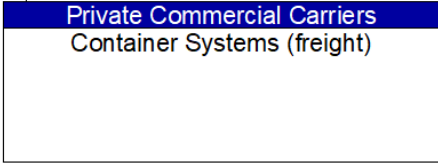
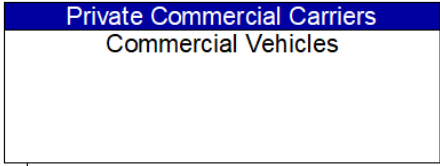
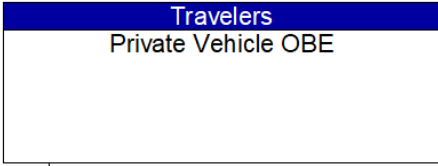

----- **Planned**



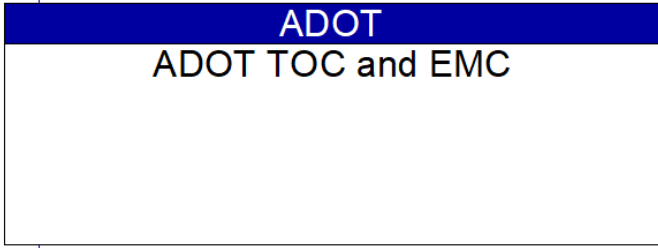
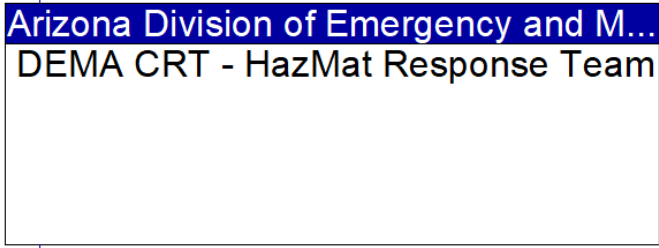
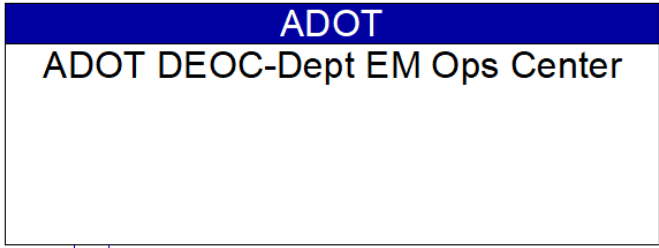

Existing

Arizona Department of Public Safety ...
DPS RMA Vehicles

Arizona Department of Public Safety ...
DPS Vehicles

Arizona Department of Public Safety ...
DPS Central Communications Center

Existing

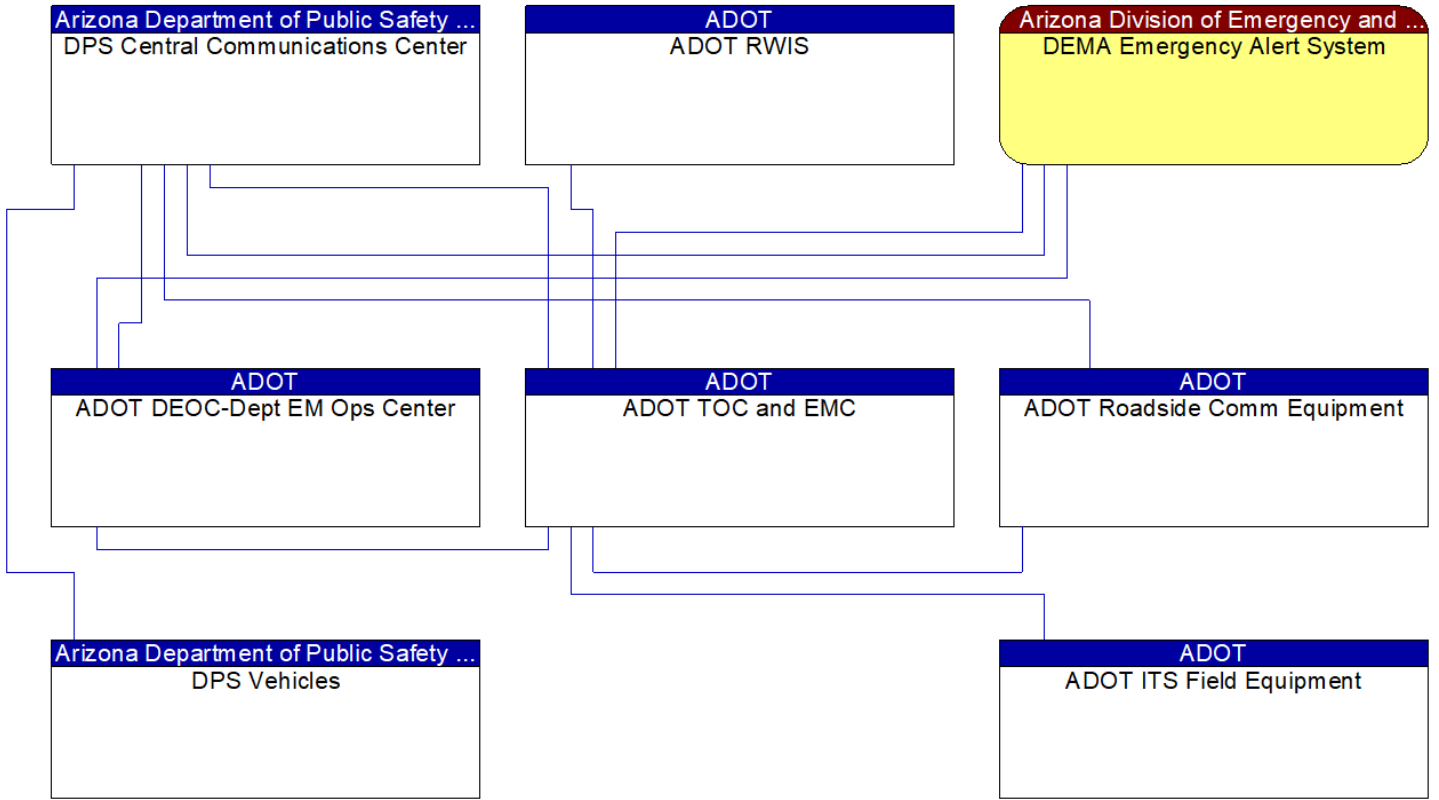

Existing

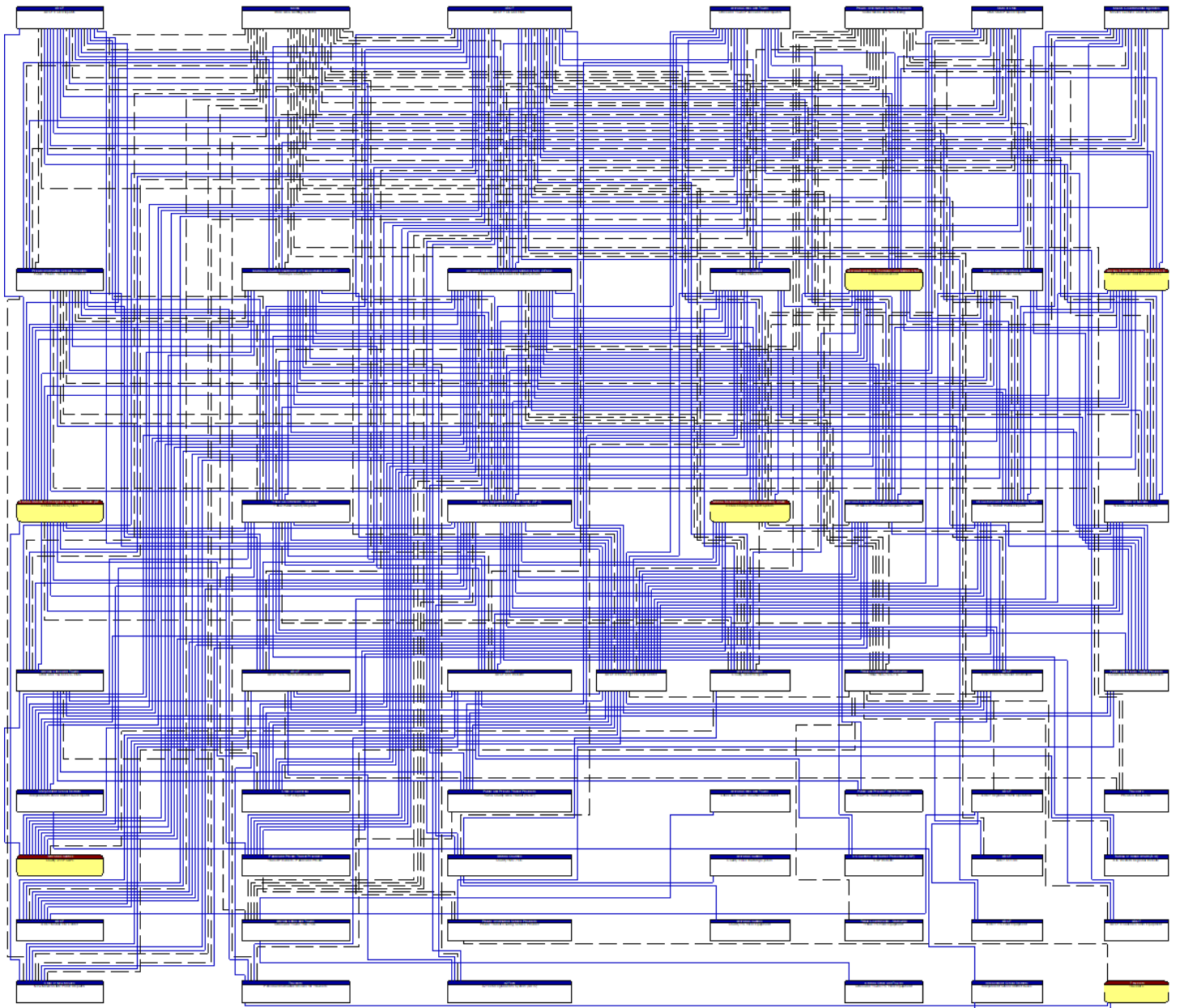

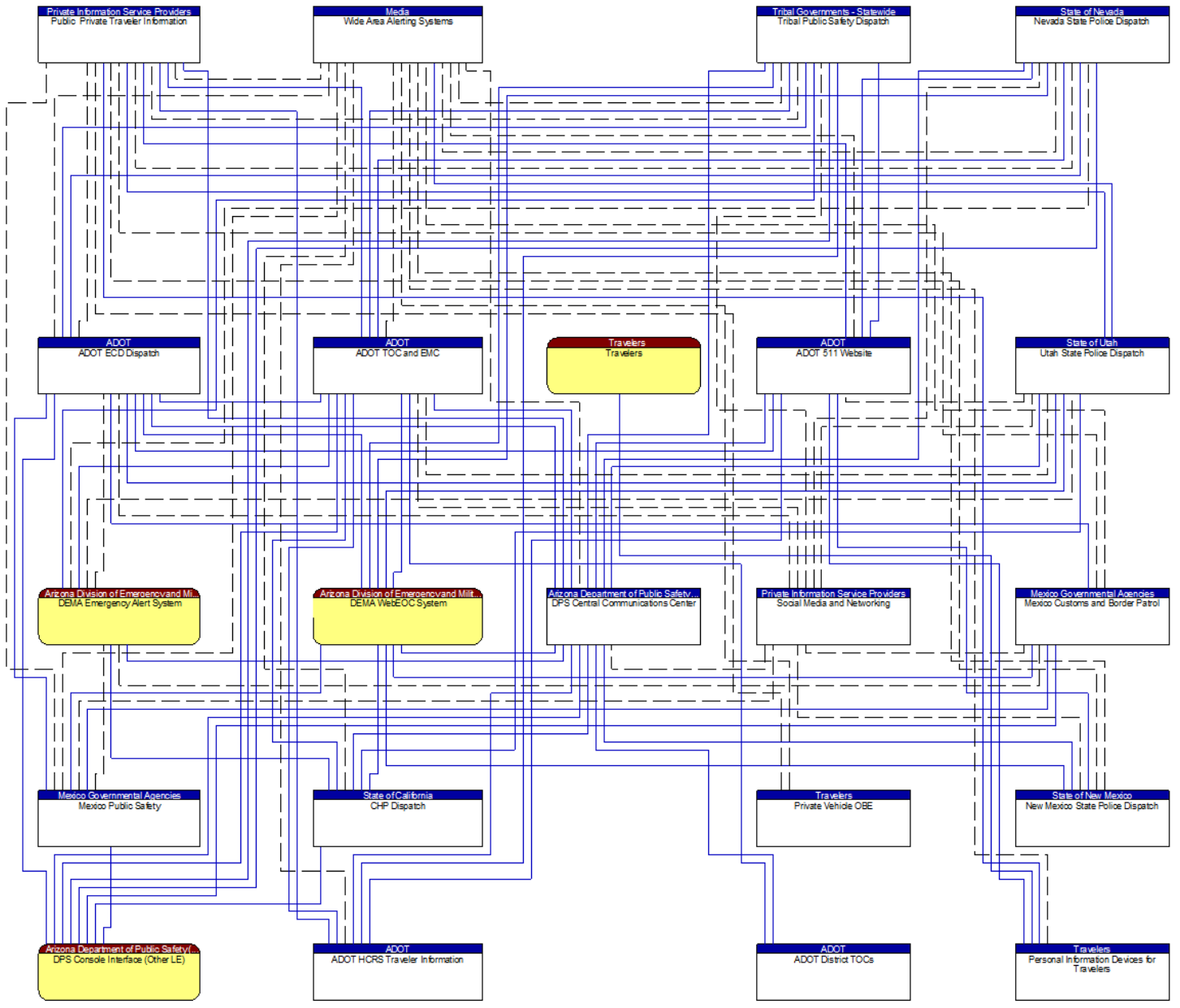

Existing
Planned

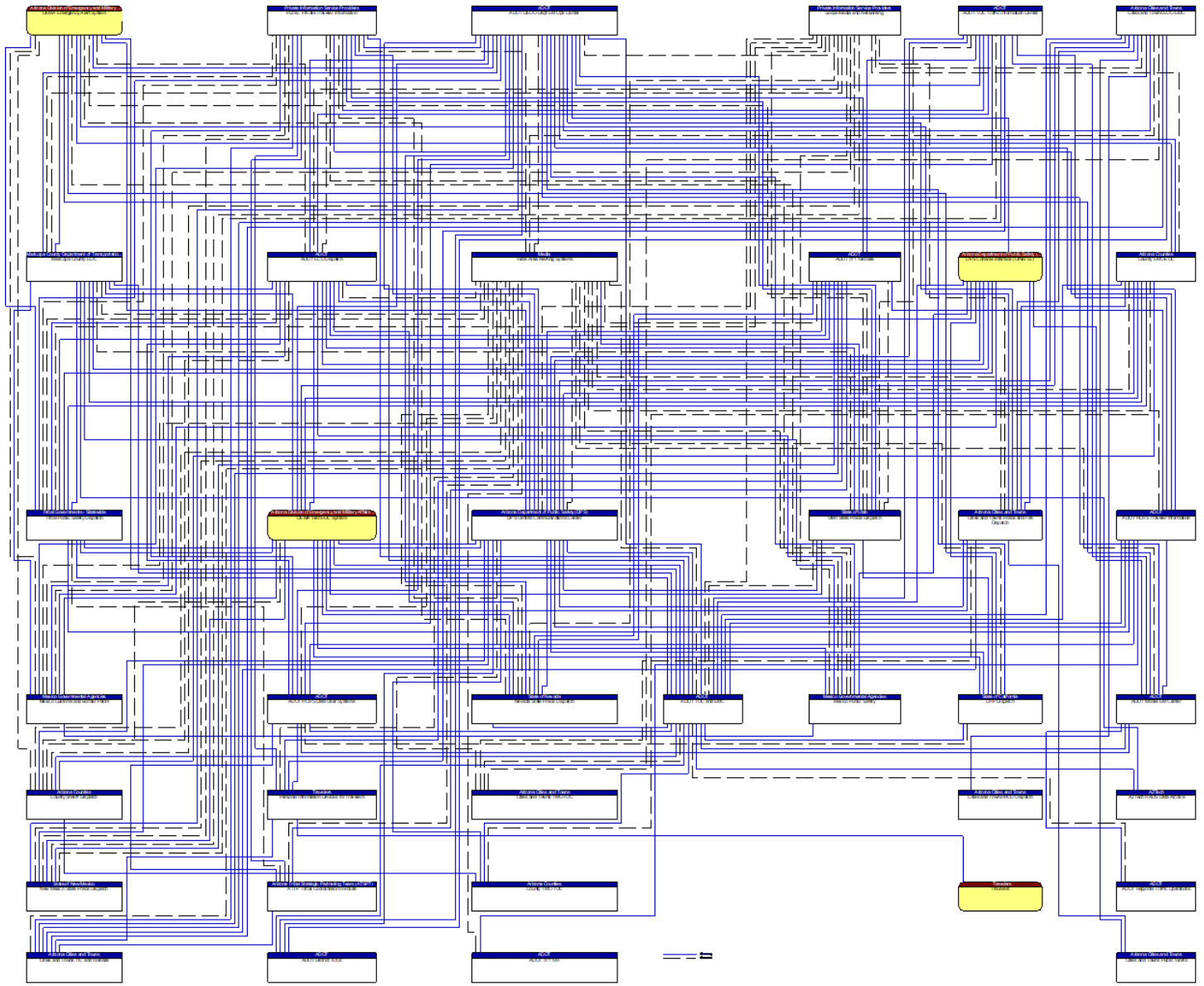

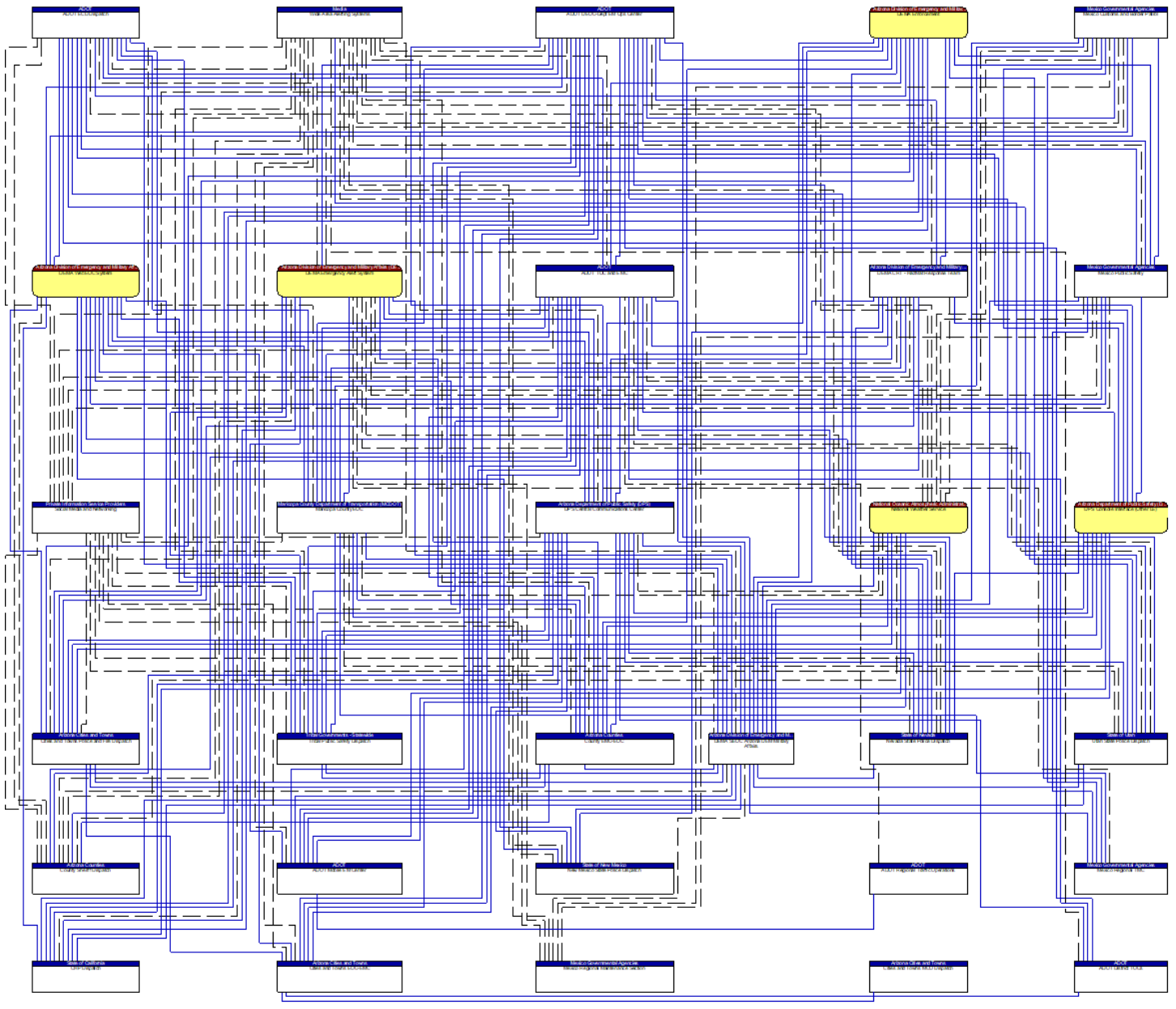

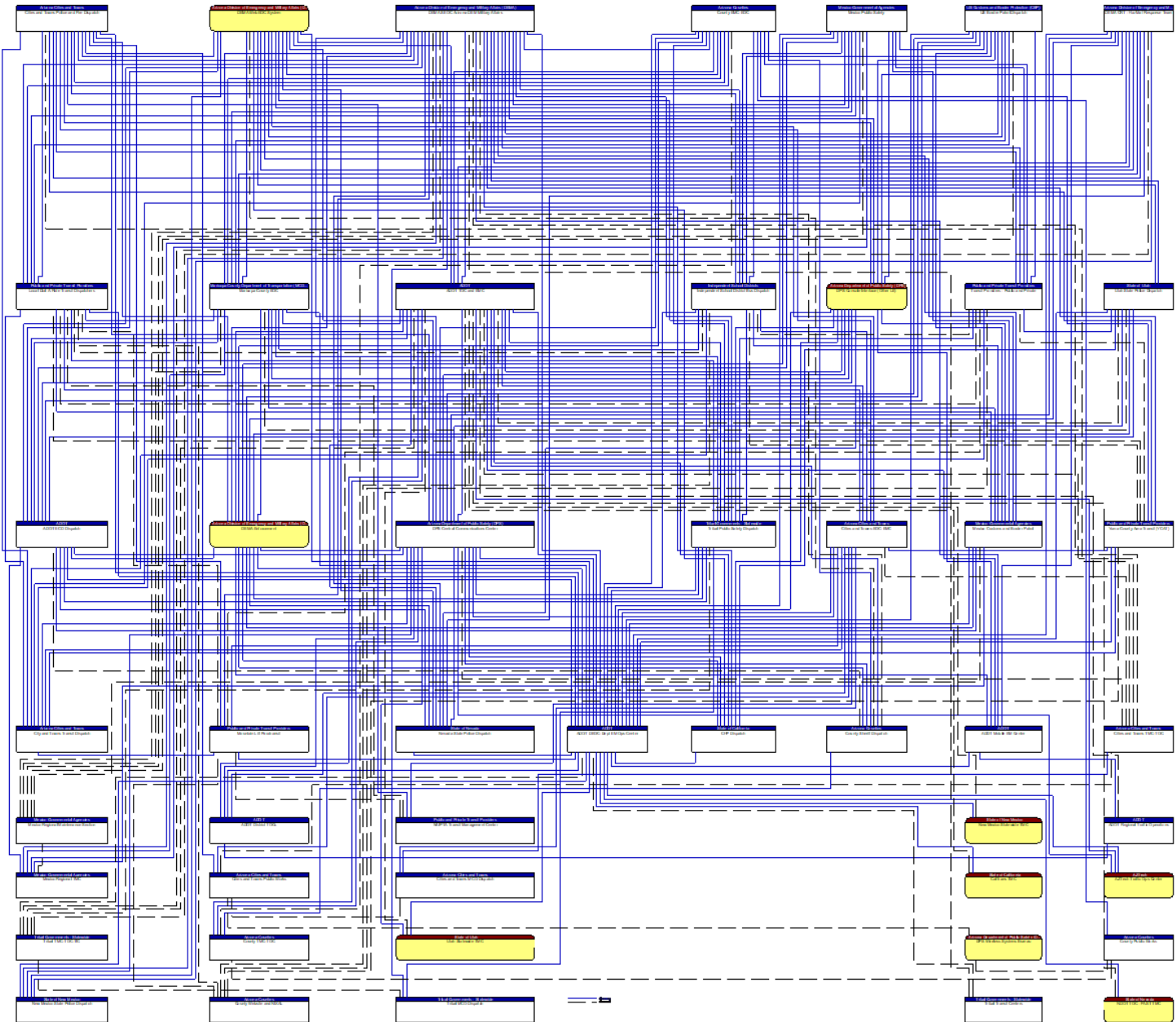

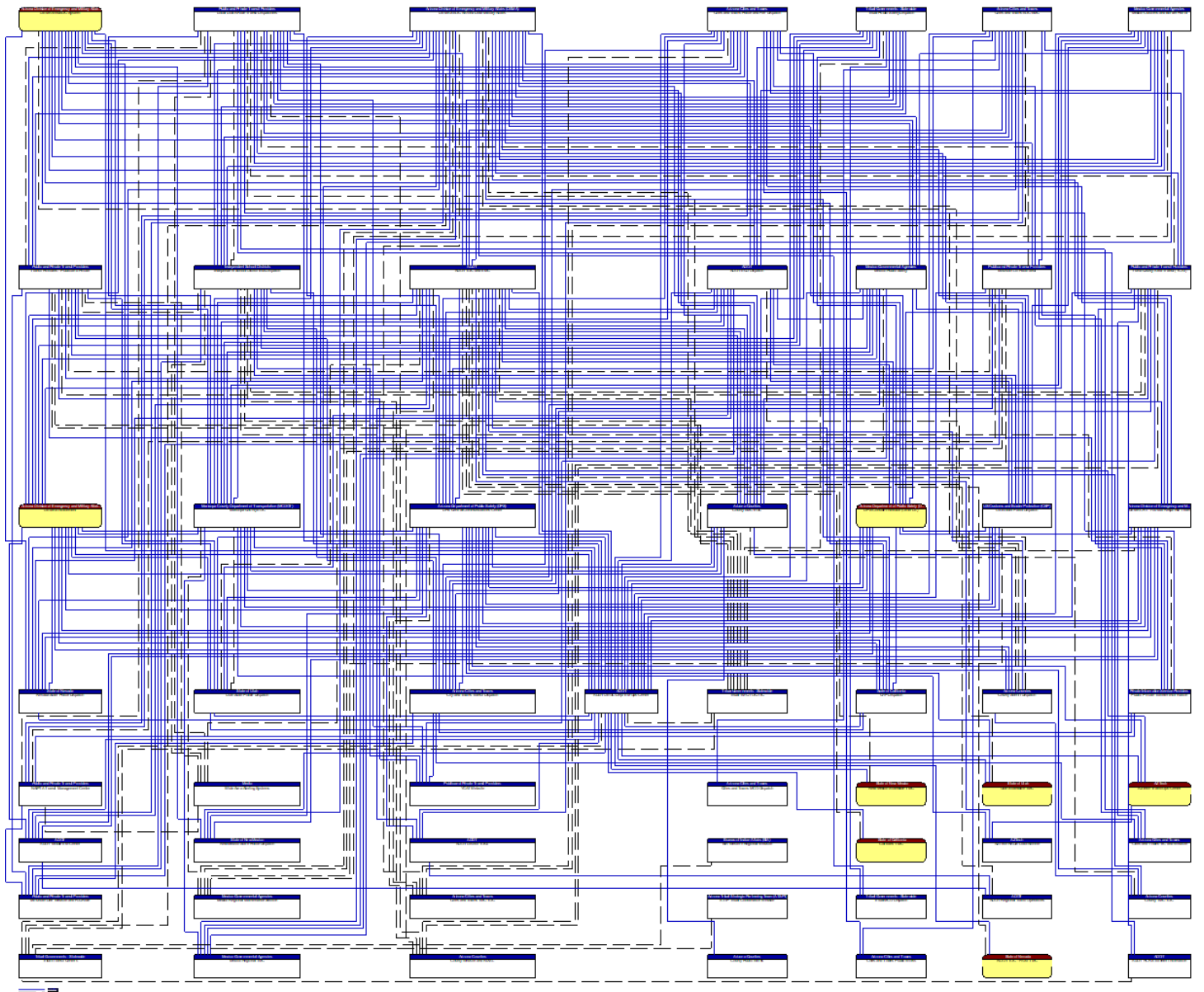

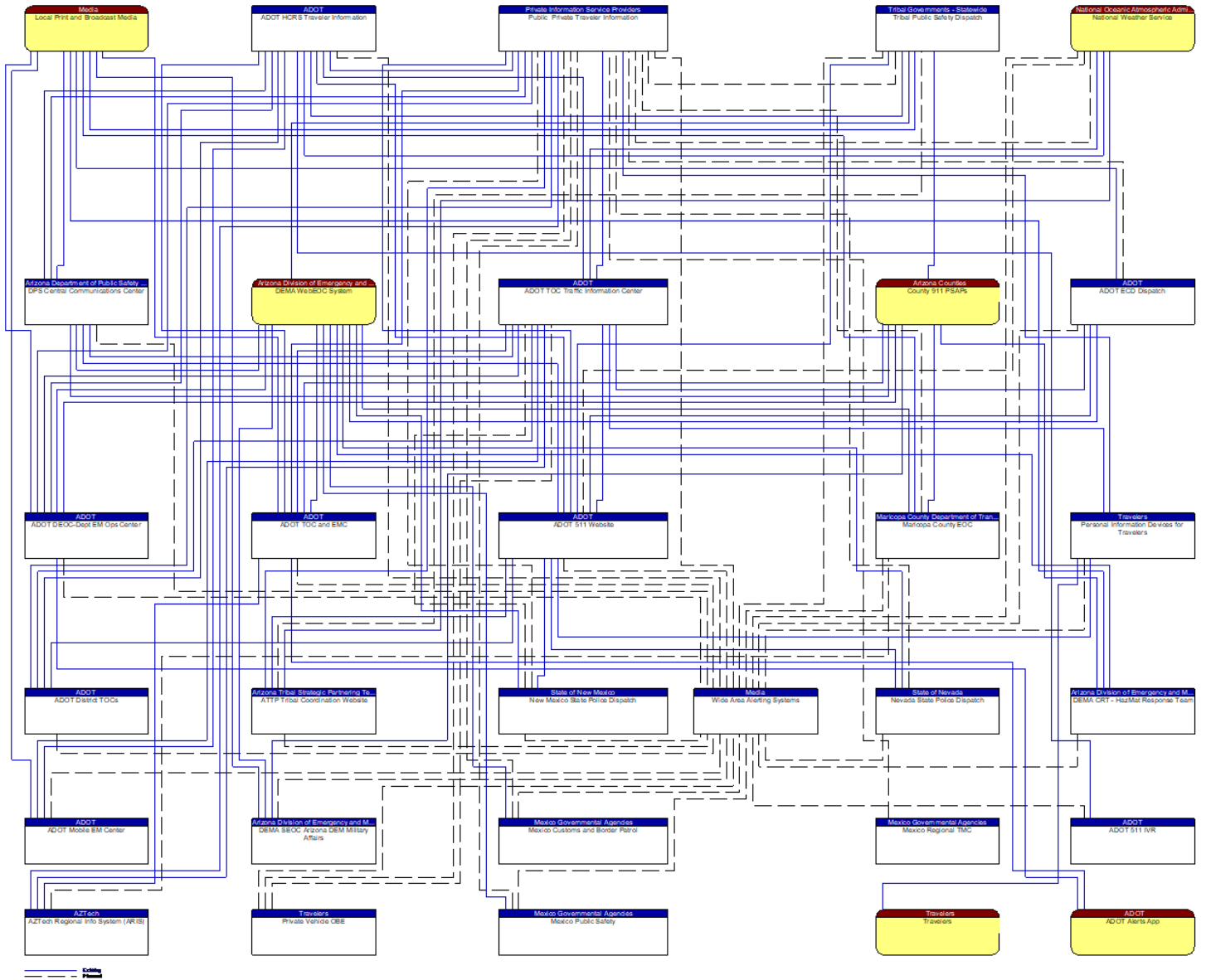

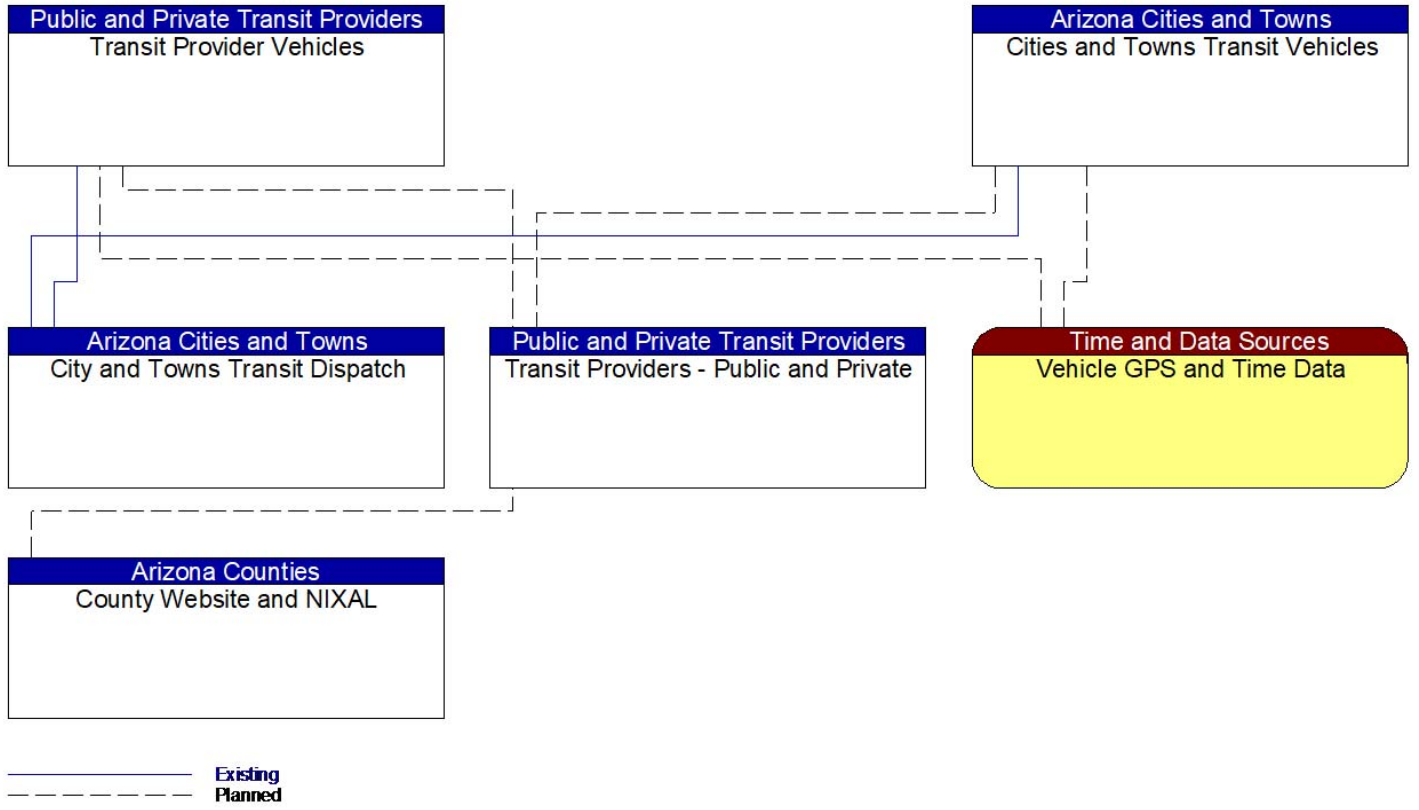

Independent School Districts
Independent School District Bus
Dispatch

Time and Data Sources
Vehicle GPS and Time Data

Independent School Districts
Independent School District Buses

———— Existing
----- Planned

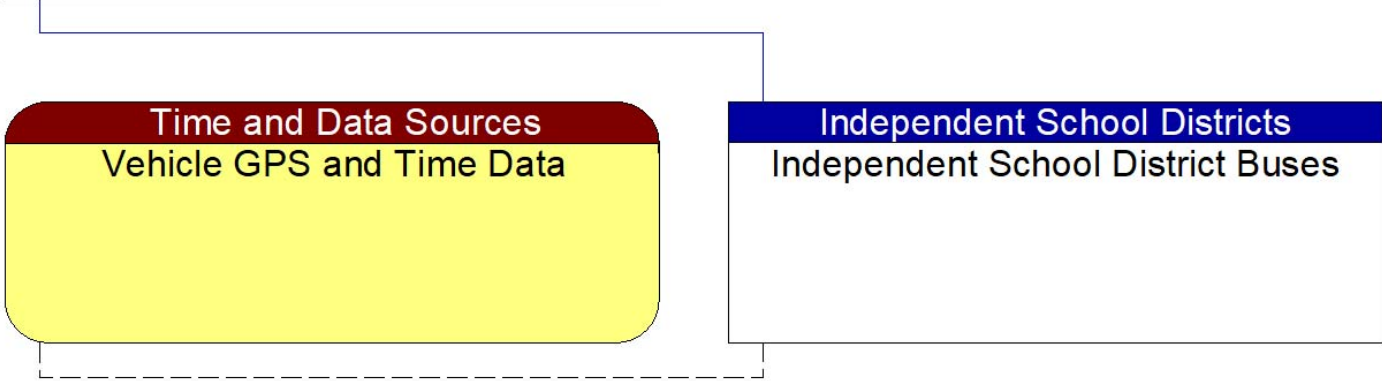

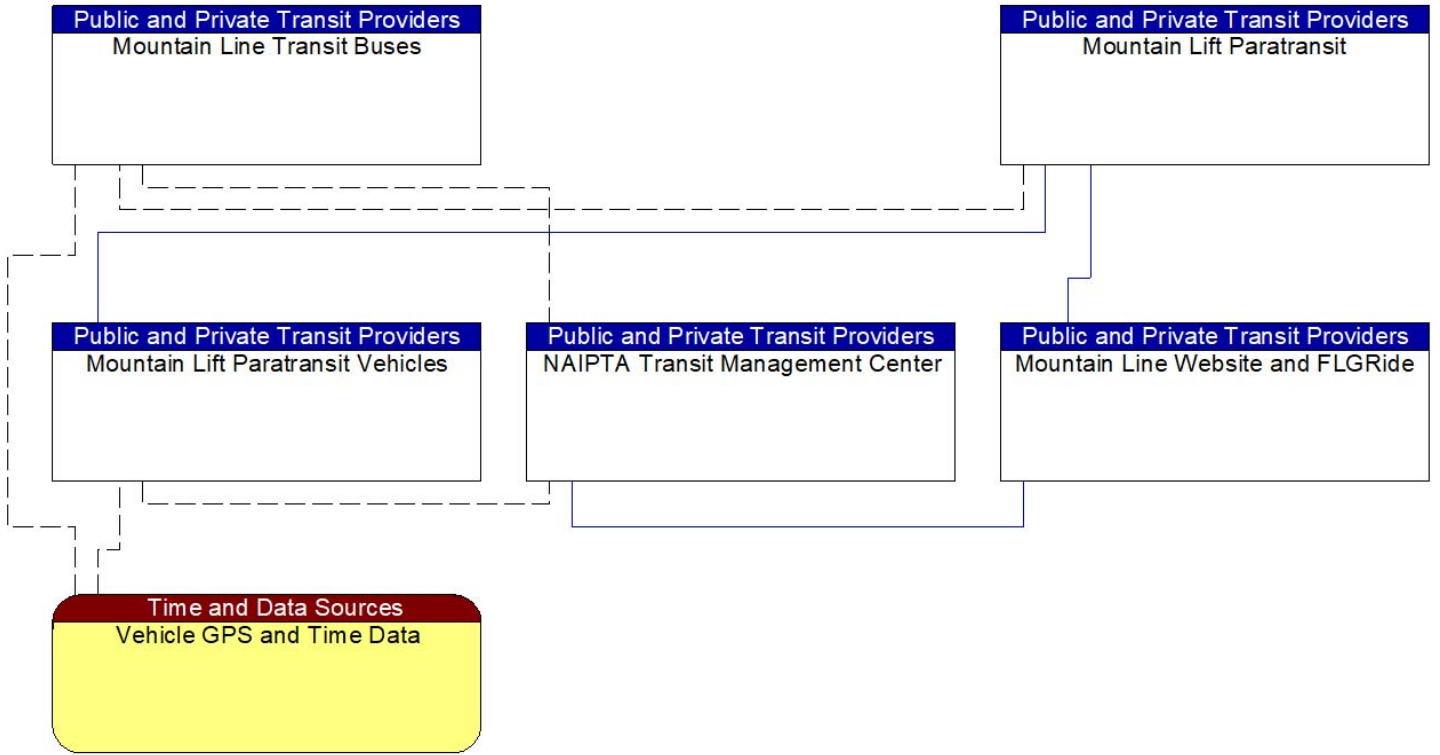

— Existing
 - - - Planned

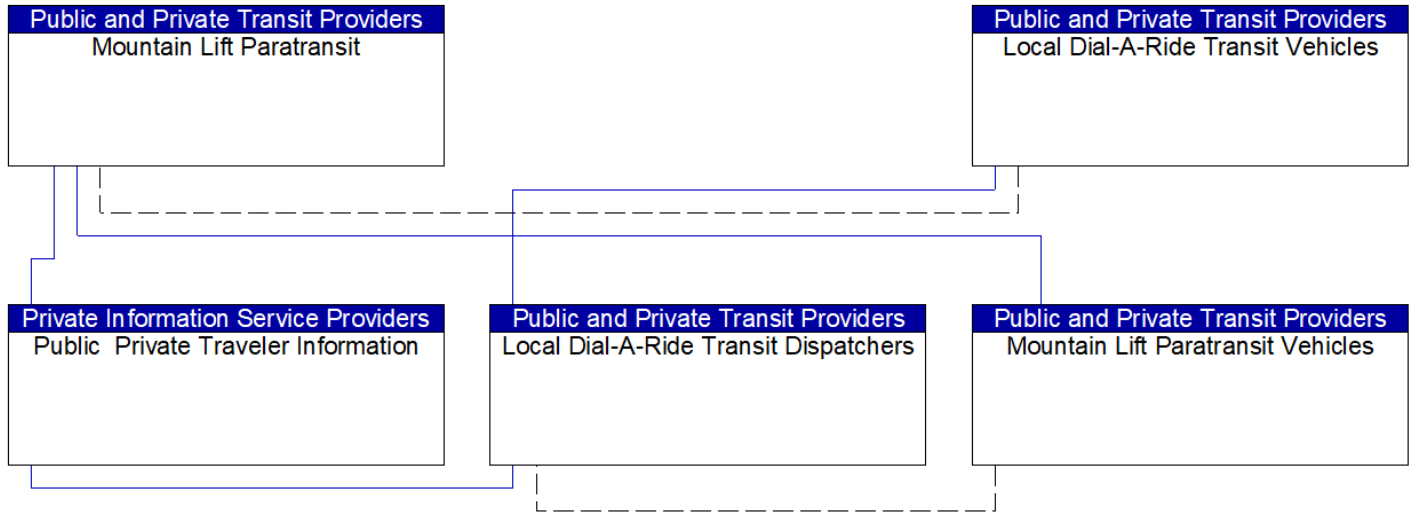

_____ Existing
 - - - - - Planned

Public and Private Transit Providers
Transit Provider Vehicles

Private Information Service Providers
Public Private Traveler Information

Public and Private Transit Providers
Transit Providers - Public and Private

———— Existing
----- Planned

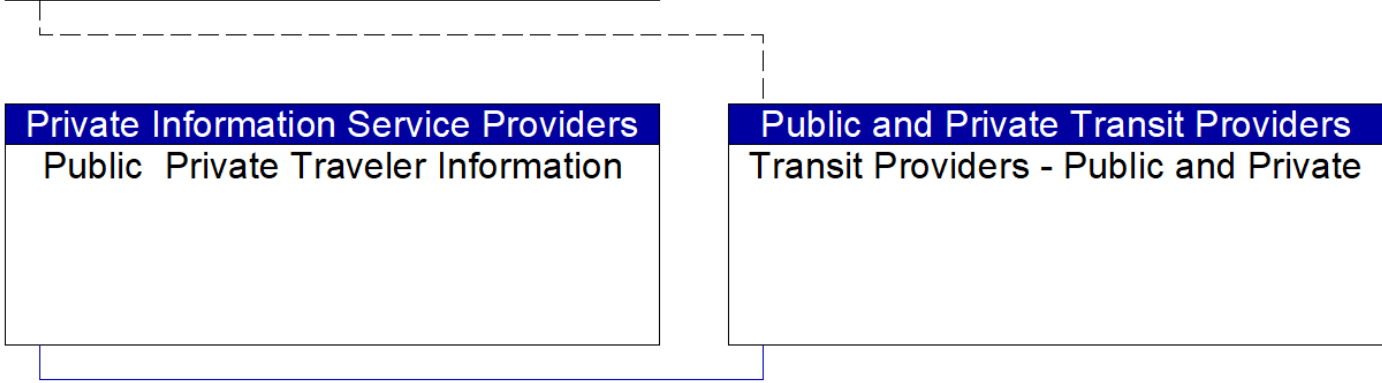

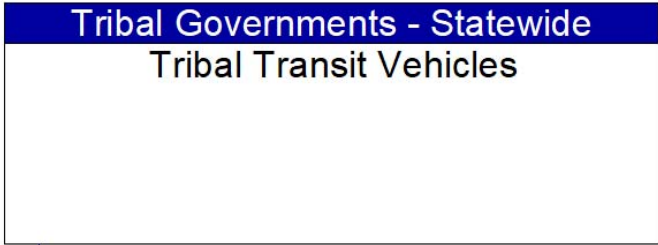
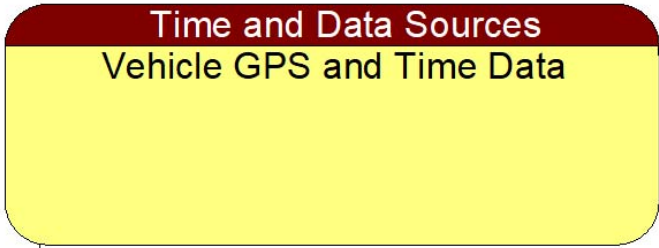

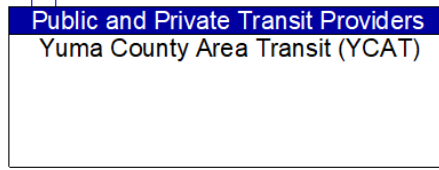
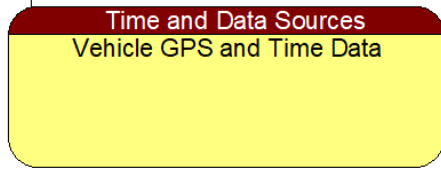
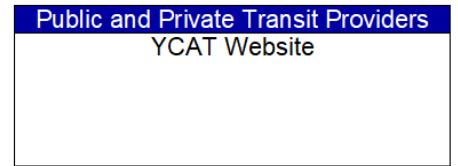
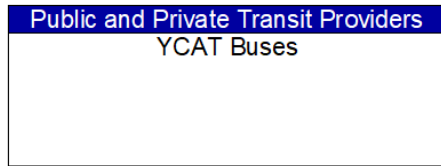

———— Existing
- - - - - Planned

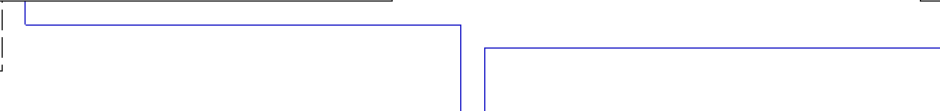

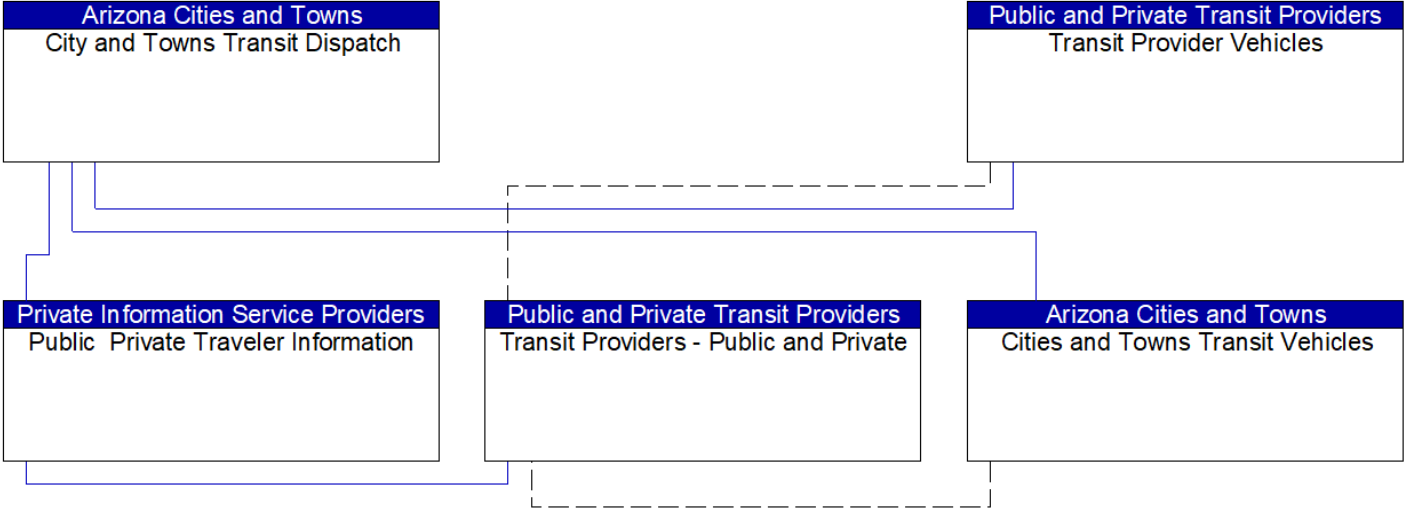

— Existing
 - - - - - Planned

Independent School Districts
Independent School District Buses

Independent School Districts
Independent School District Bus
Dispatch

Existing

Private Information Service Providers
Public Private Traveler Information

Public and Private Transit Providers
Mountain Line Transit Buses

Public and Private Transit Providers
Mountain Line Website and FLGRide

Public and Private Transit Providers
NAIPTA Transit Management Center

———— Existing
----- Planned

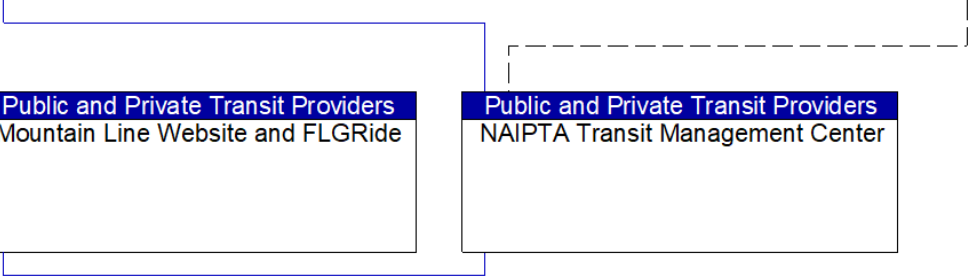

Tribal Governments - Statewide
Tribal Transit Vehicles

Tribal Governments - Statewide
Tribal Transit Centers

Existing

Private Information Service Providers
Public Private Traveler Information

Public and Private Transit Providers
YCAT Website

Public and Private Transit Providers
YCAT Buses

Public and Private Transit Providers
Yuma County Area Transit (YCAT)

Existing

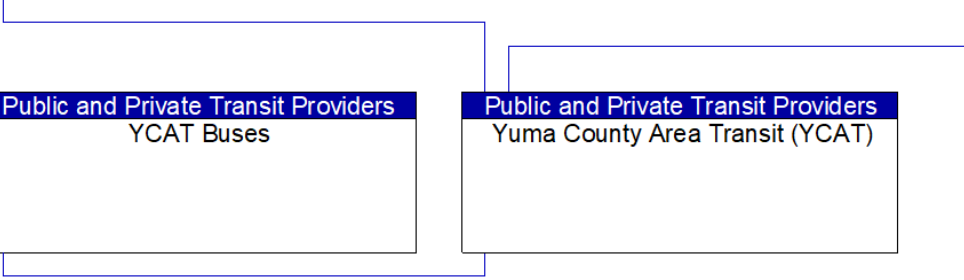

Public and Private Transit Providers
Local Dial-A-Ride Transit Vehicles

Private Information Service Providers
Public Private Traveler Information

Public and Private Transit Providers
Local Dial-A-Ride Transit Dispatchers

Existing

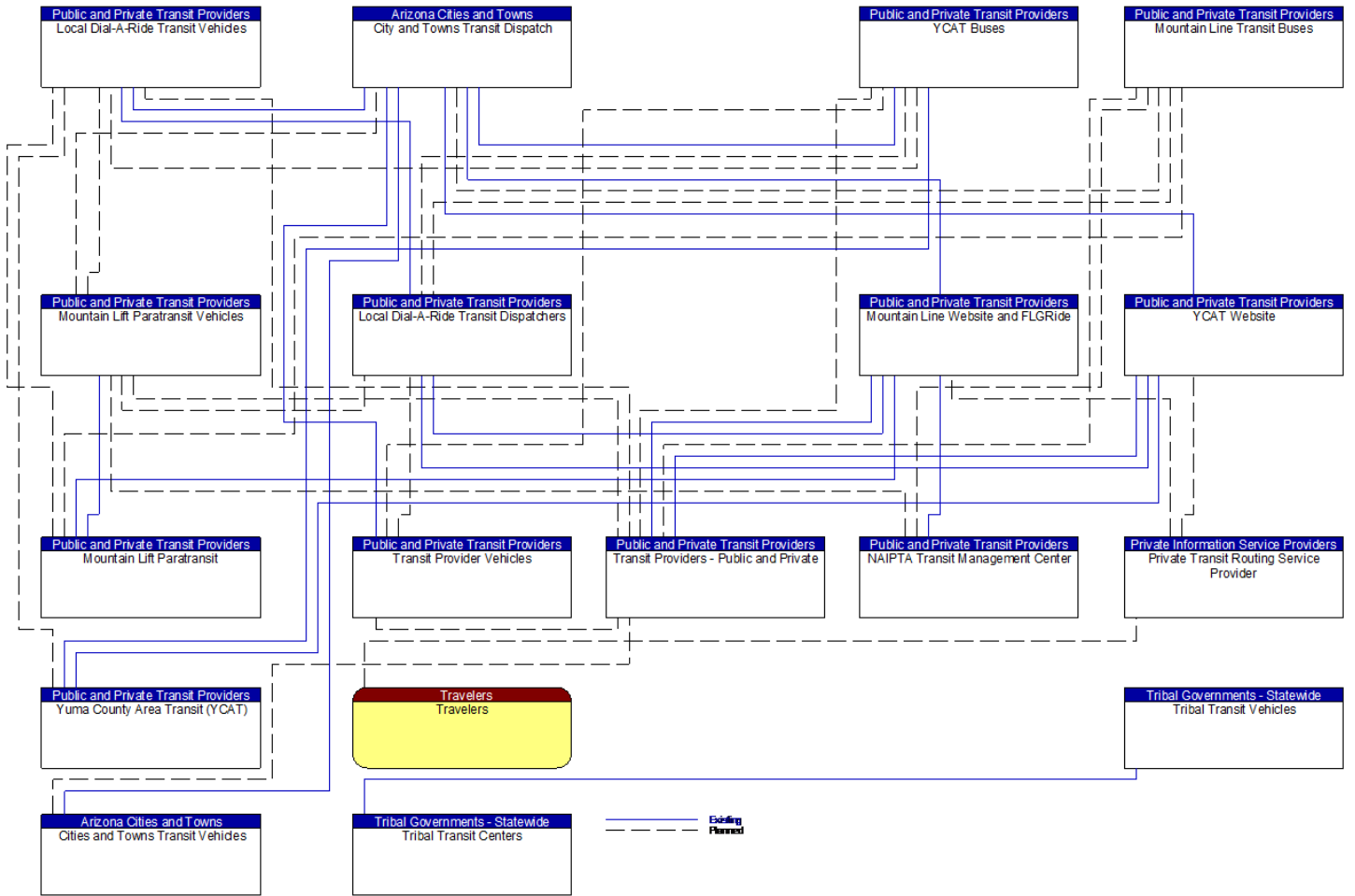

Private Information Service Providers

Public Private Traveler Information



Public and Private Transit Providers

YCAT Buses

Public and Private Transit Providers

Yuma County Area Transit (YCAT)



Existing

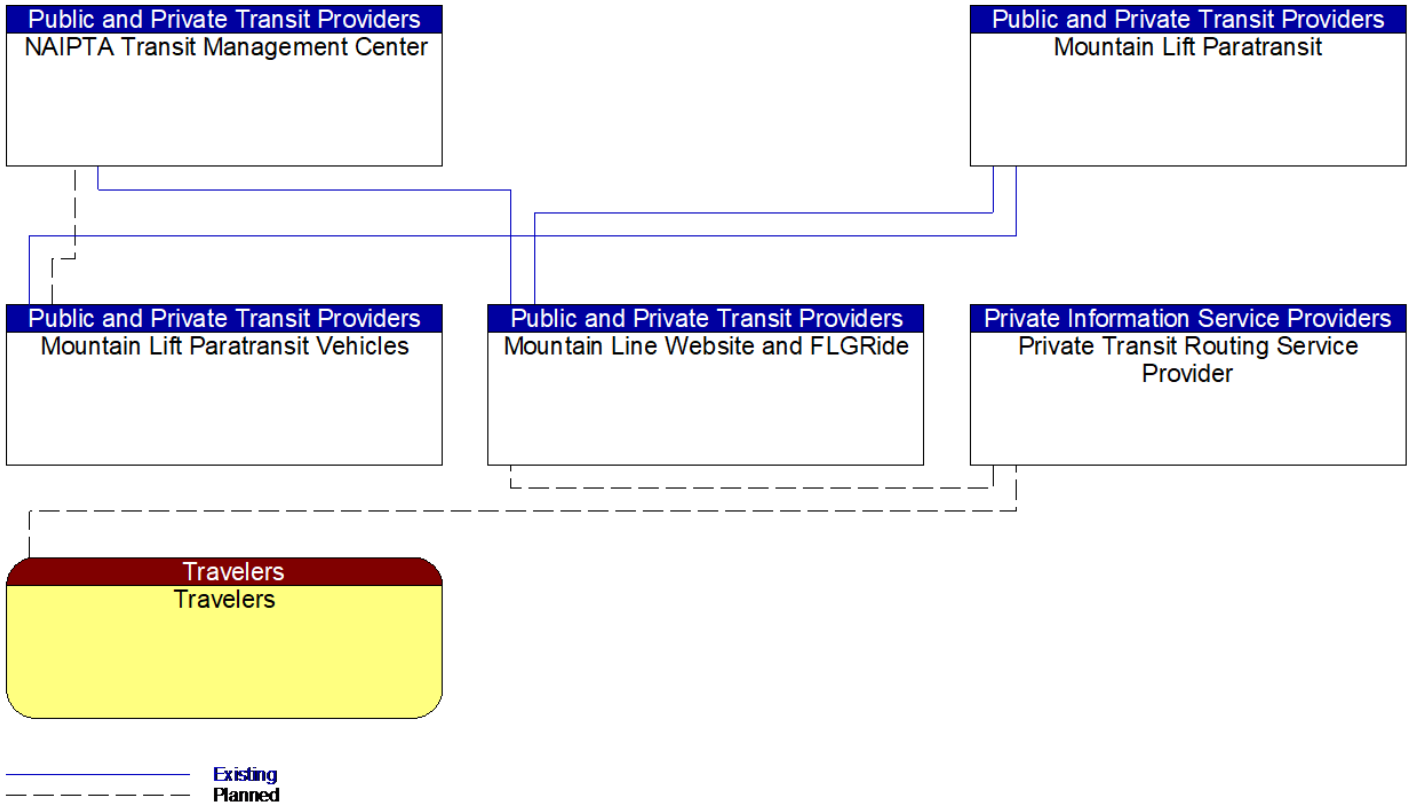

Tribal Governments - Statewide
Tribal Transit Vehicles

Tribal Governments - Statewide
Tribal Transit Centers

Existing

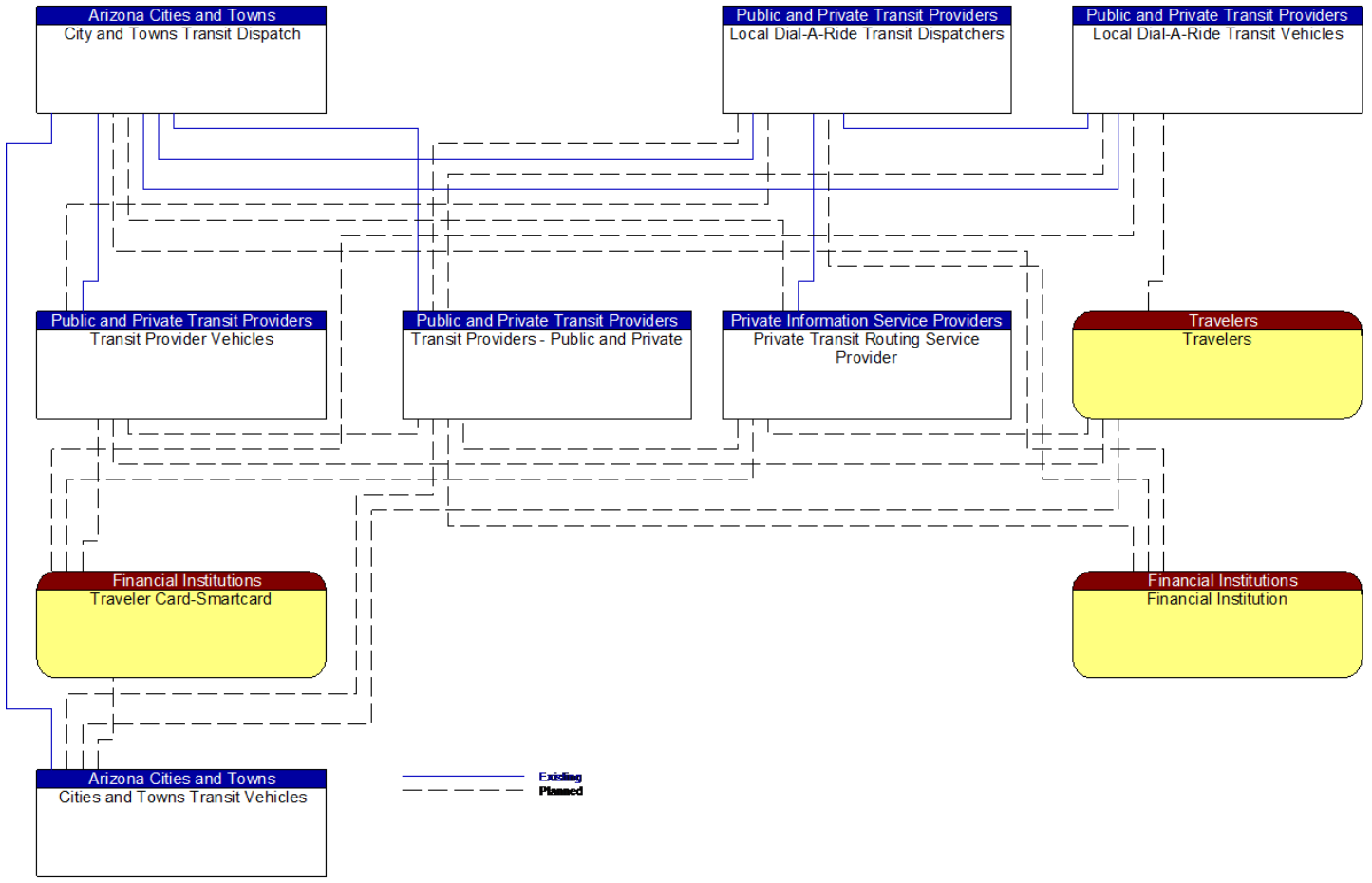

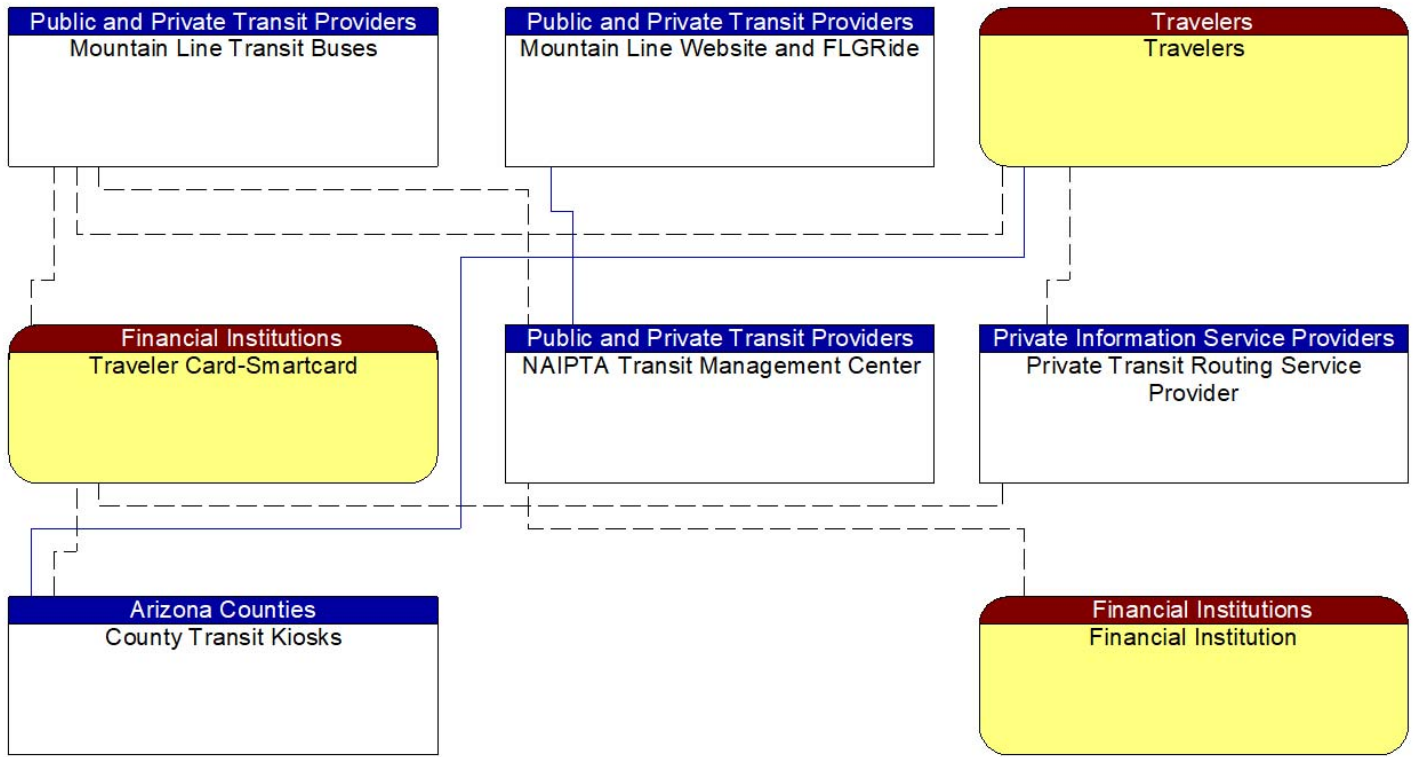

— Existing
 - - - Planned

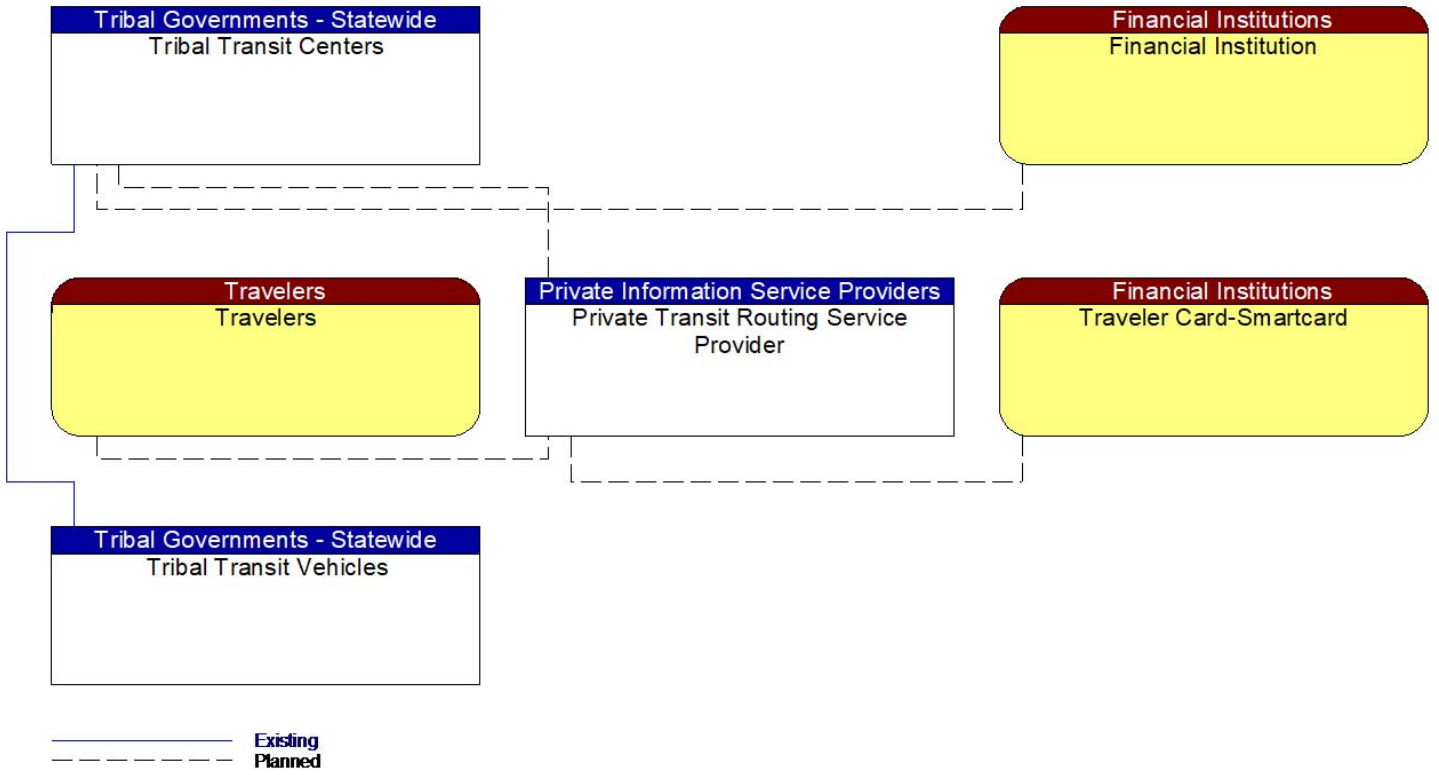

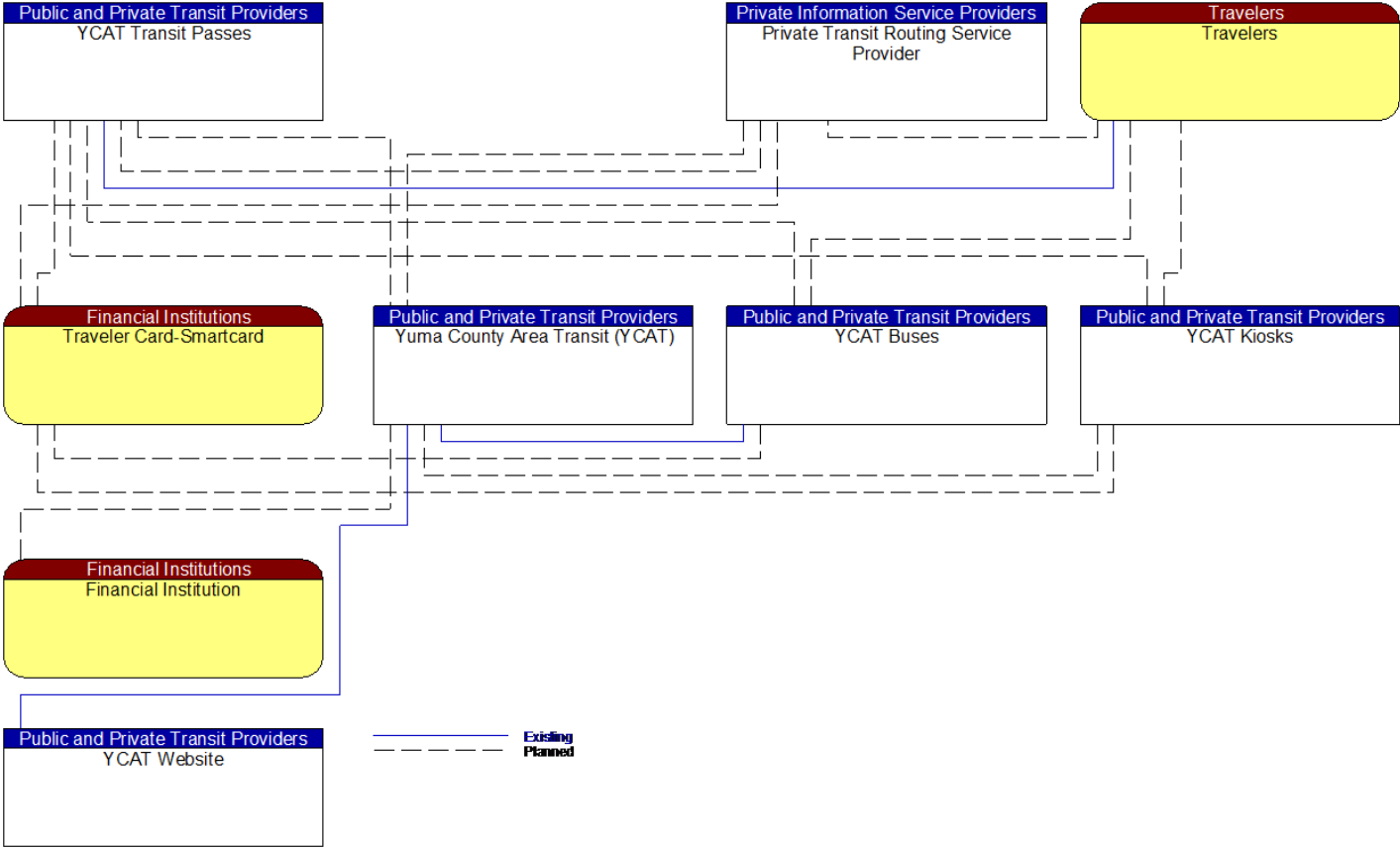

Arizona Department of Public Safety ...
DPS Central Communications Center

Arizona Cities and Towns
Cities and Towns Transit Vehicles

Arizona Cities and Towns
City and Towns Transit Dispatch

Existing

Independent School Districts
Independent School District Buses

Independent School Districts
Independent School District Bus
Dispatch

Existing

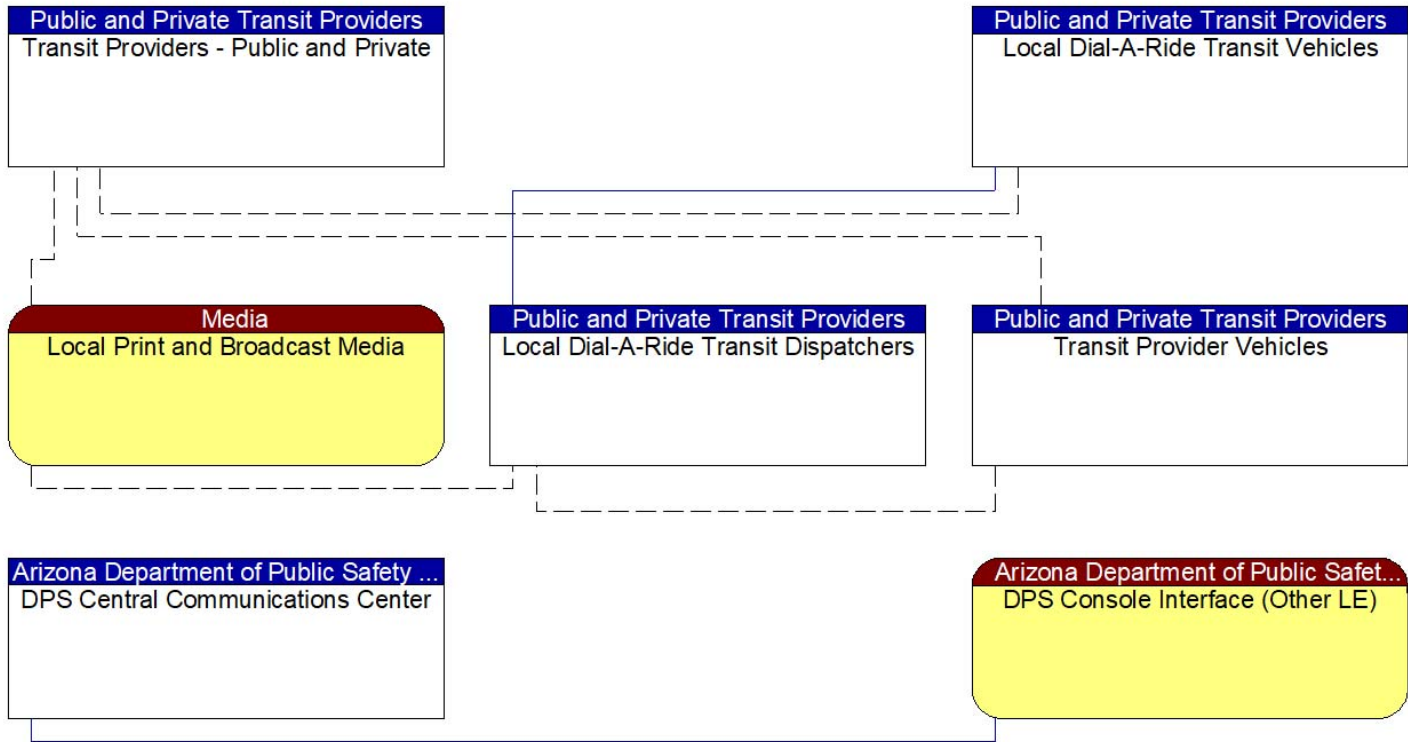

— Existing
 - - - Planned

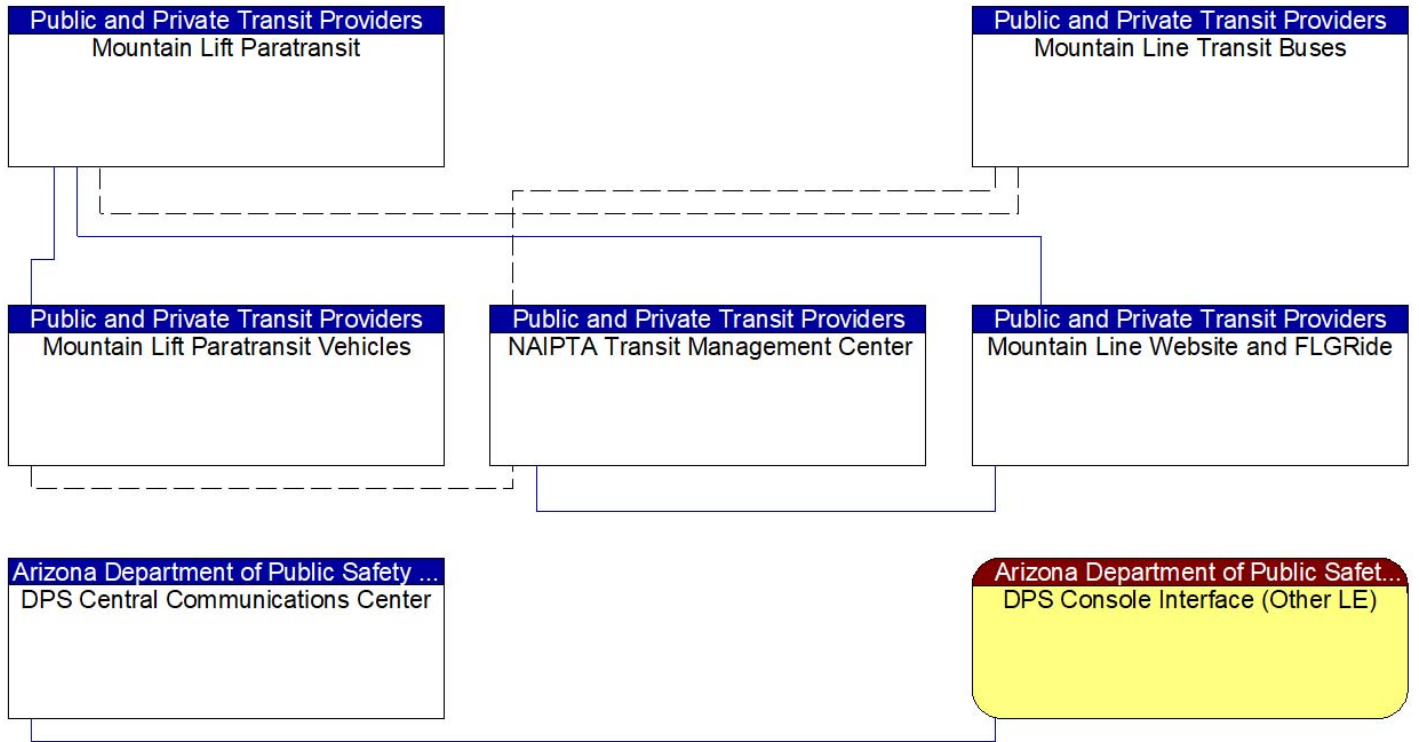

— Existing
 - - - Planned

Tribal Governments - Statewide
Tribal Transit Vehicles

Tribal Governments - Statewide
Tribal Transit Centers

Existing

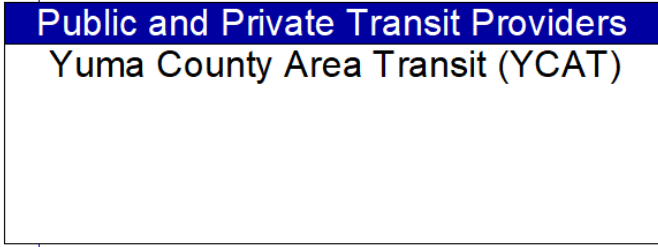
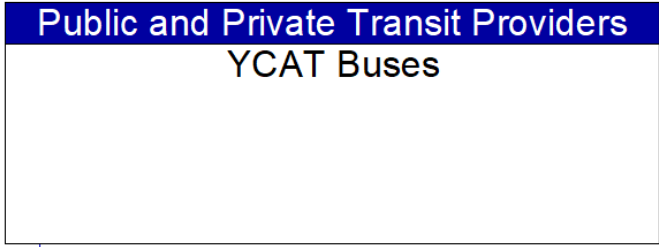
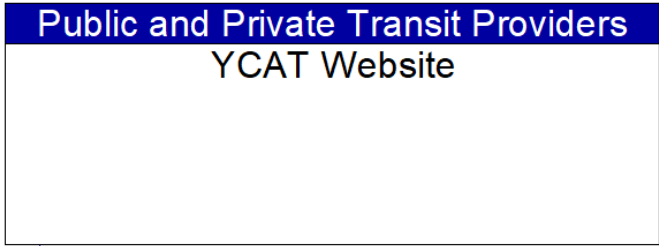

Existing

Arizona Cities and Towns
Cities and Towns Transit Vehicles

Arizona Cities and Towns
City and Towns Transit Dispatch

Existing

Independent School Districts
Independent School District Buses

Independent School Districts
Independent School District Bus
Dispatch

Existing

Public and Private Transit Providers
Transit Provider Vehicles

Public and Private Transit Providers
Transit Providers - Public and Private

----- **Planned**

Public and Private Transit Providers
Mountain Line Transit Buses

Public and Private Transit Providers
Mountain Lift Paratransit

Public and Private Transit Providers
Mountain Lift Paratransit Vehicles

Public and Private Transit Providers
NAIPTA Transit Management Center

———— Existing
- - - - - Planned

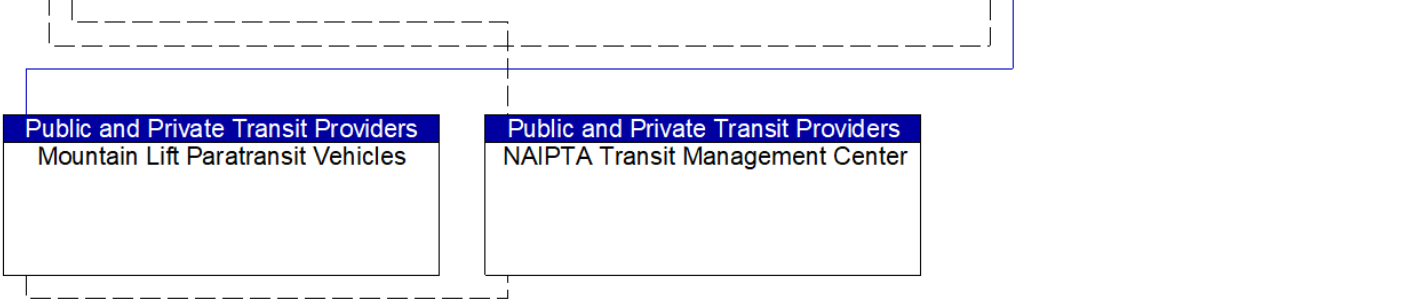

Tribal Governments - Statewide
Tribal Transit Vehicles

Tribal Governments - Statewide
Tribal Transit Centers

Existing

Public and Private Transit Providers
YCAT Buses

Public and Private Transit Providers
Yuma County Area Transit (YCAT)

Existing

Arizona Cities and Towns
Cities and Towns Transit Vehicles

Arizona Cities and Towns
City and Towns Transit Dispatch

Existing

Public and Private Transit Providers
Local Dial-A-Ride Transit Vehicles

Public and Private Transit Providers
Transit Providers - Public and Private

Public and Private Transit Providers
Transit Provider Vehicles

Public and Private Transit Providers
Local Dial-A-Ride Transit Dispatchers

Existing
Planned

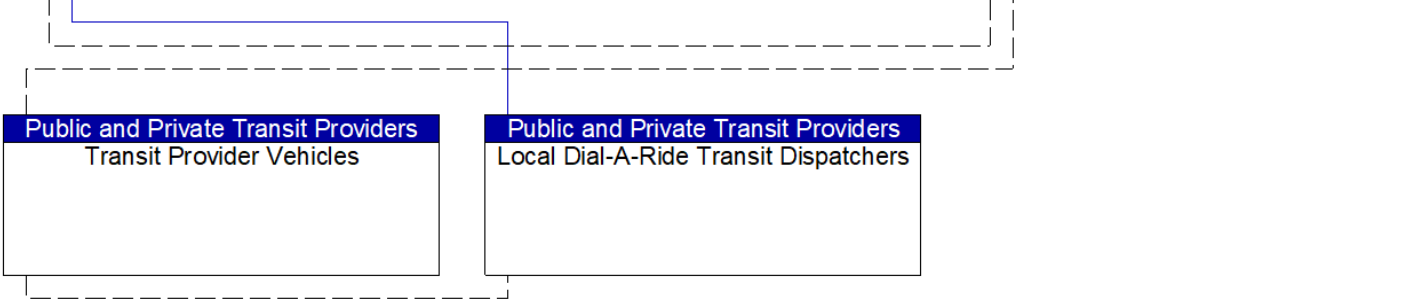

Public and Private Transit Providers
Mountain Line Transit Buses

Public and Private Transit Providers
Mountain Lift Paratransit

Public and Private Transit Providers
Mountain Lift Paratransit Vehicles

Public and Private Transit Providers
NAIPTA Transit Management Center

———— Existing
----- Planned

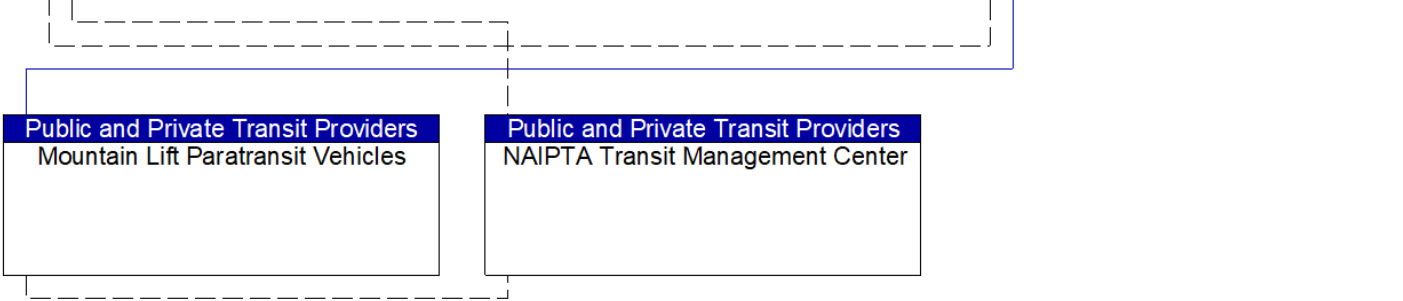

Tribal Governments - Statewide
Tribal Transit Vehicles

Tribal Governments - Statewide
Tribal Transit Centers

Existing

Public and Private Transit Providers
YCAT Buses

Public and Private Transit Providers
Yuma County Area Transit (YCAT)

Existing

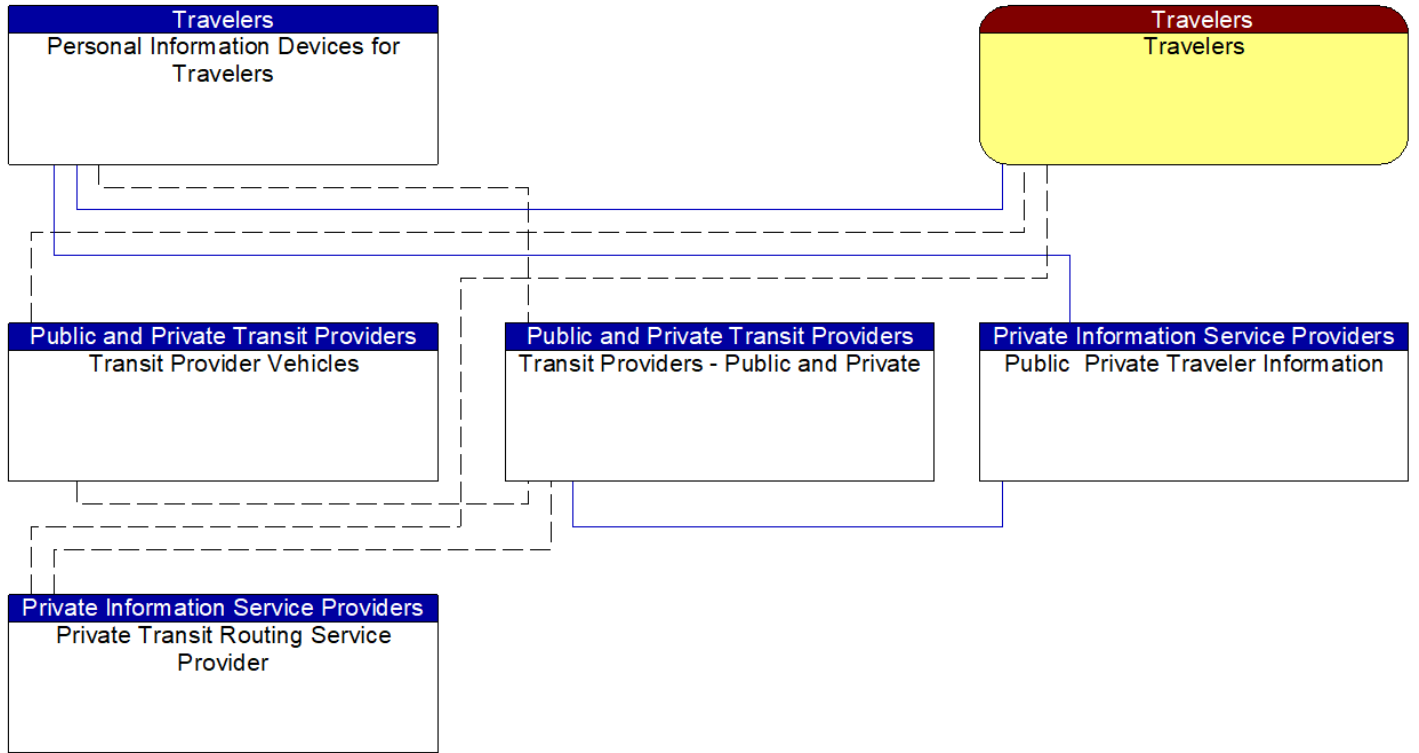

— Existing
 - - - Planned

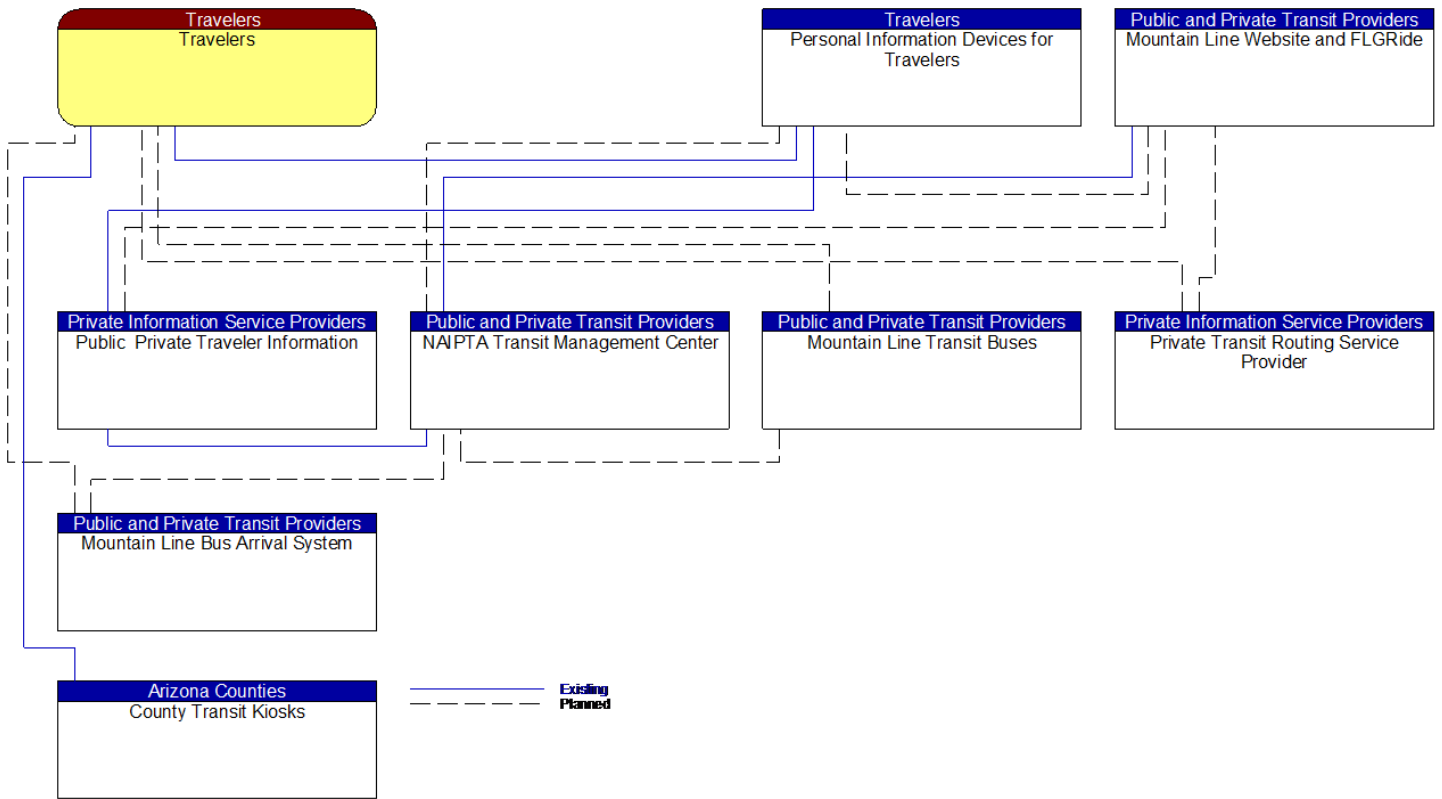

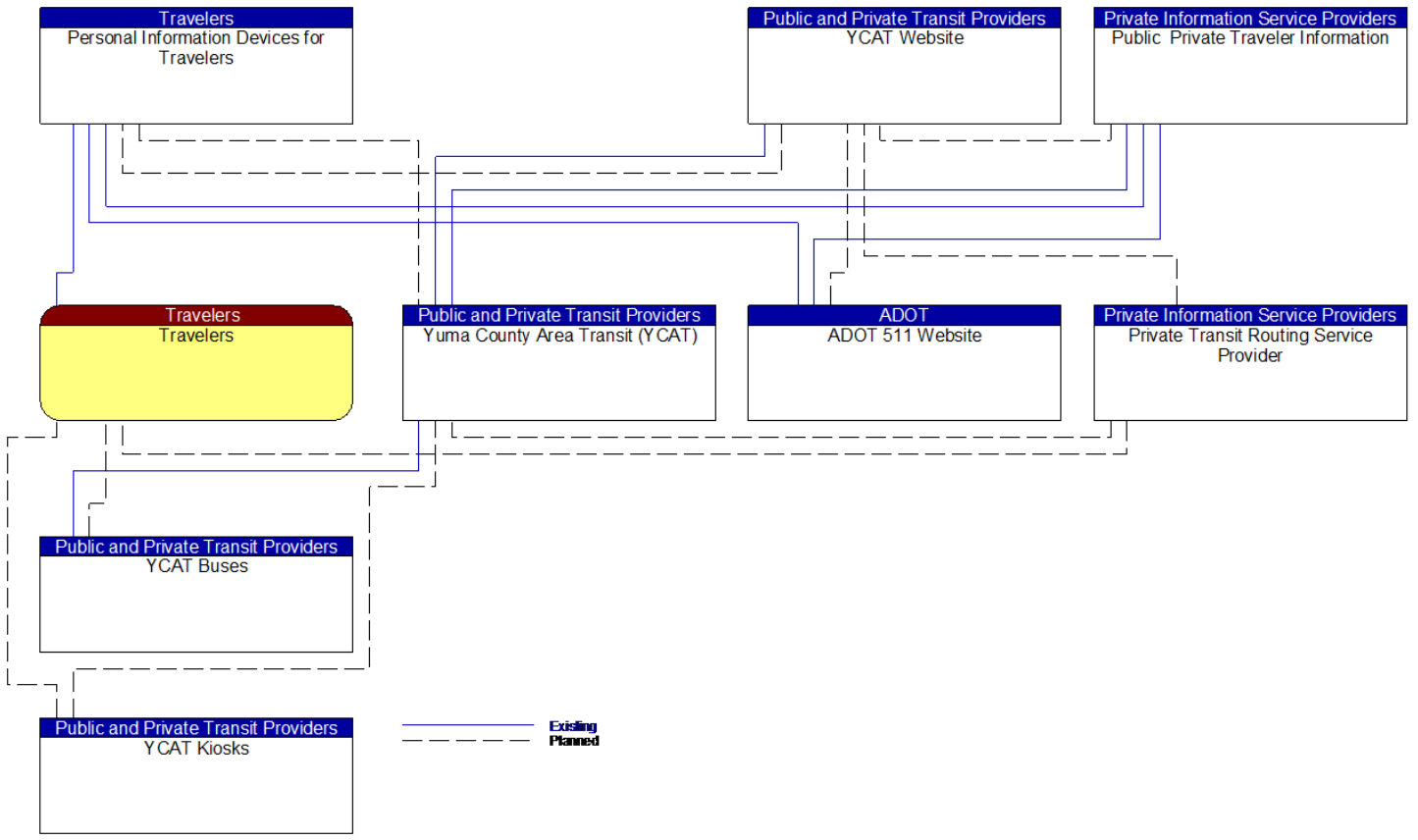

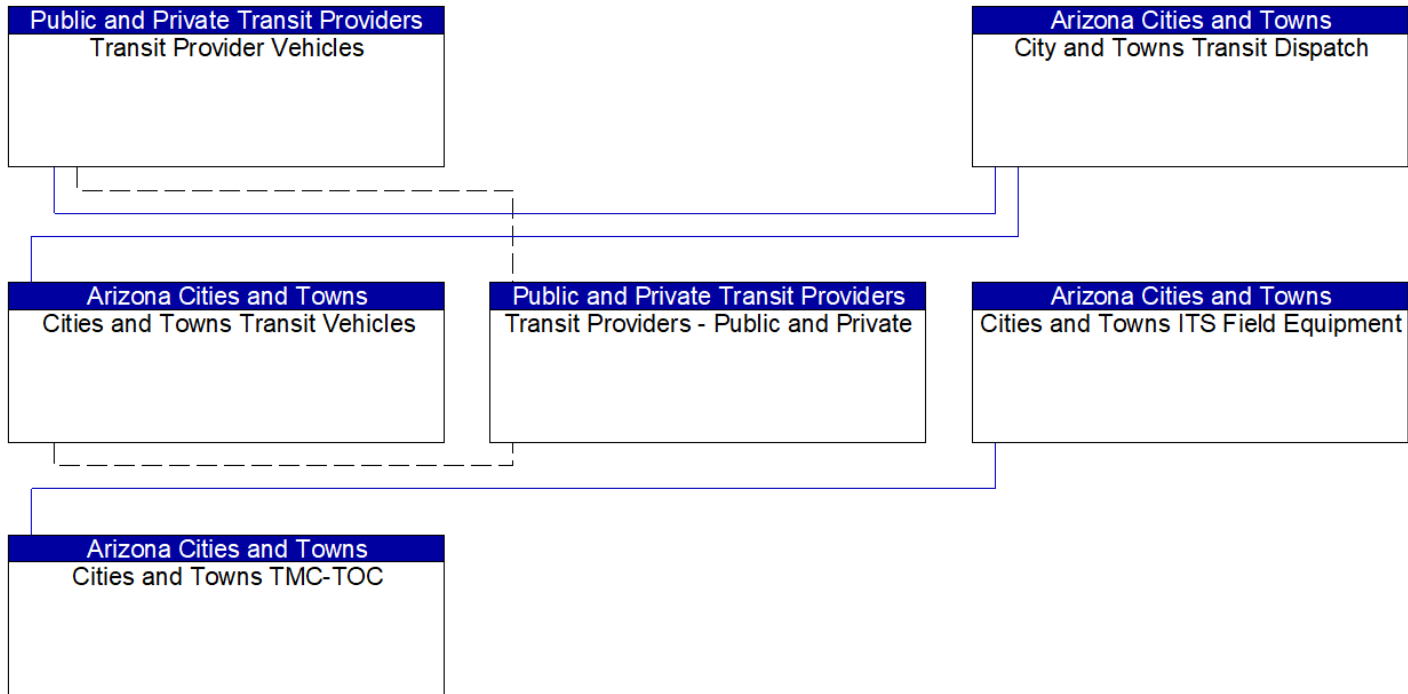

— Existing
 - - - Planned

Public and Private Transit Providers
NAIPTA Transit Management Center

Public and Private Transit Providers
NAIPTA ITS Field Equipment

Public and Private Transit Providers
Mountain Line Transit Buses

----- **Planned**

Public and Private Transit Providers
YCAT Buses

Public and Private Transit Providers
Yuma County Area Transit (YCAT)

Existing

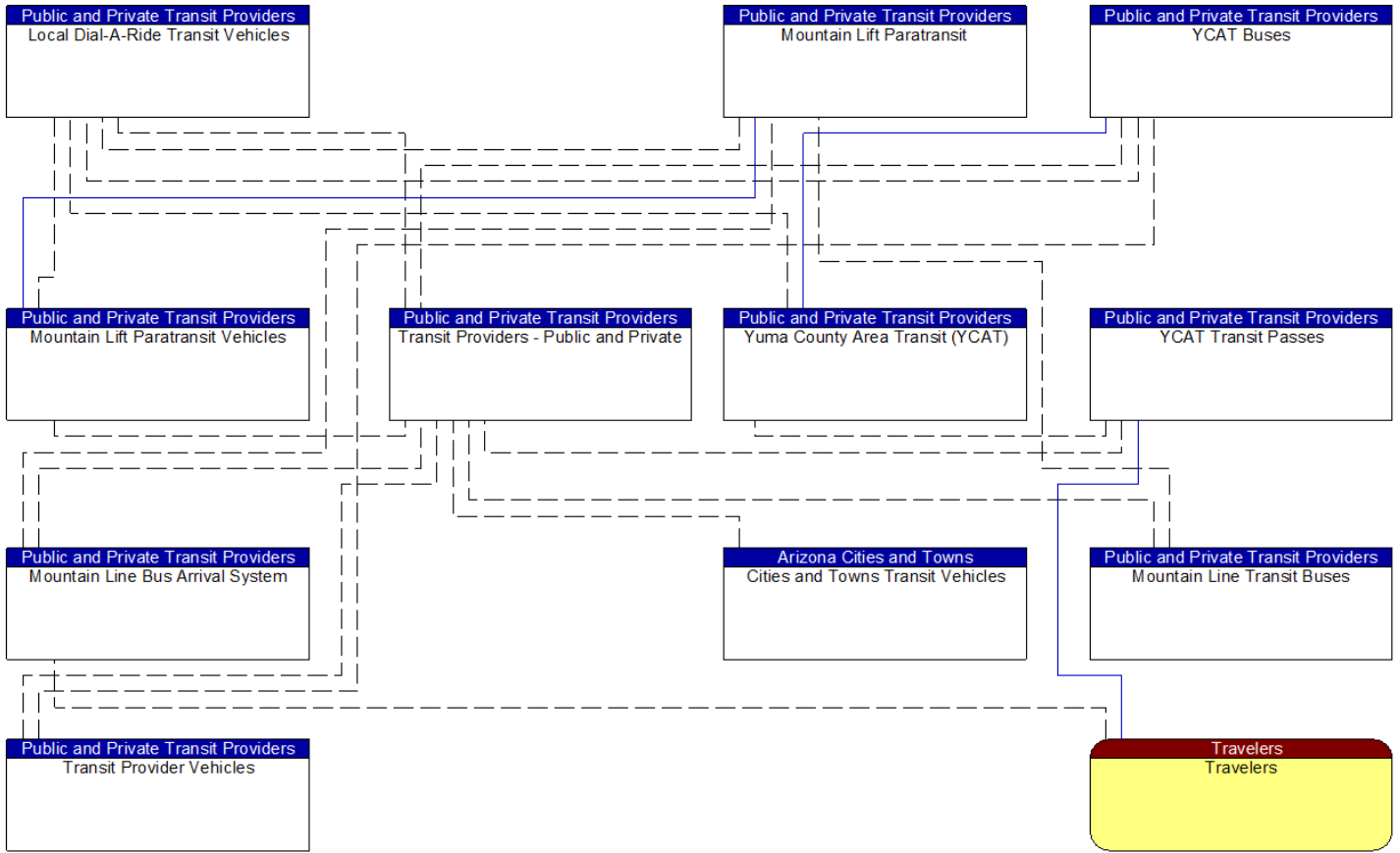

— Existing
 - - - Planned

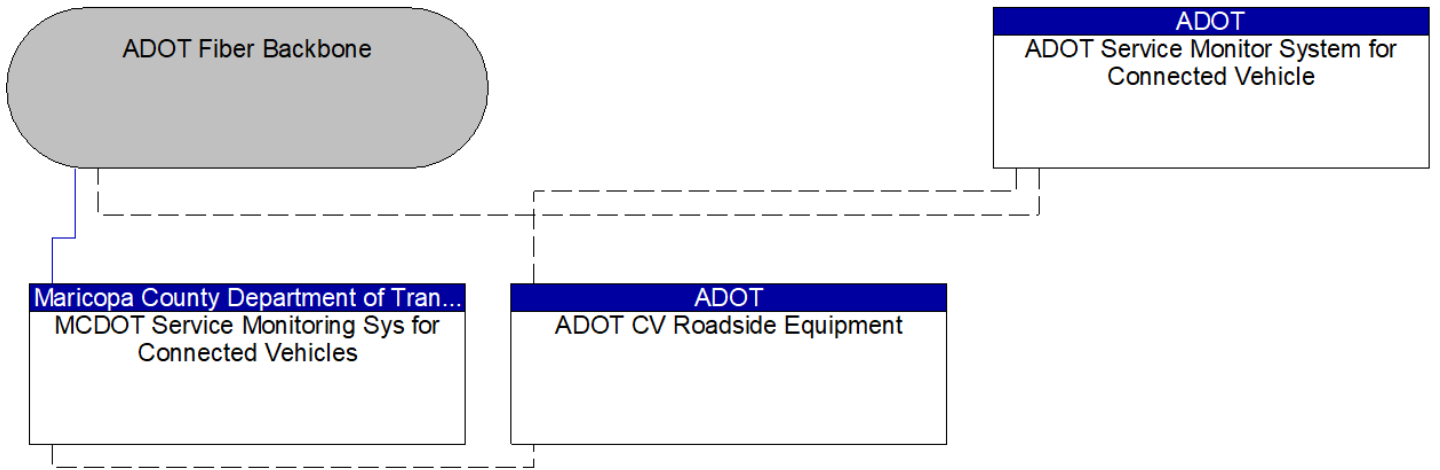

——— Existing
 - - - - - Planned

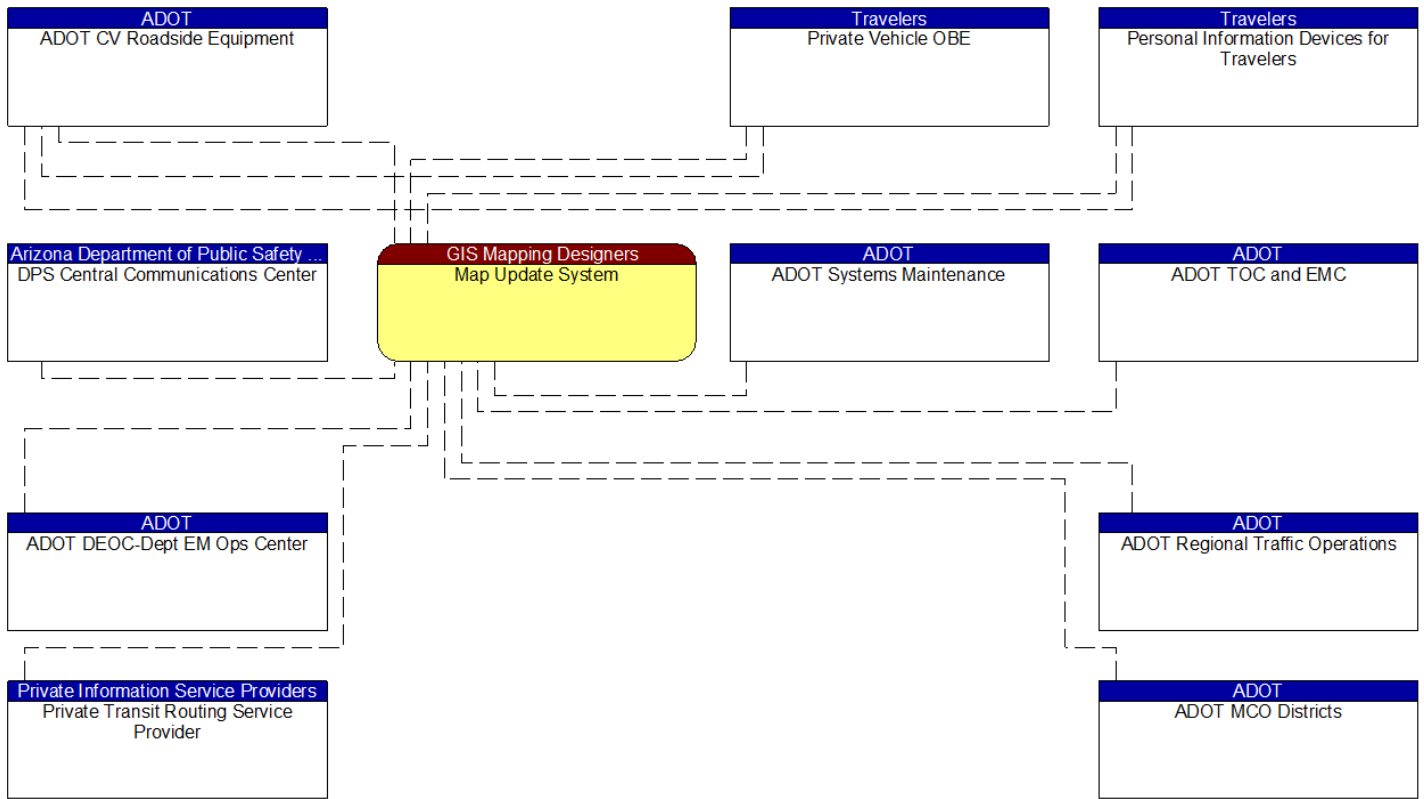

----- Planned

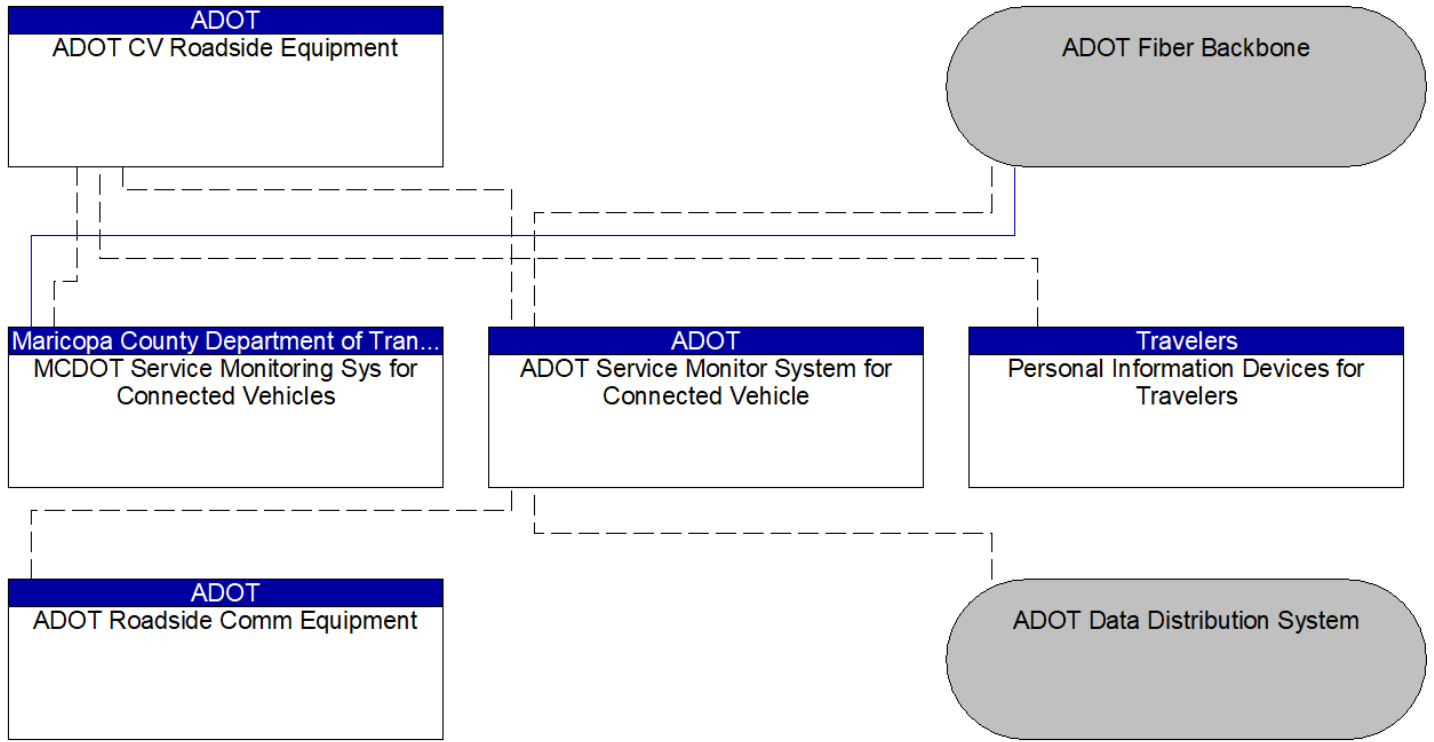

— Existing
 - - - Planned

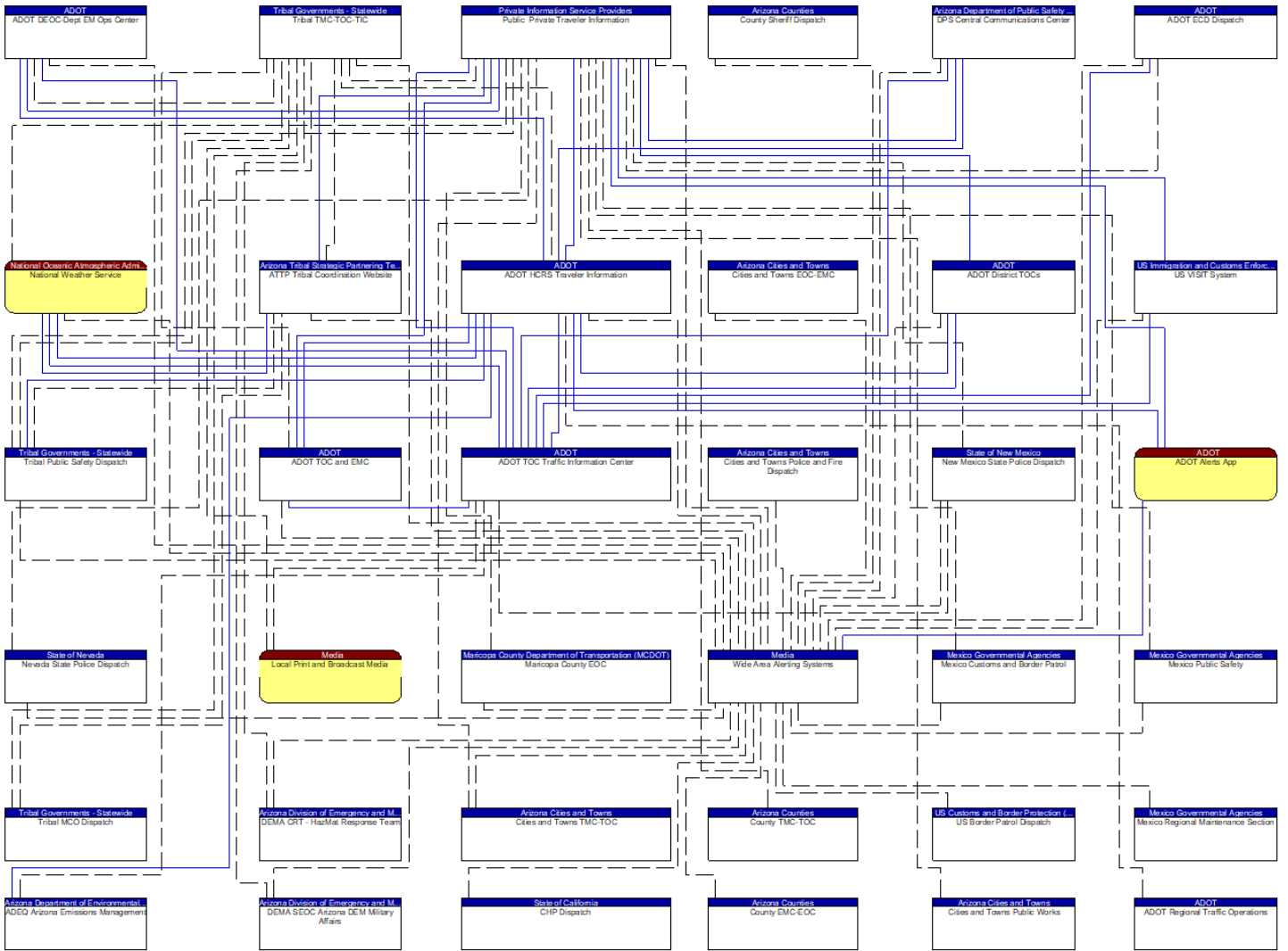

——— Primary
 Backup

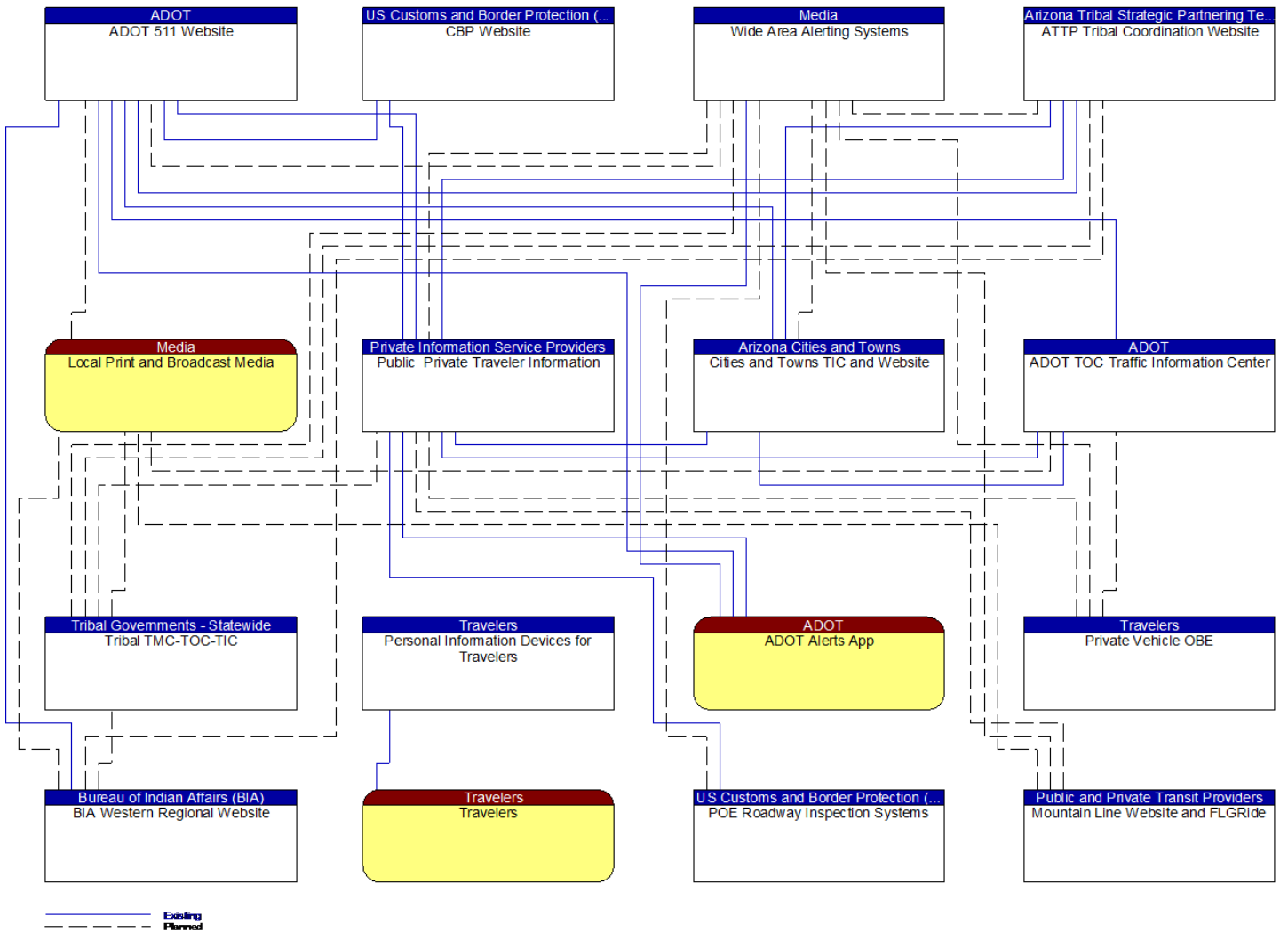

ADOT
ADOT 511 Website

US Customs and Border Protection (...)
CBP Website

Media
Wide Area Alerting Systems

Arizona Tribal Strategic Partnering Te...
ATTP Tribal Coordination Website

Media
Local Print and Broadcast Media

Private Information Service Providers
Public Private Traveler Information

Arizona Cities and Towns
Cities and Towns TIC and Website

ADOT
ADOT TOC Traffic Information Center

Tribal Governments - Statewide
Tribal TMC-TOC-TIC

Travelers
Personal Information Devices for
Travelers

ADOT
ADOT Alerts App

Travelers
Private Vehicle OBE

Bureau of Indian Affairs (BIA)
BIA Western Regional Website

Travelers
Travelers

US Customs and Border Protection (...)
POE Roadway Inspection Systems

Public and Private Transit Providers
Mountain Line Website and FLGRide

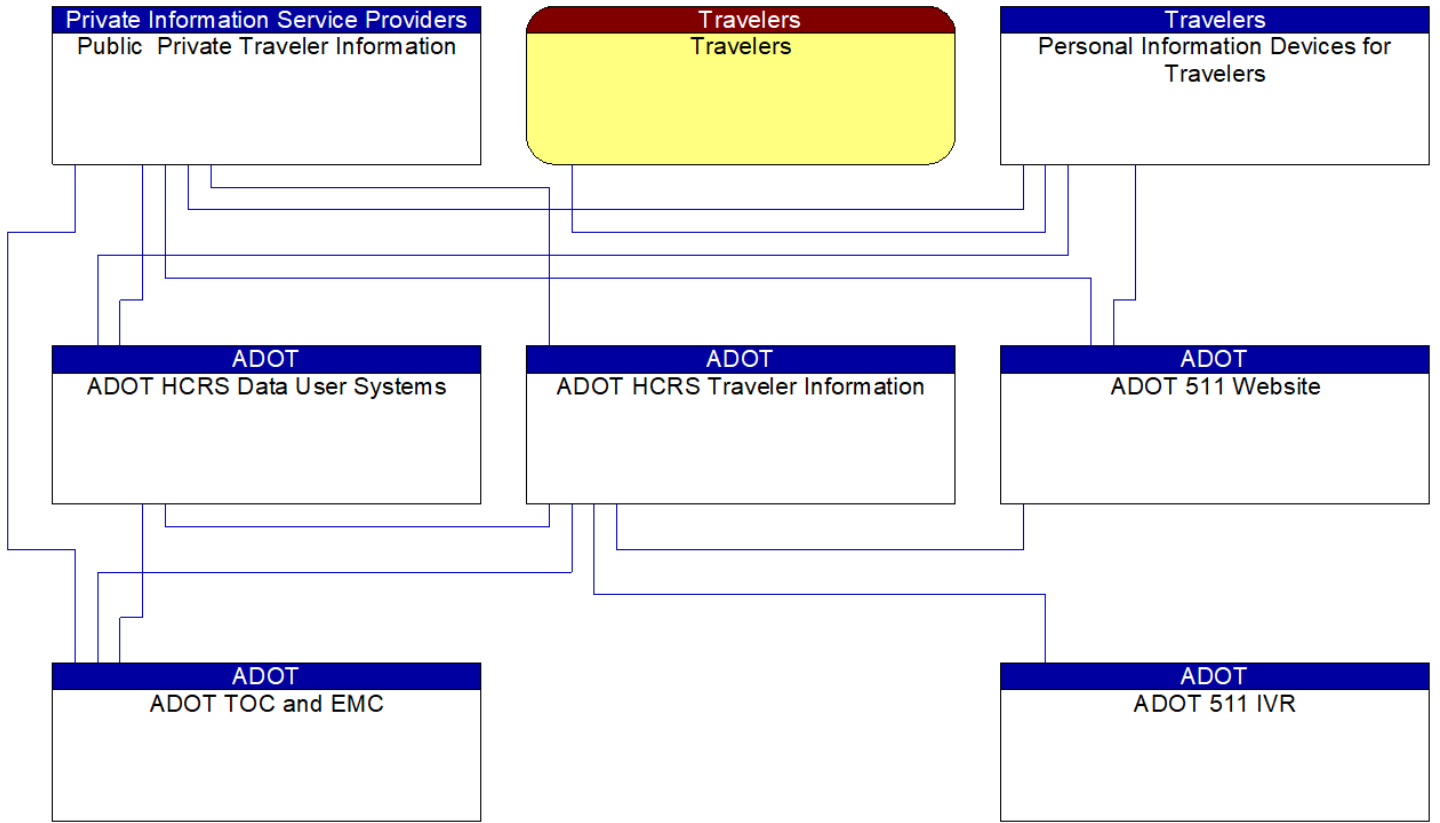

Existing

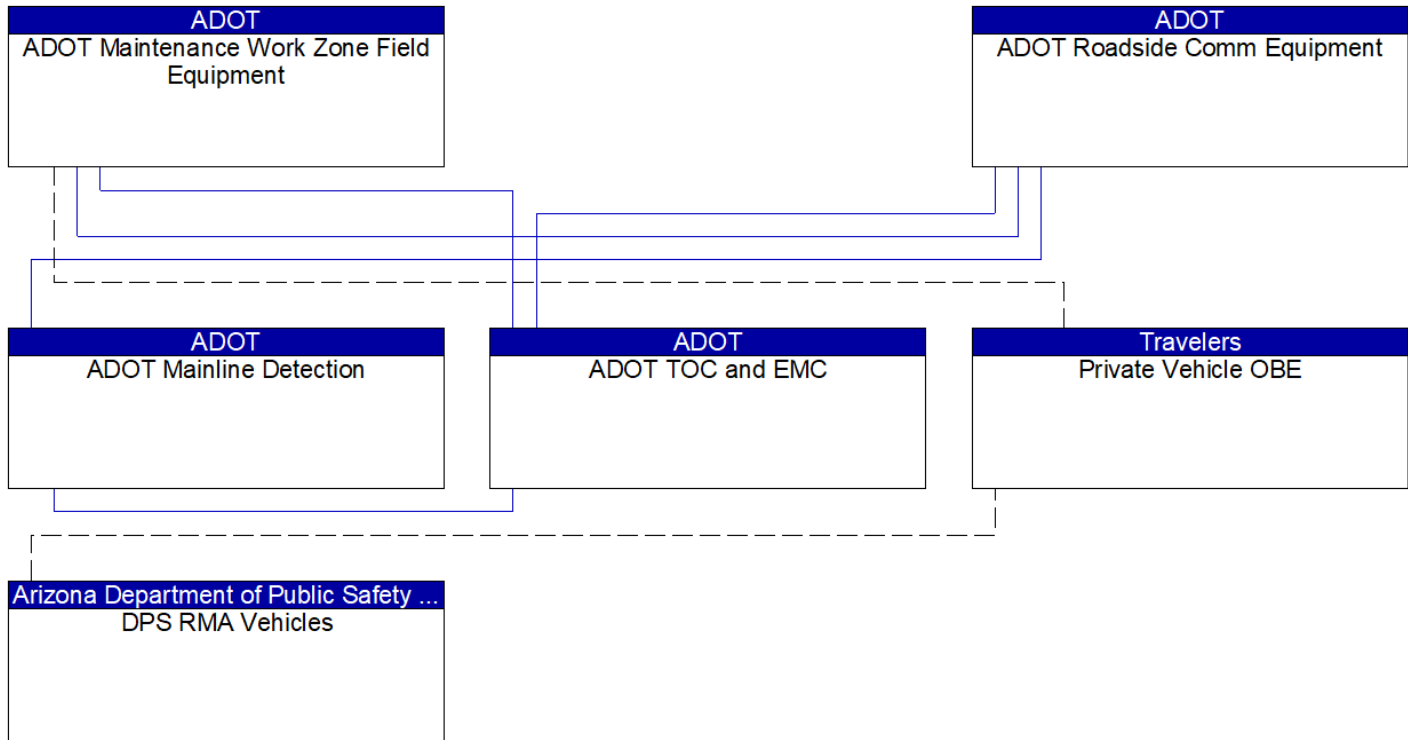

— Existing
 - - - Planned

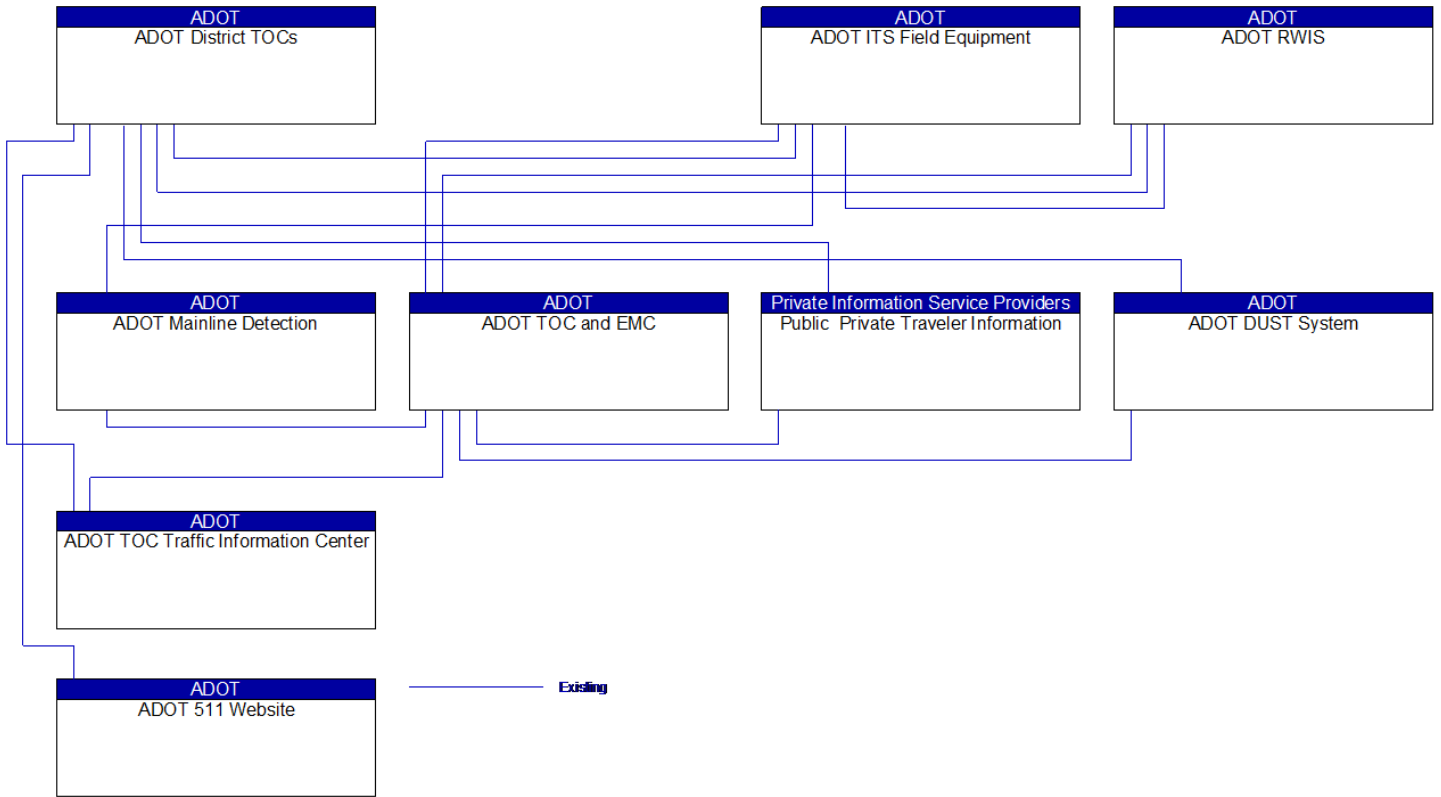

Arizona Cities and Towns
Cities and Towns ITS Field Equipment

Arizona Cities and Towns
Cities and Towns Weather Flood Alerts

Private Information Service Providers
Public Private Traveler Information

Arizona Cities and Towns
Cities and Towns TMC-TOC

Arizona Cities and Towns
Cities and Towns TIC and Website

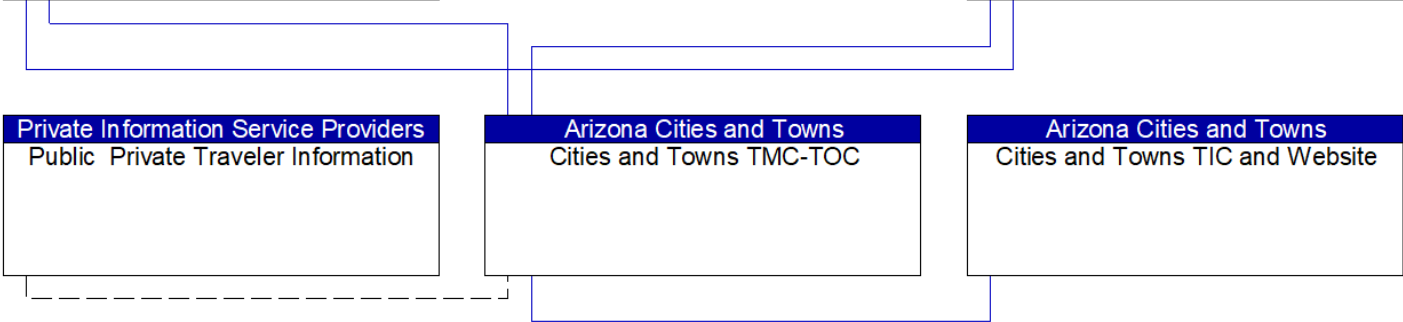

———— Existing
----- Planned

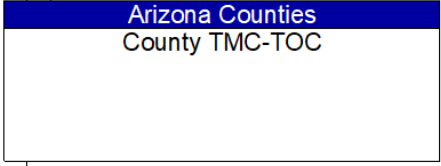
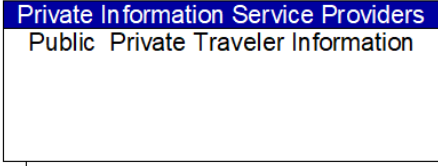
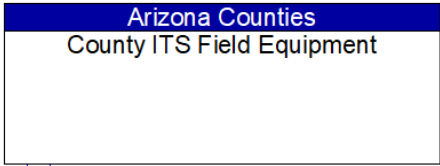
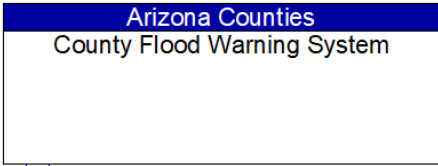

Existing
Planned

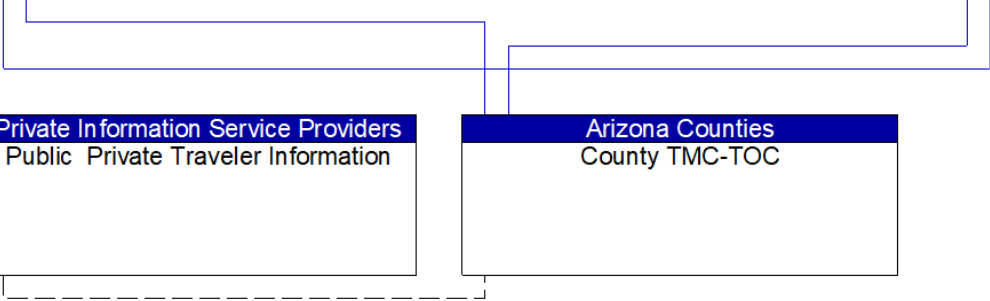

Private Information Service Providers

Public Private Traveler Information

Tribal Governments - Statewide

Tribal ITS Field Equipment

Tribal Governments - Statewide

Tribal TMC-TOC-TIC

----- **Planned**

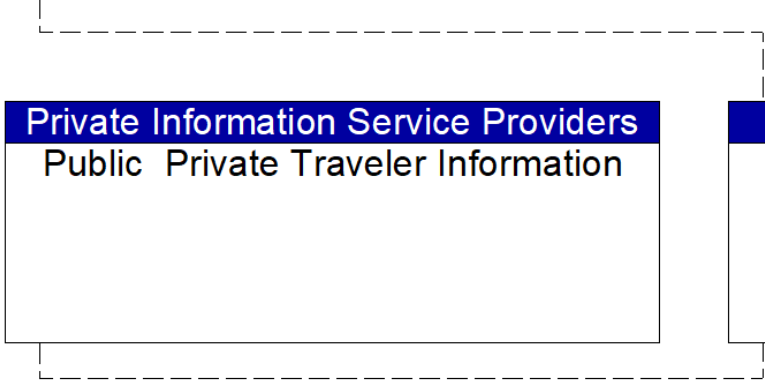
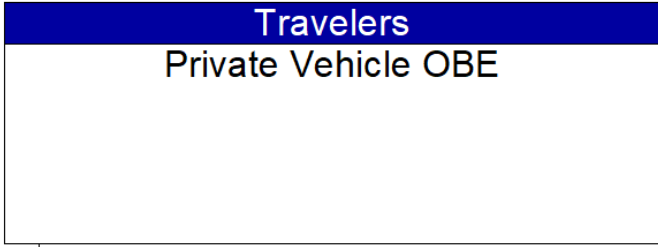
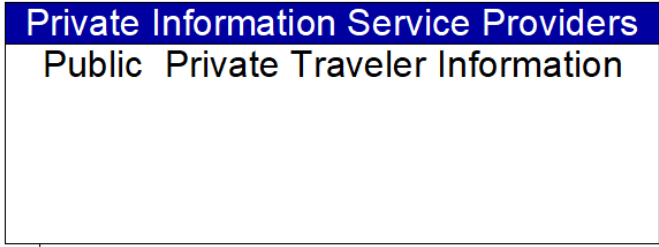
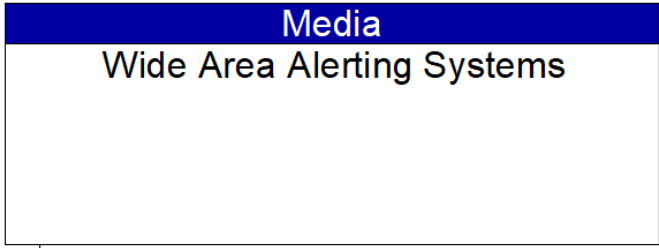

----- **Planned**

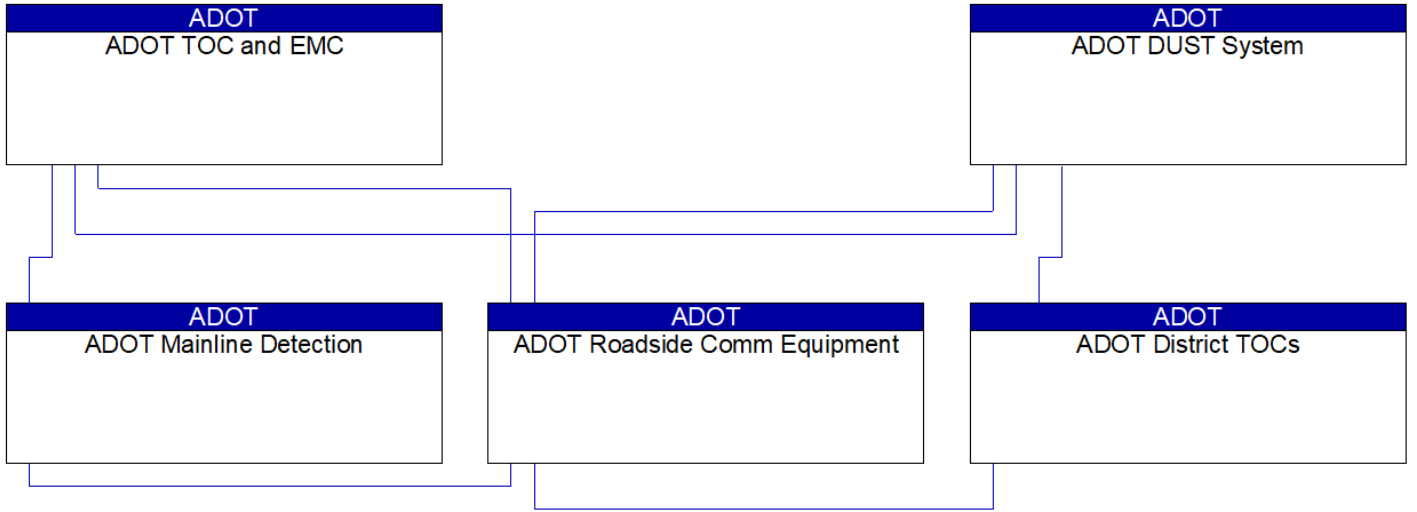

———— Existing

Arizona Cities and Towns
Cities and Towns TMC-TOC

Arizona Cities and Towns
Cities and Towns Weather Flood Alerts

Arizona Cities and Towns
Cities and Towns ITS Field Equipment

Existing

Tribal Governments - Statewide
Tribal TMC-TOC-TIC

Tribal Governments - Statewide
Tribal ITS Field Equipment

----- **Planned**

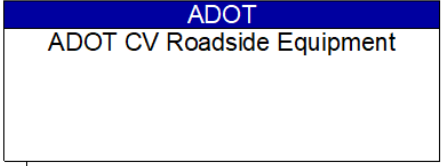
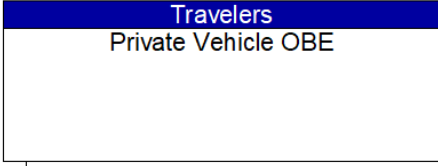
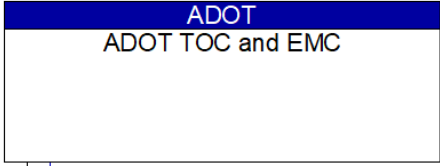
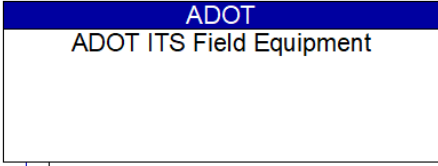

———— Existing
- - - - - Planned

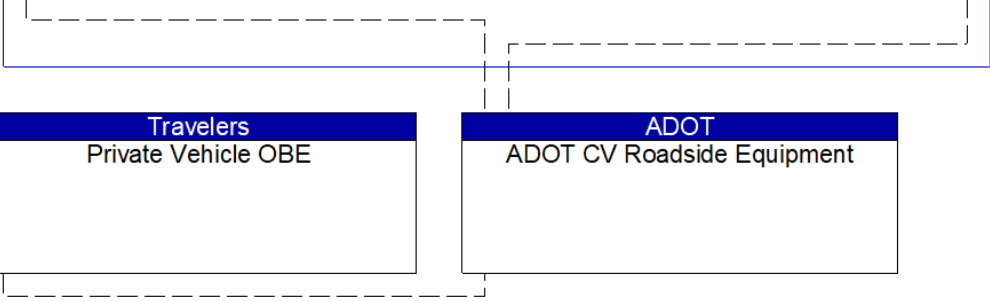

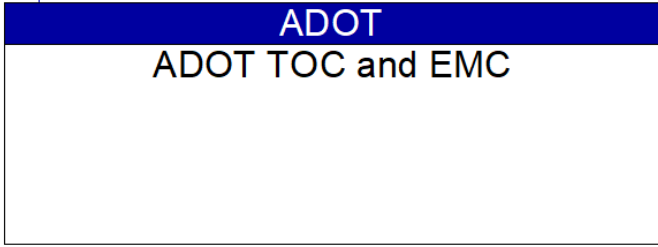
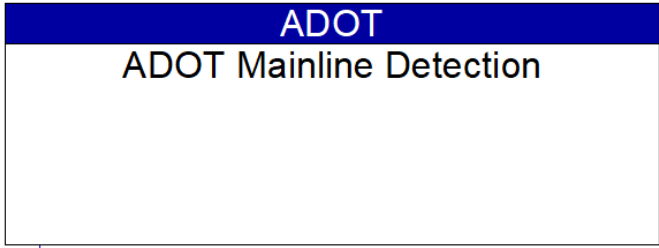

Existing

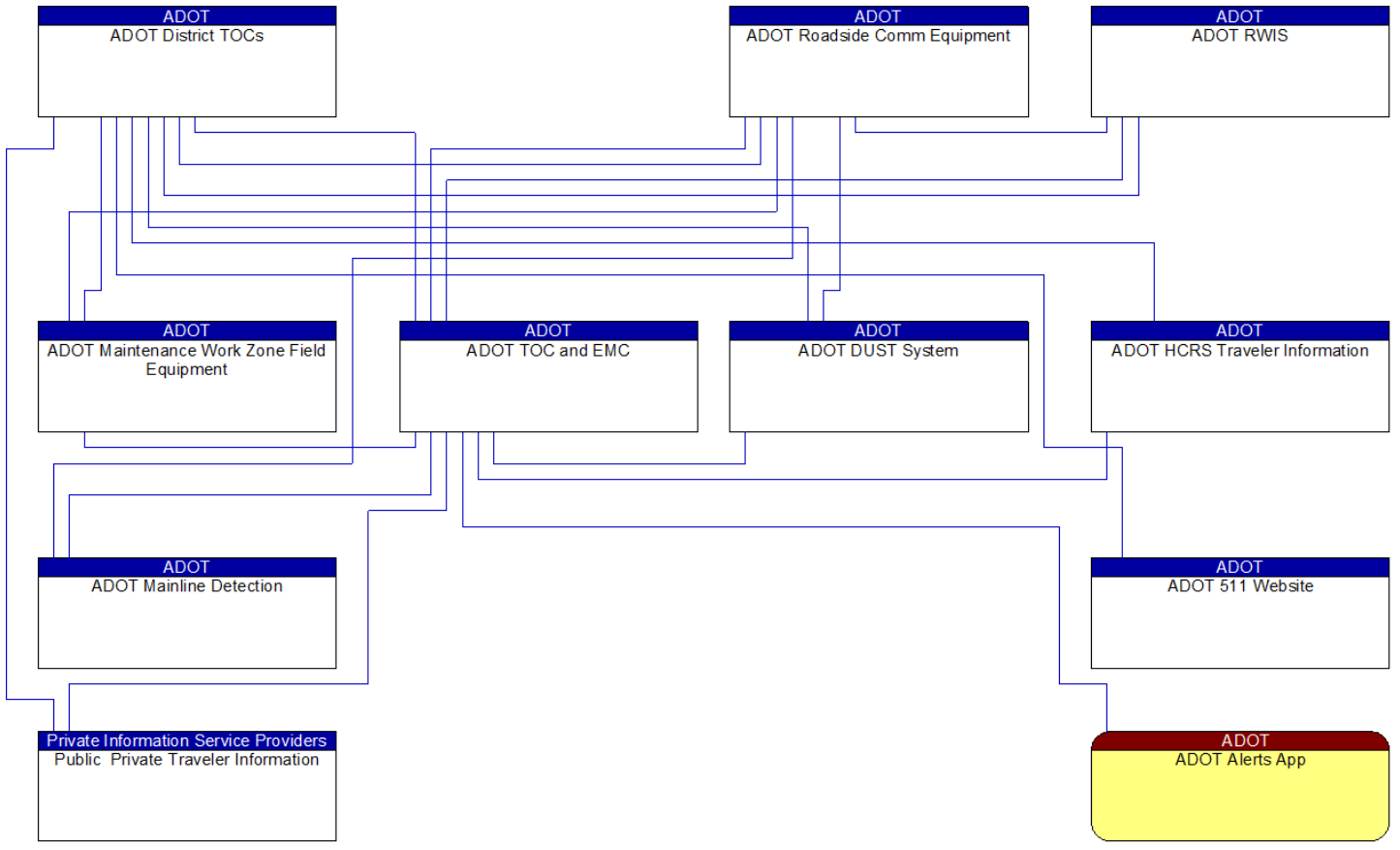

Existing

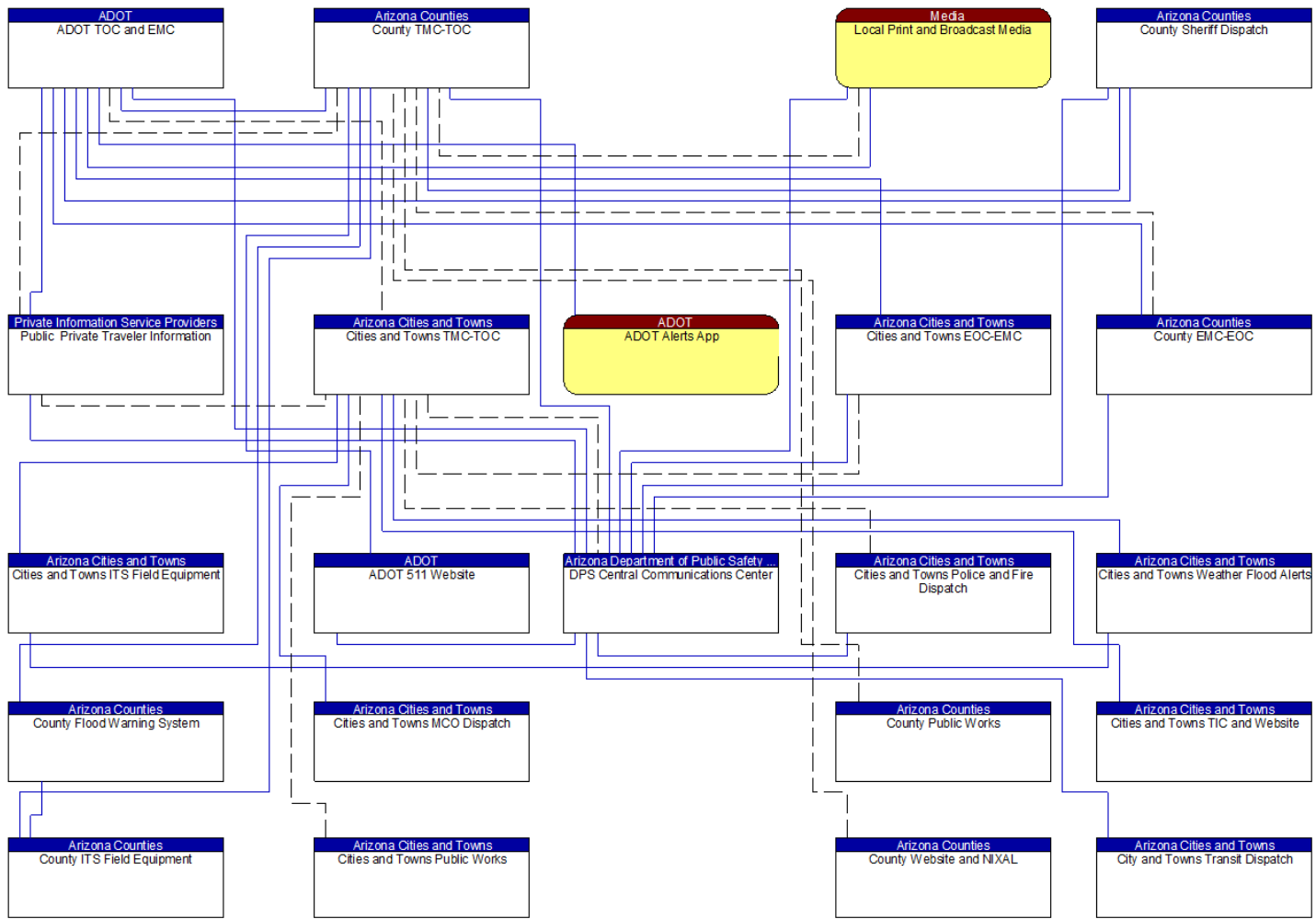

——— Existing
- - - - - Planned

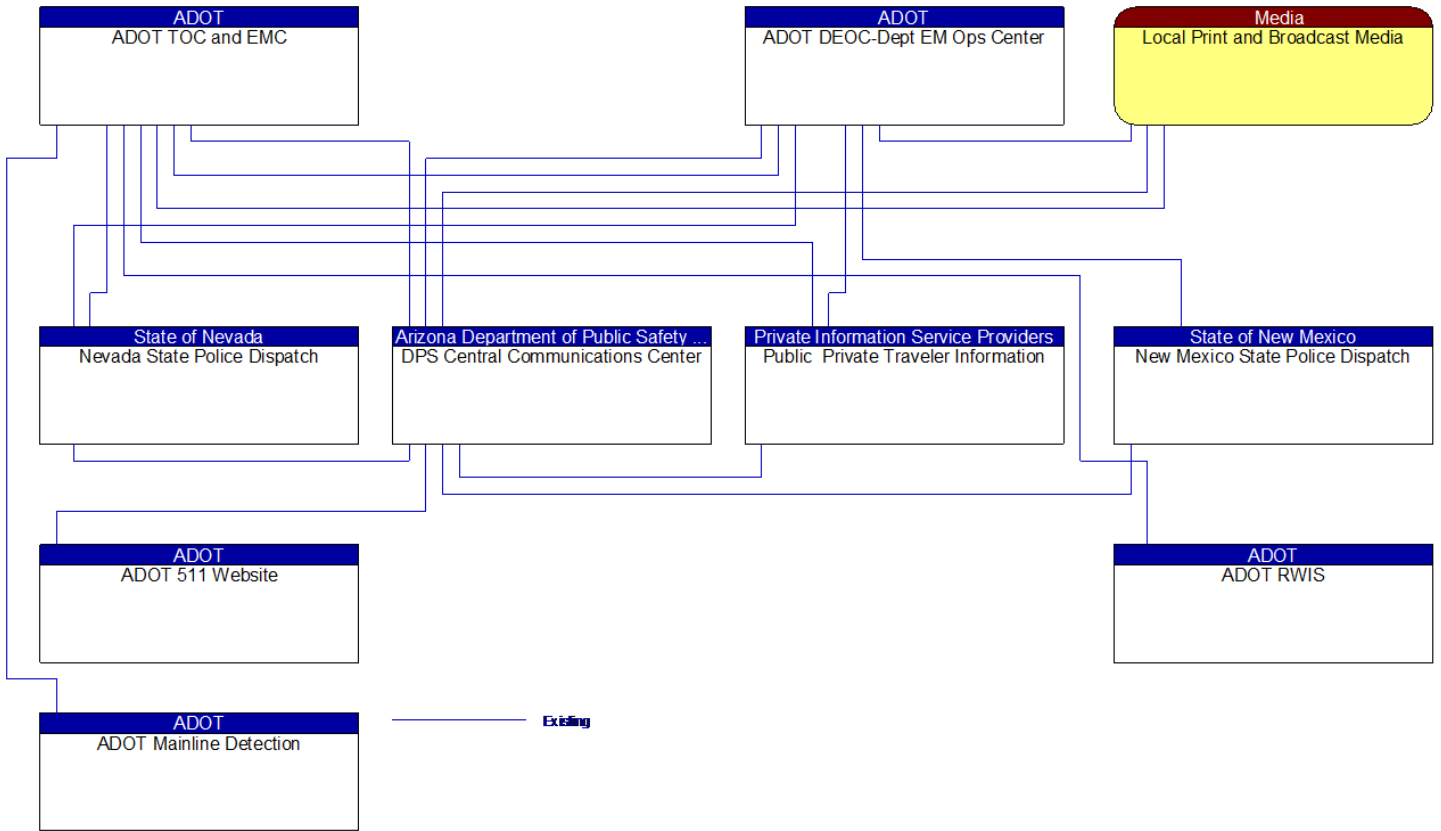

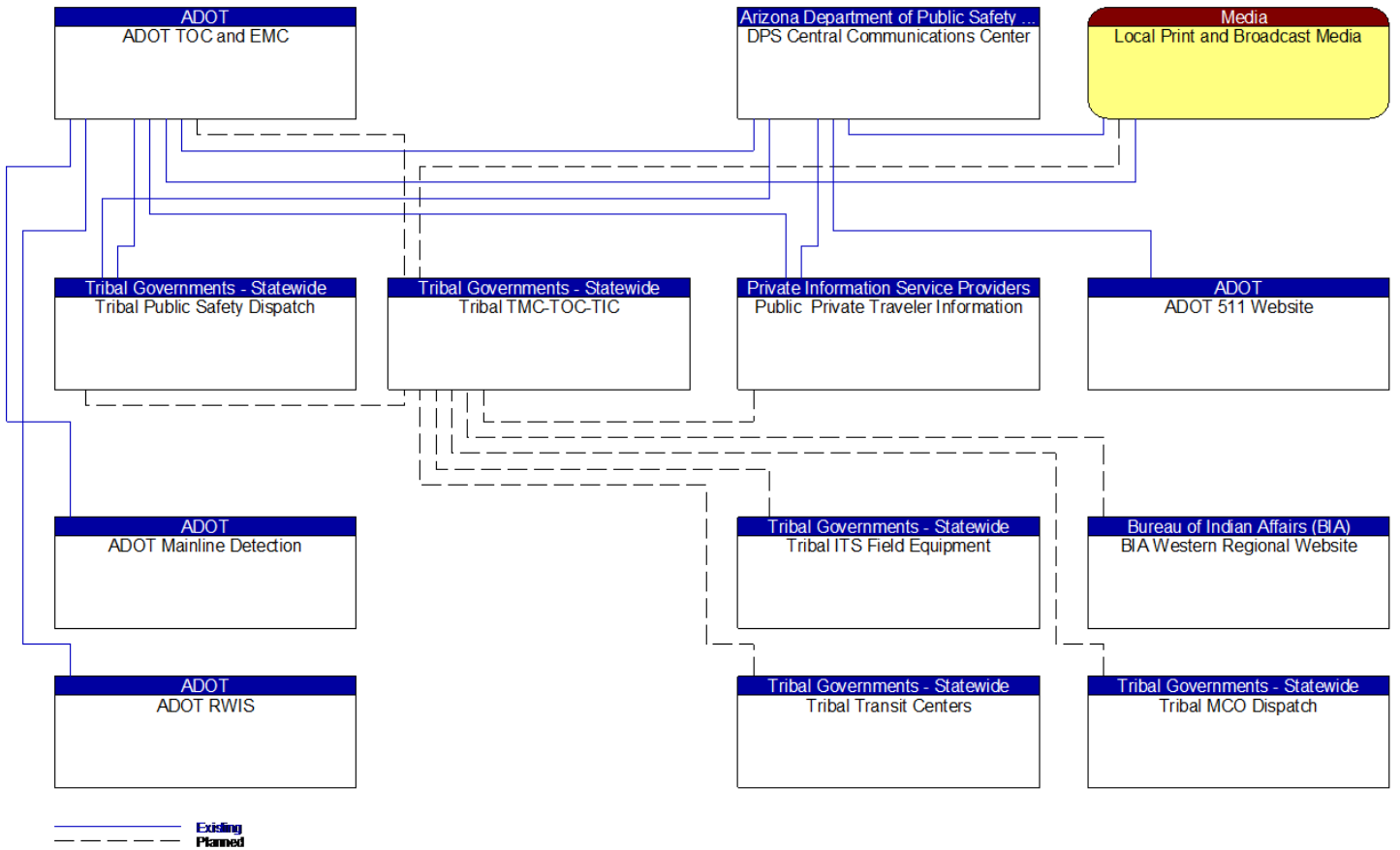

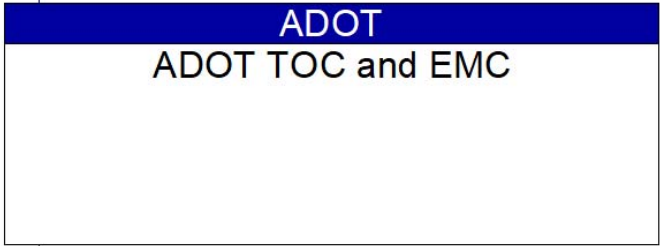
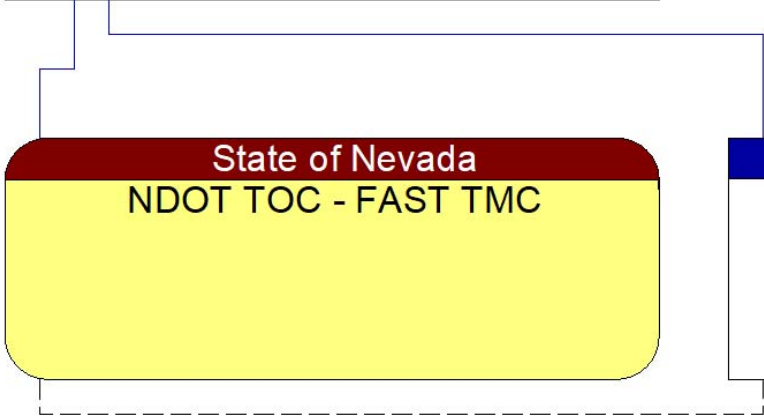
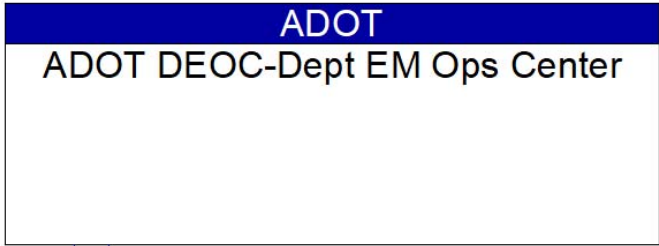

———— Existing
----- Planned

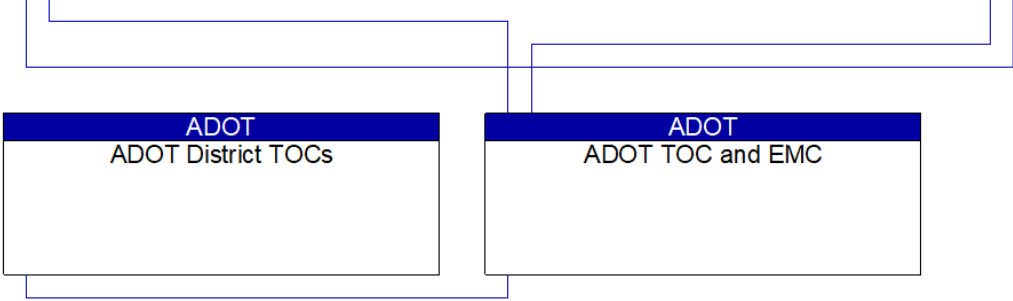
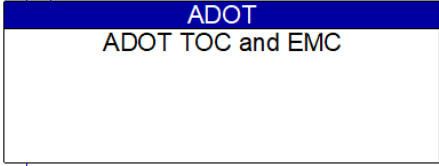
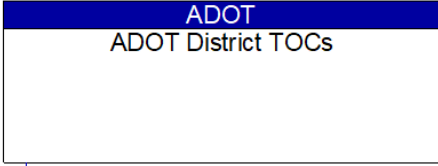
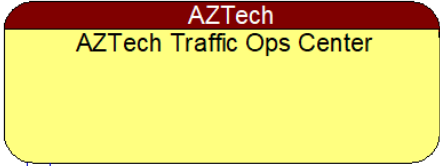
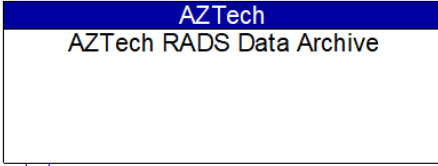

Existing

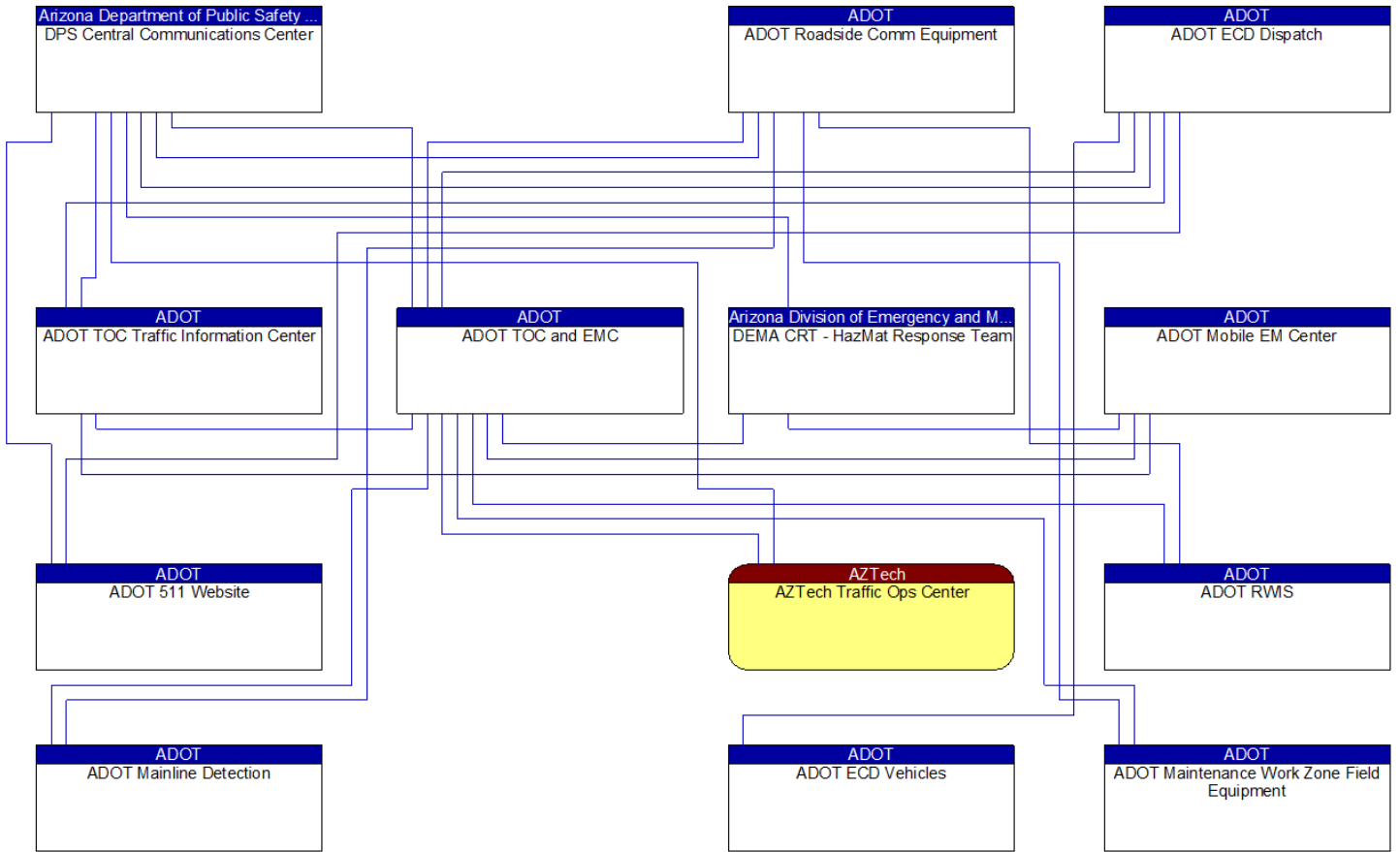

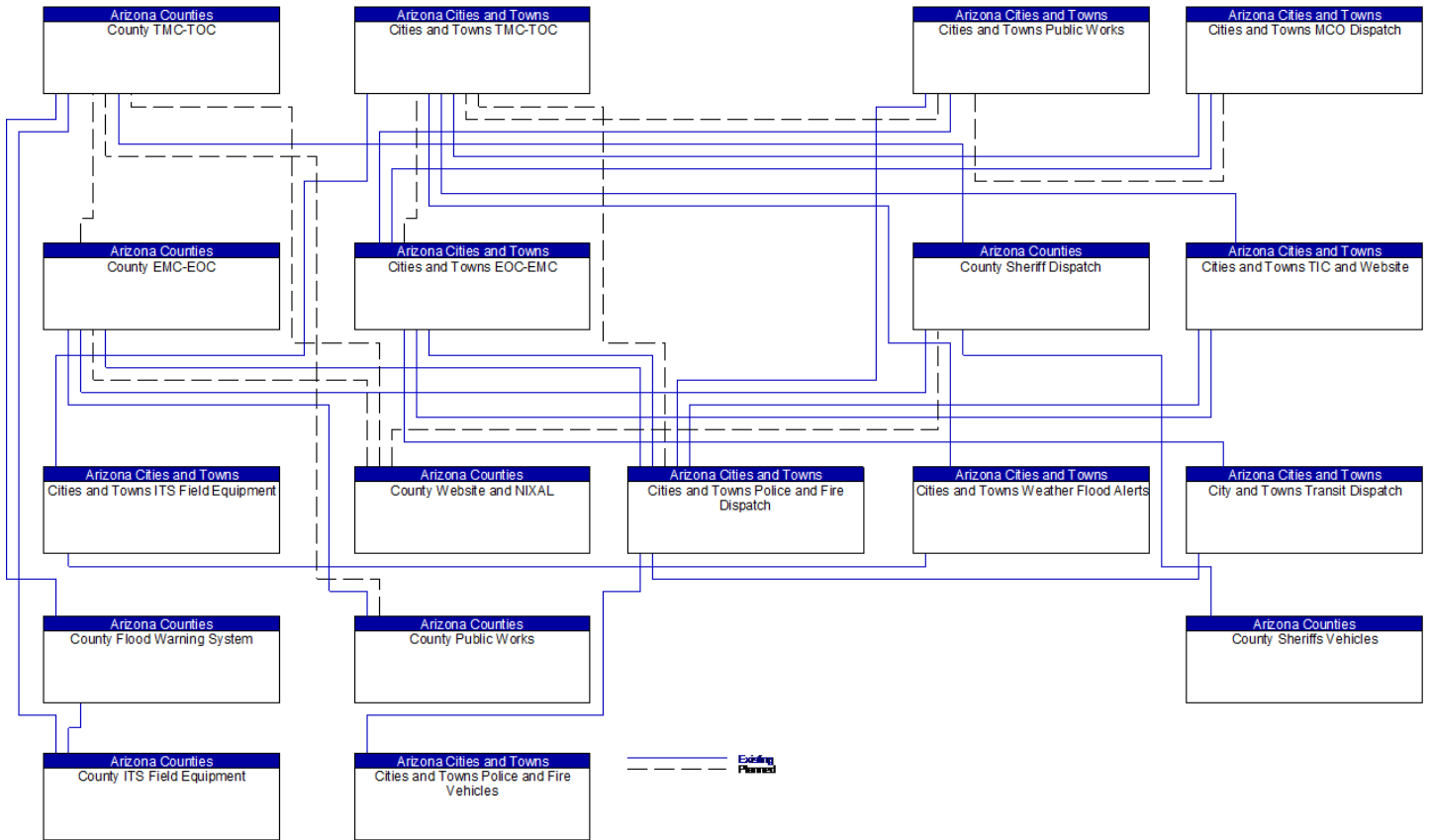

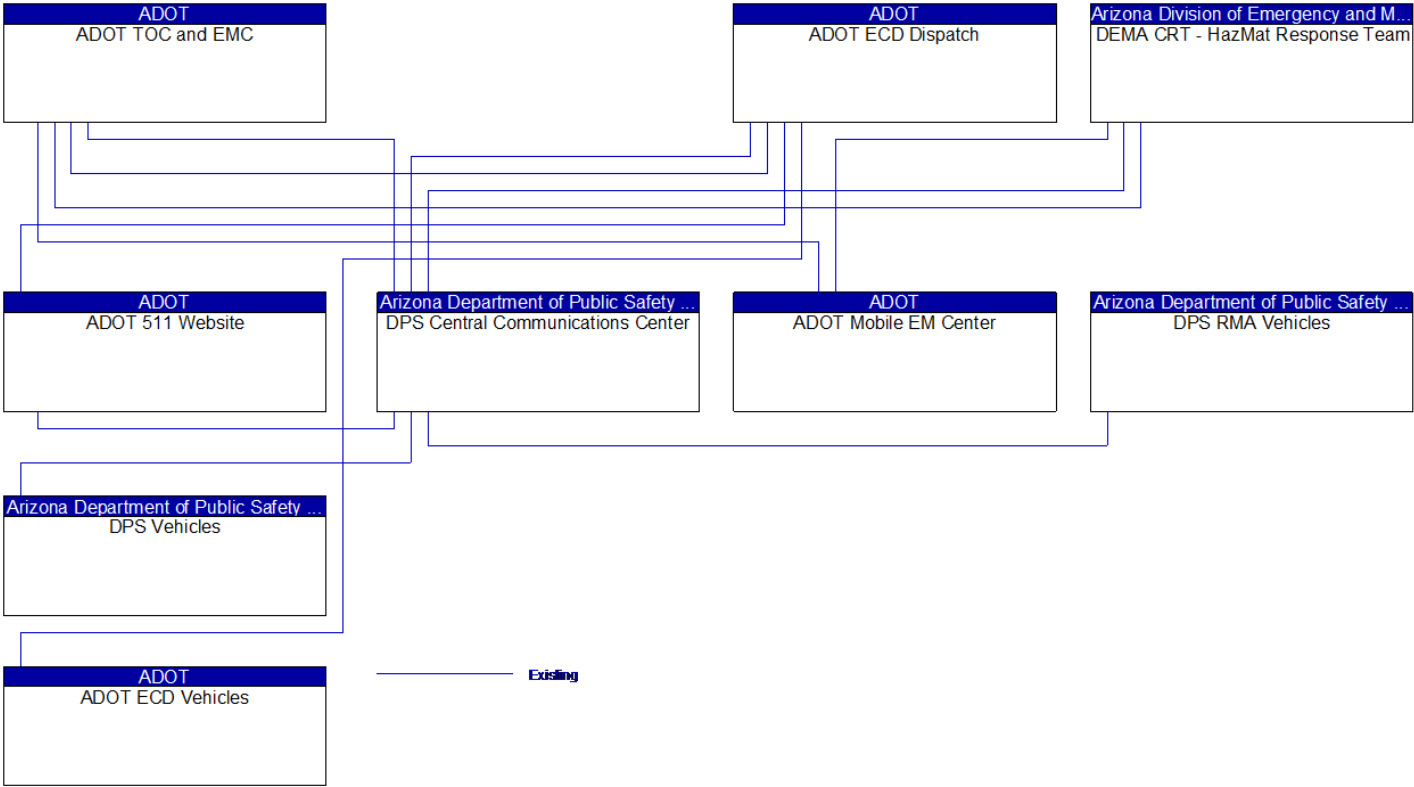

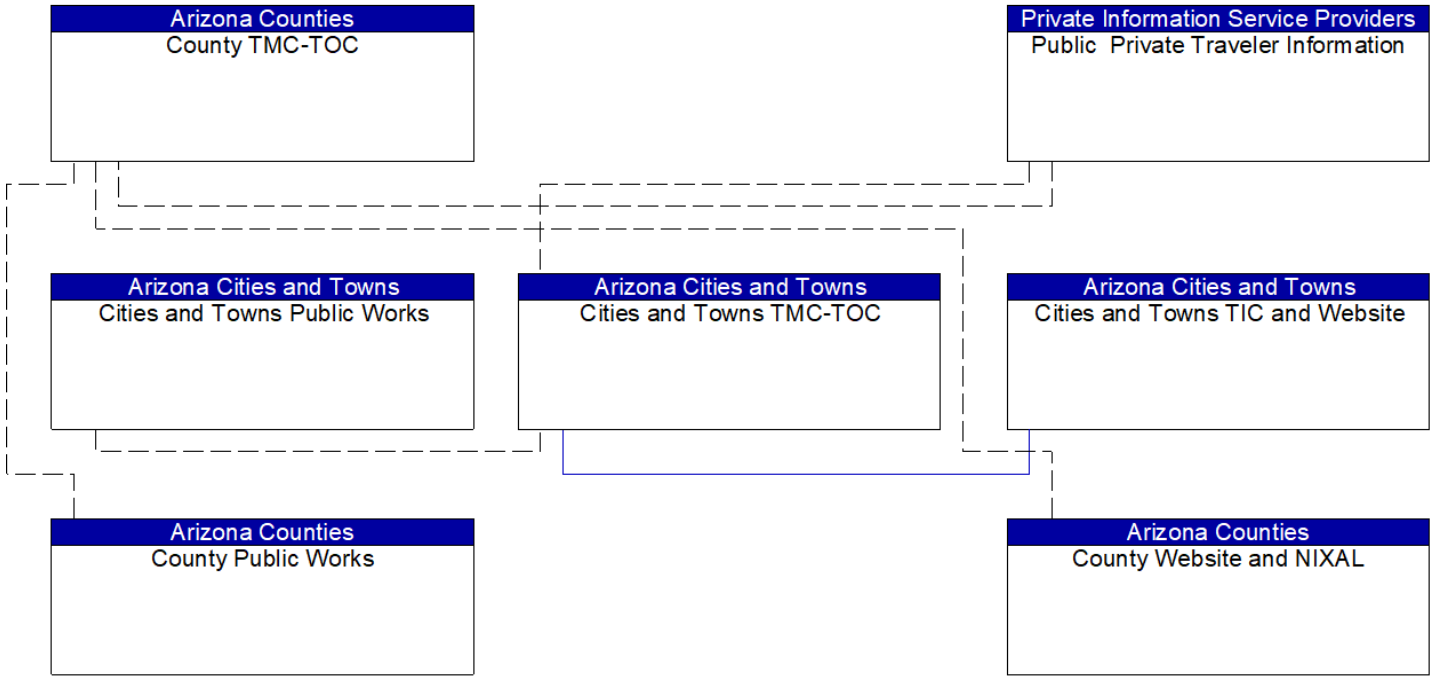

— Existing
 - - - Planned

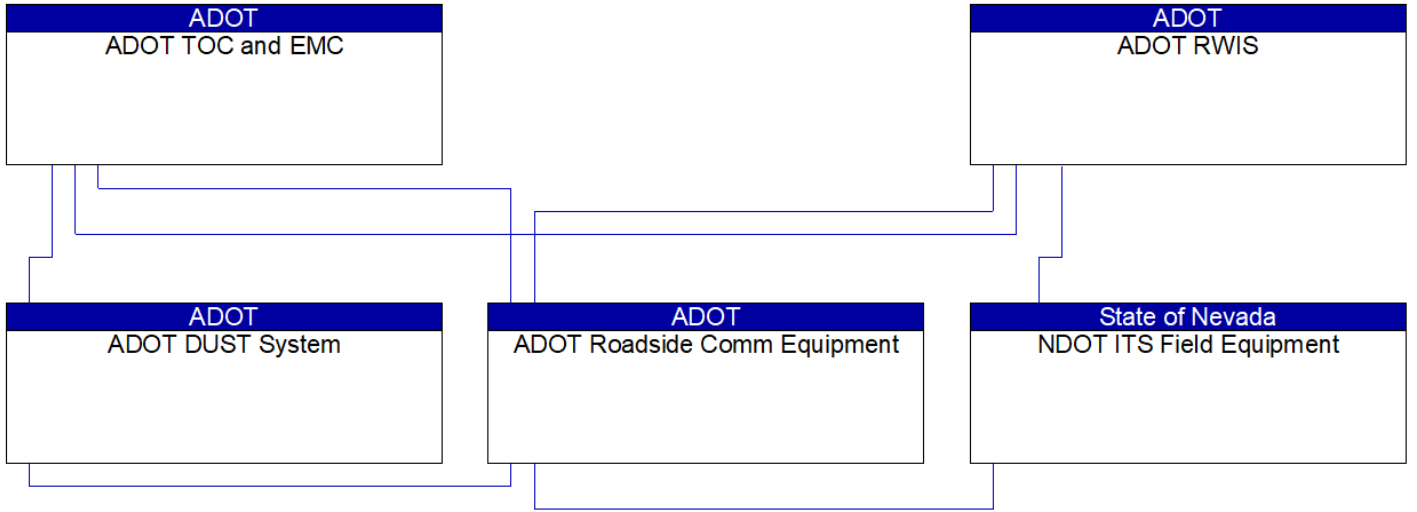

Existing

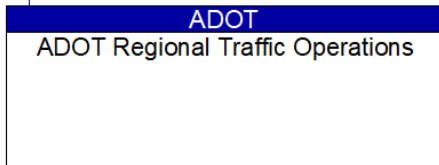
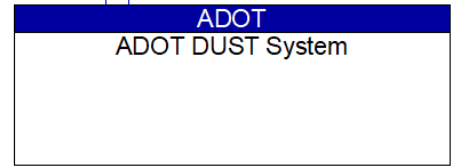
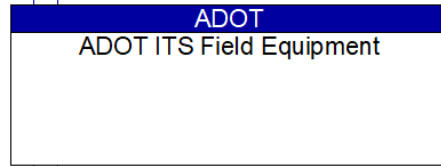
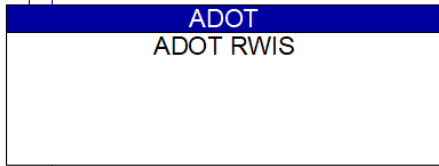
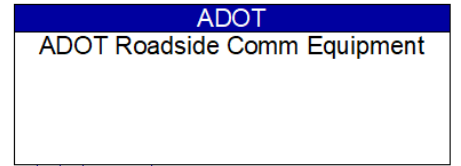
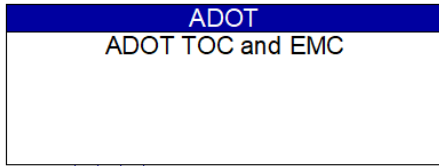

Existing

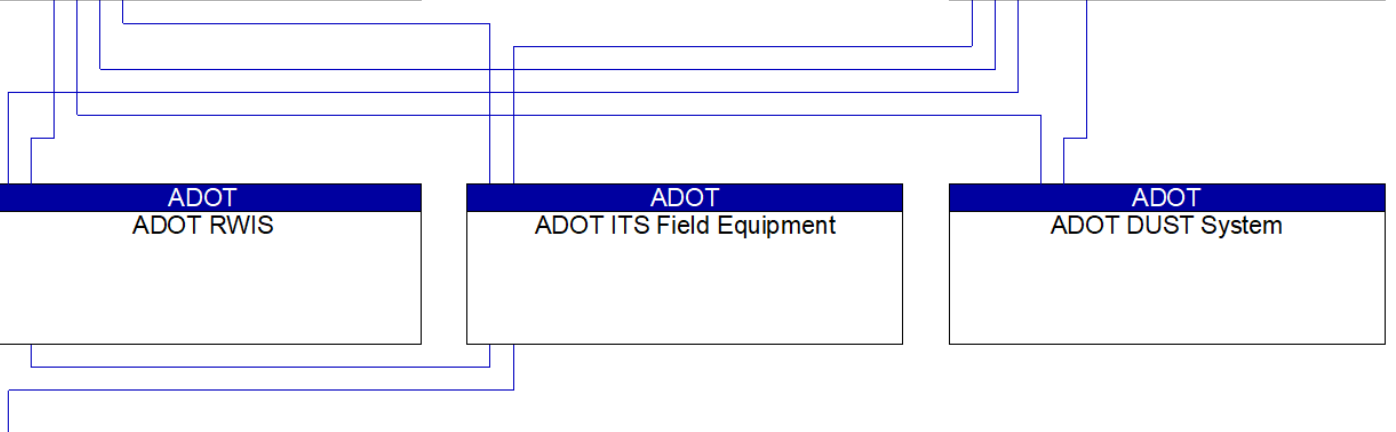

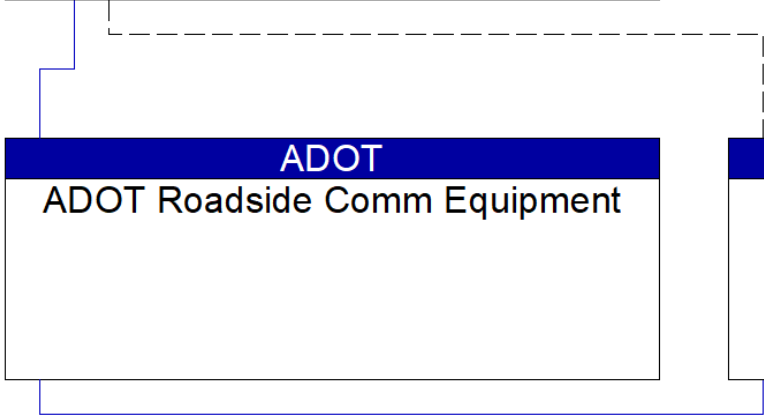
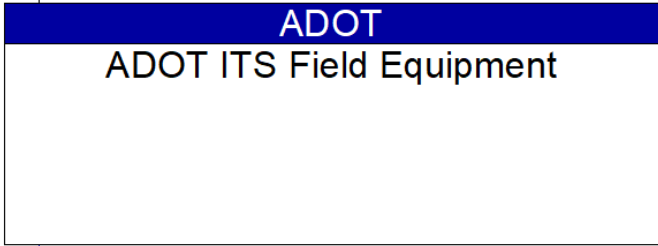
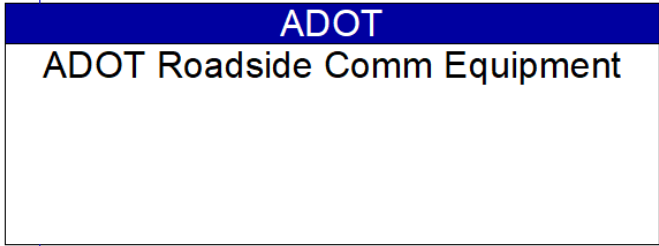
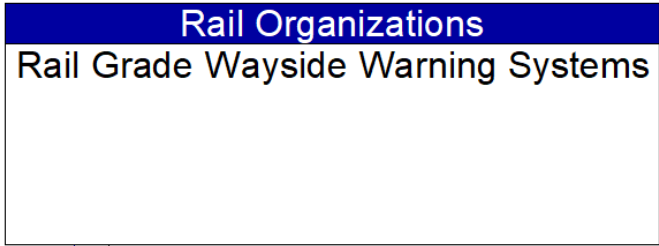

———— Existing
----- Planned

Arizona Cities and Towns
Cities and Towns ITS Field Equipment

Arizona Cities and Towns
Cities and Towns TMC-TOC

Arizona Cities and Towns
Cities and Towns Weather Flood Alerts

Rail Organizations
Rail Grade Wayside Warning Systems

Arizona Cities and Towns
Cities and Towns Train Wayside Alert

Arizona Counties
County ITS Field Equipment

Existing
Planned

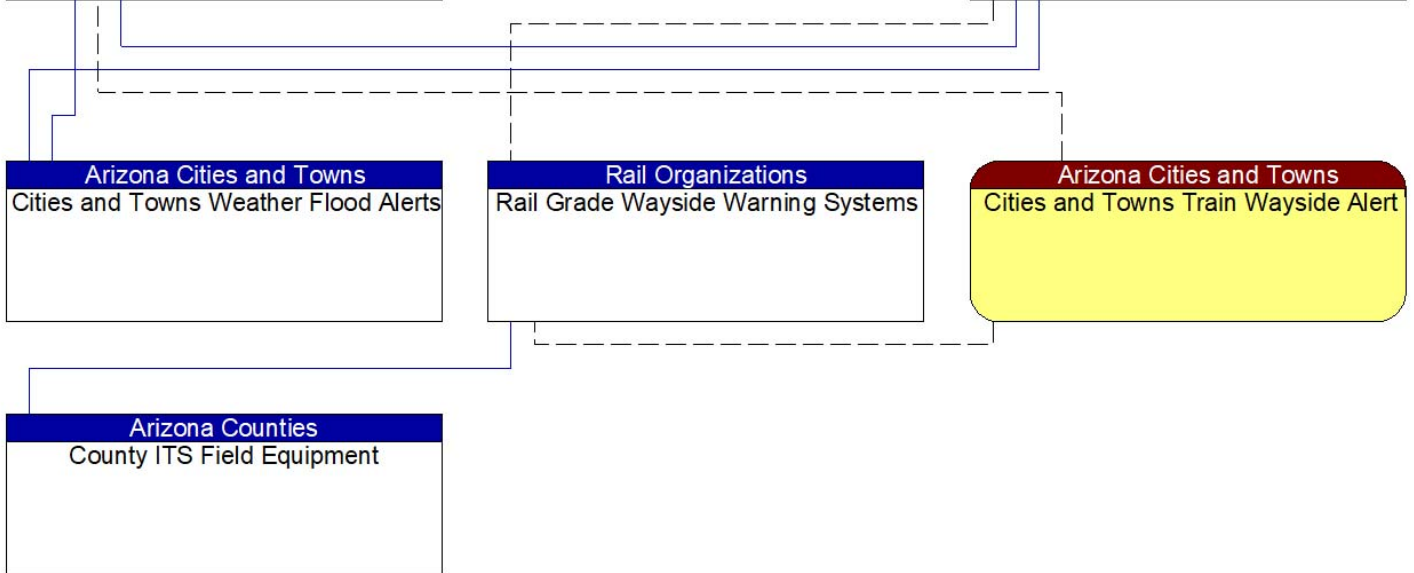

ADOT

ADOT Roadside Comm Equipment

Rail Organizations

Rail Grade Wayside Warning Systems

Existing

Tribal Governments - Statewide

Tribal ITS Field Equipment

Rail Organizations

Rail Grade Wayside Warning Systems

----- **Planned**

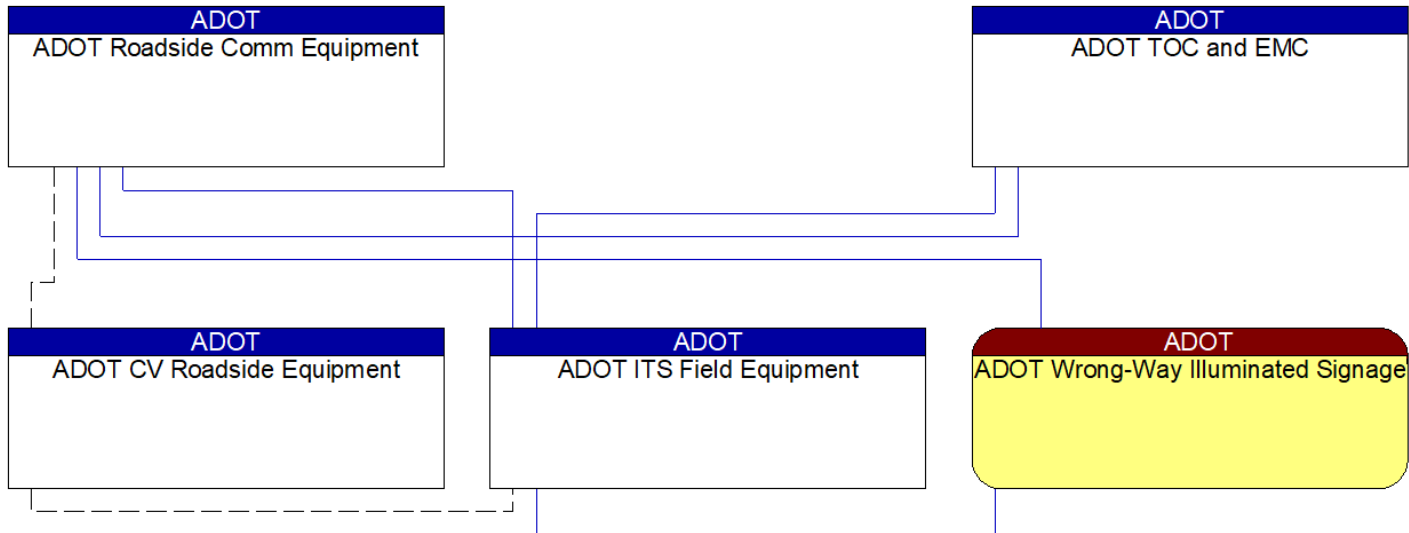

———— Existing
----- Planned

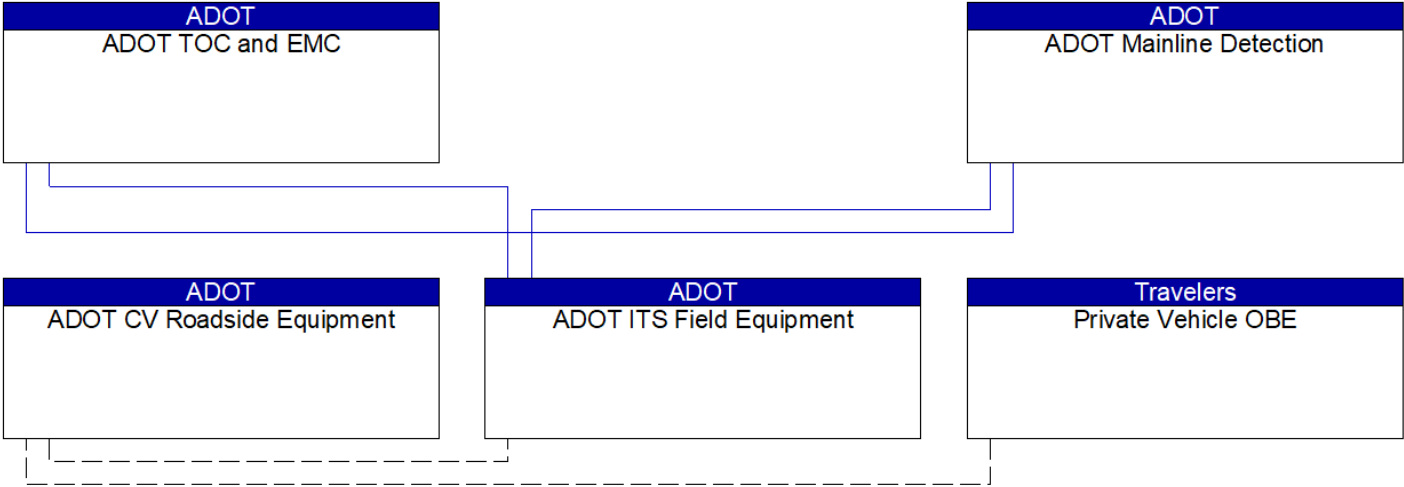

———— Existing
----- Planned

Arizona Cities and Towns
Cities and Towns TMC-TOC

Arizona Counties
County ITS Field Equipment

Arizona Counties
County TMC-TOC

Arizona Cities and Towns
Cities and Towns ITS Field Equipment

Existing

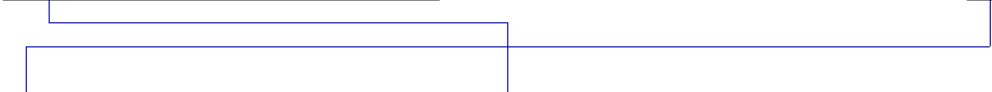

Tribal Governments - Statewide
Tribal TMC-TOC-TIC

Tribal Governments - Statewide
Tribal ITS Field Equipment

----- **Planned**

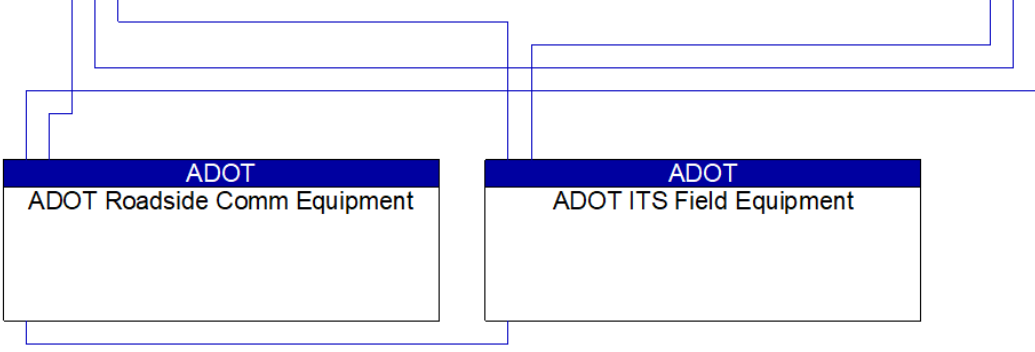
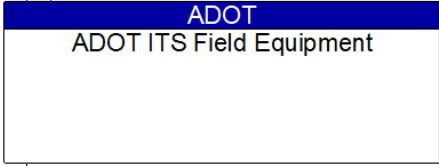
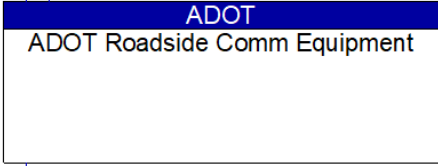
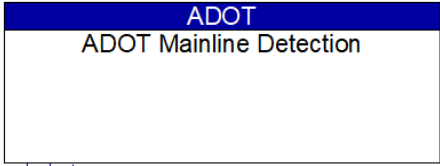
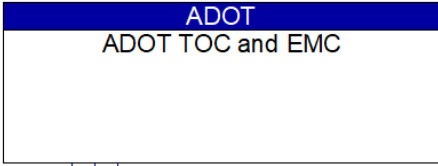

Existing

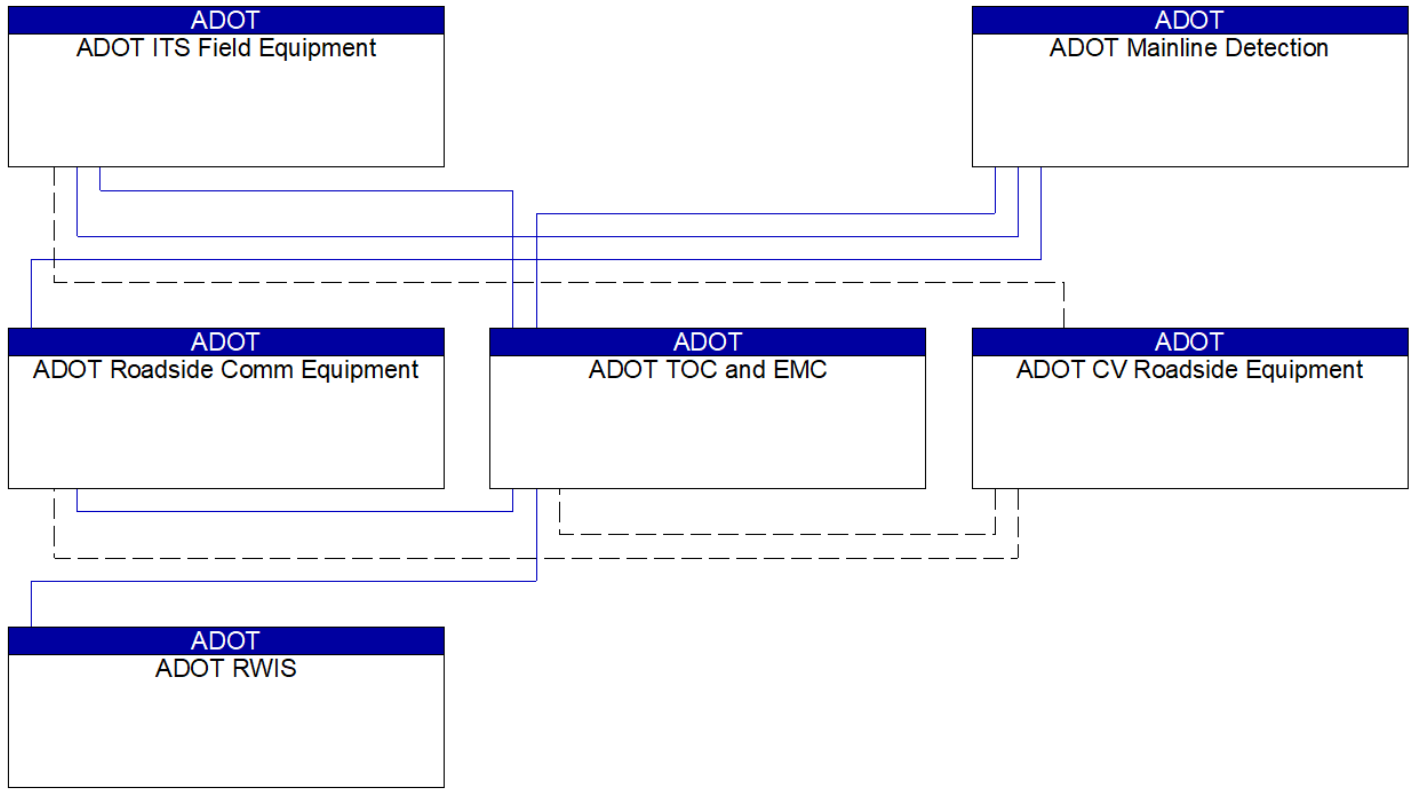

Existing
 Planned

US Customs and Border Protection (...)
POE Roadway Inspection Systems

Private Information Service Providers
Public Private Traveler Information

US Customs and Border Protection (...)
POE Administration Center

US Immigration and Customs Enforc...
US VISIT System

ADOT
ADOT TOC Traffic Information Center

US Customs and Border Protection (...)
CBP Website

Existing

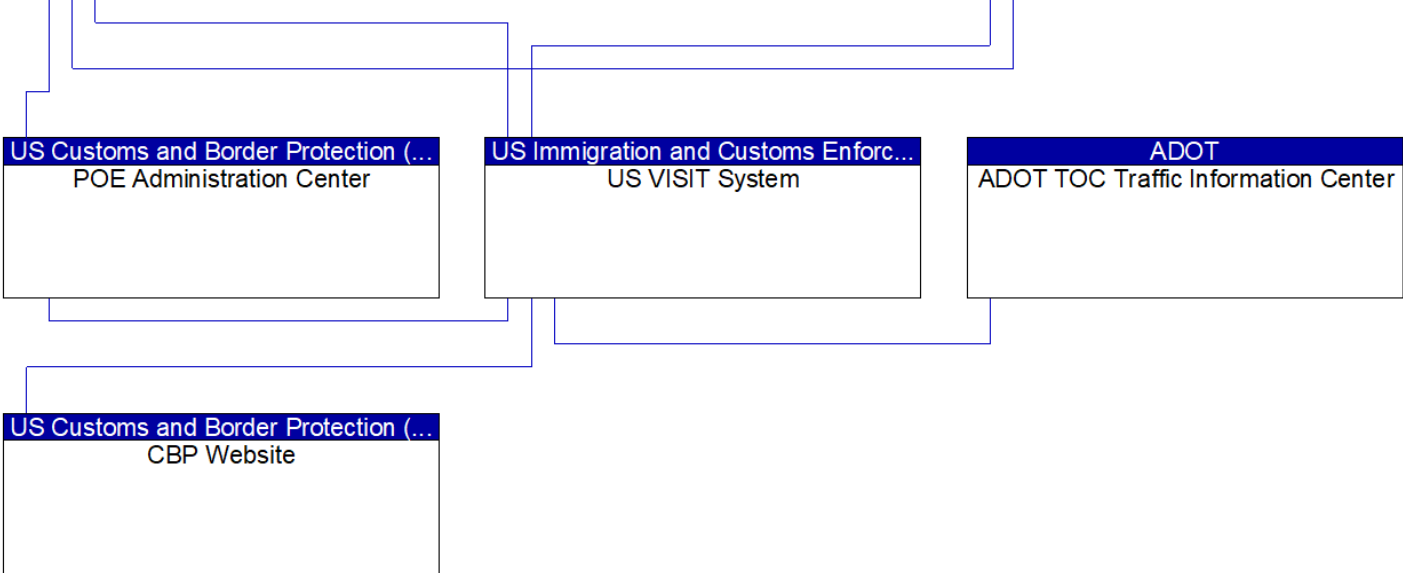

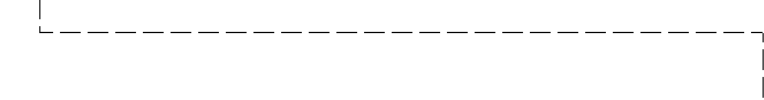
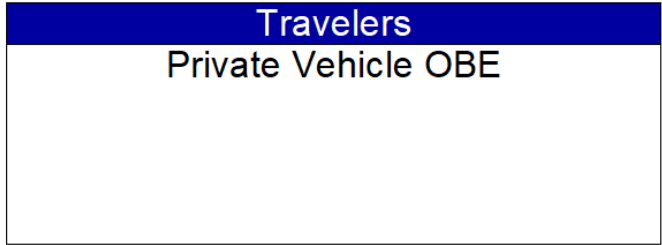
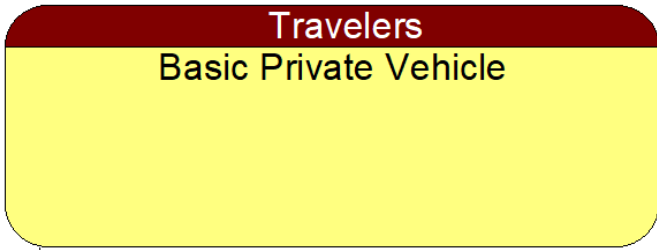

----- **Planned**

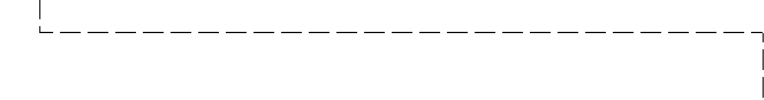
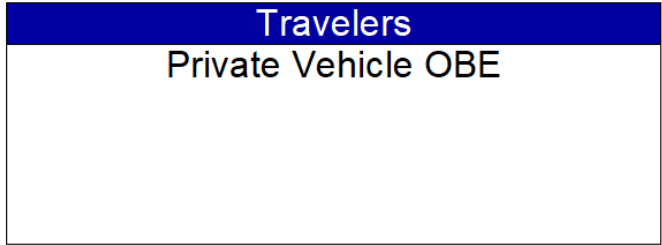
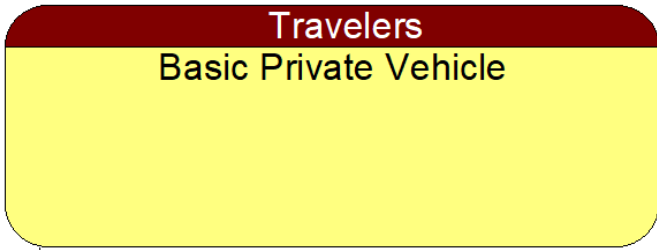

----- **Planned**

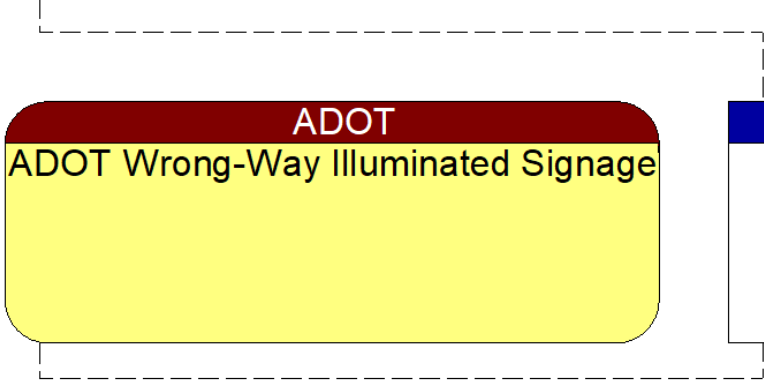
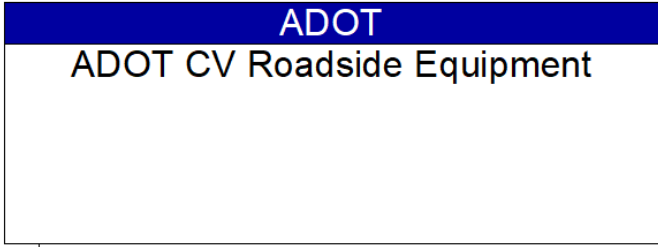
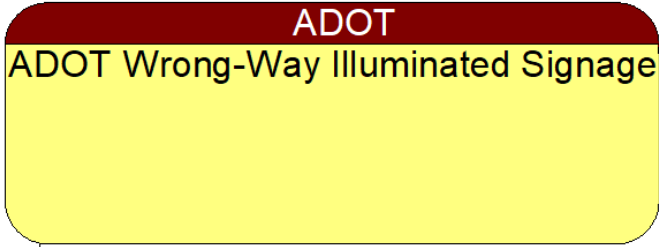
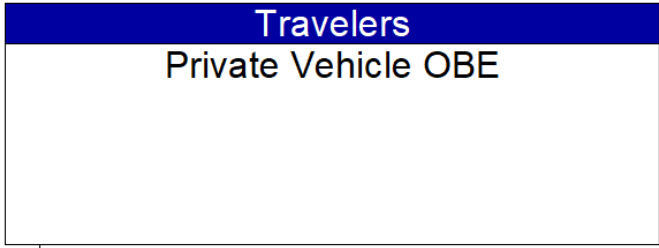

----- **Planned**

Arizona Department of Public Safety ...
DPS RMA Vehicles

Private Commercial Carriers
Commercial Vehicles

Travelers
Private Vehicle OBE

----- **Planned**

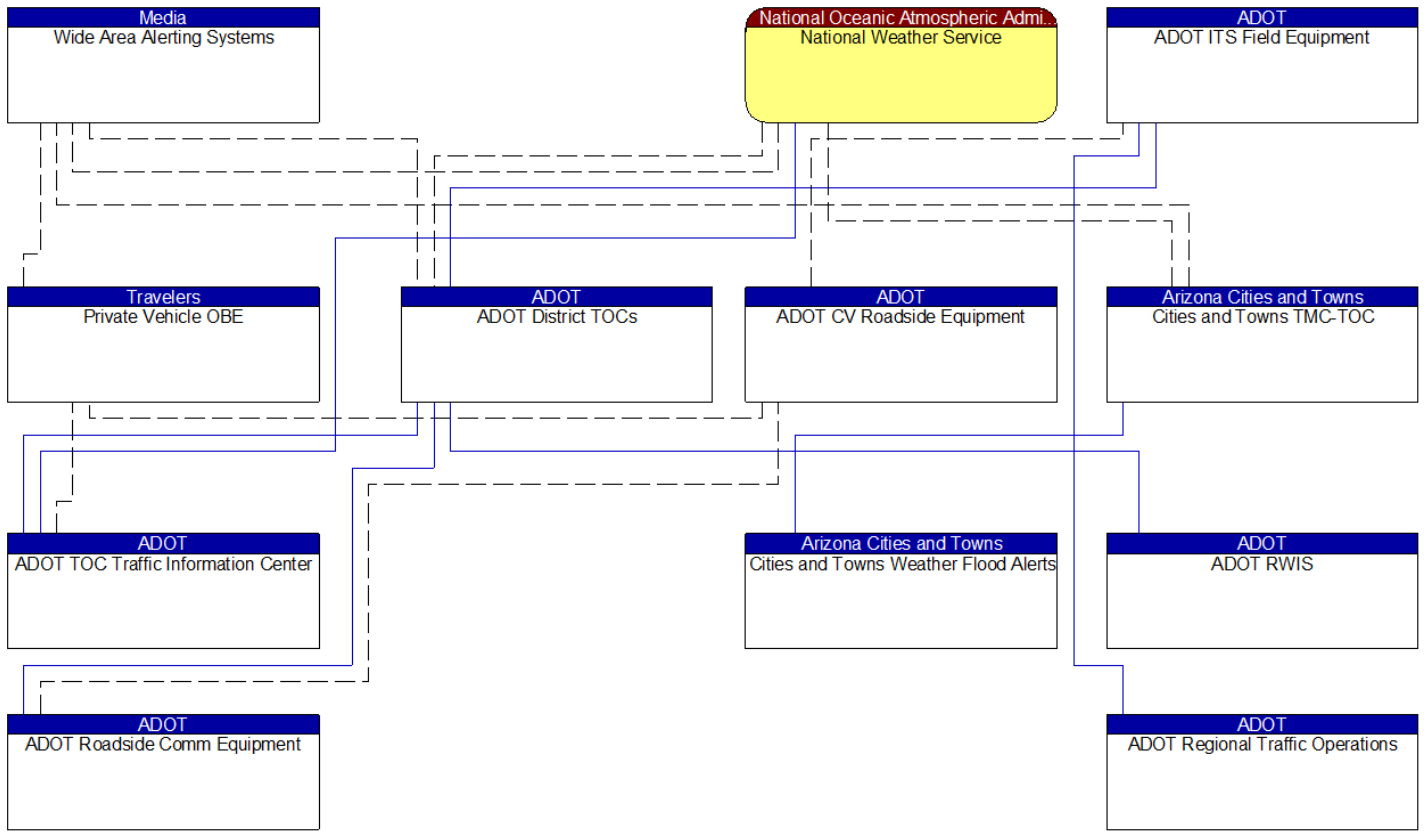

——— Existing
- - - - Planned

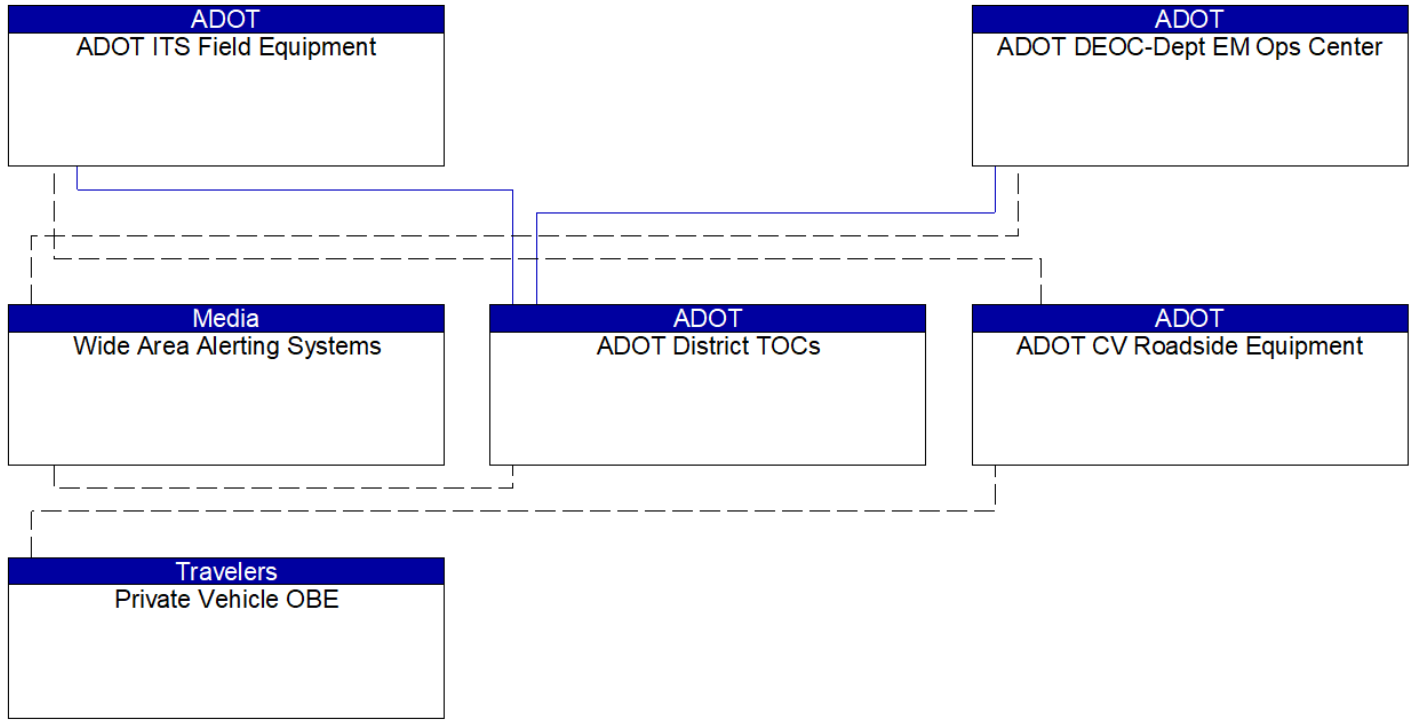

———— Existing
----- Planned

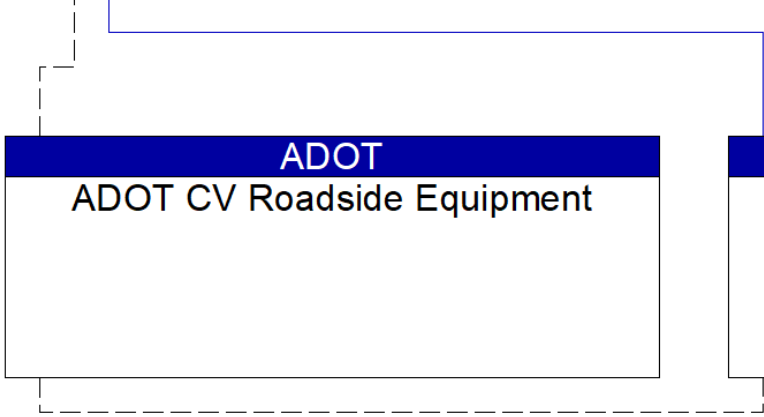
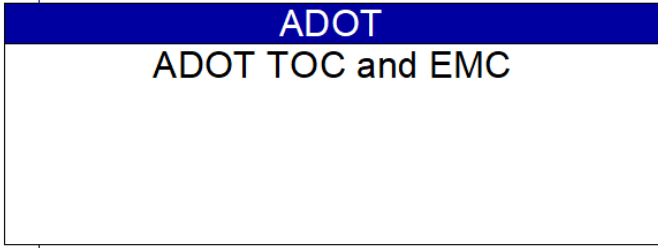
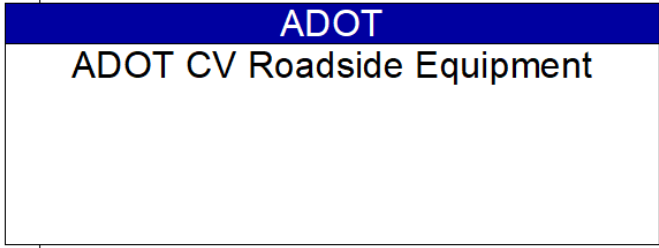
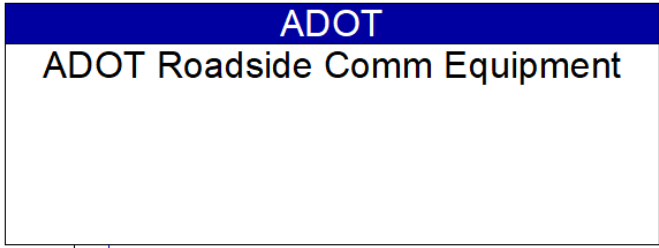

———— Existing
----- Planned

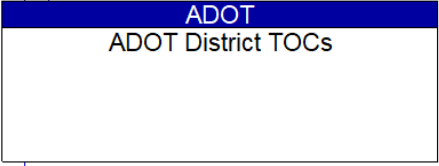
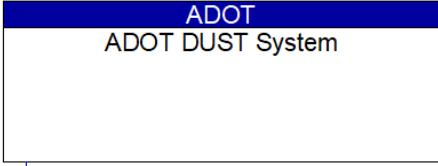
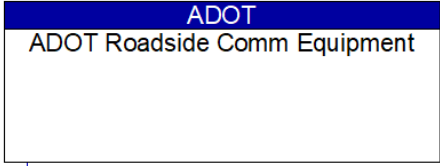
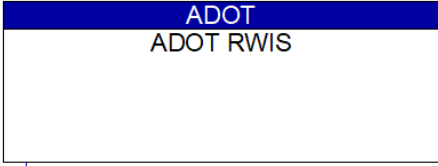

Existing

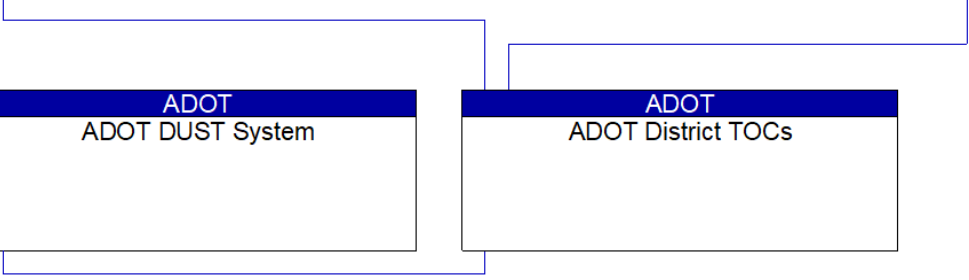

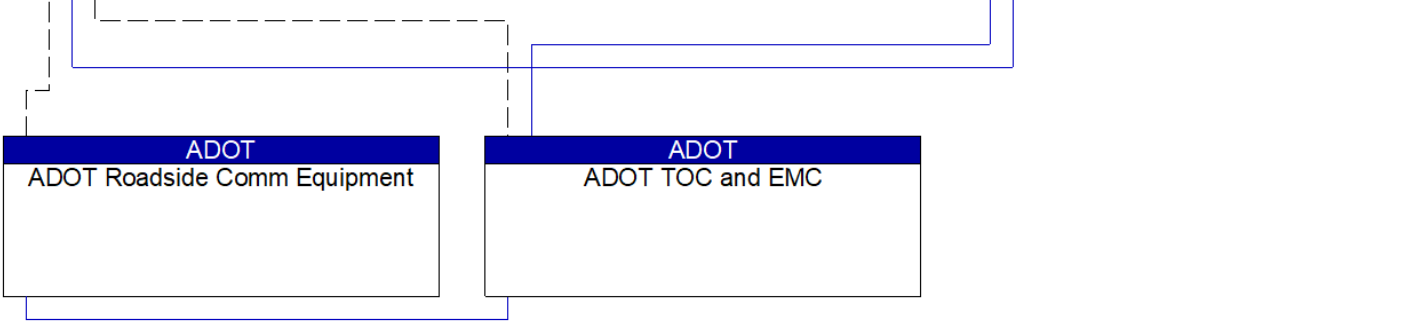
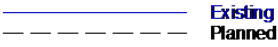
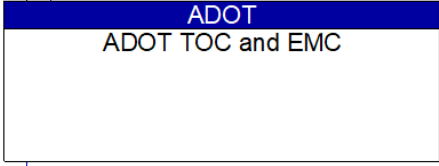
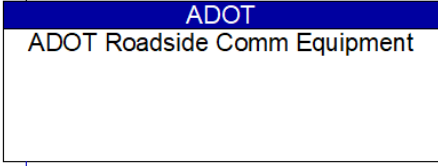
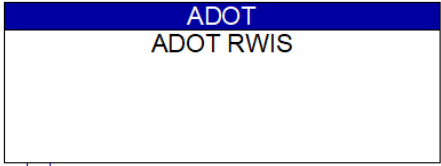
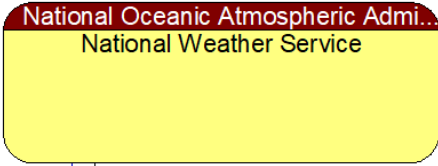

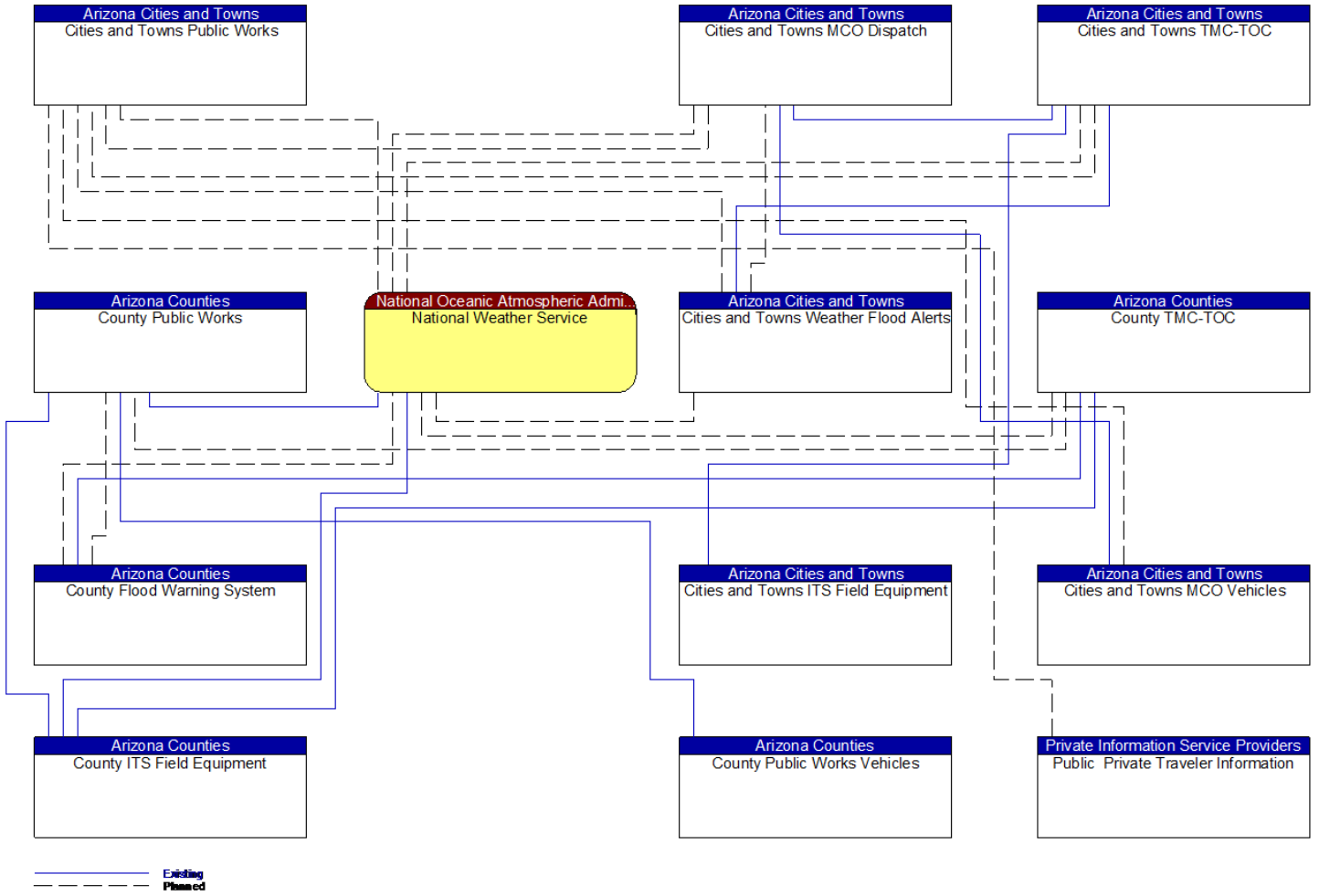

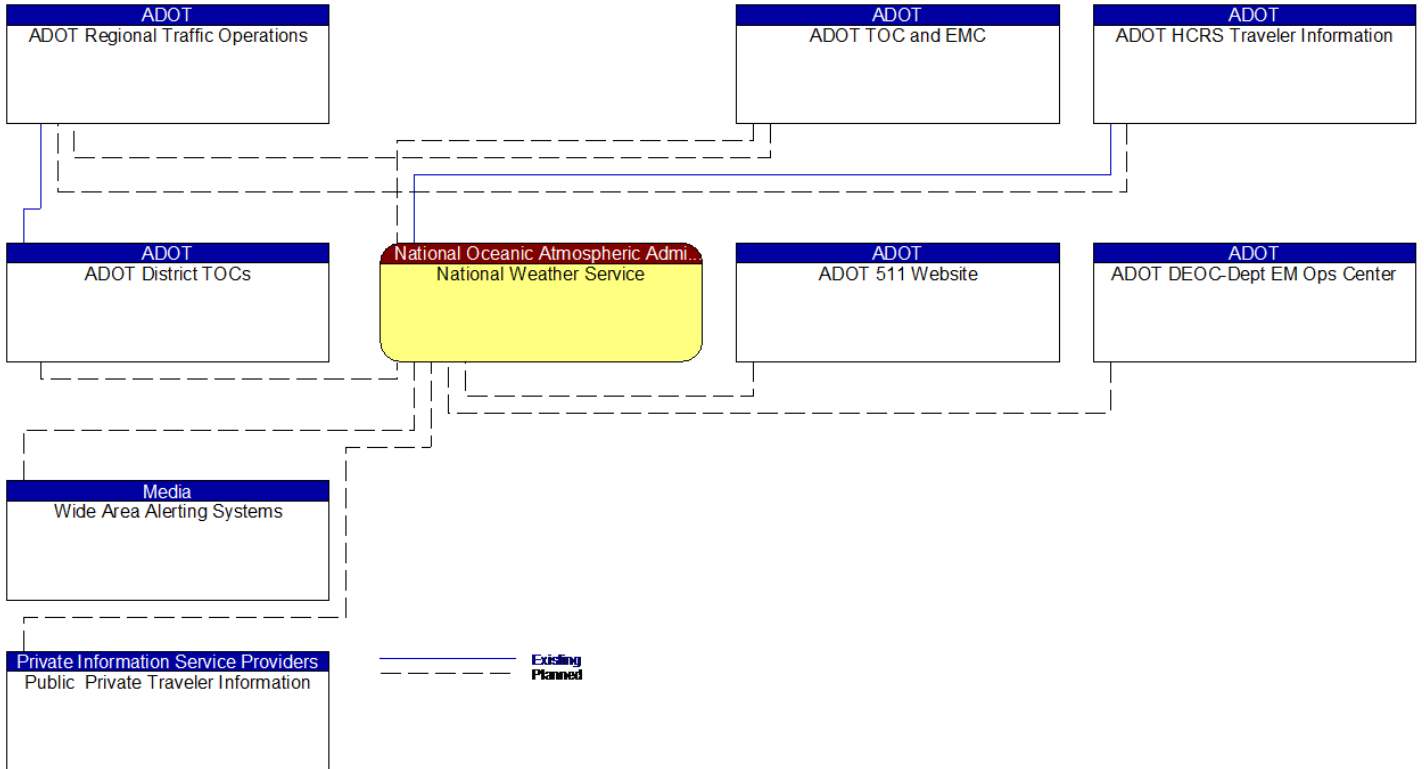

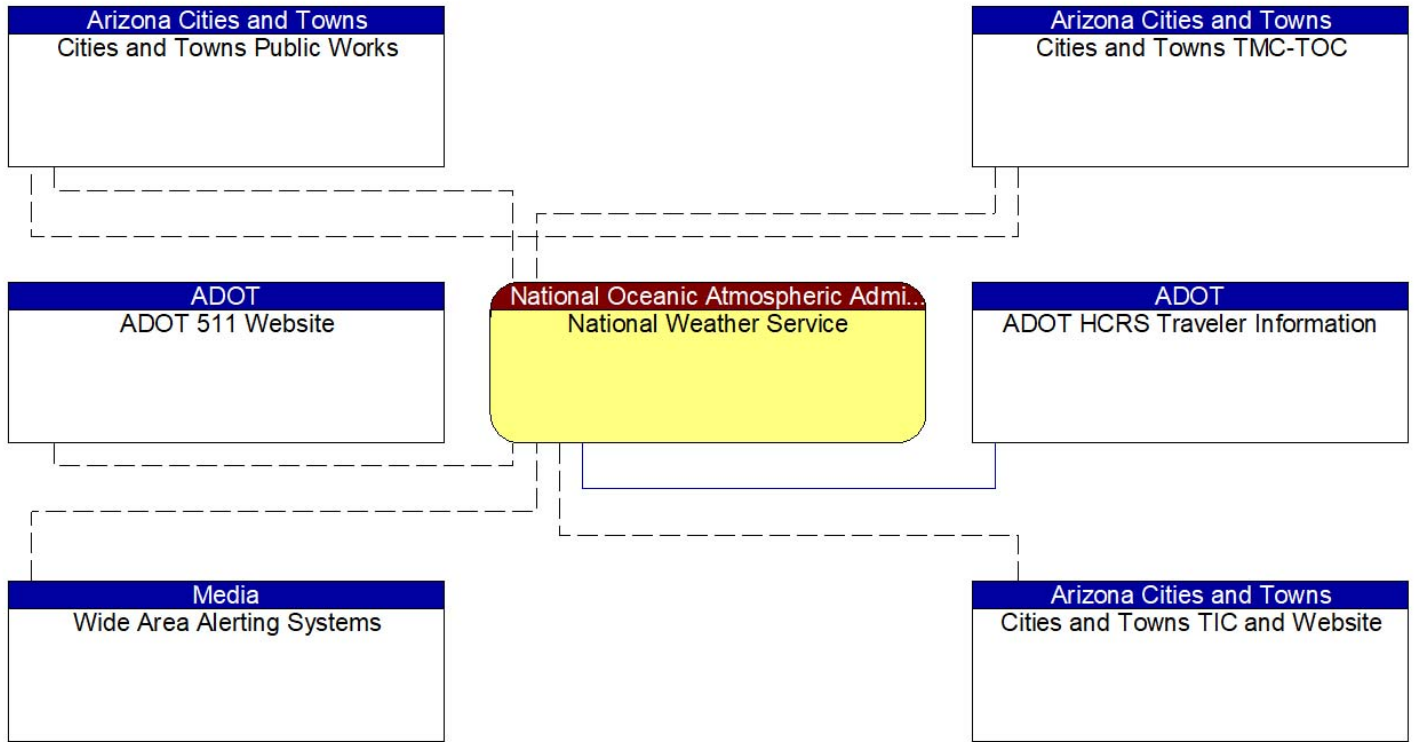

— Existing
 - - - Planned

