

# **APPENDIX I**

## **Flow Service**

### **Package Diagrams**

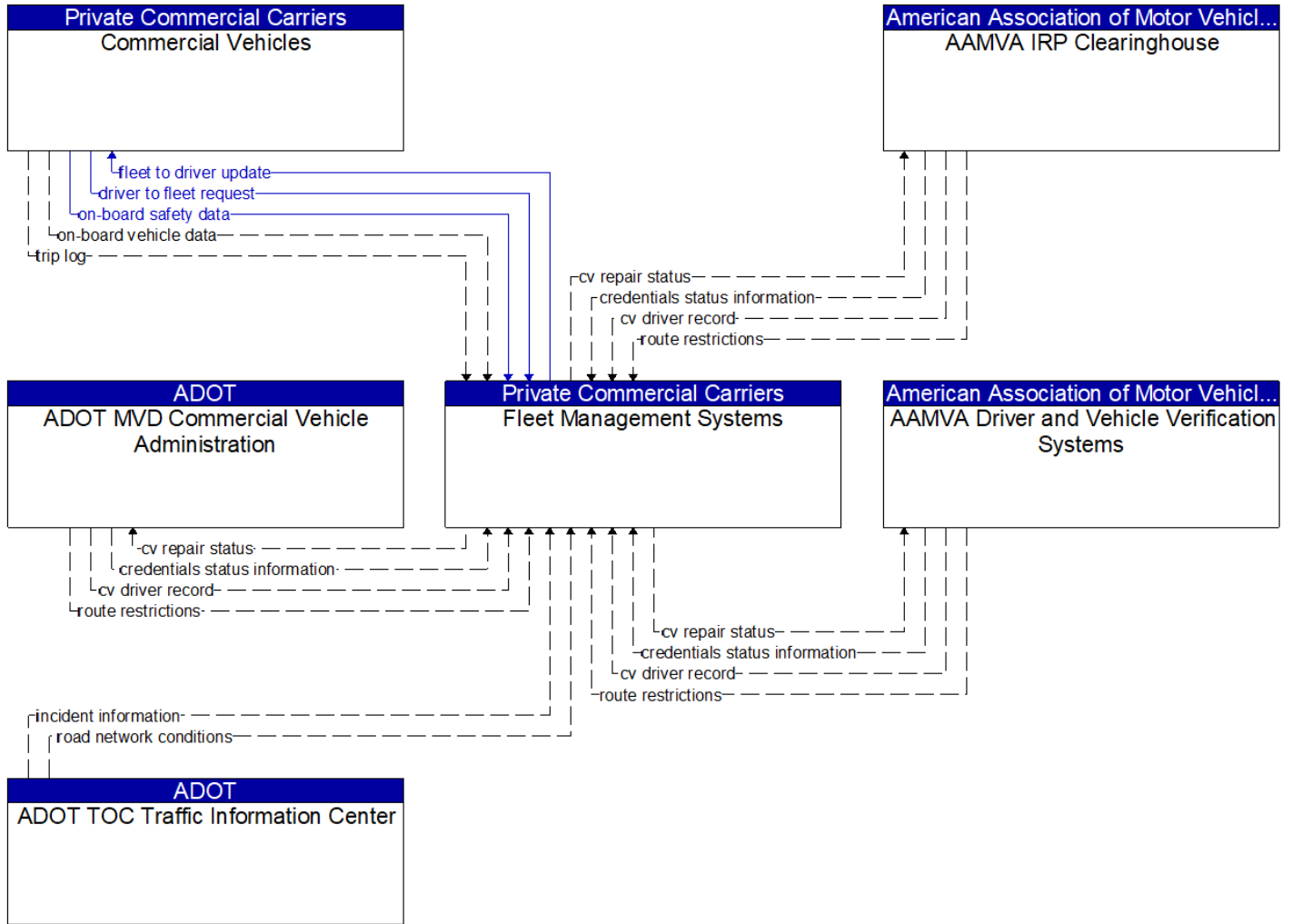

————— Existing  
 - - - - - Planned

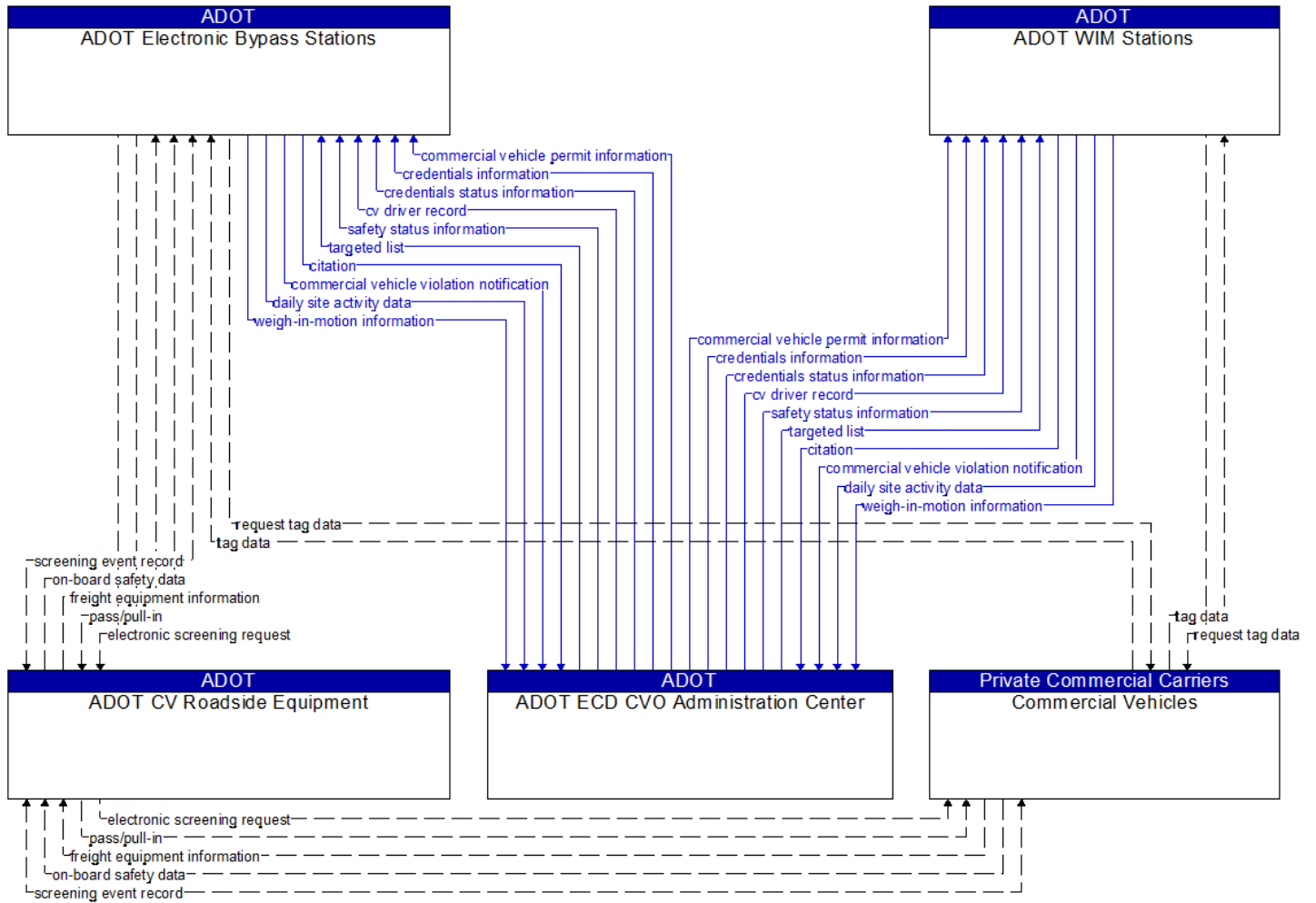

— Existing  
 - - - Planned



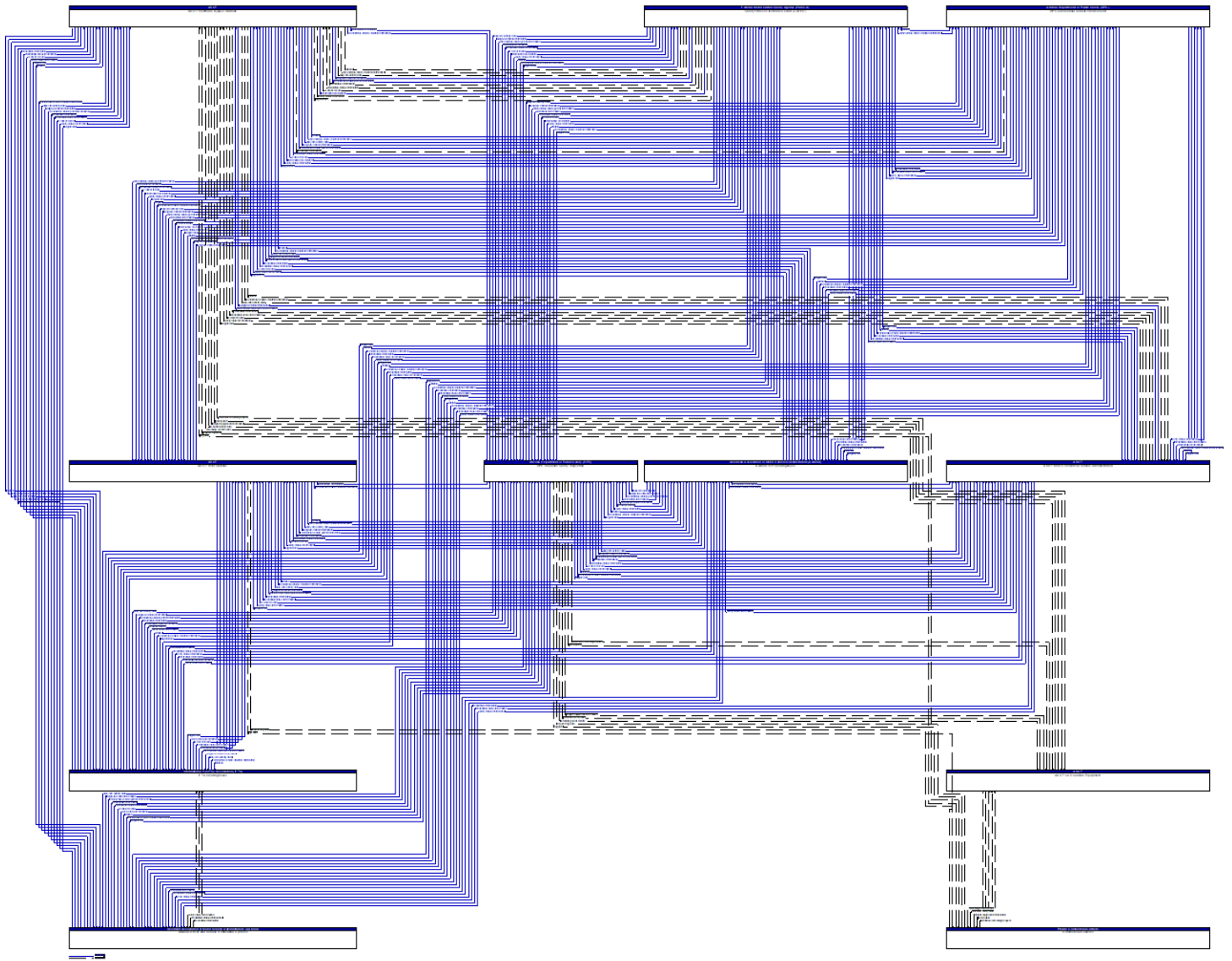

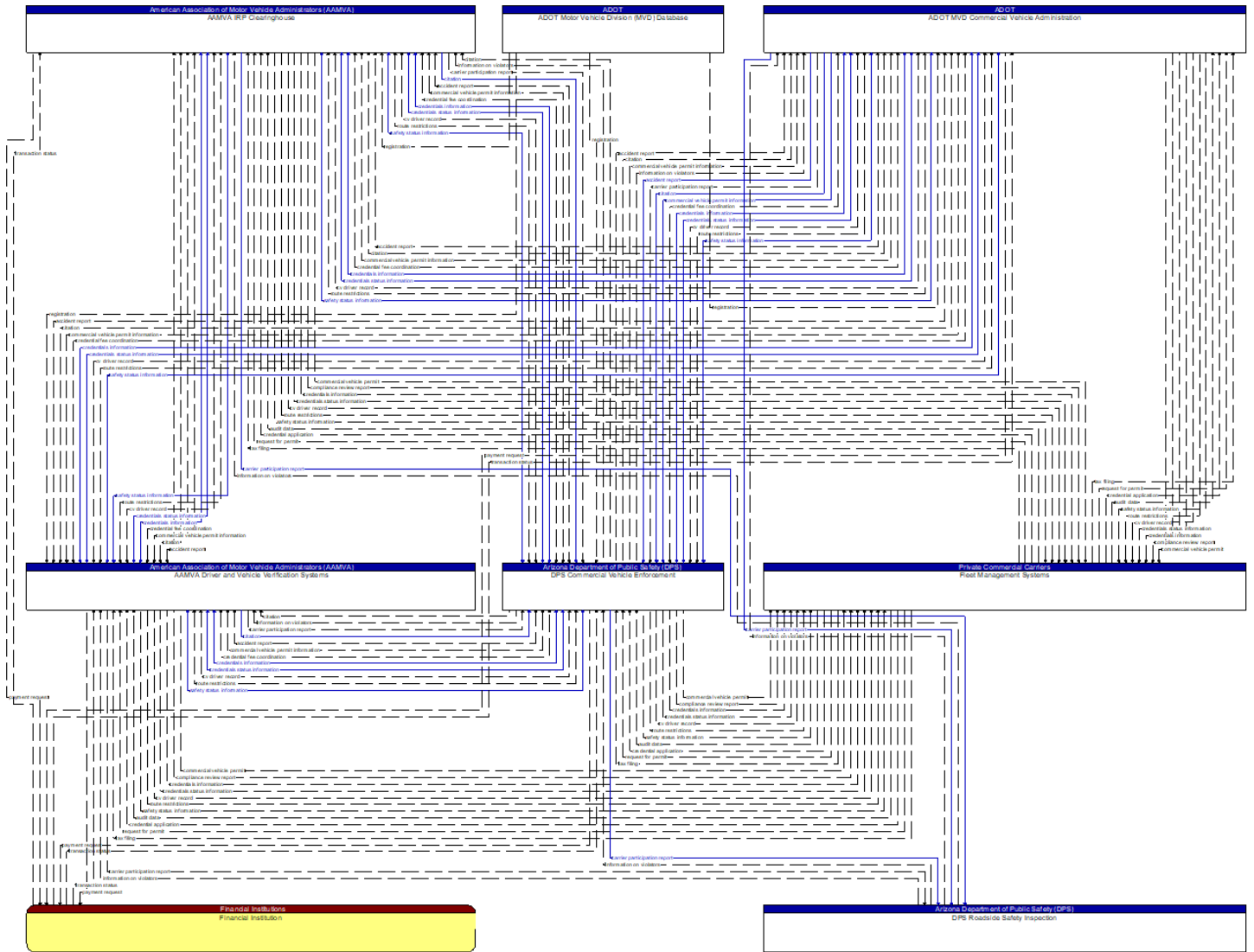

Legend:  
 - Blue line: Data flow  
 - Yellow box: Financial Institution

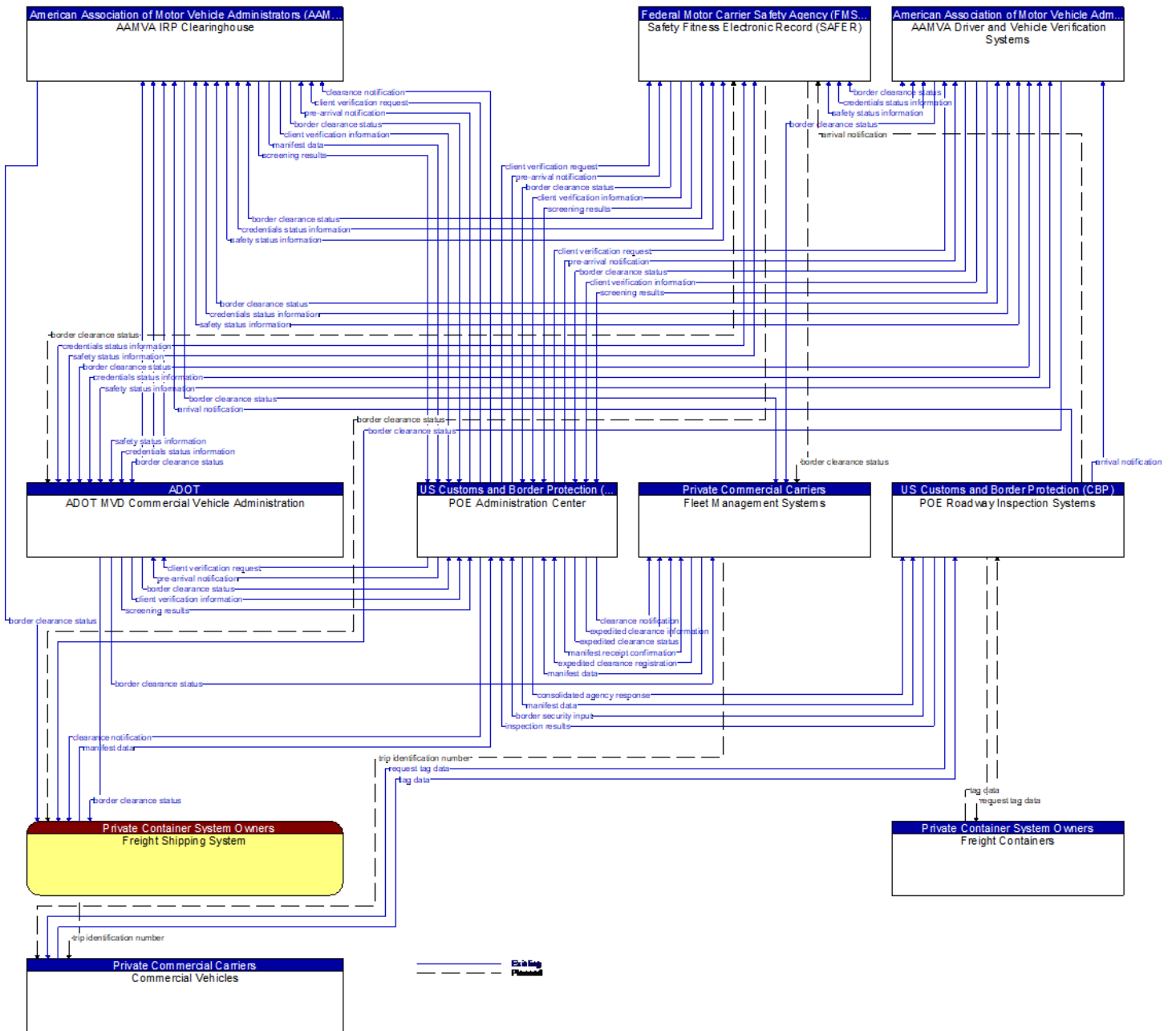

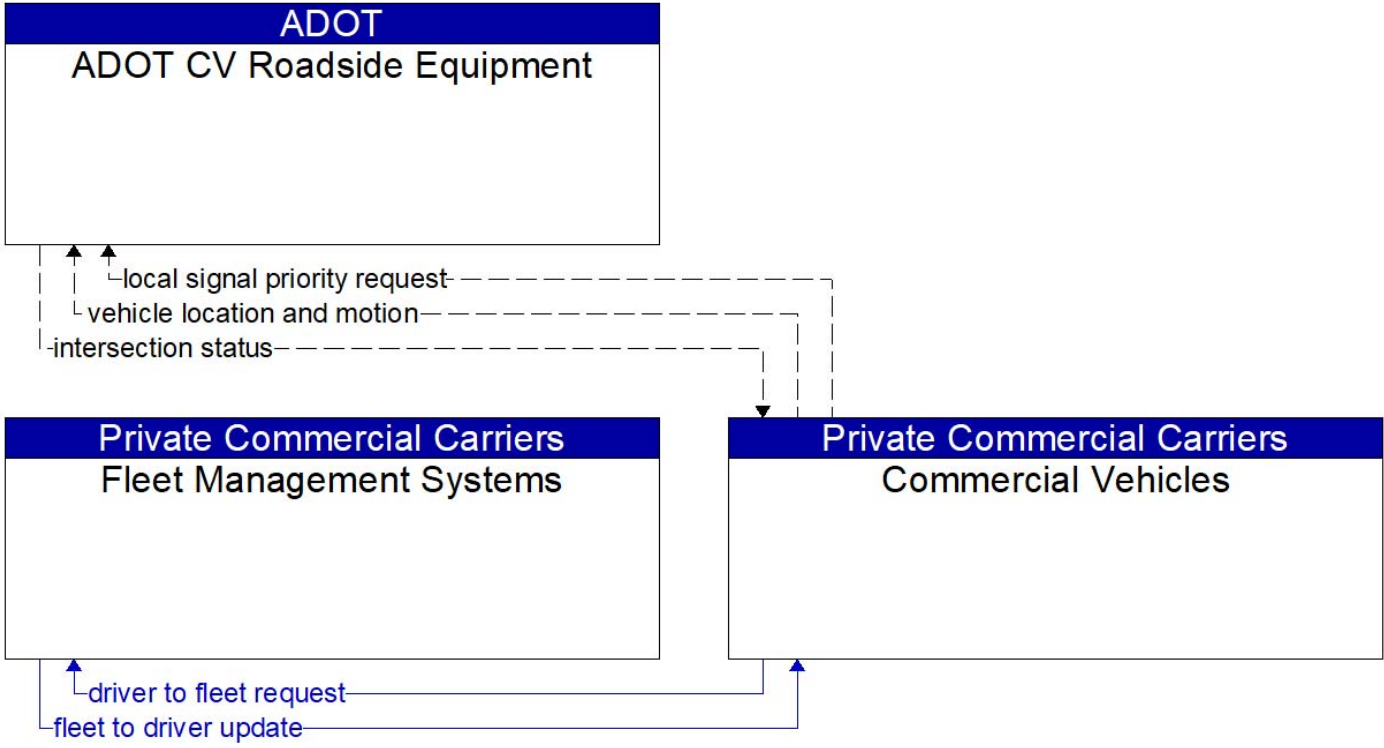

\_\_\_\_\_ Existing  
 - - - - - Planned



Federal Motor Carrier Safety Agency (FMSCA)  
Safety Fitness Electronic Record (SAFER)

Arizona Department of Public Safety (DPS)  
DPS Commercial Vehicle Enforcement

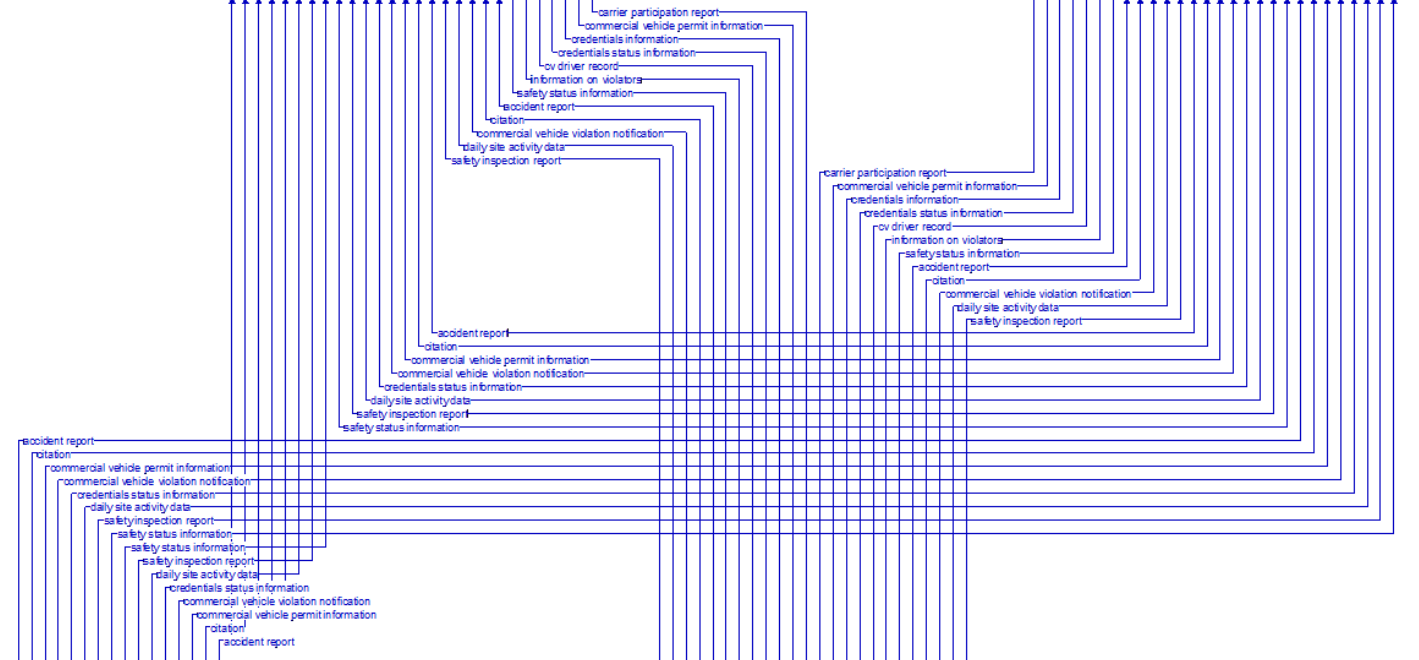

ADOT  
ADOT MVD Commercial Vehicle Administration

Arizona Department of Public Safety (DPS)  
DPS Roadside Safety Inspection

Private Commercial Carriers  
Commercial Vehicles

Private Commercial Carriers  
Driver Identification Card

Existing  
Planned



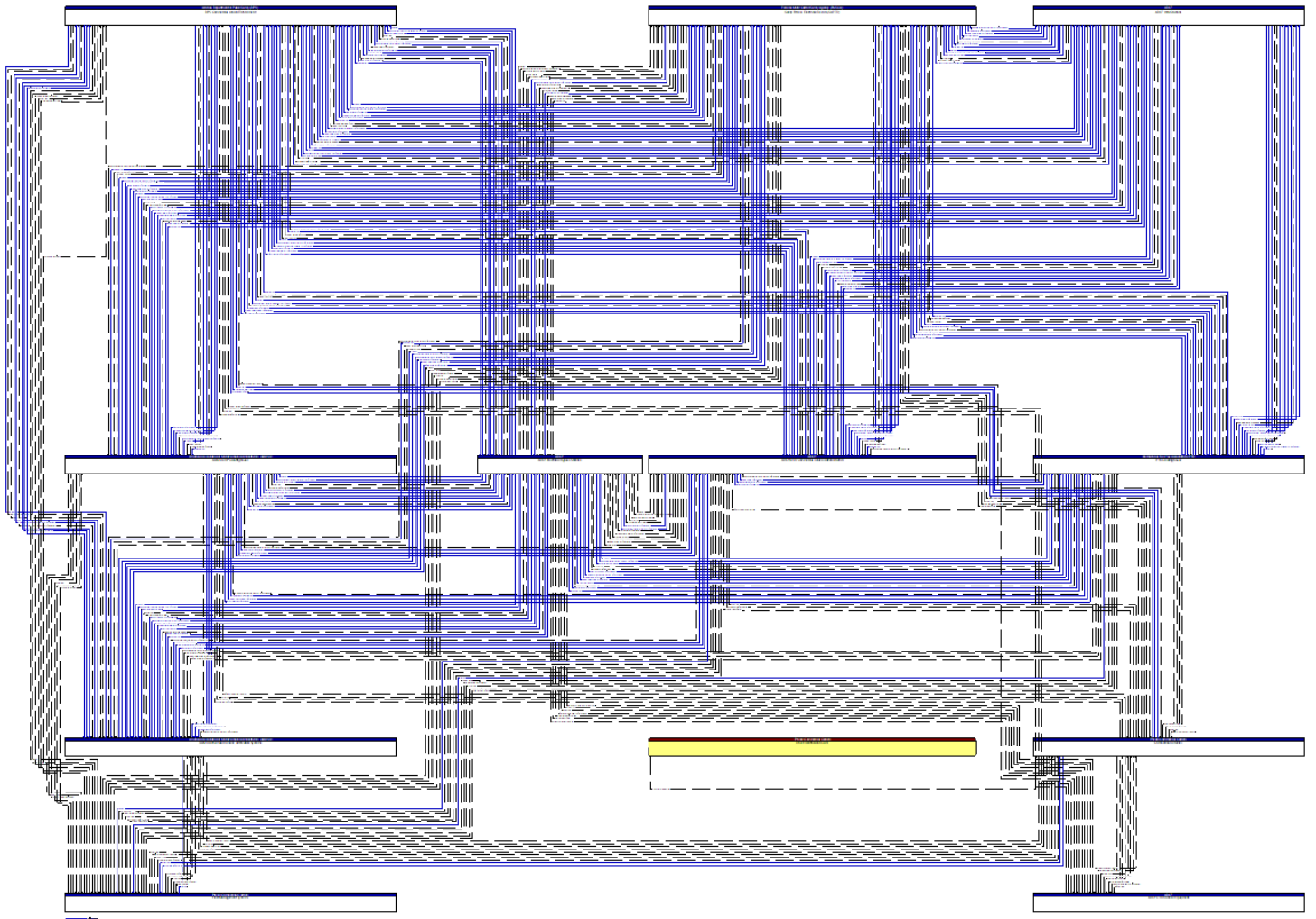

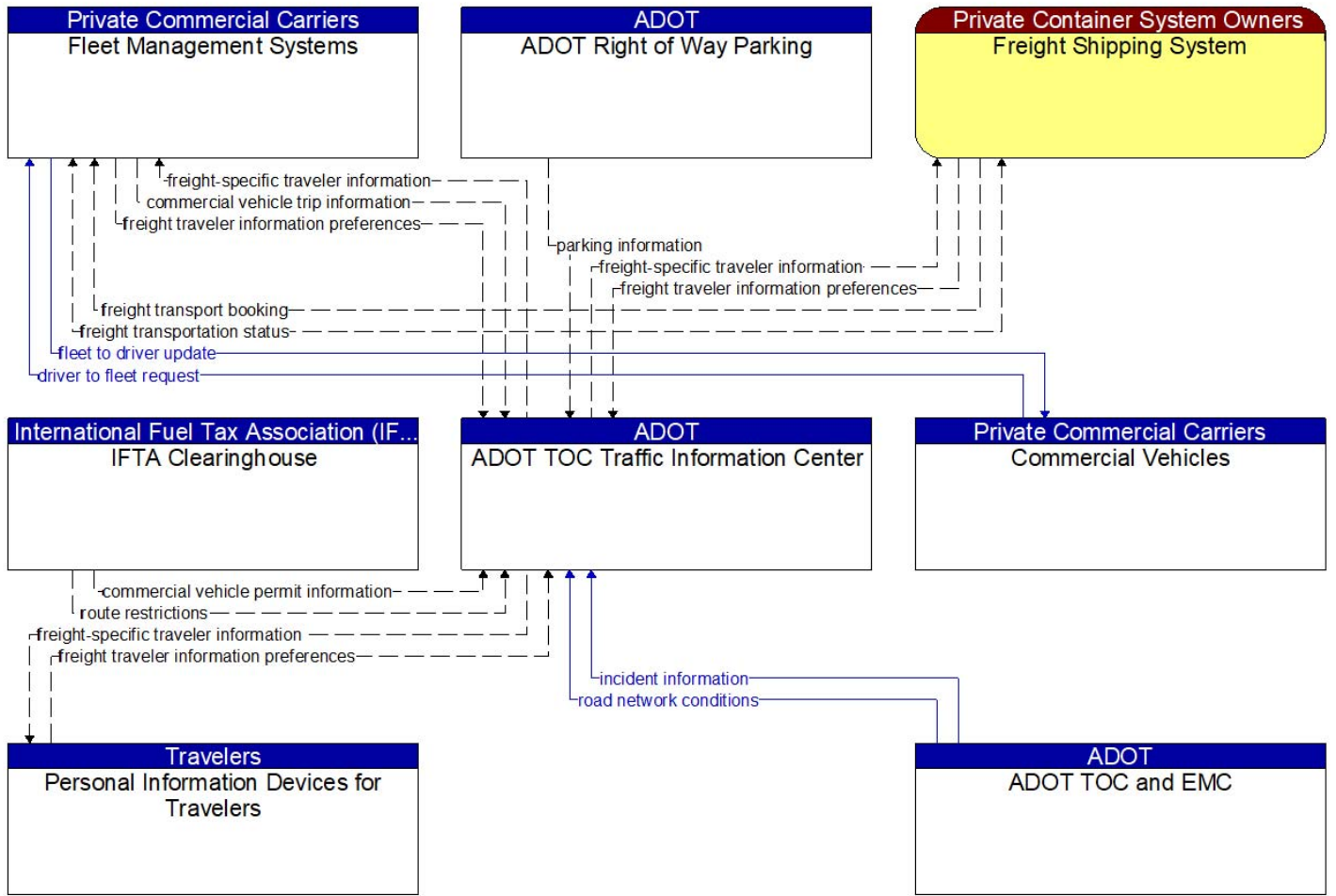

— Existing  
 - - - Planned

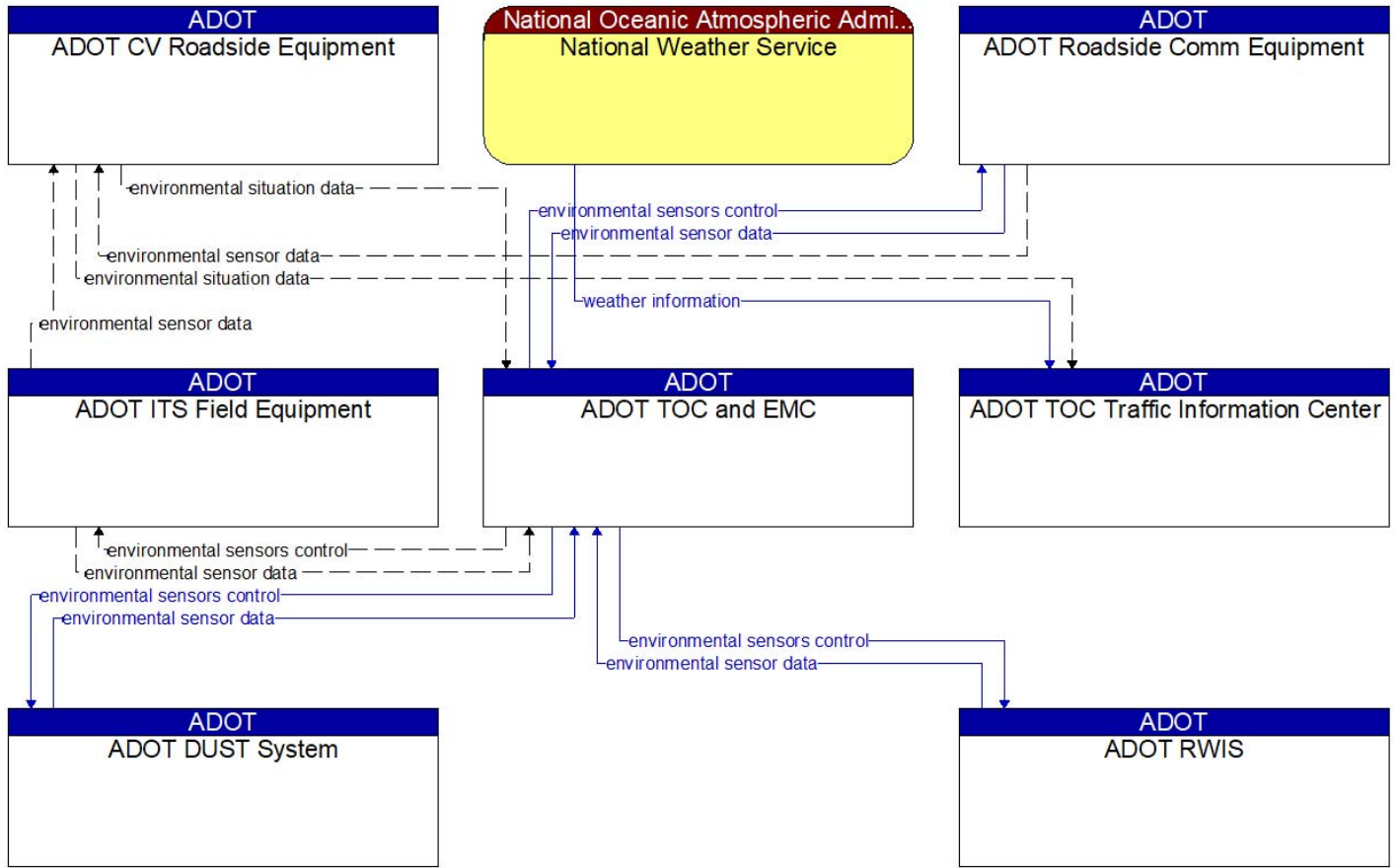

— Existing  
 - - - Planned

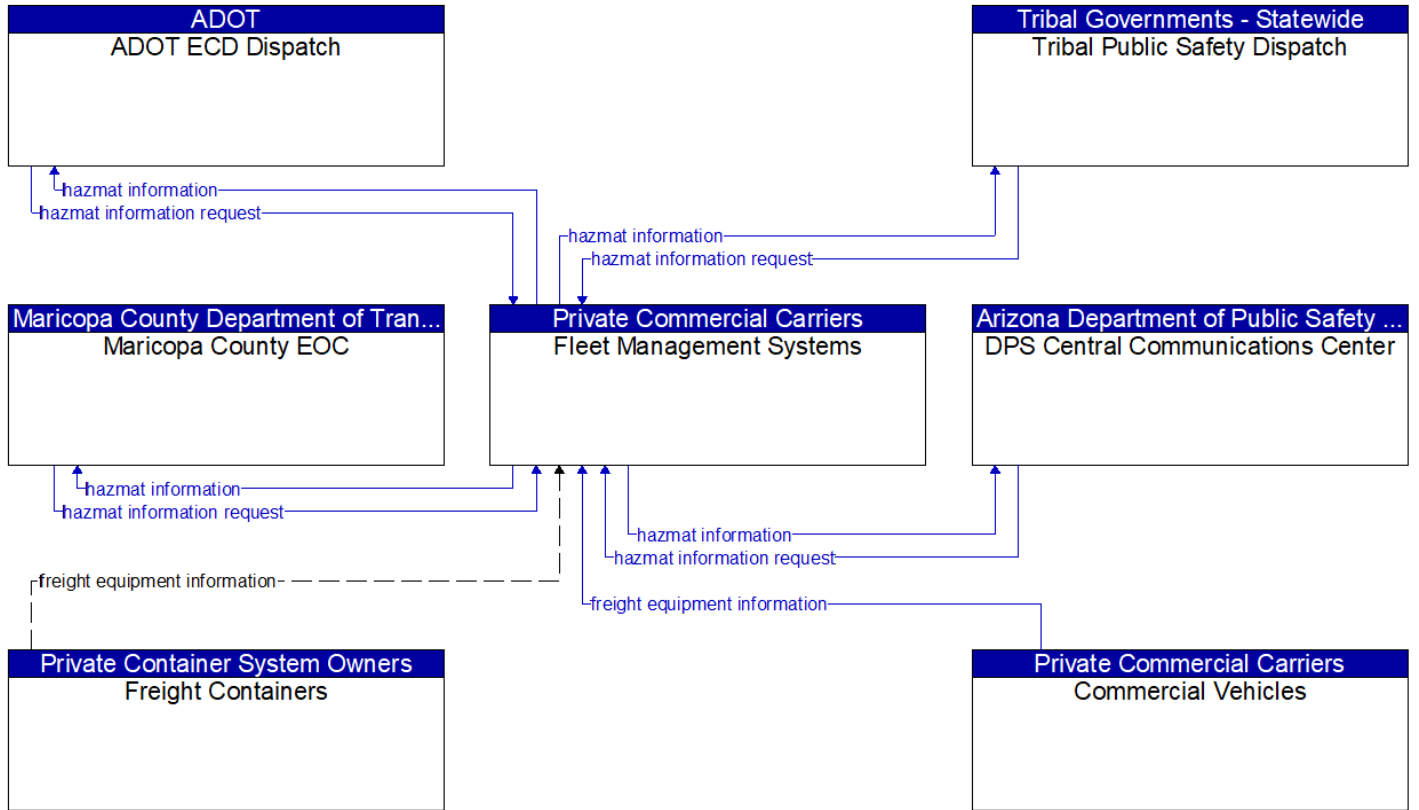

— Existing  
 - - - Planned

Arizona Division of Emergency and M...  
DEMA CRT - HazMat Response Team

commercial vehicle incident notification

ADOT  
ADOT MVD Commercial Vehicle  
Administration

ADOT  
ADOT Electronic Bypass Stations

credentials information

----- Planned

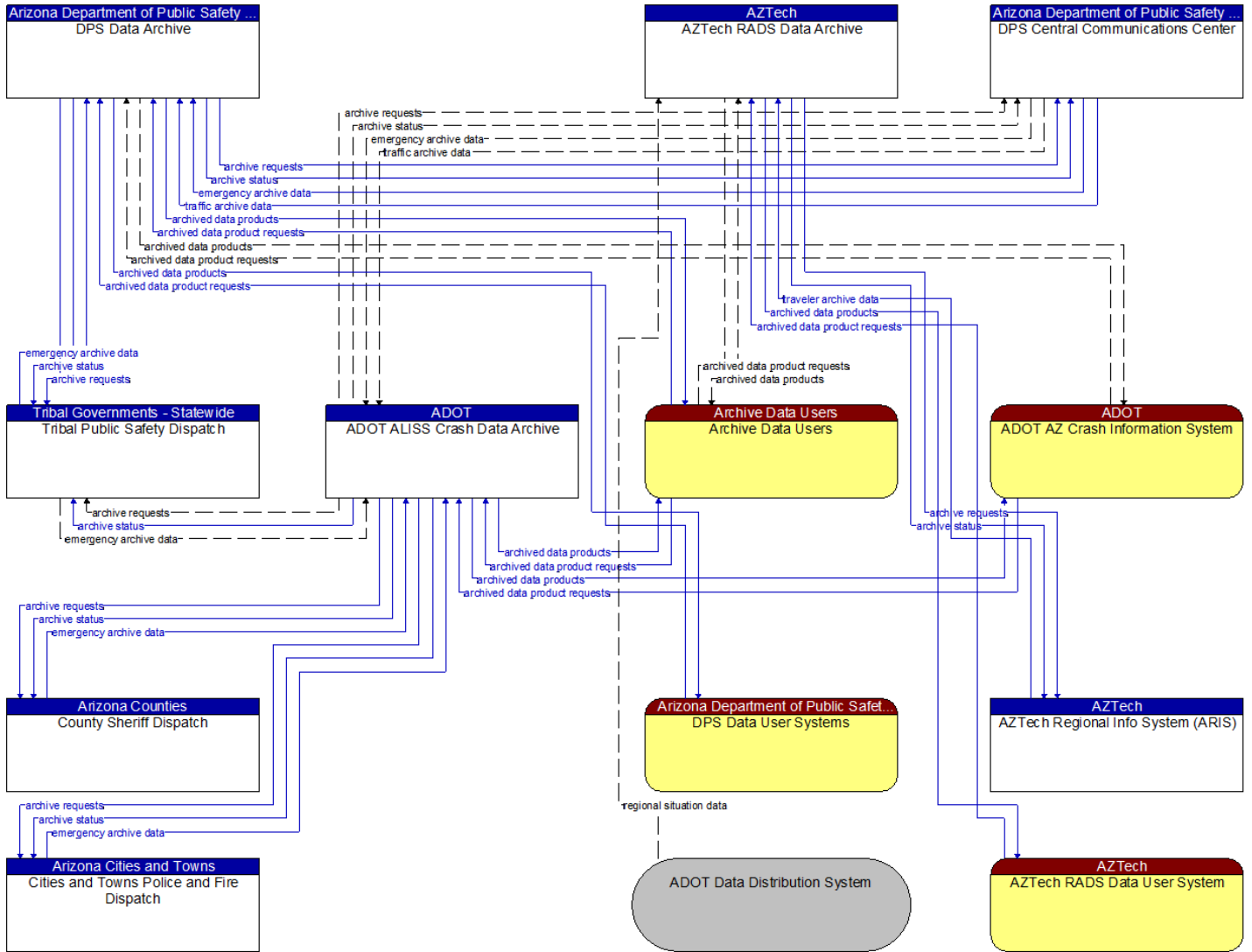

— Existing  
 - - - Planned



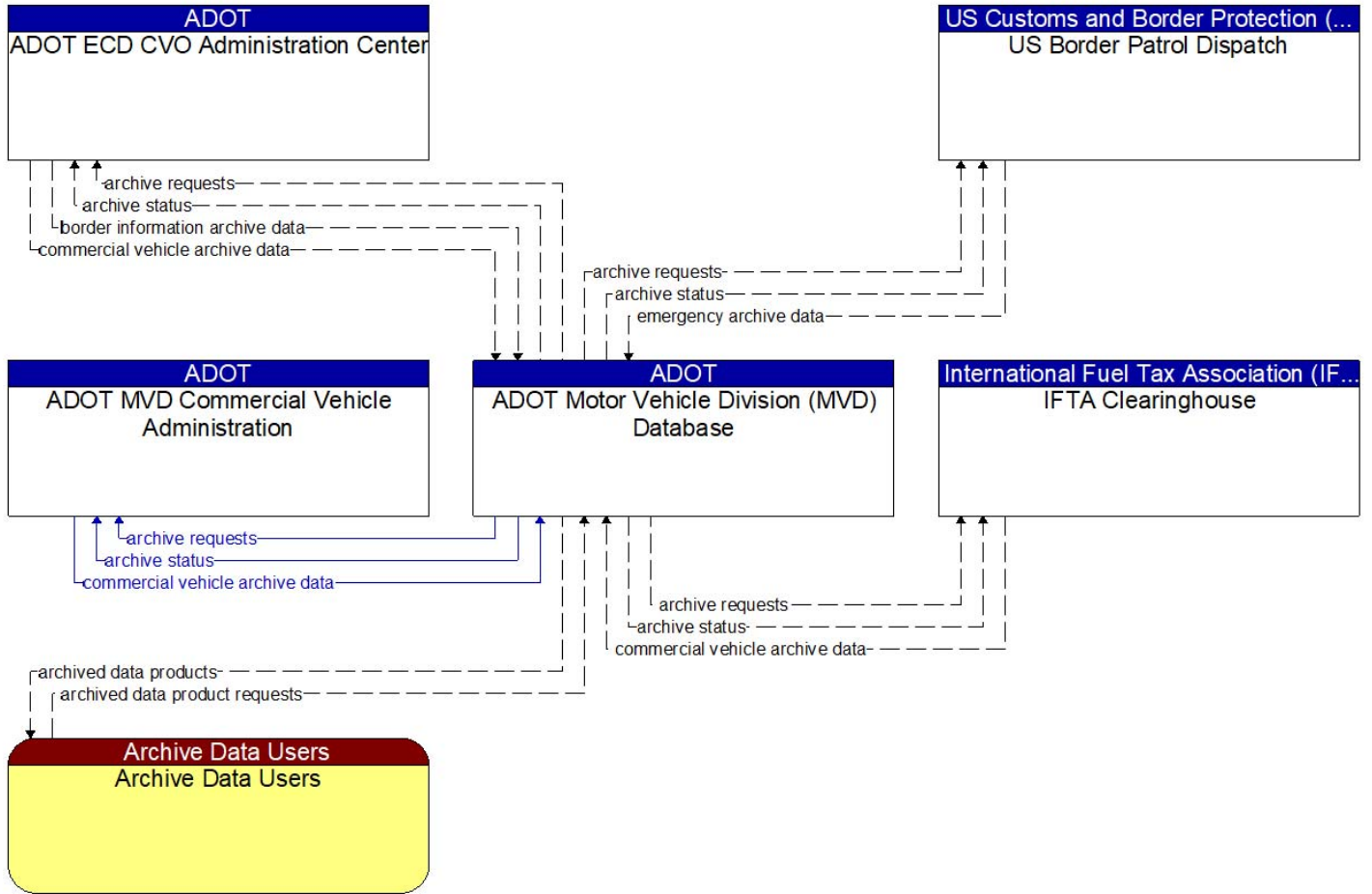

————— Existing  
 - - - - - Planned



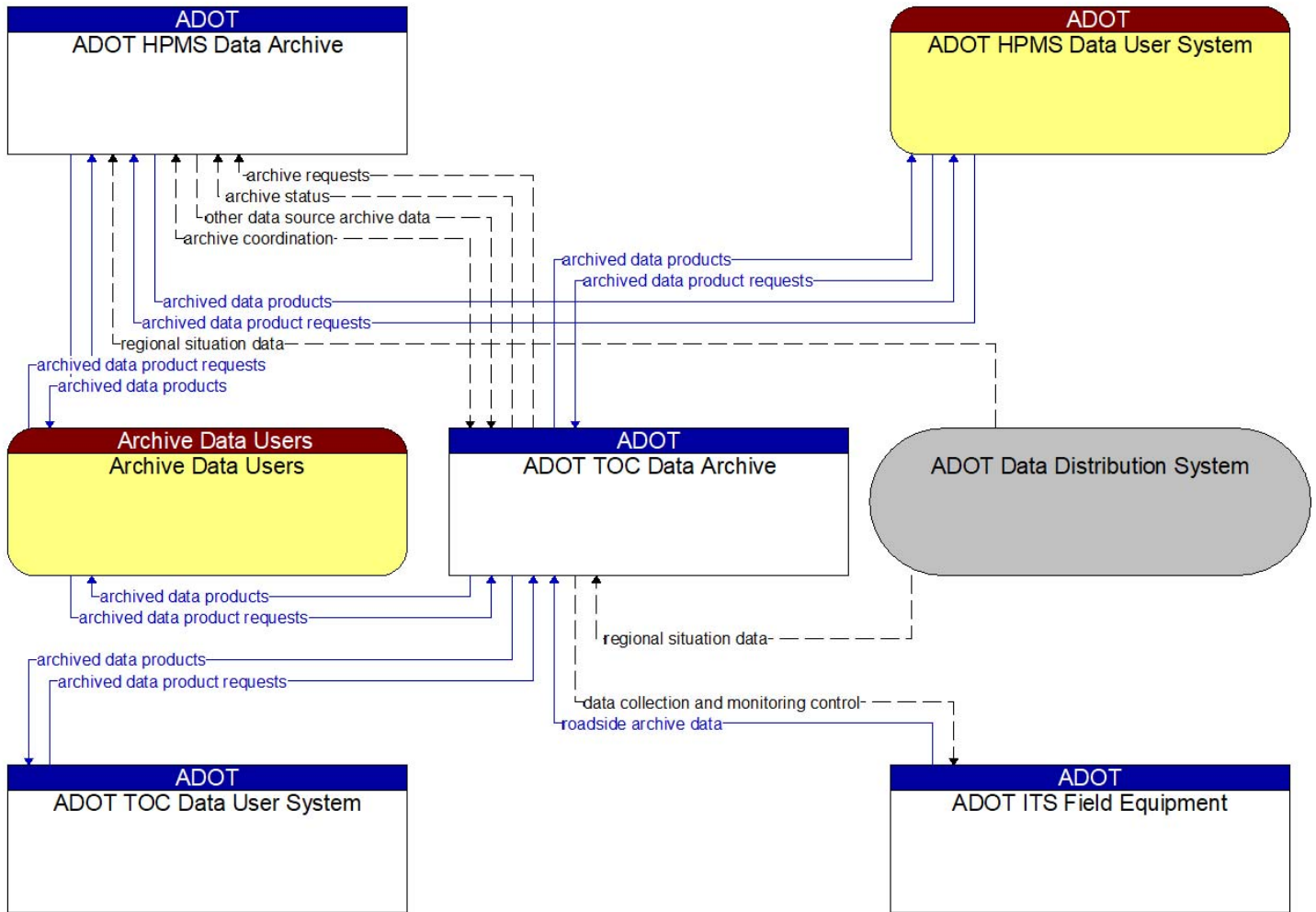

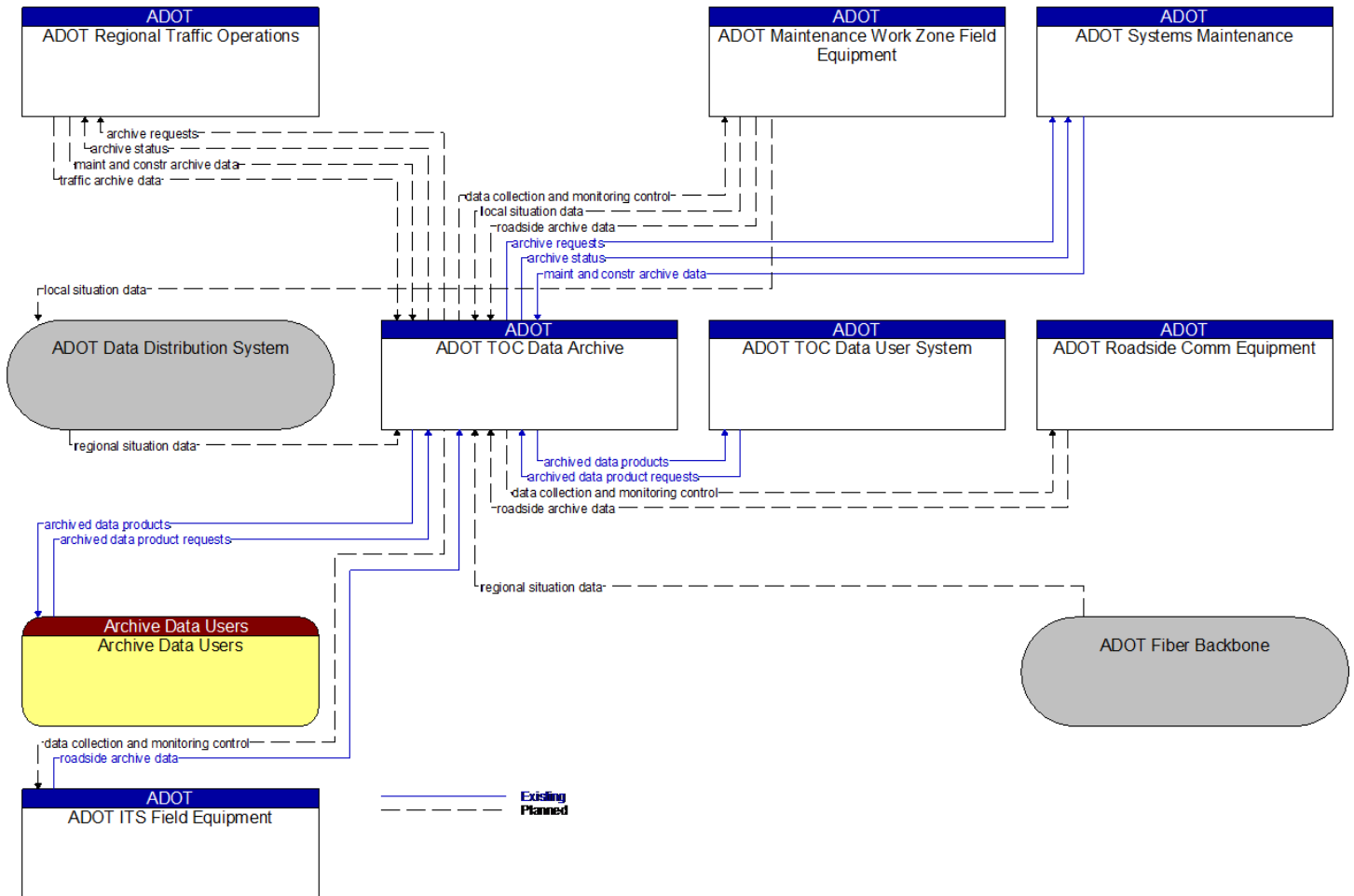



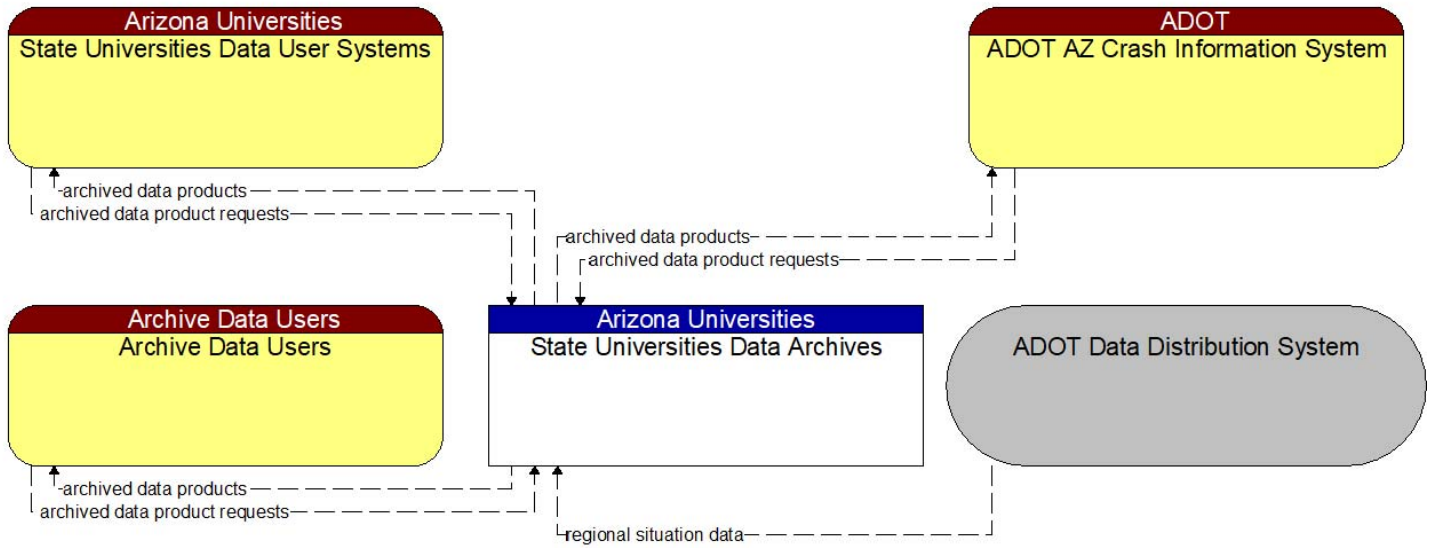

----- **Planned**

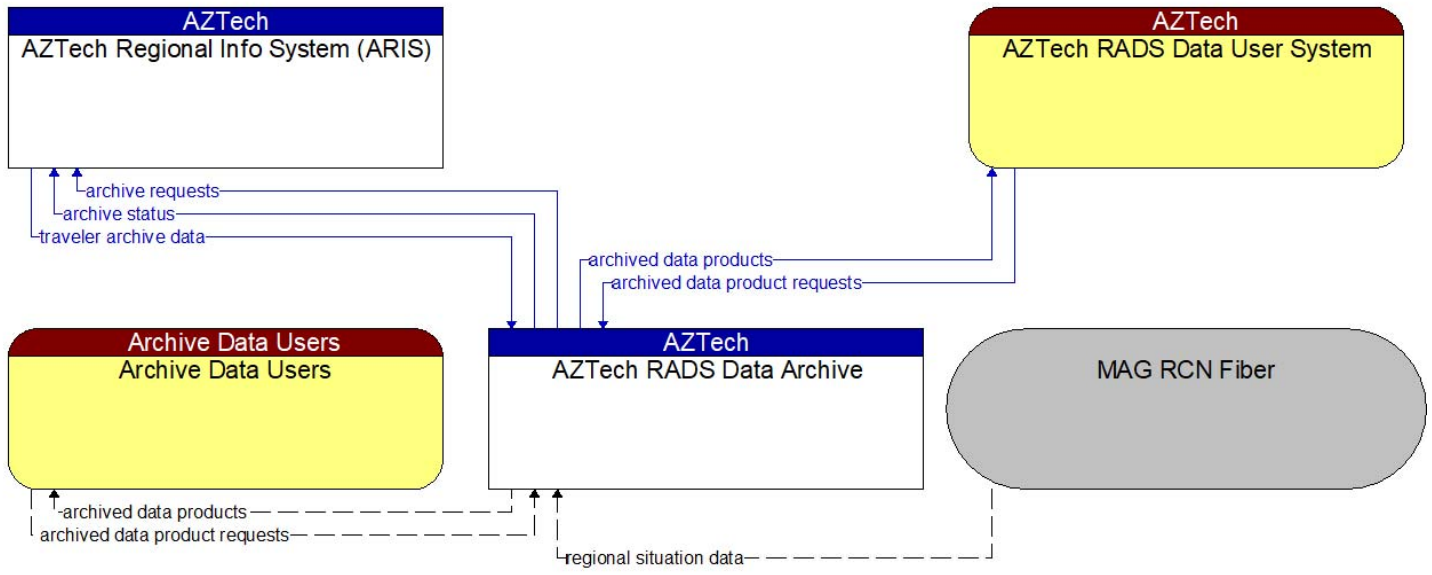

\_\_\_\_\_ Existing  
 - - - - - Planned





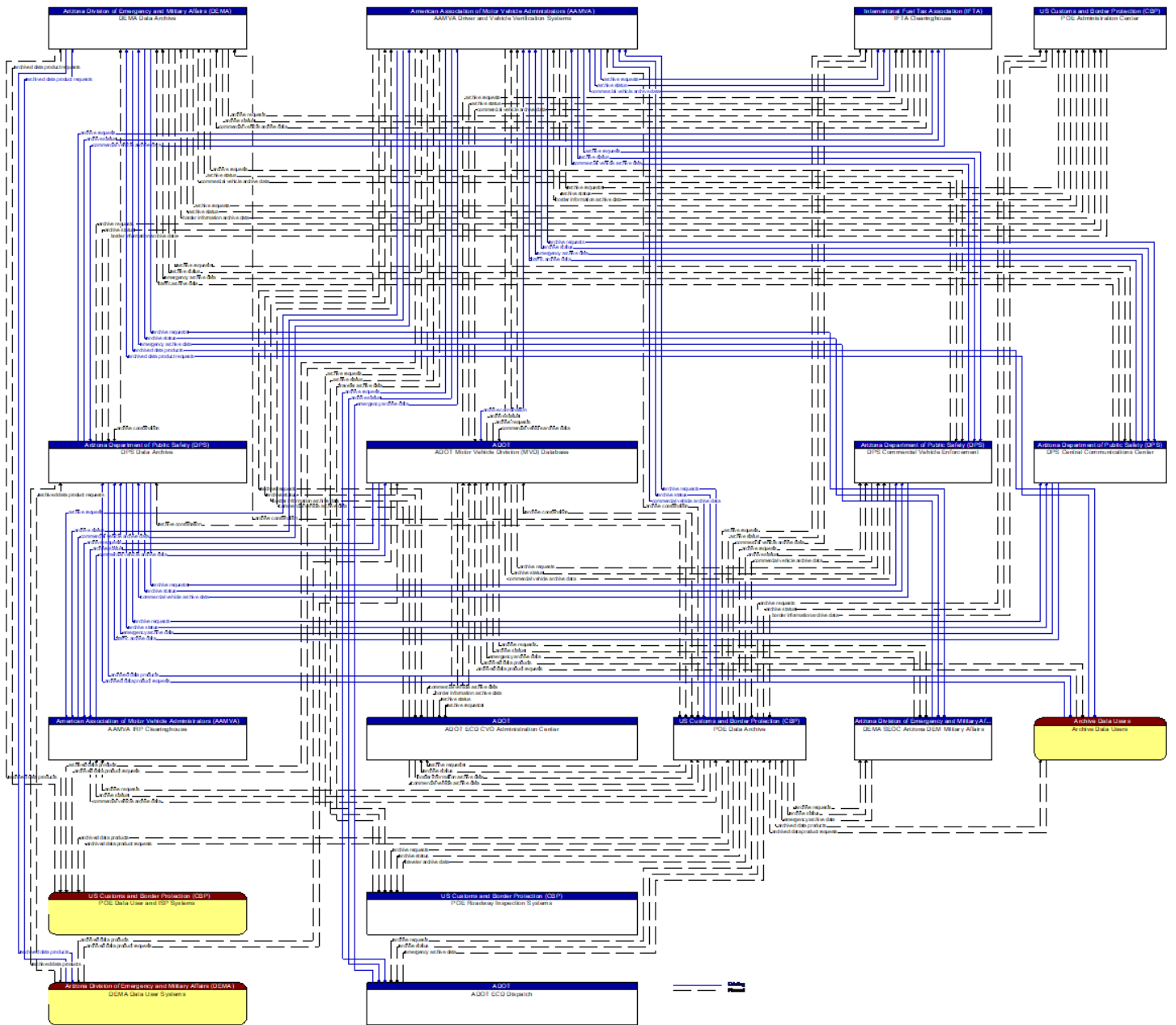

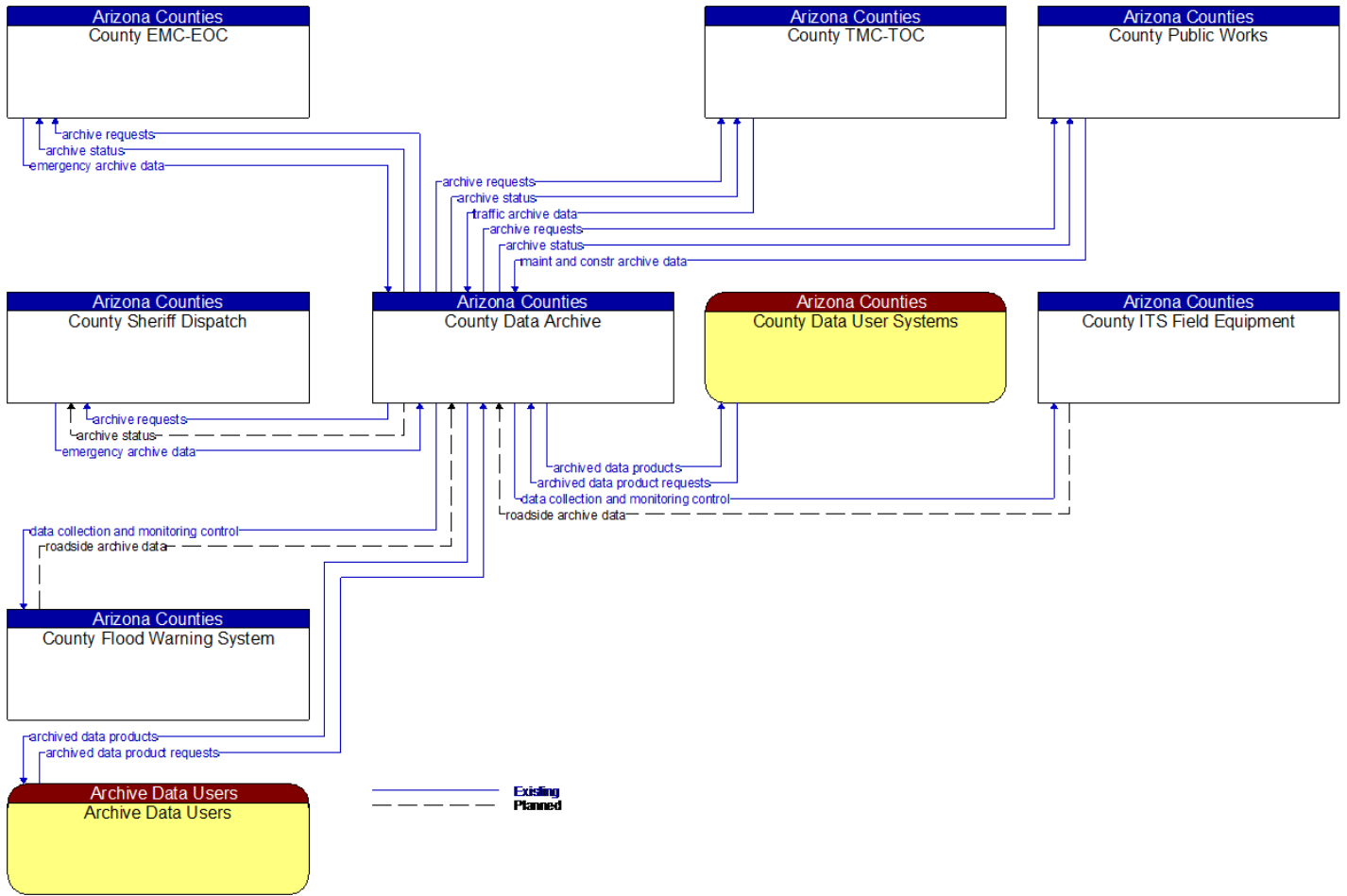

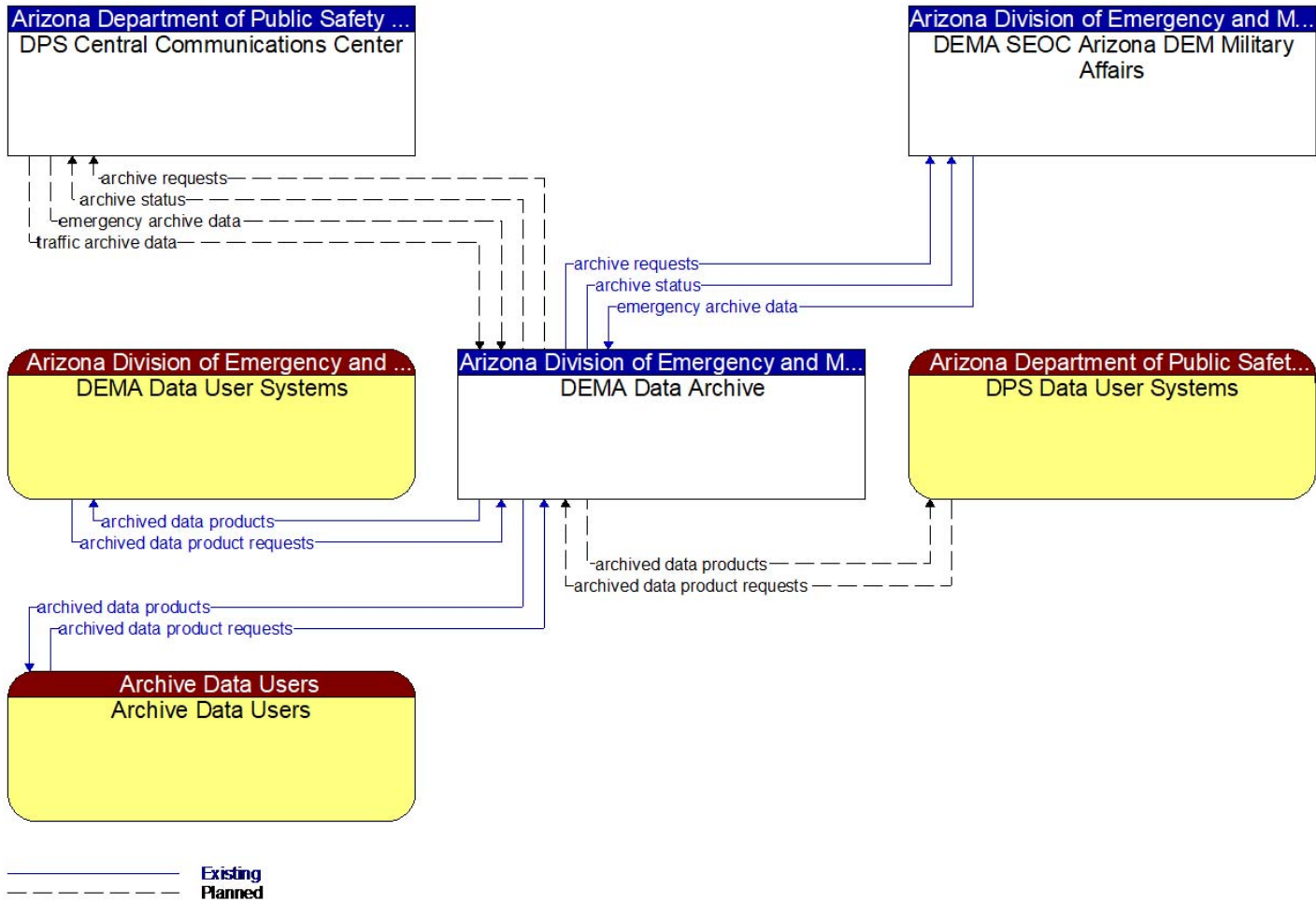

↑ archive requests  
 ↑ archive status  
 ↓ emergency archive data  
 ↓ traffic archive data

↑ archive requests  
 ↑ archive status  
 ↓ emergency archive data

↑ archived data products  
 ↓ archived data product requests

↑ archived data products  
 ↓ archived data product requests

↑ archived data products  
 ↓ archived data product requests

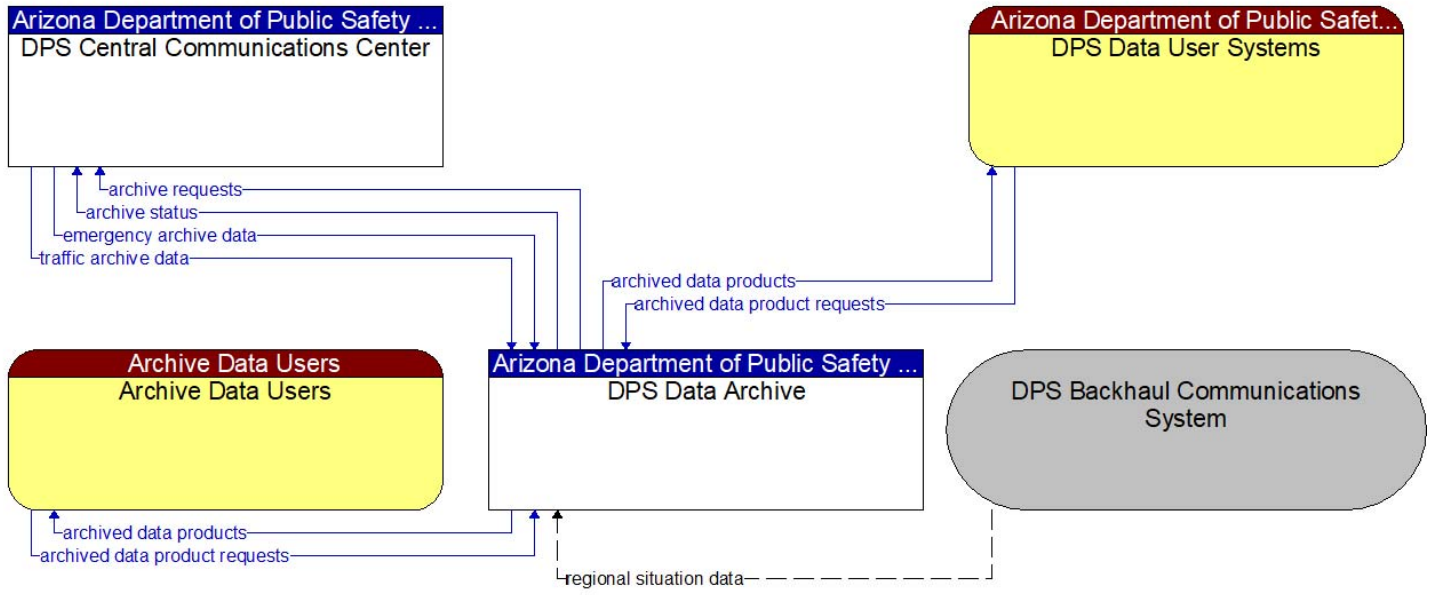

————— Existing  
 - - - - - Planned

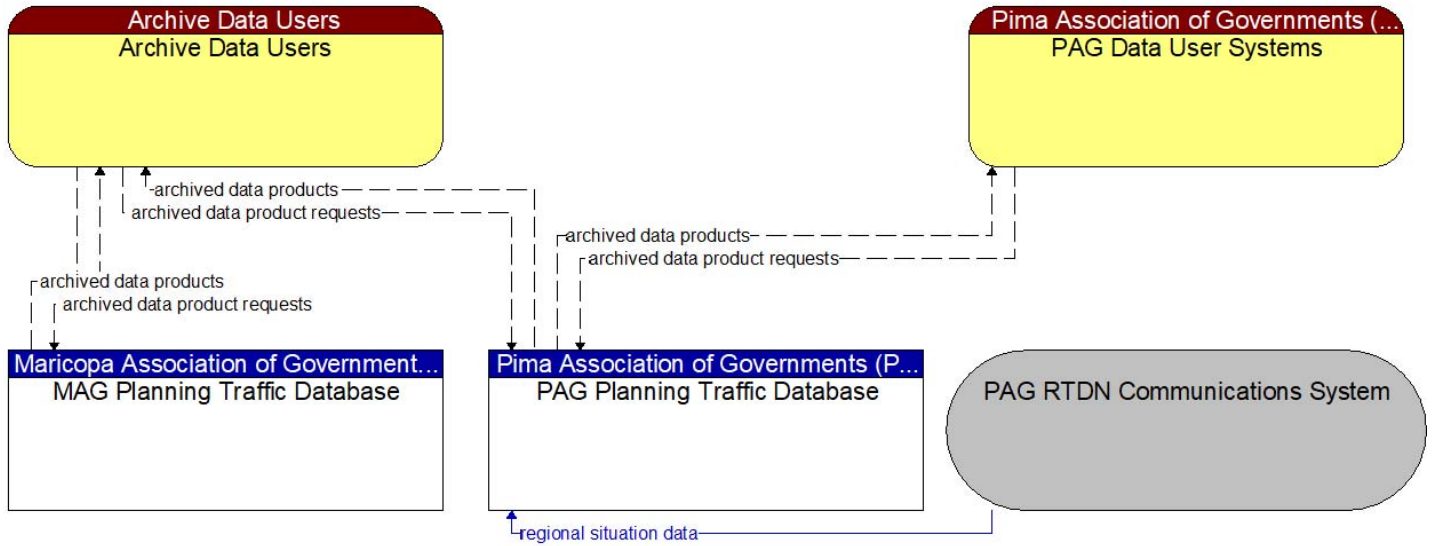

\_\_\_\_\_ Existing  
 - - - - - Planned

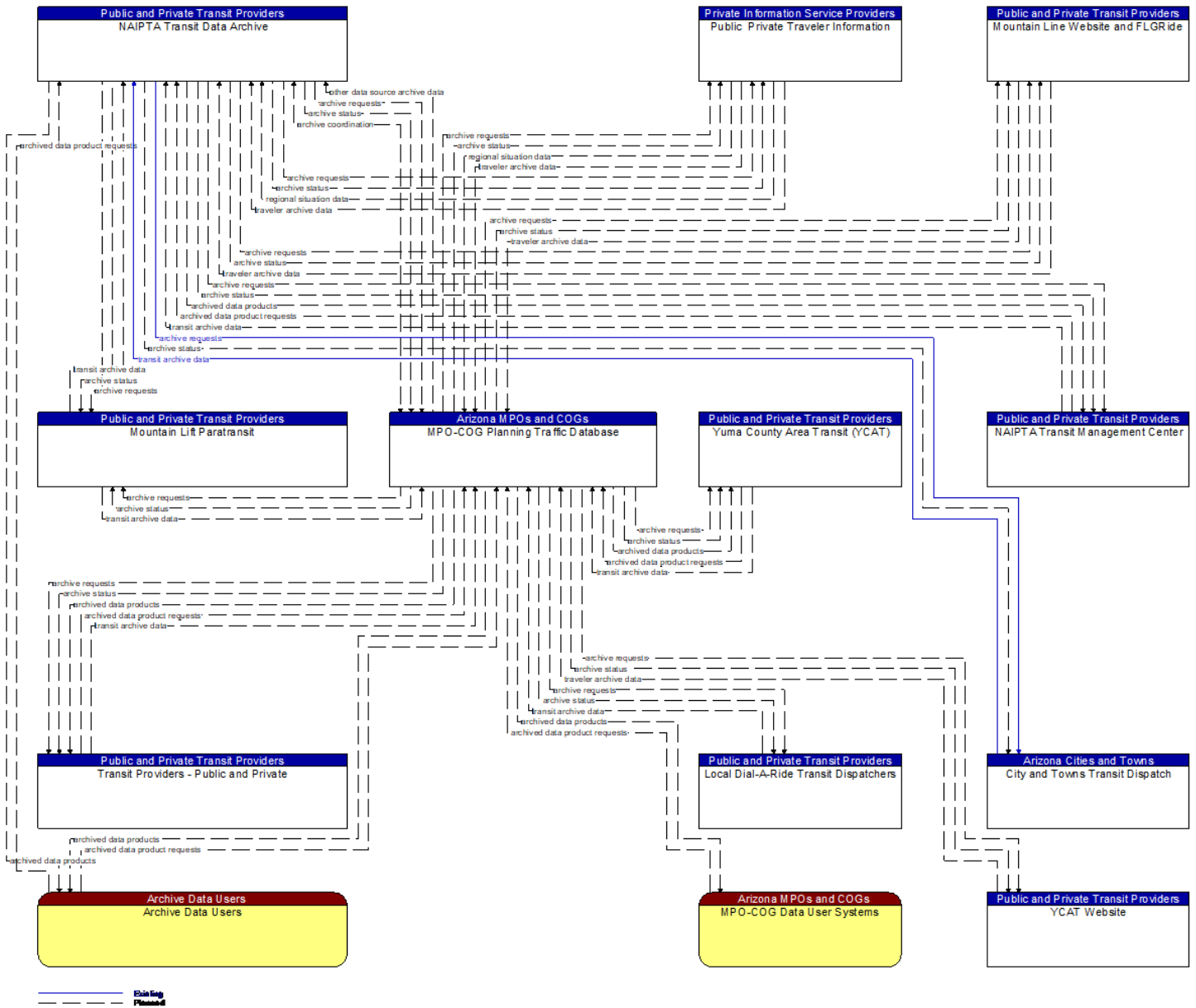

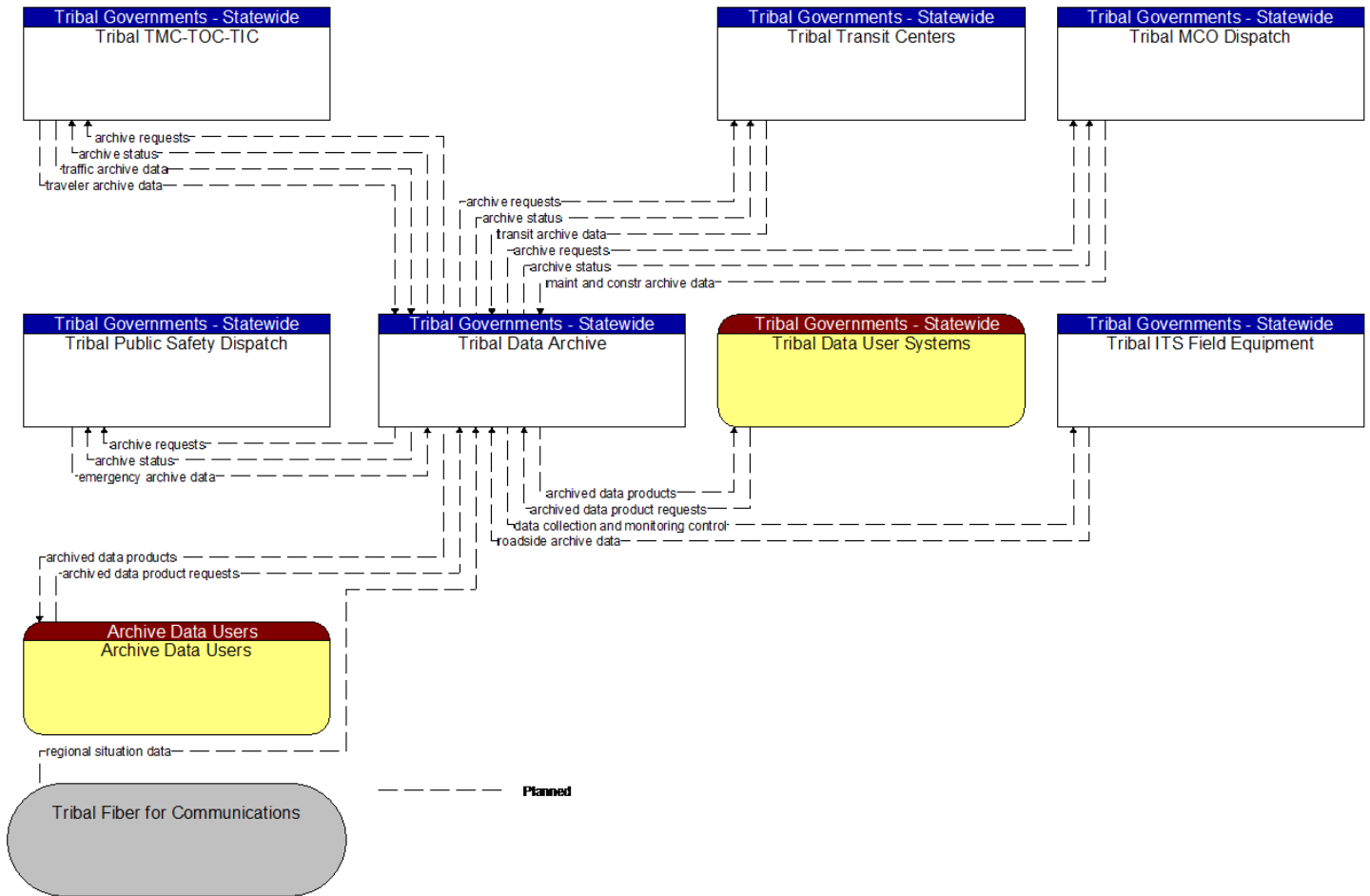

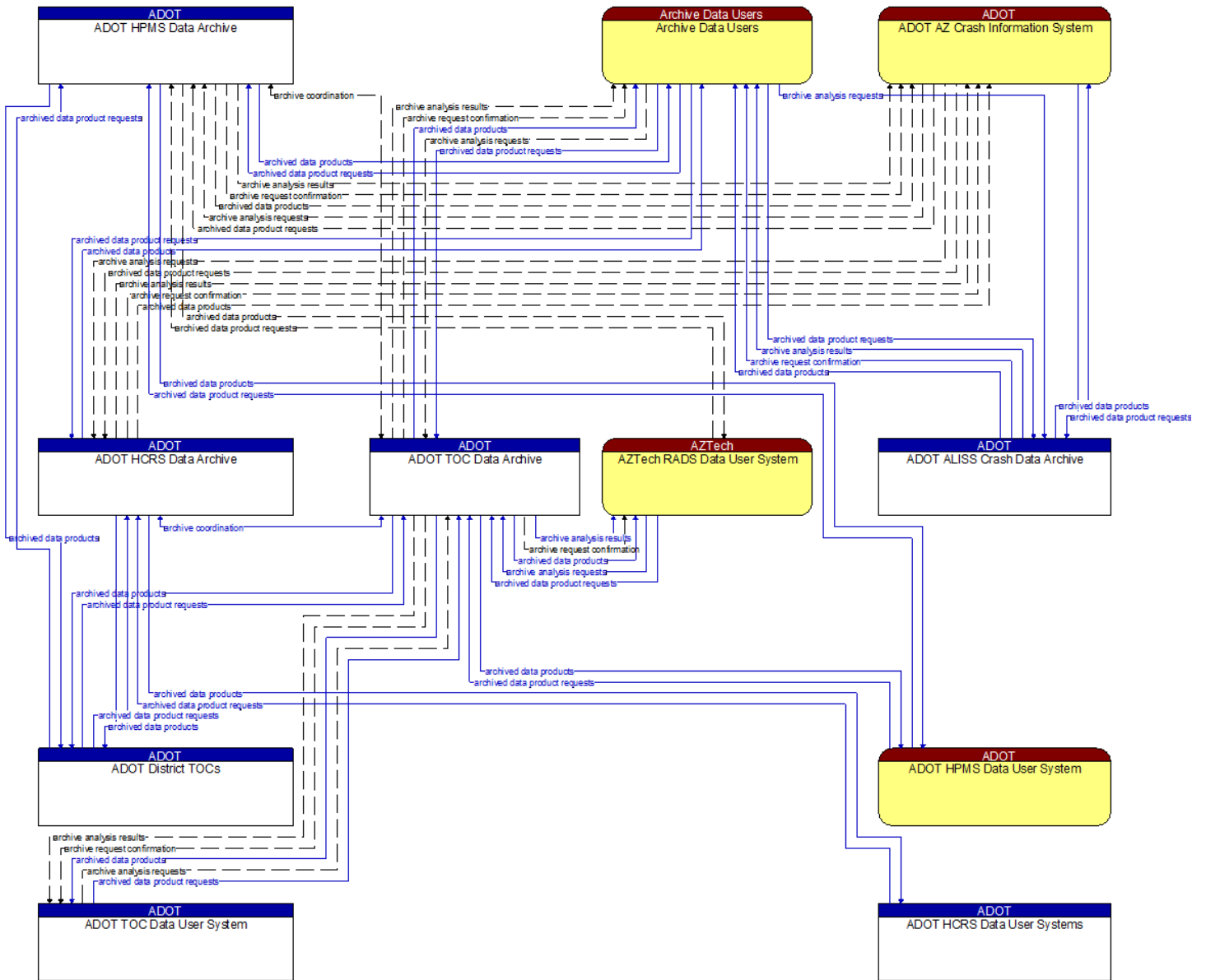

— Existing  
 - - - Planned





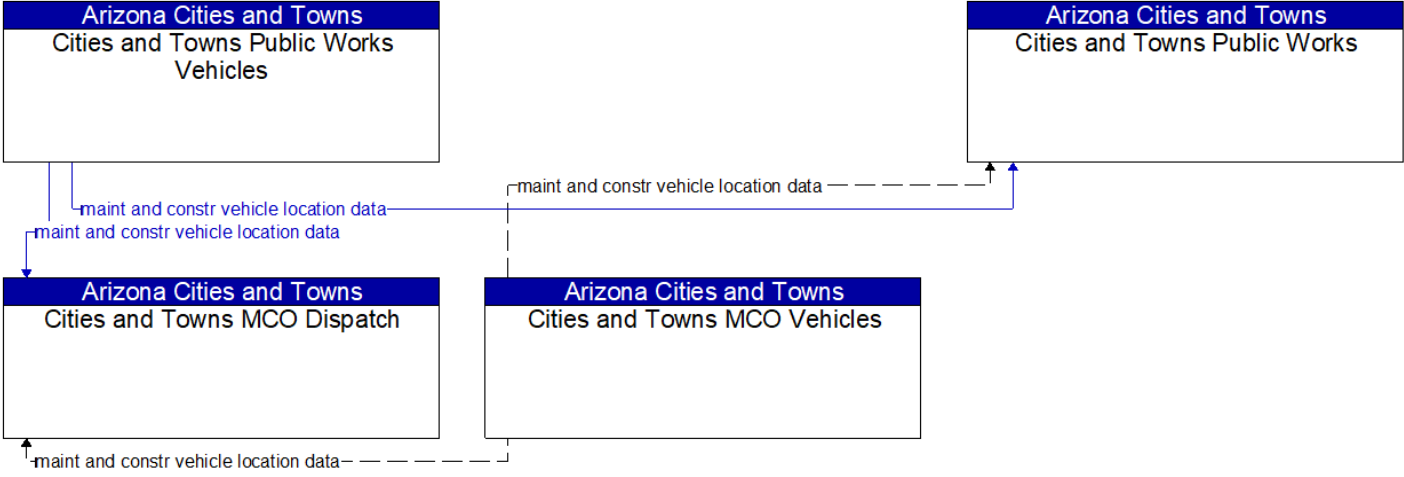

———— Existing  
- - - - - Planned

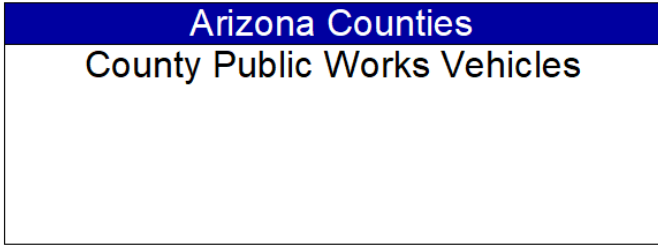
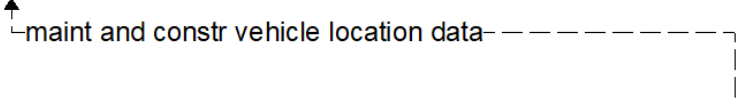
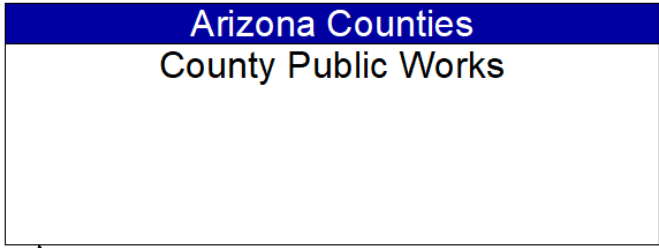

----- **Planned**

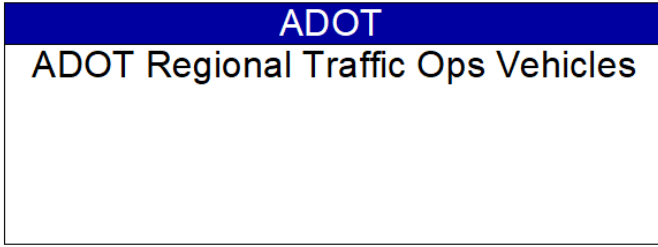
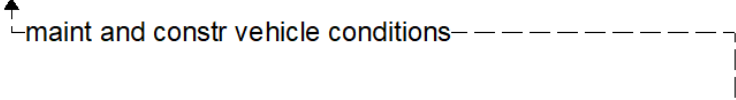
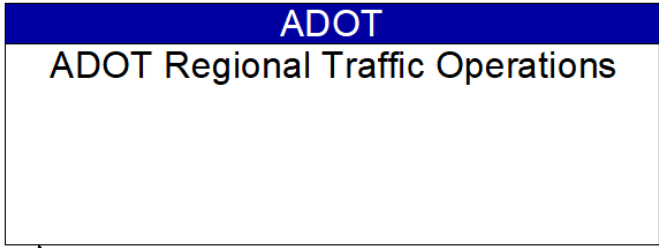

----- **Planned**



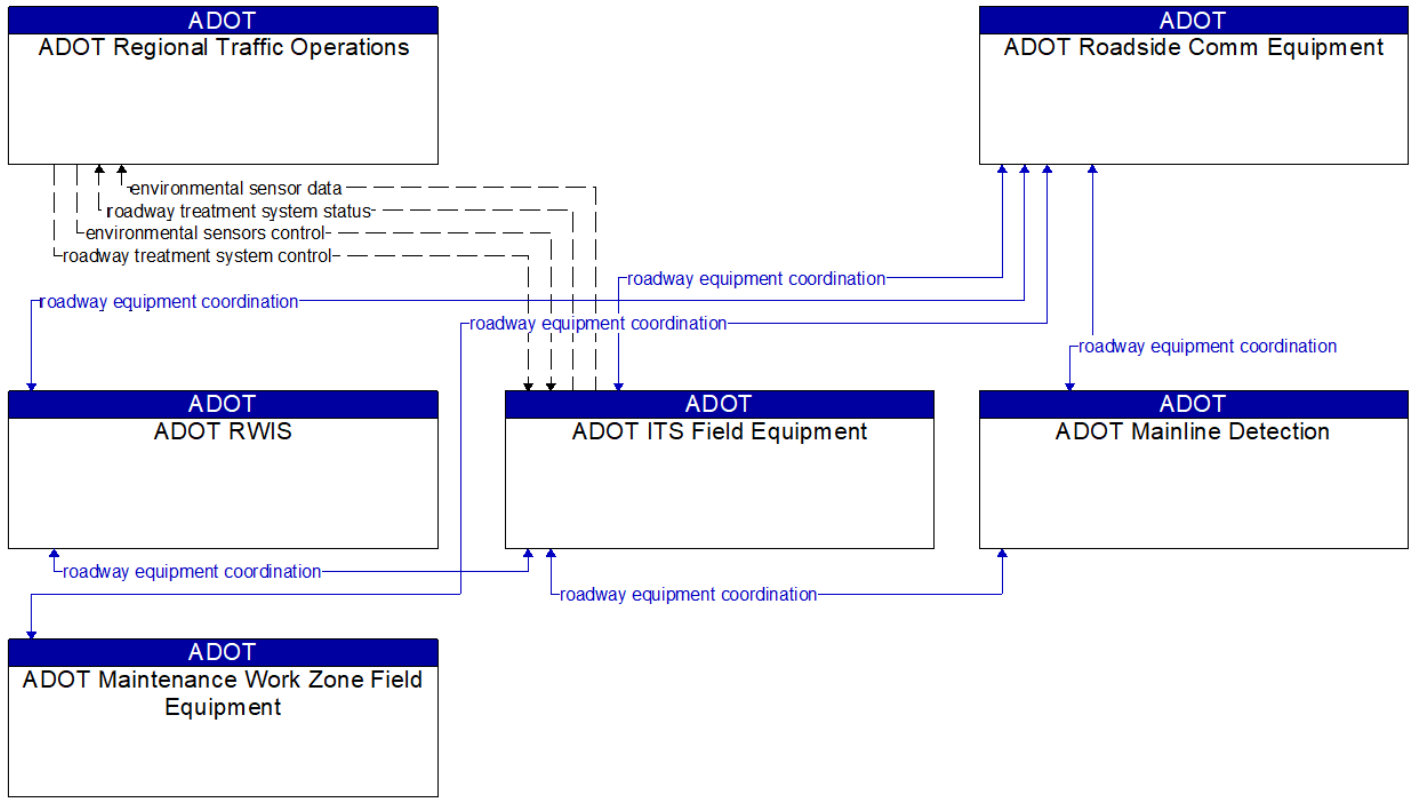

——— Existing  
 - - - - - Planned

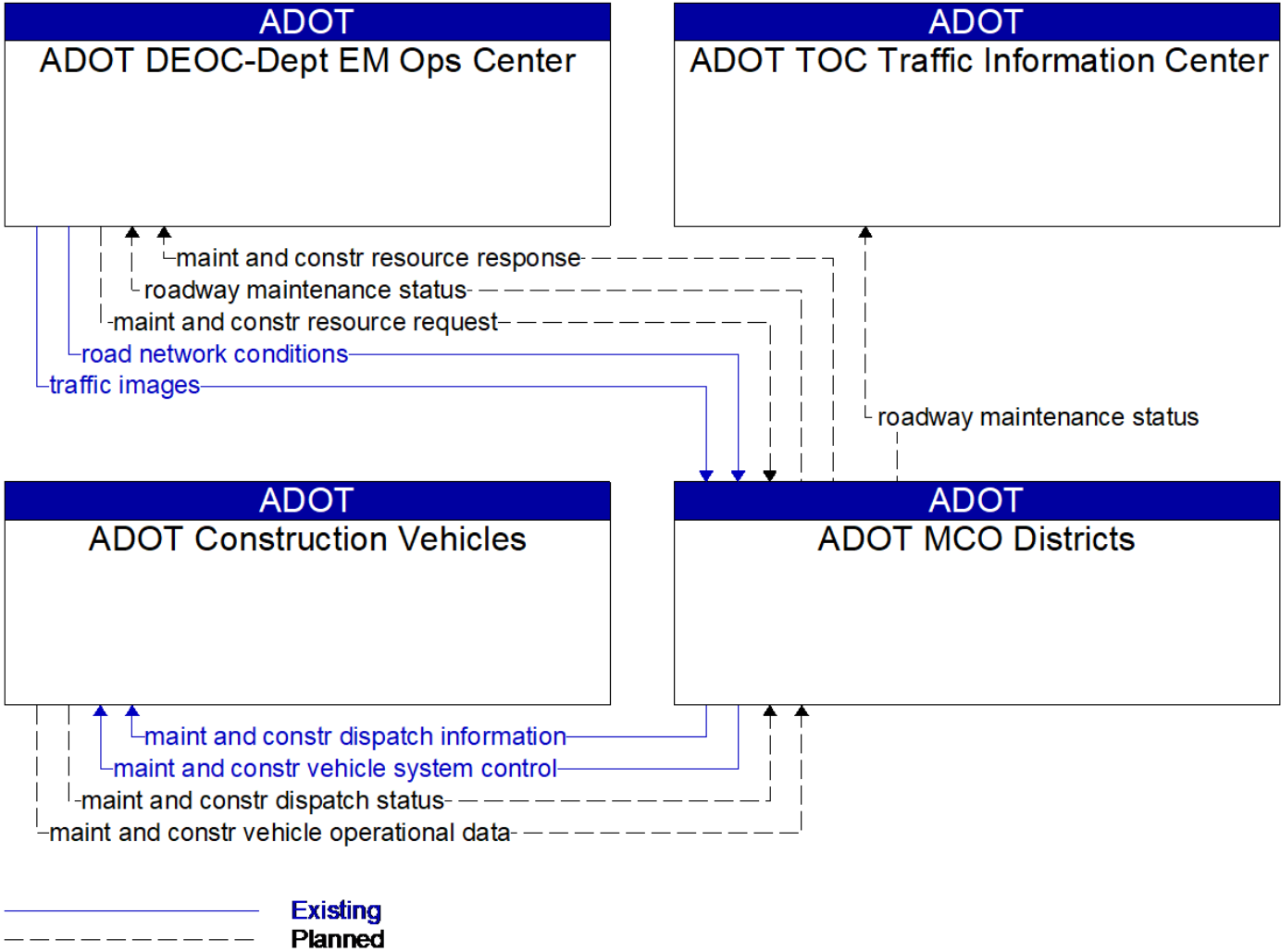

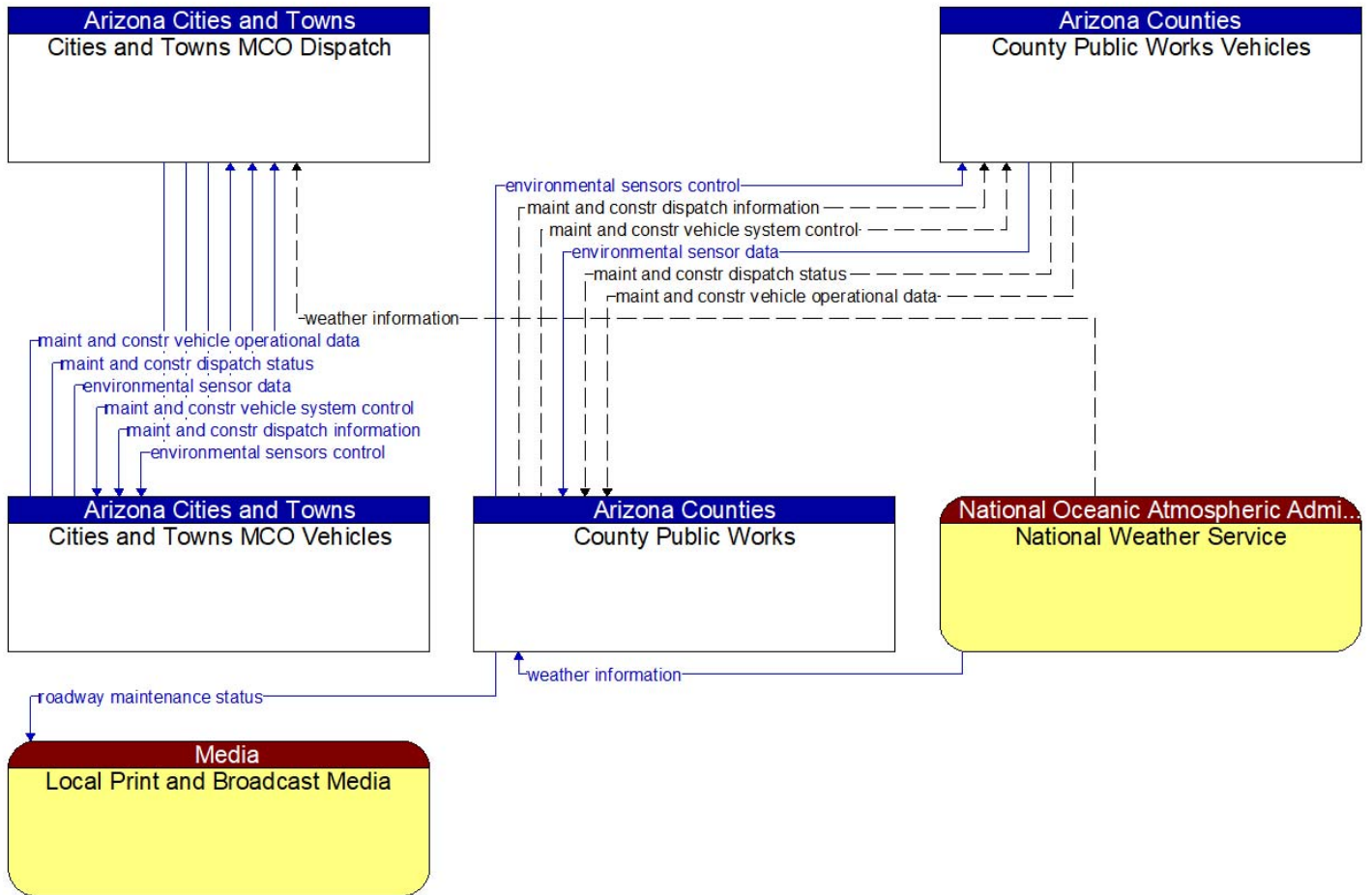

\_\_\_\_\_ Existing  
 - - - - - Planned



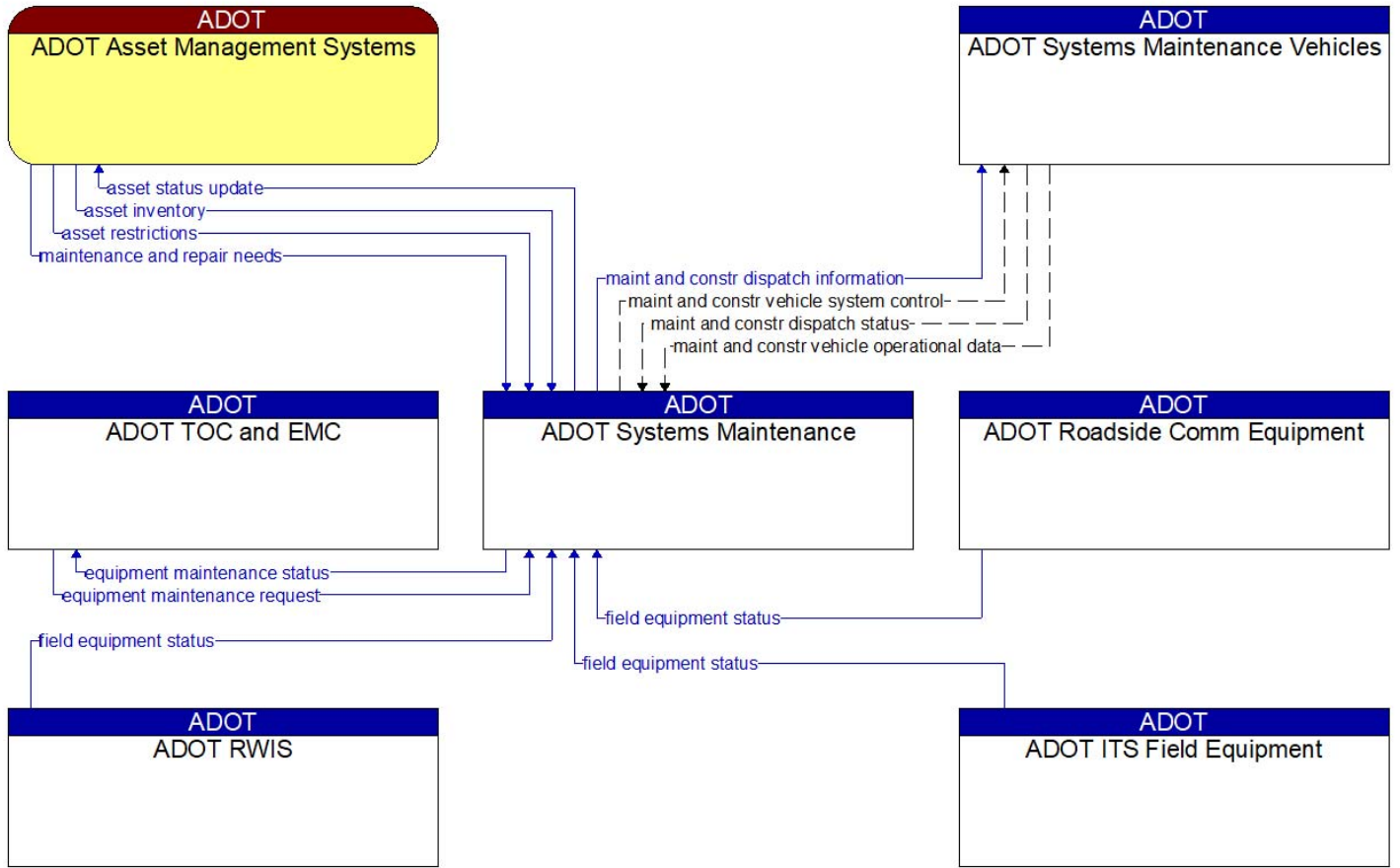

————— Existing  
 - - - - - Planned

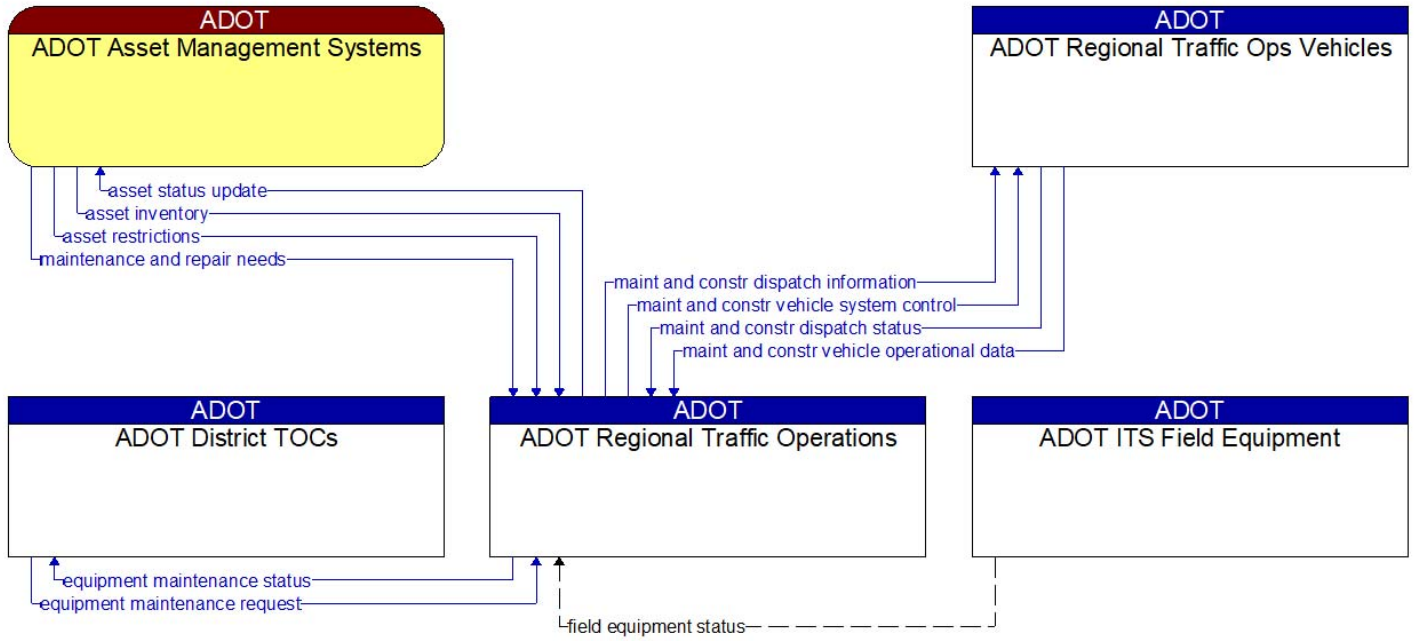

————— Existing  
 - - - - - Planned

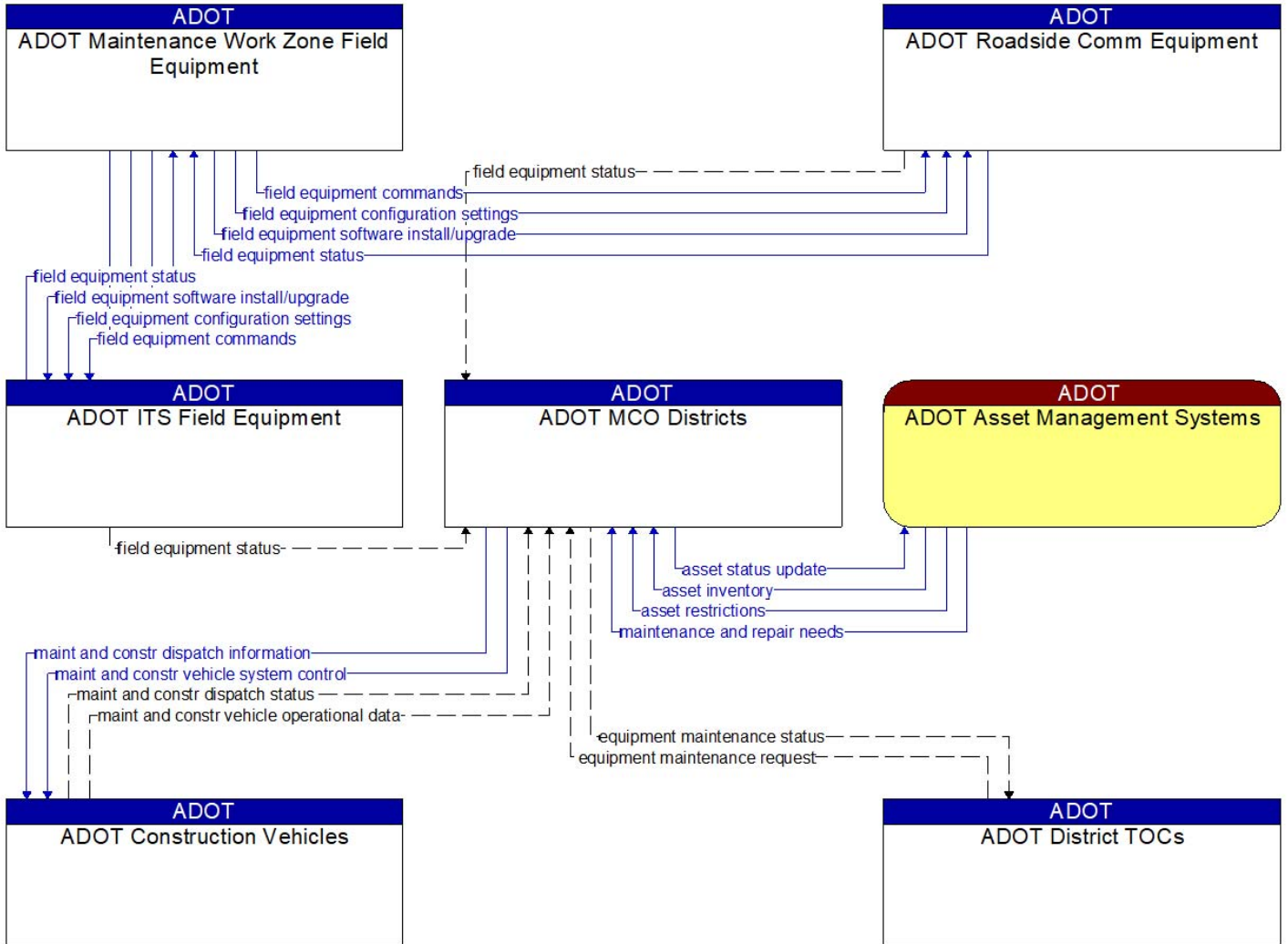

————— Existing  
 - - - - - Planned

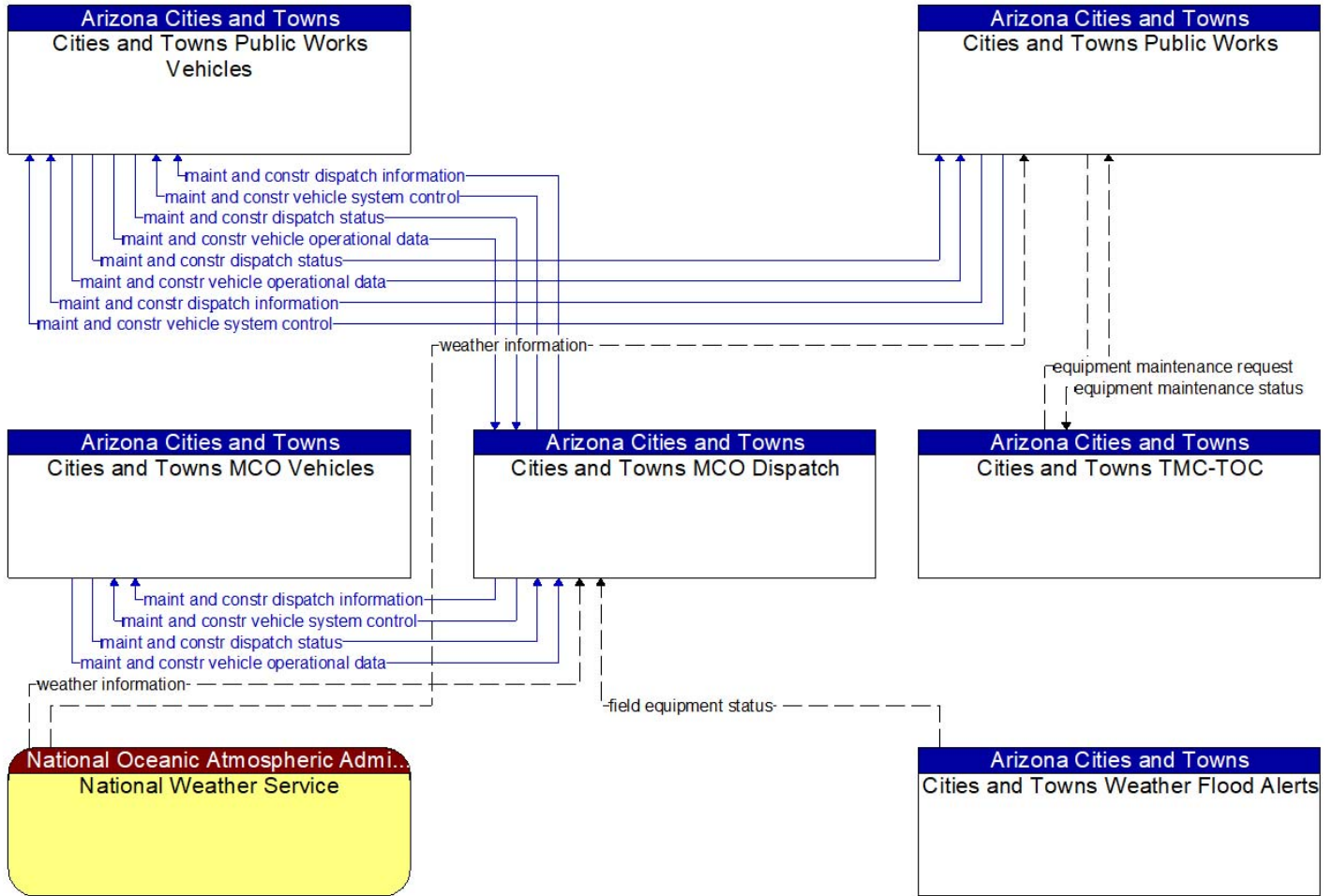

\_\_\_\_\_ Existing  
 - - - - - Planned



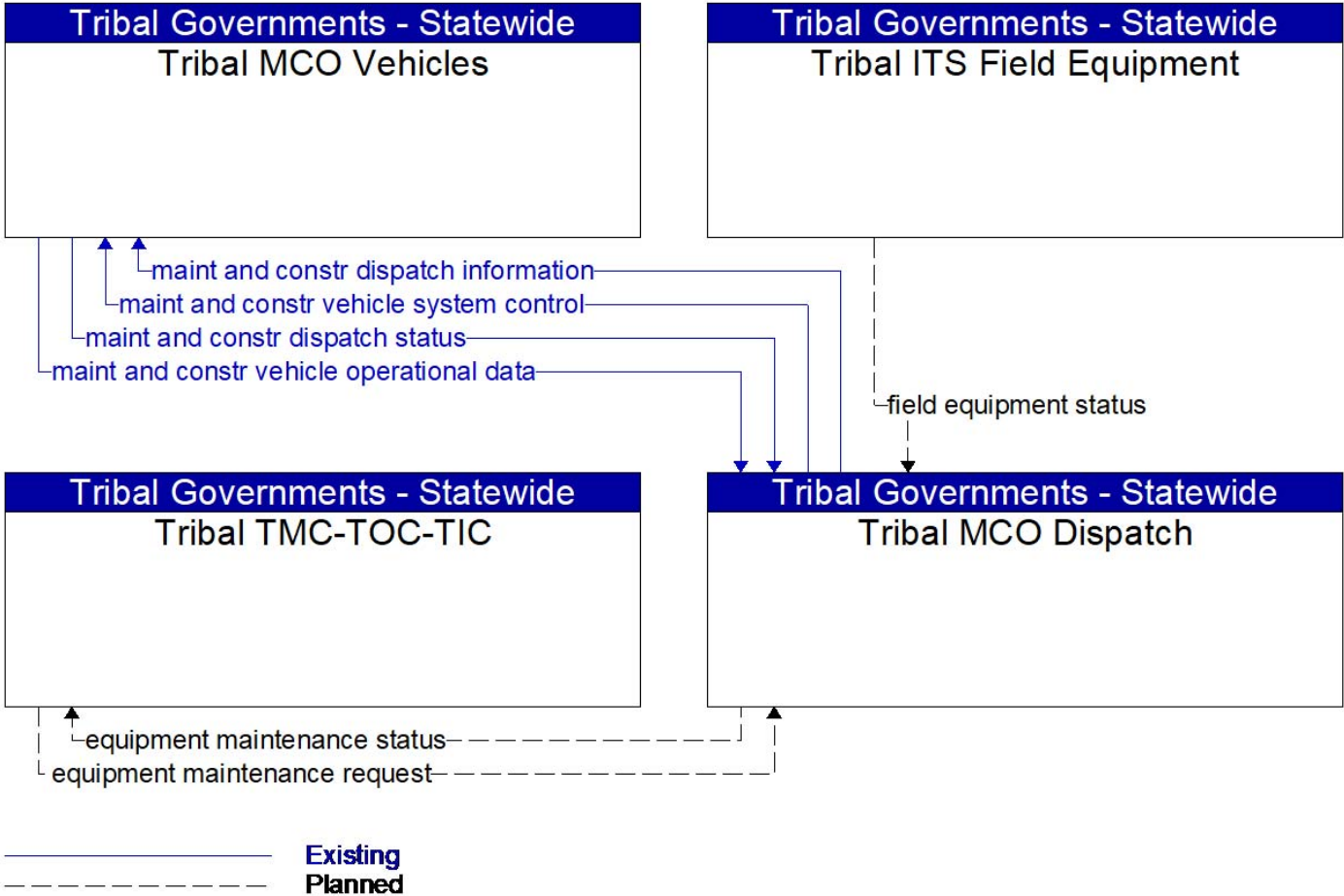

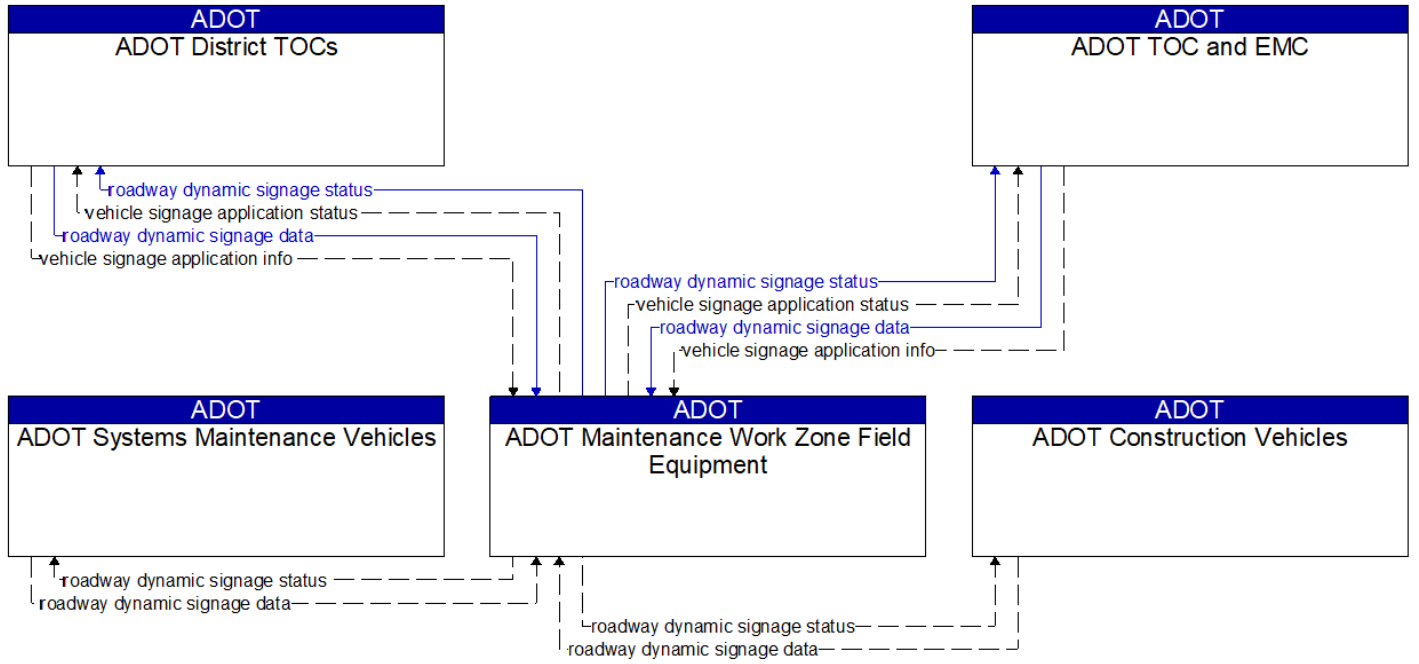

————— Existing  
 - - - - - Planned

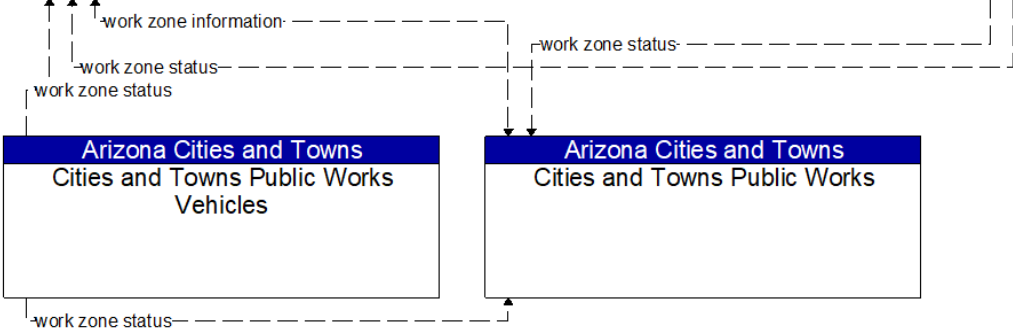
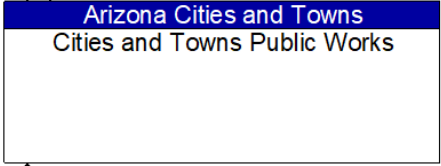
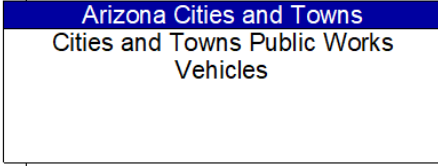
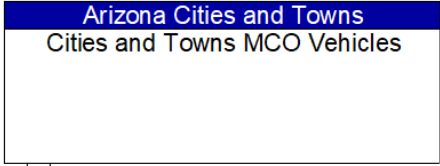
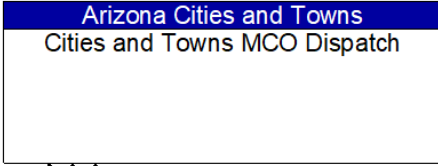

----- **Planned**



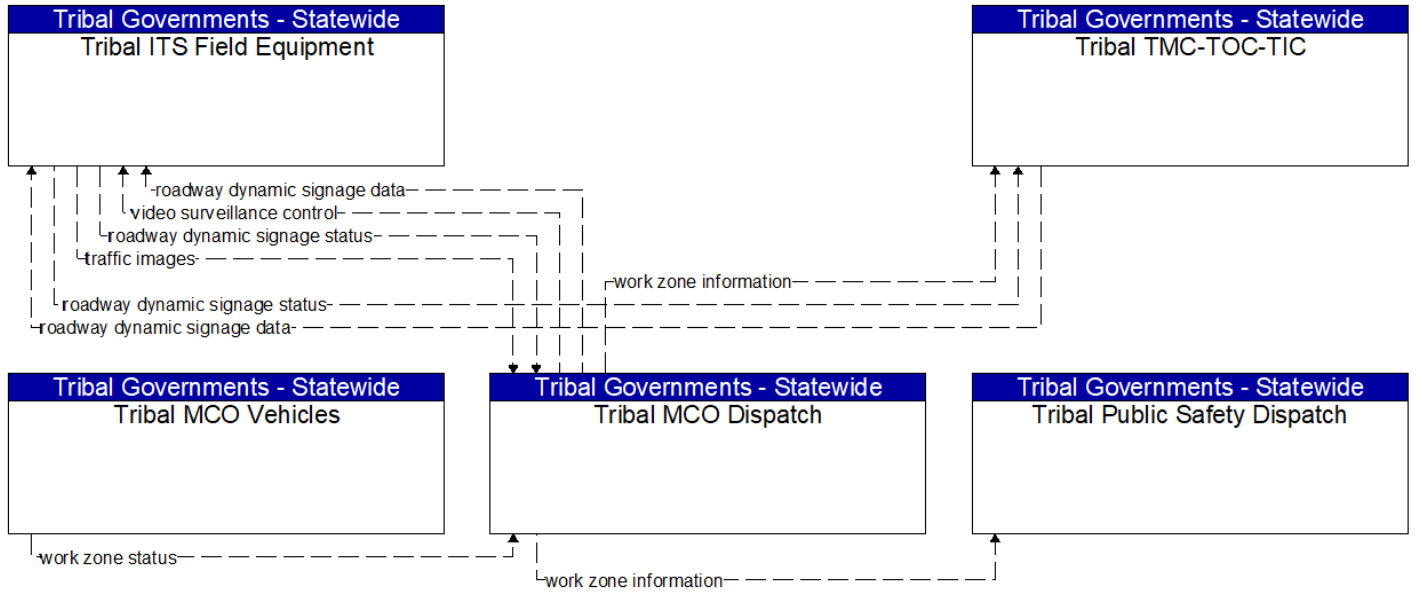

----- **Planned**

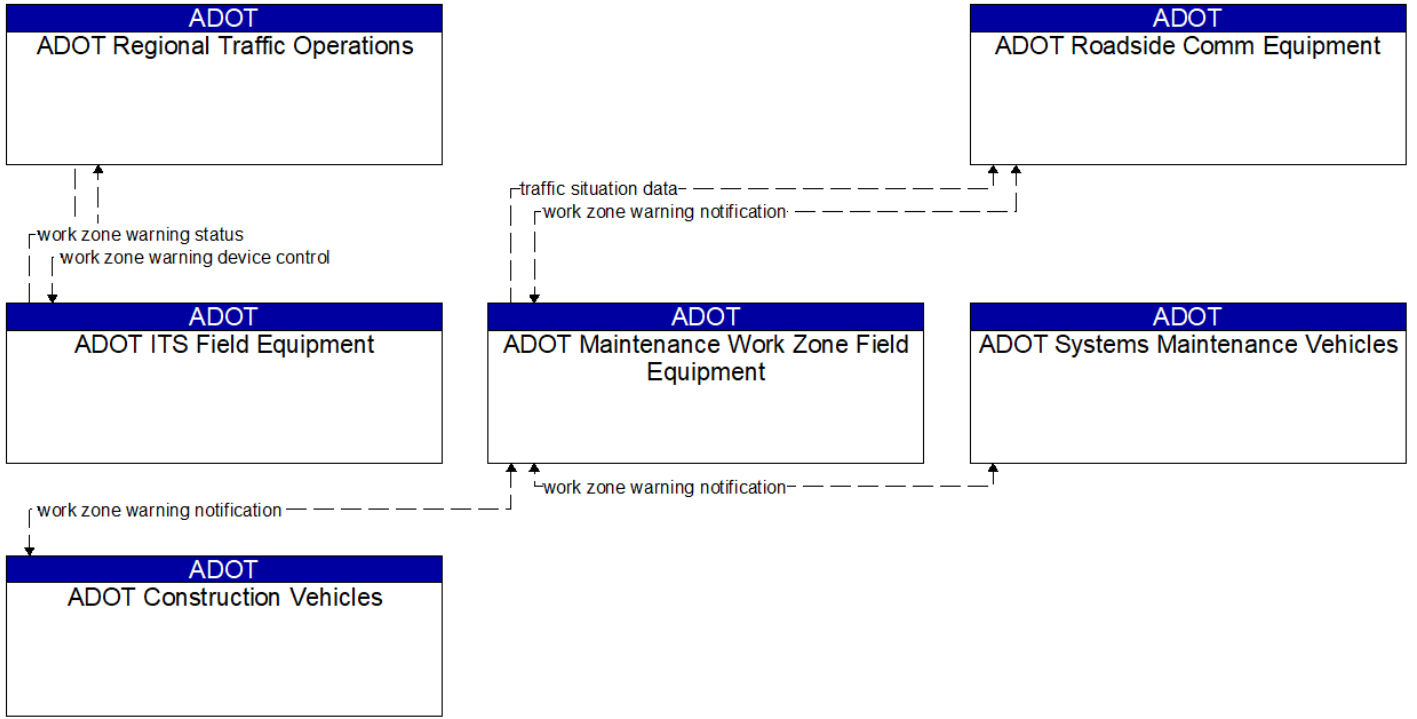

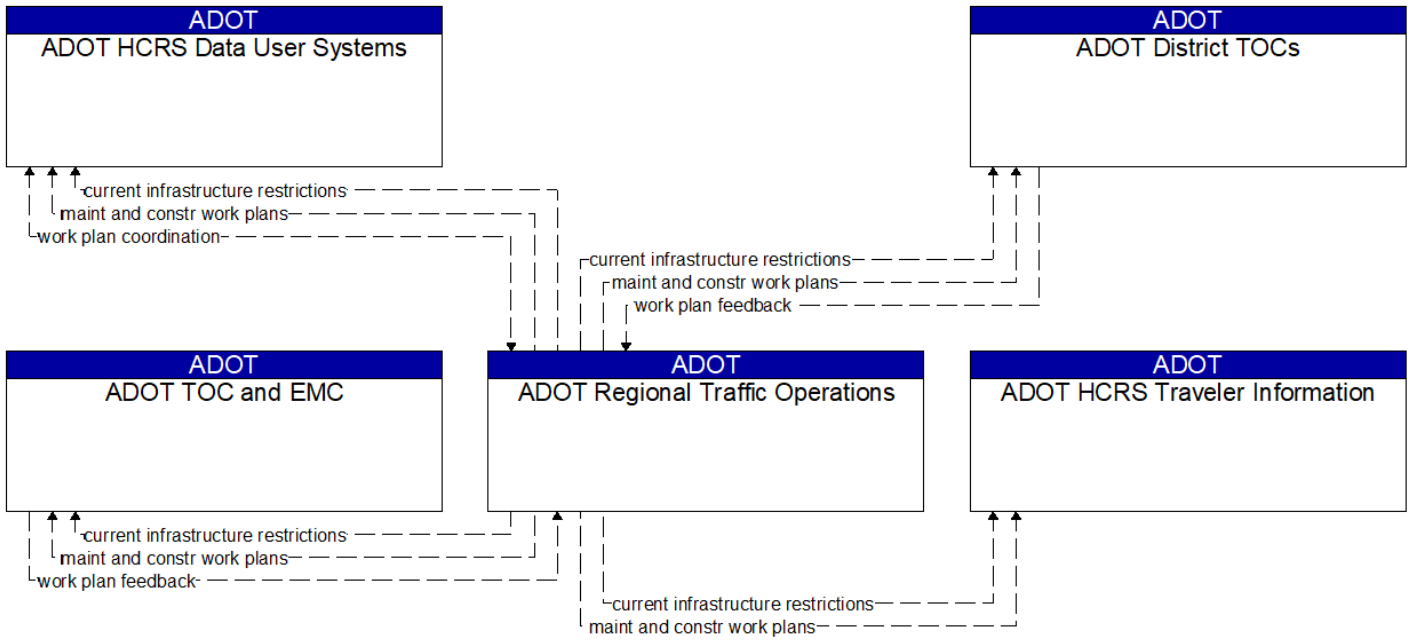

----- Planned

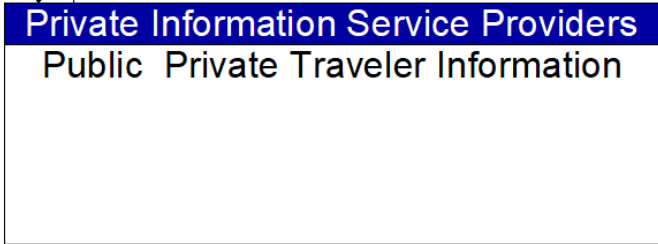
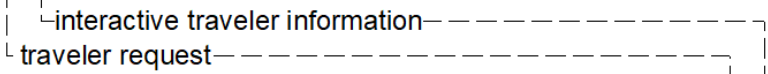
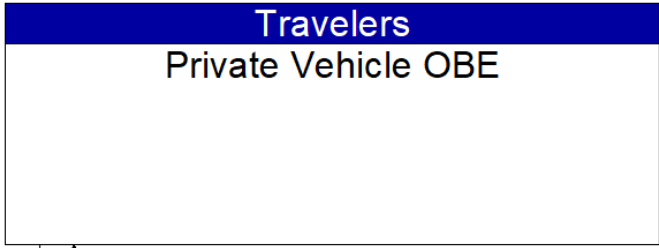

----- **Planned**

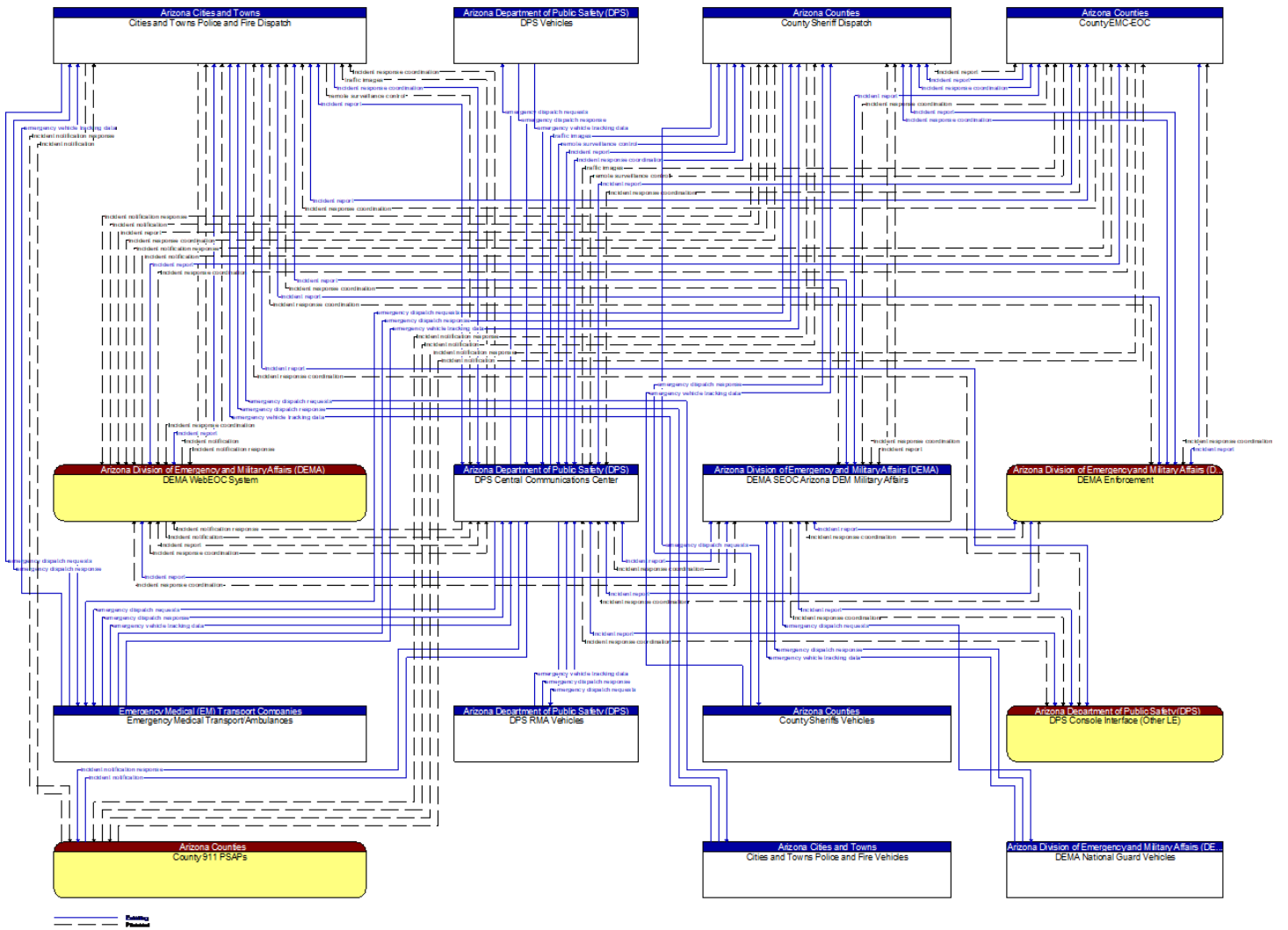

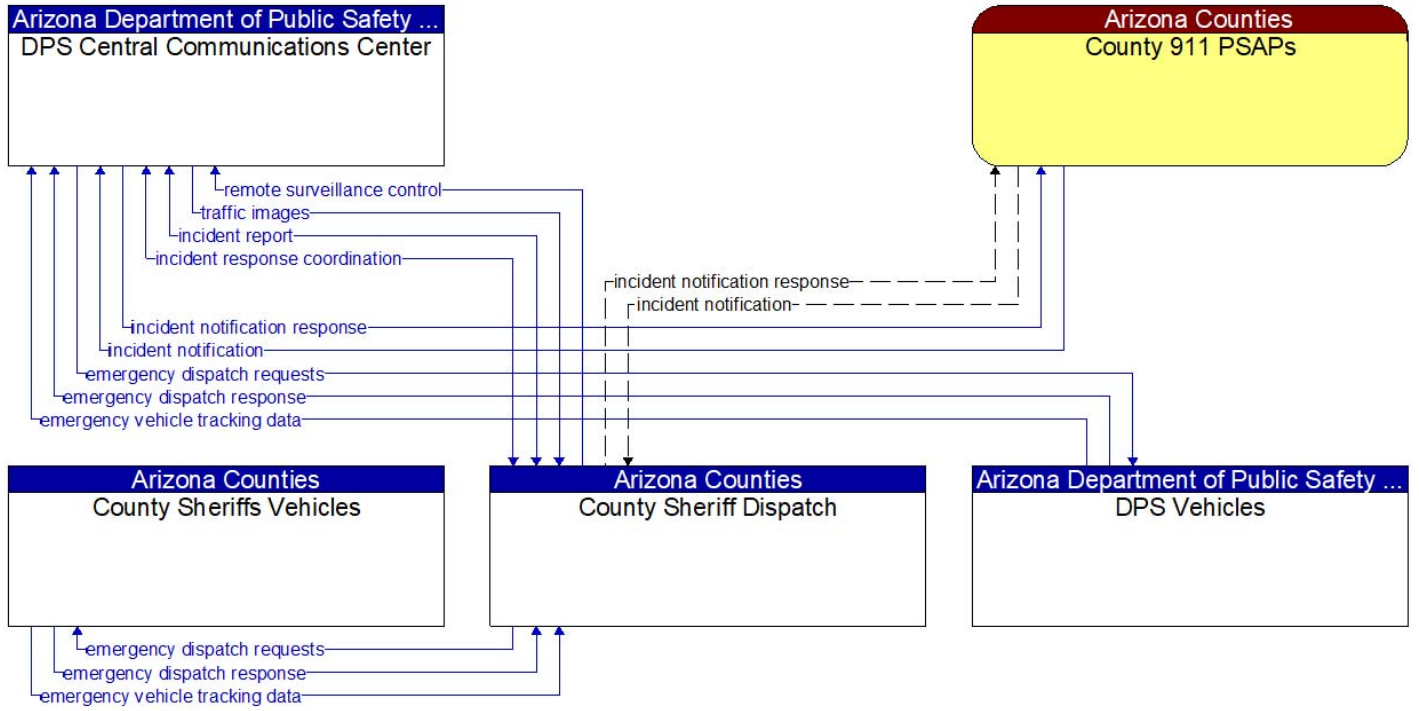

\_\_\_\_\_ Existing  
 - - - - - Planned

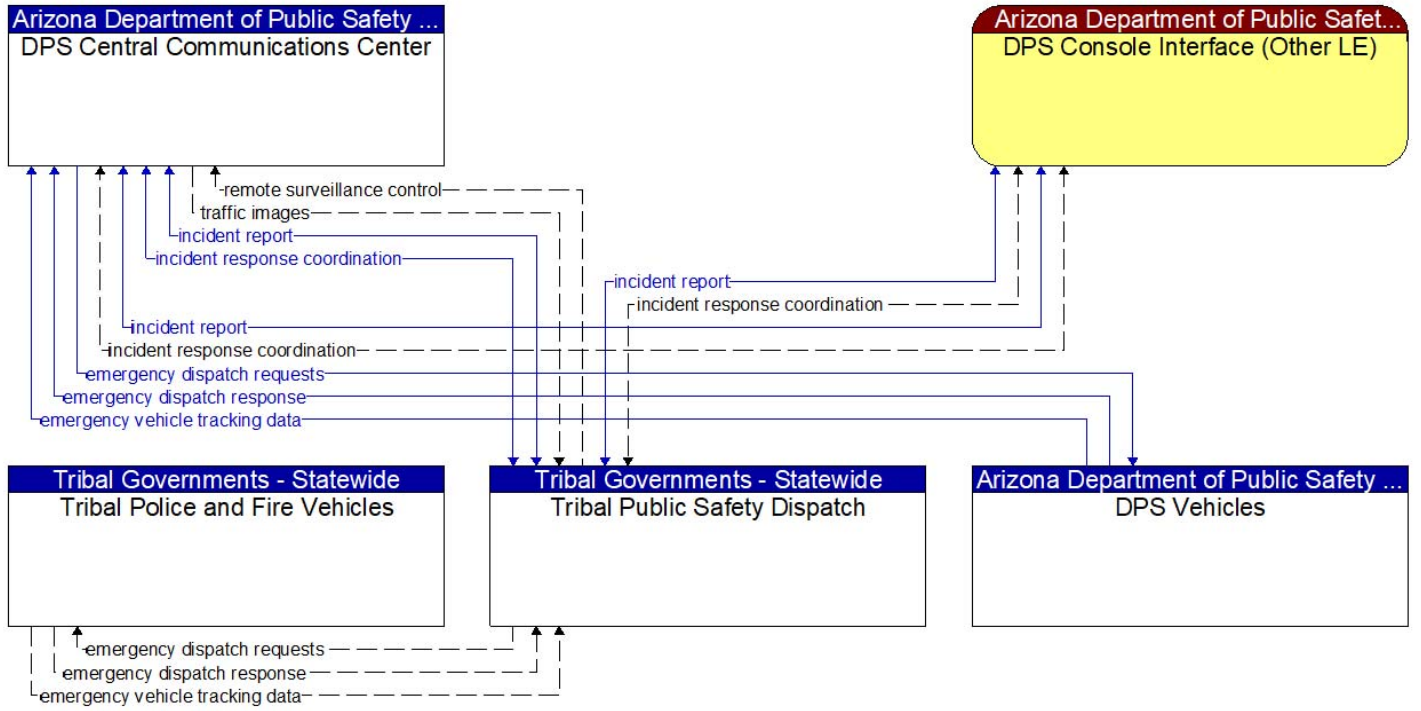

\_\_\_\_\_ Existing  
 - - - - - Planned

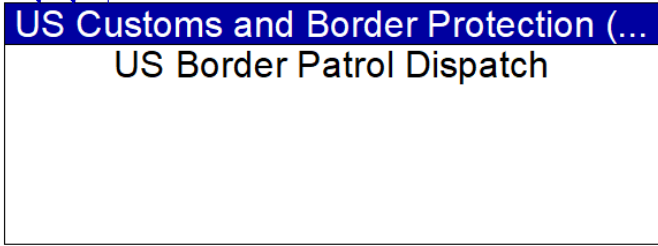
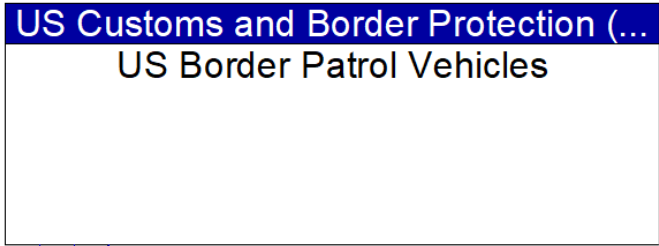

Existing



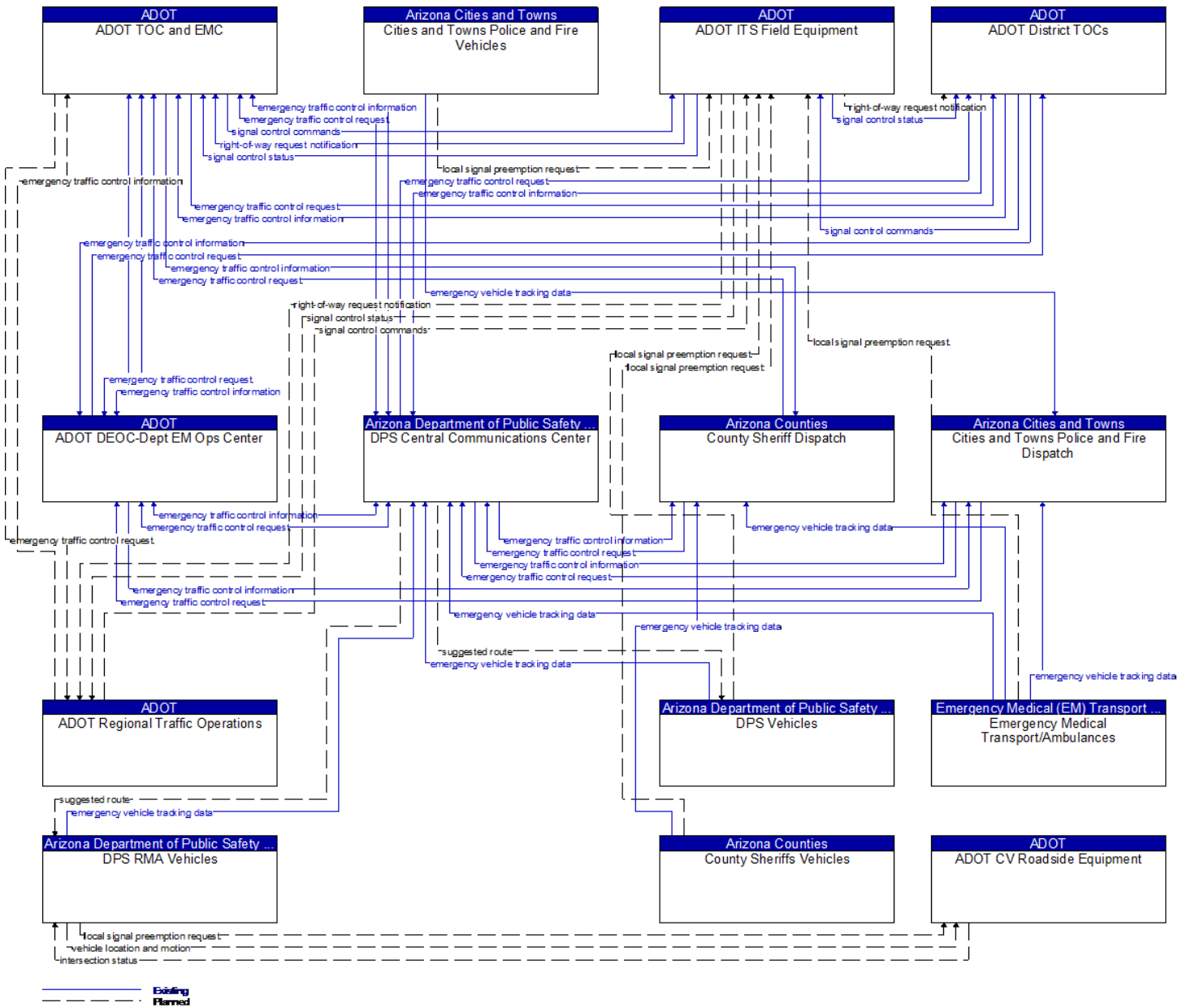

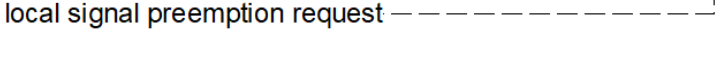
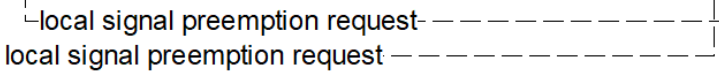
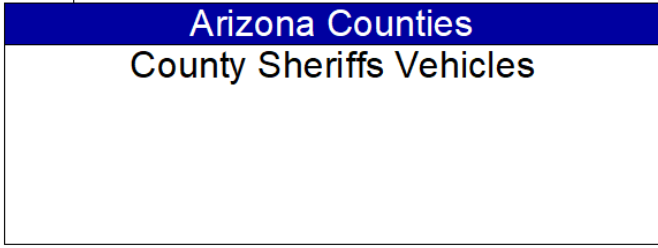
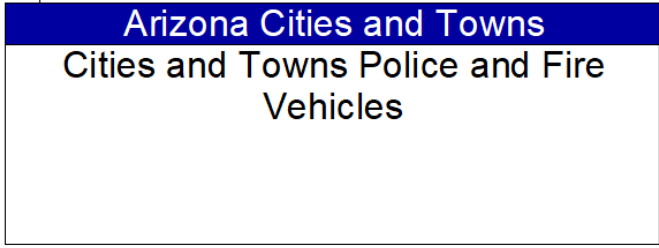
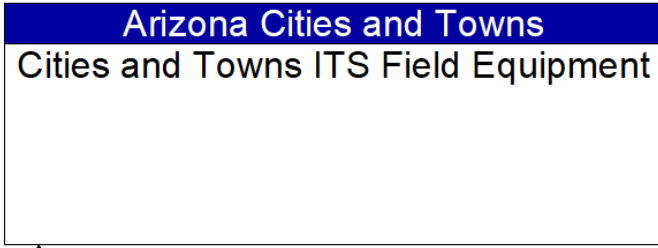
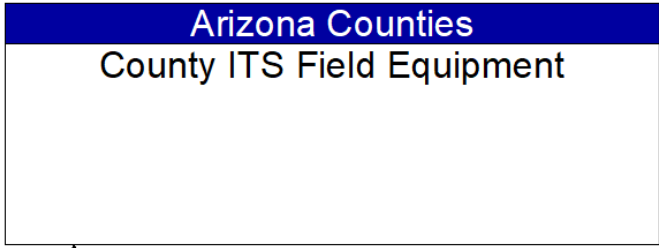

----- **Planned**

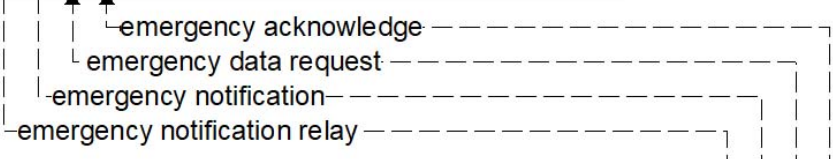
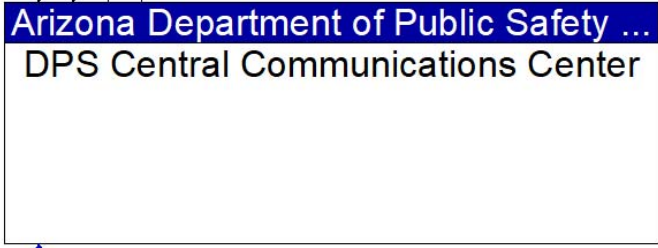
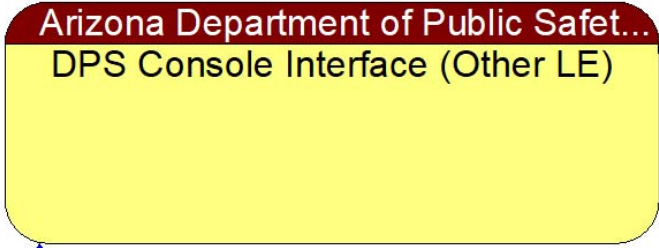
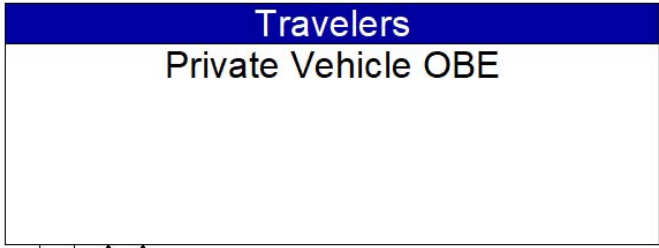

———— Existing  
----- Planned

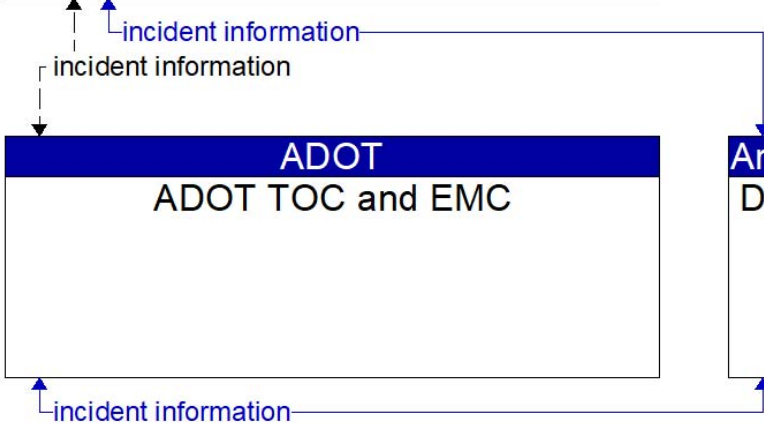
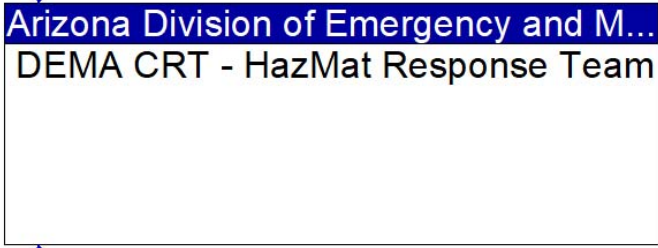
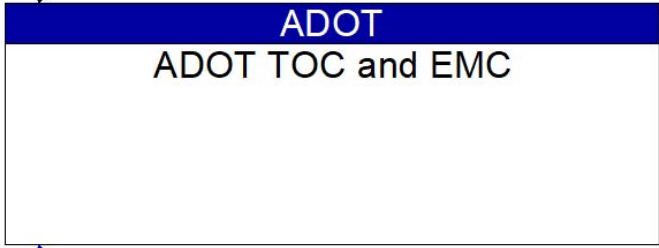
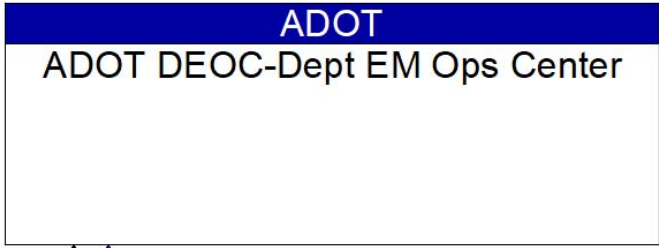

———— Existing  
----- Planned

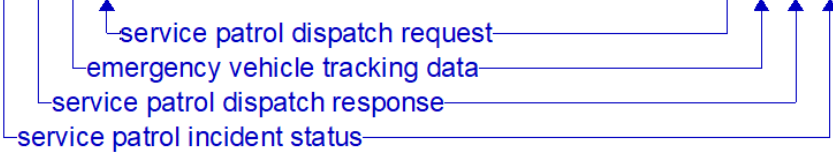
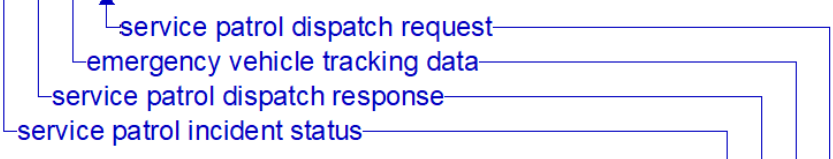
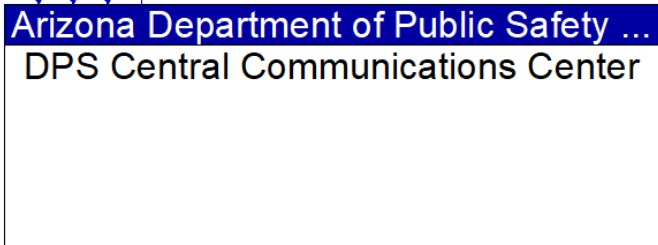
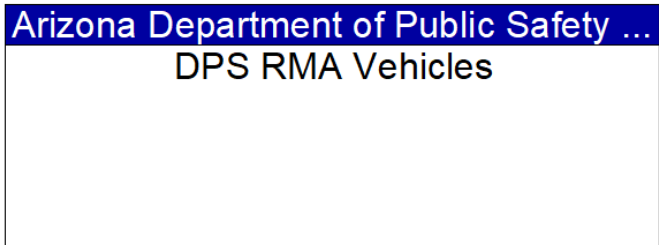
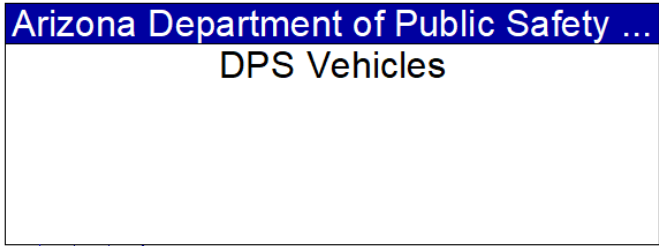

Existing

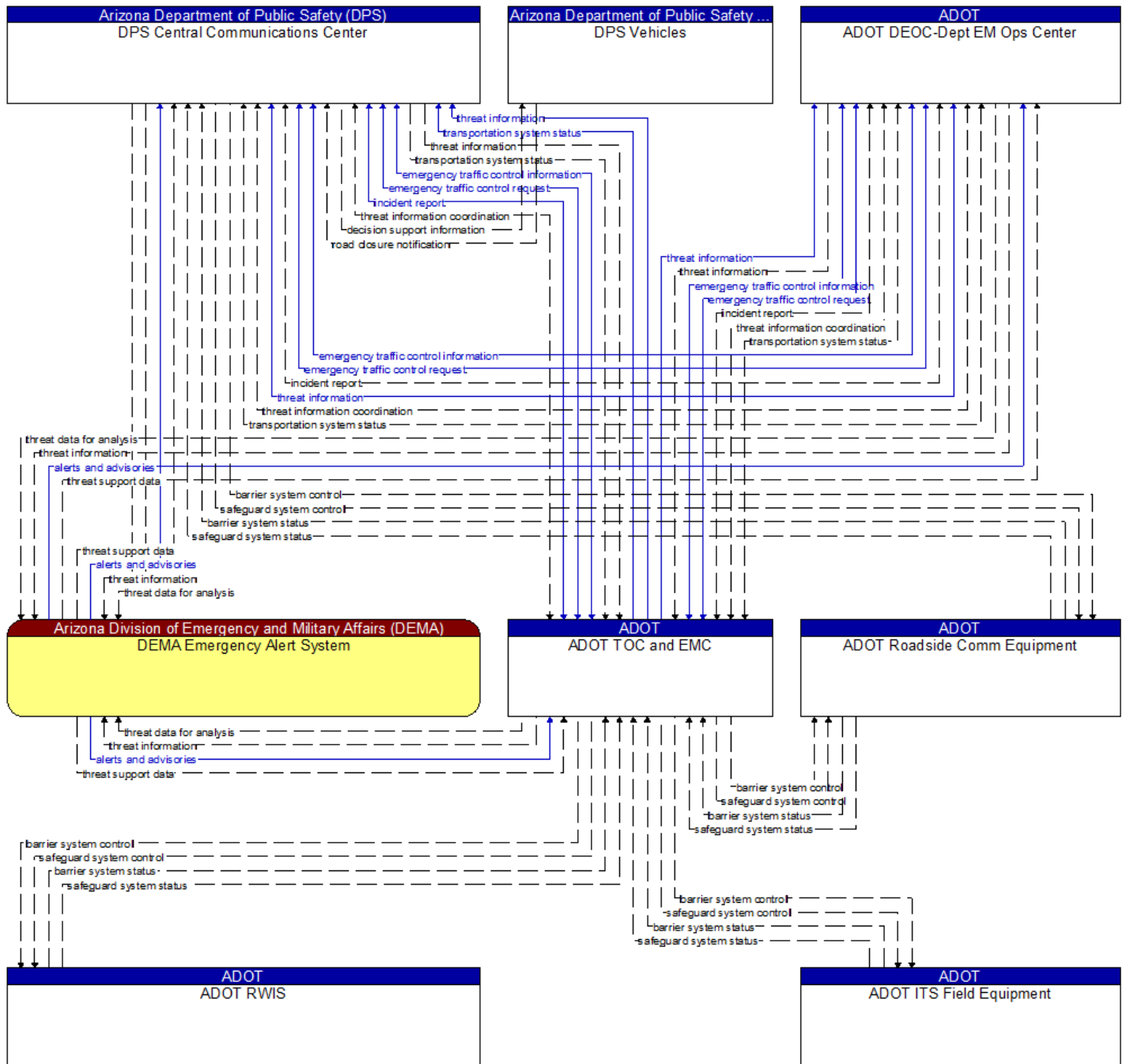

— Existing  
 - - - Planned

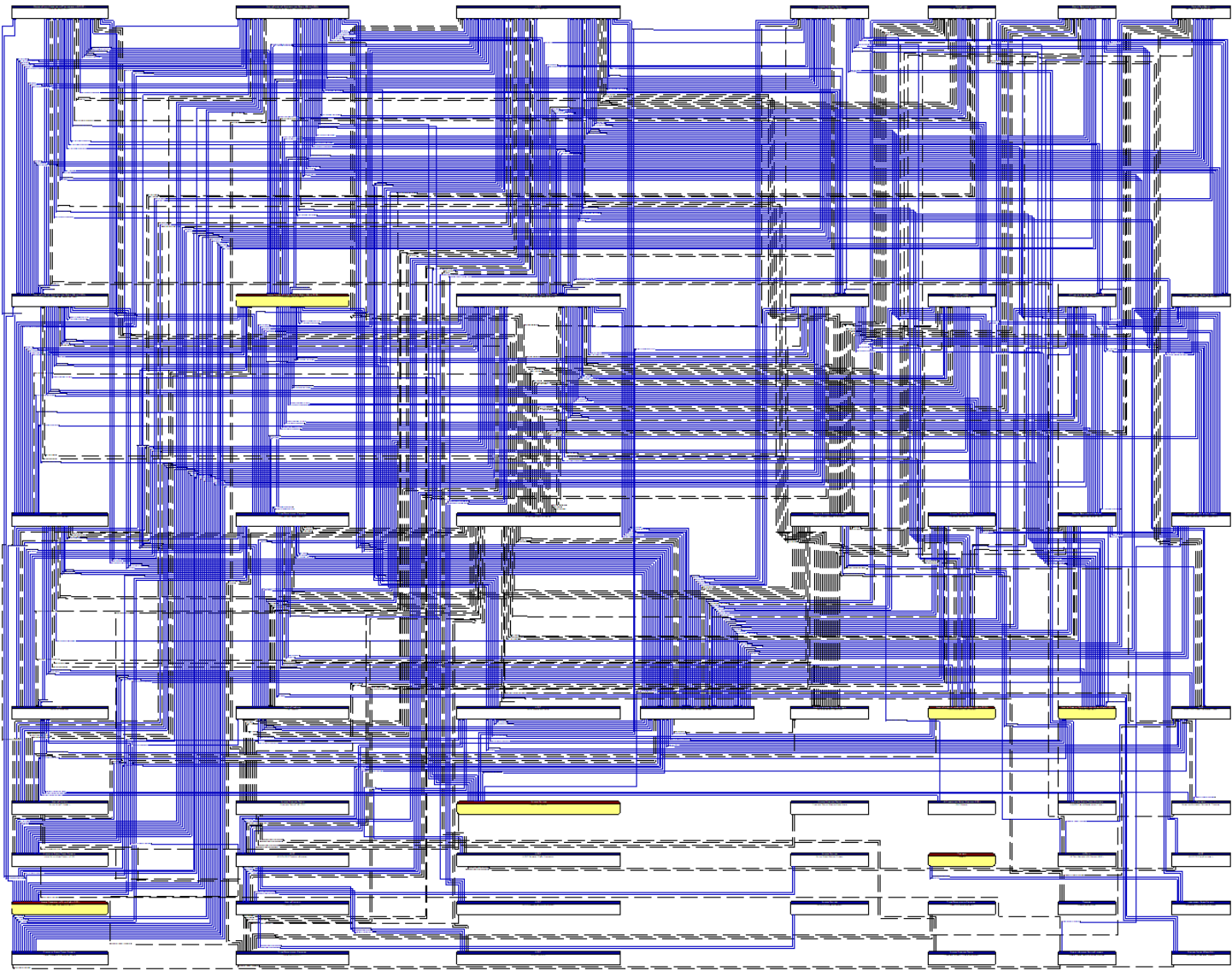





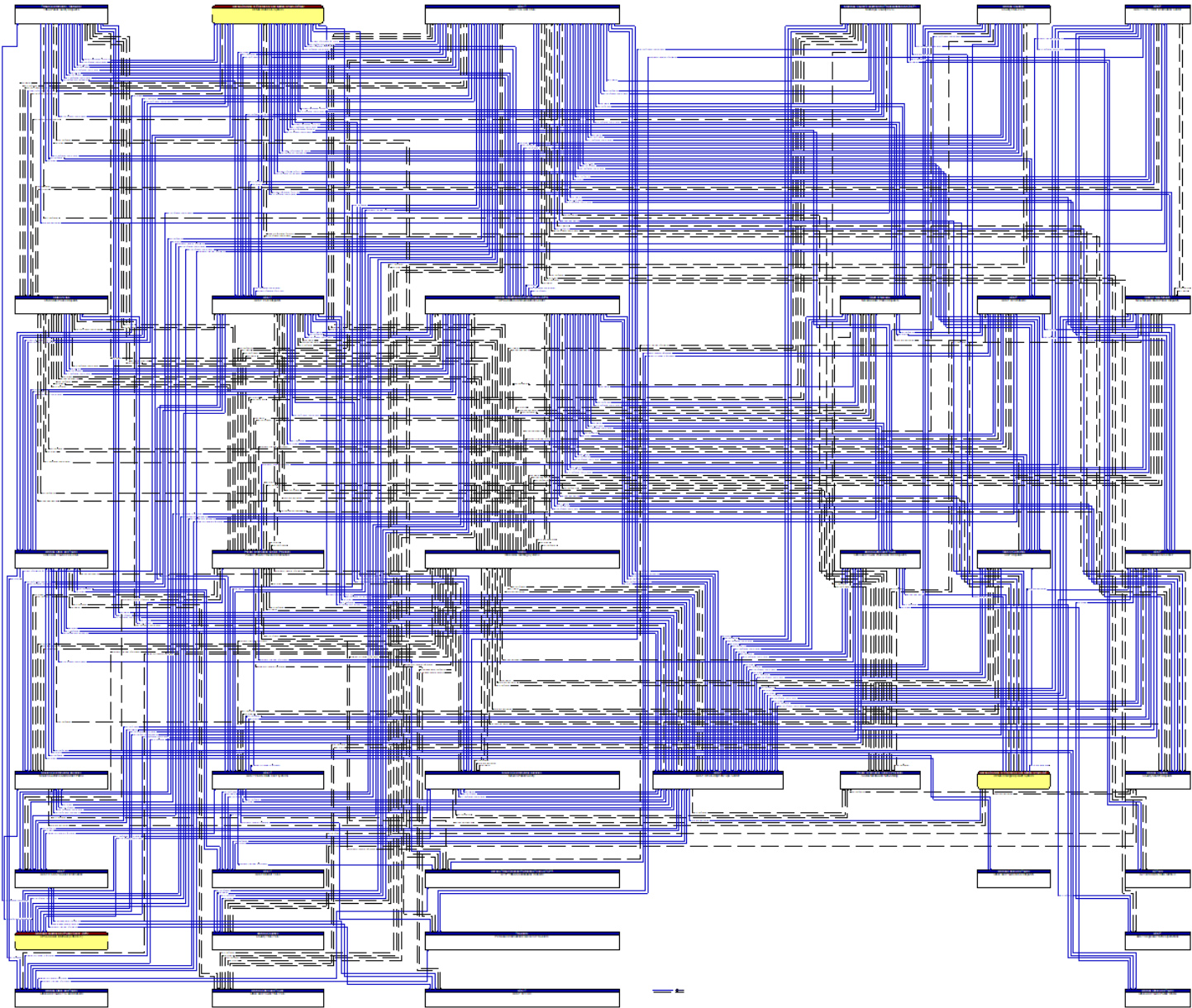

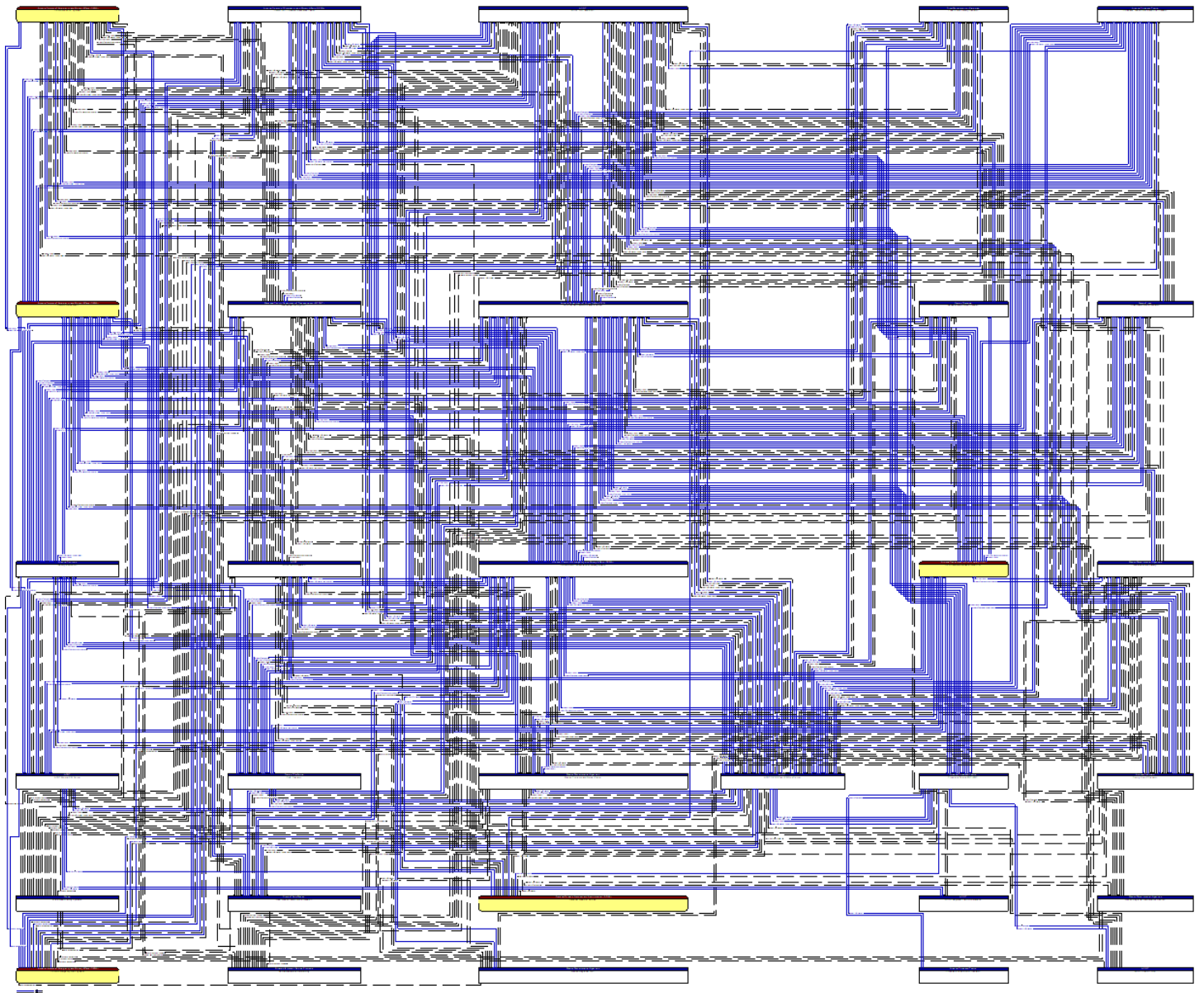

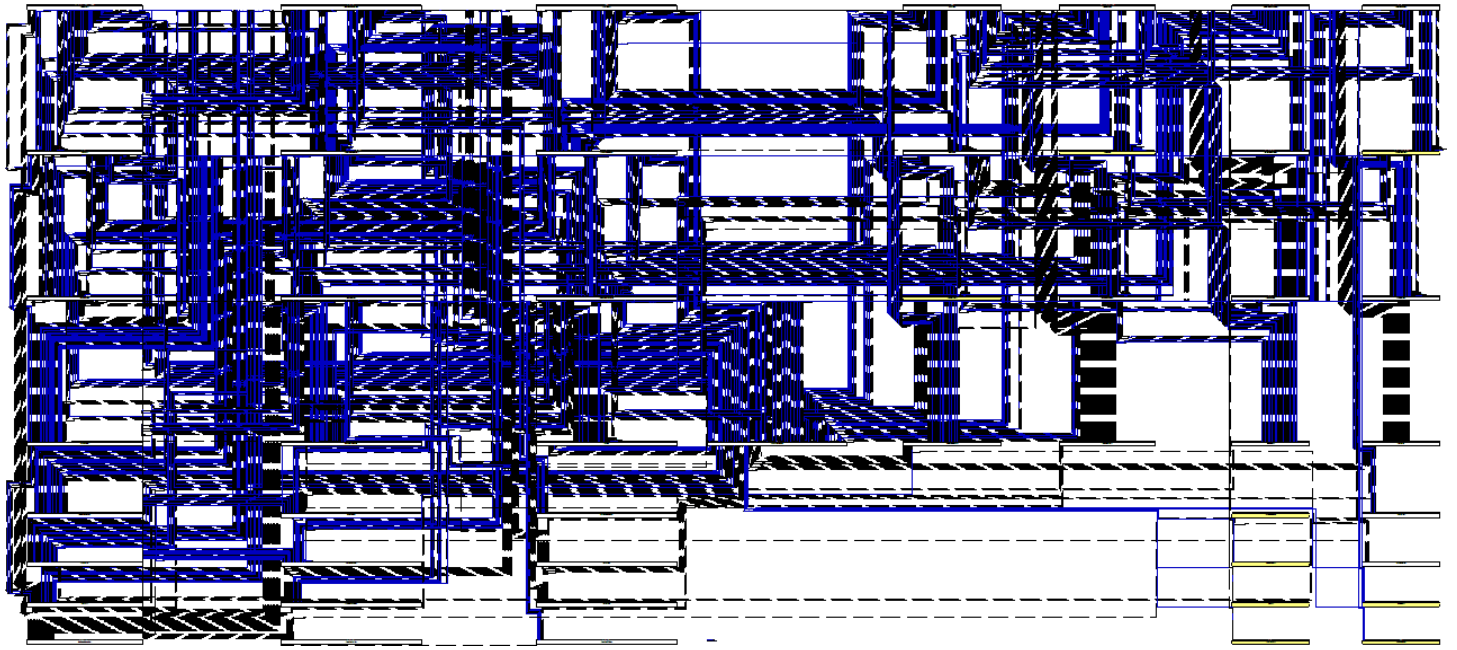

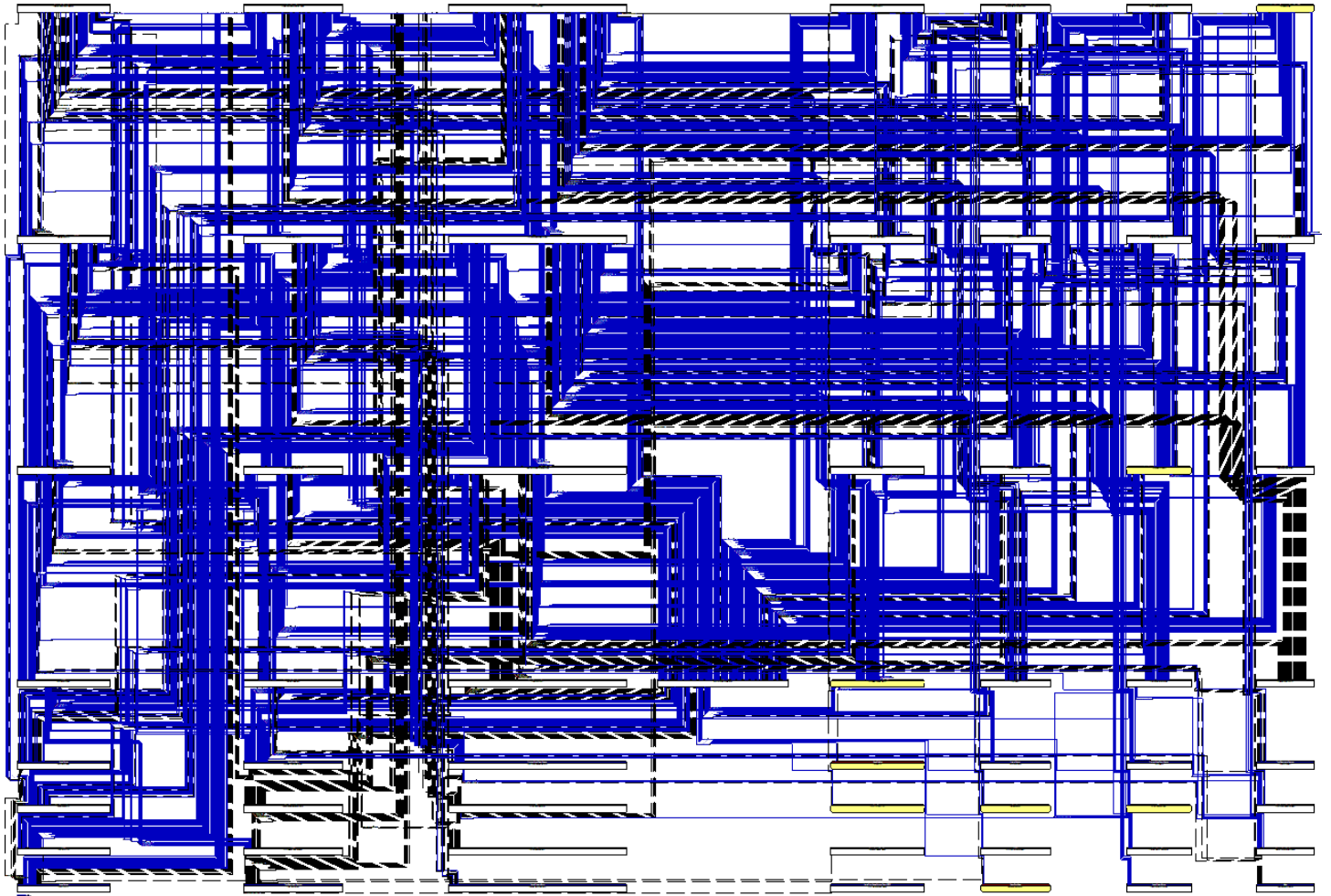

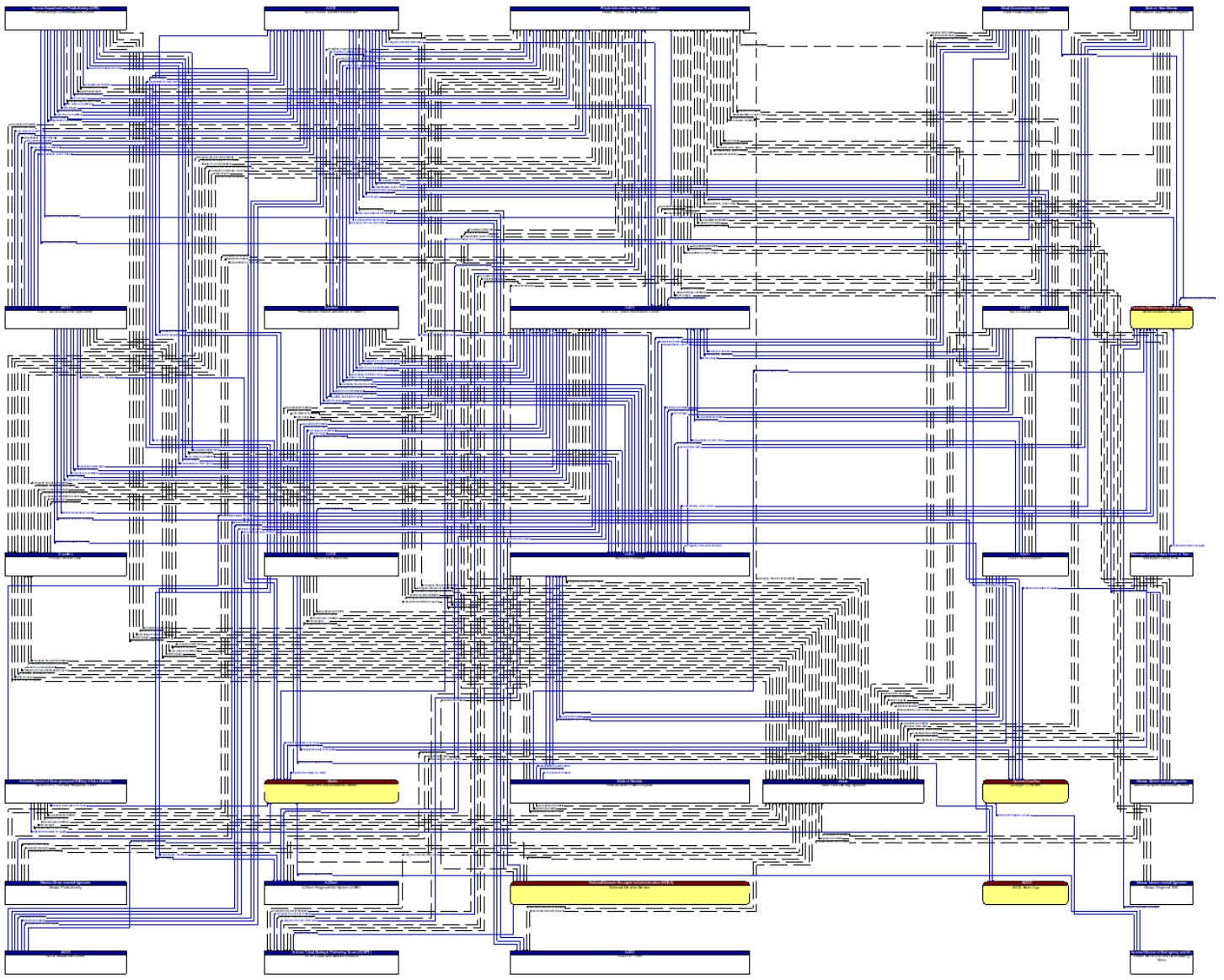

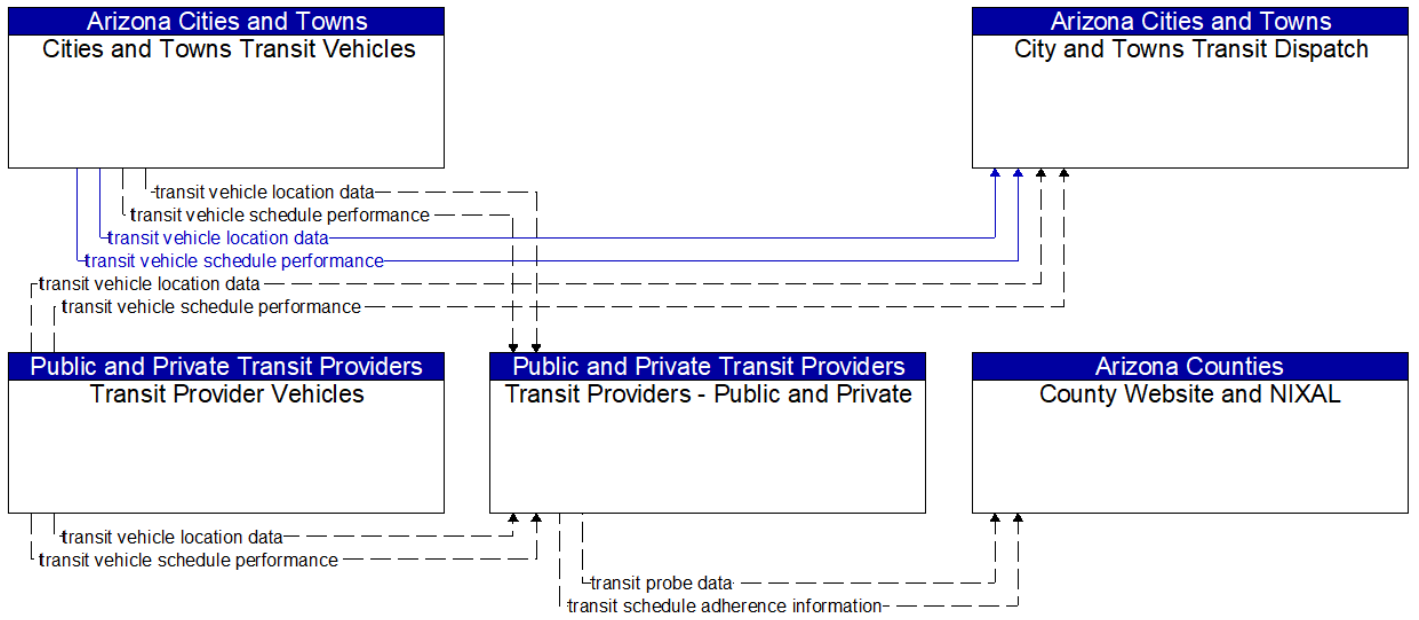

————— Existing  
 - - - - - Planned

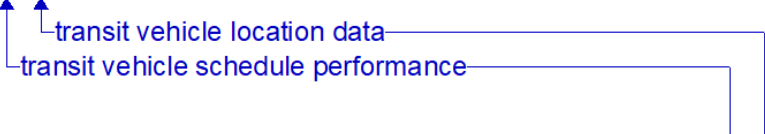
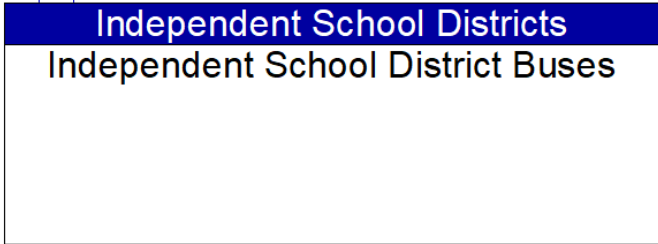
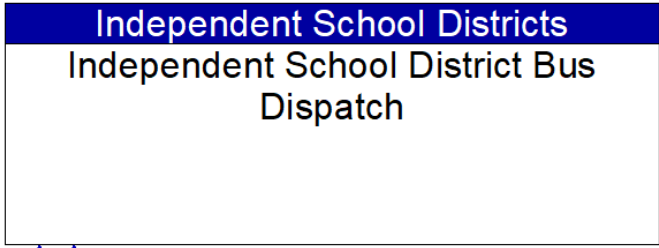

Existing

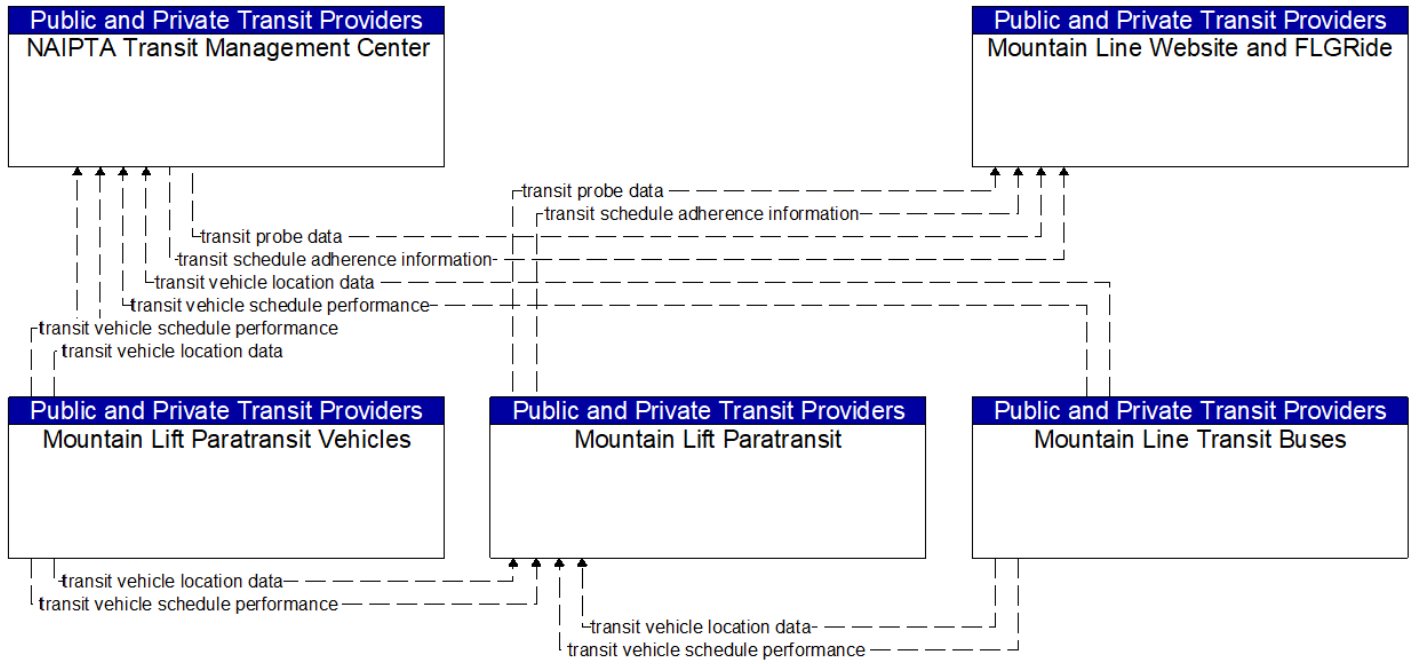

----- **Planned**



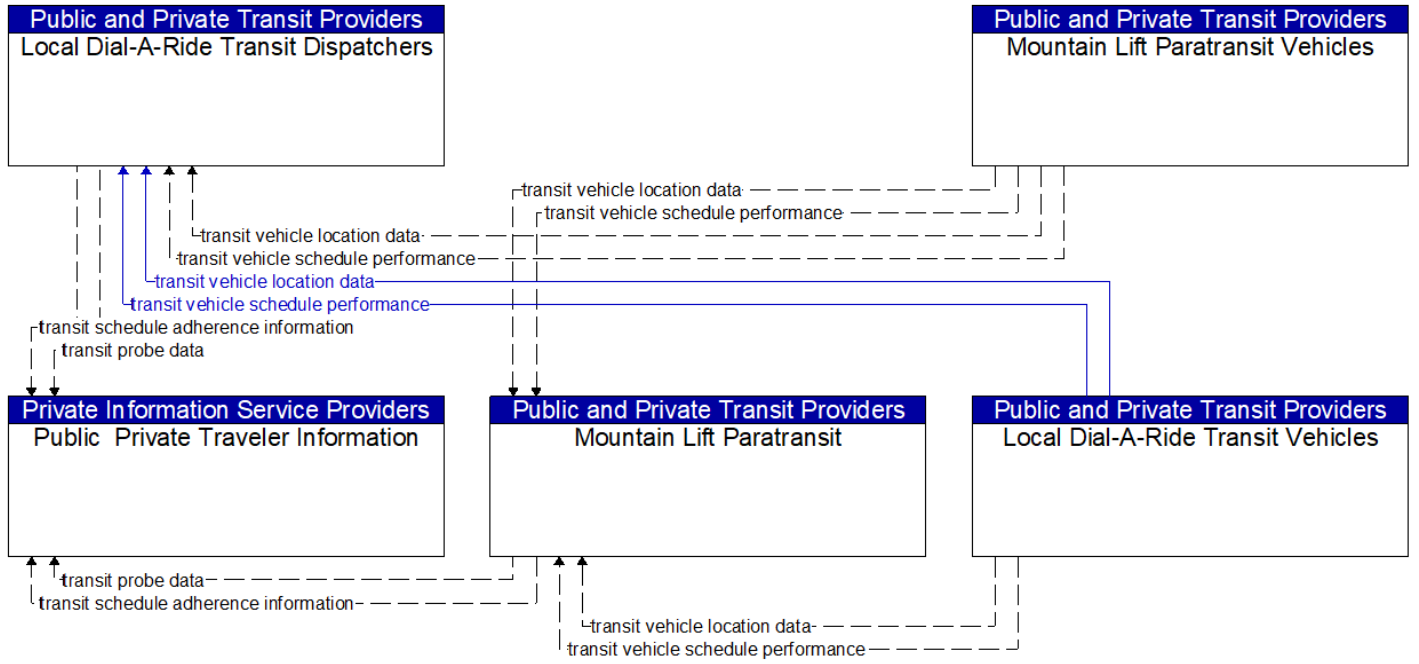

\_\_\_\_\_ Existing  
 - - - - - Planned

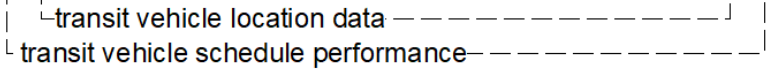
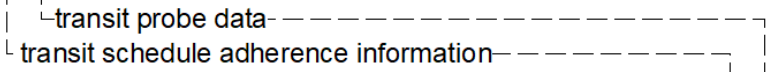
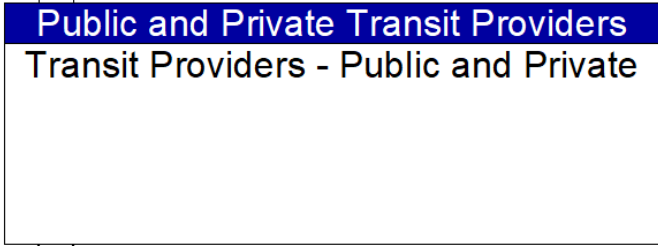
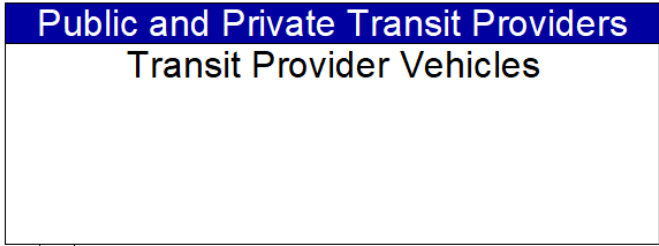
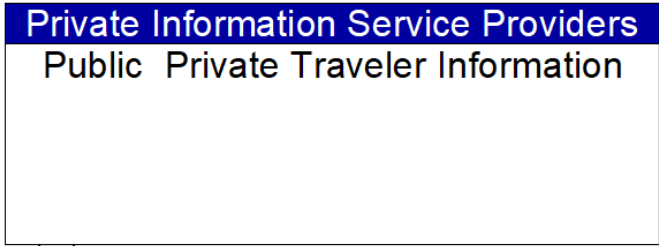

----- **Planned**

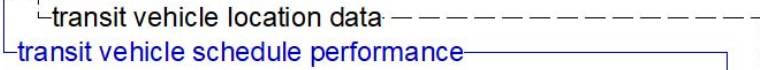
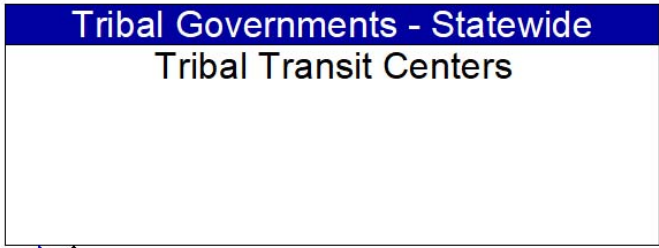

Existing  
Planned

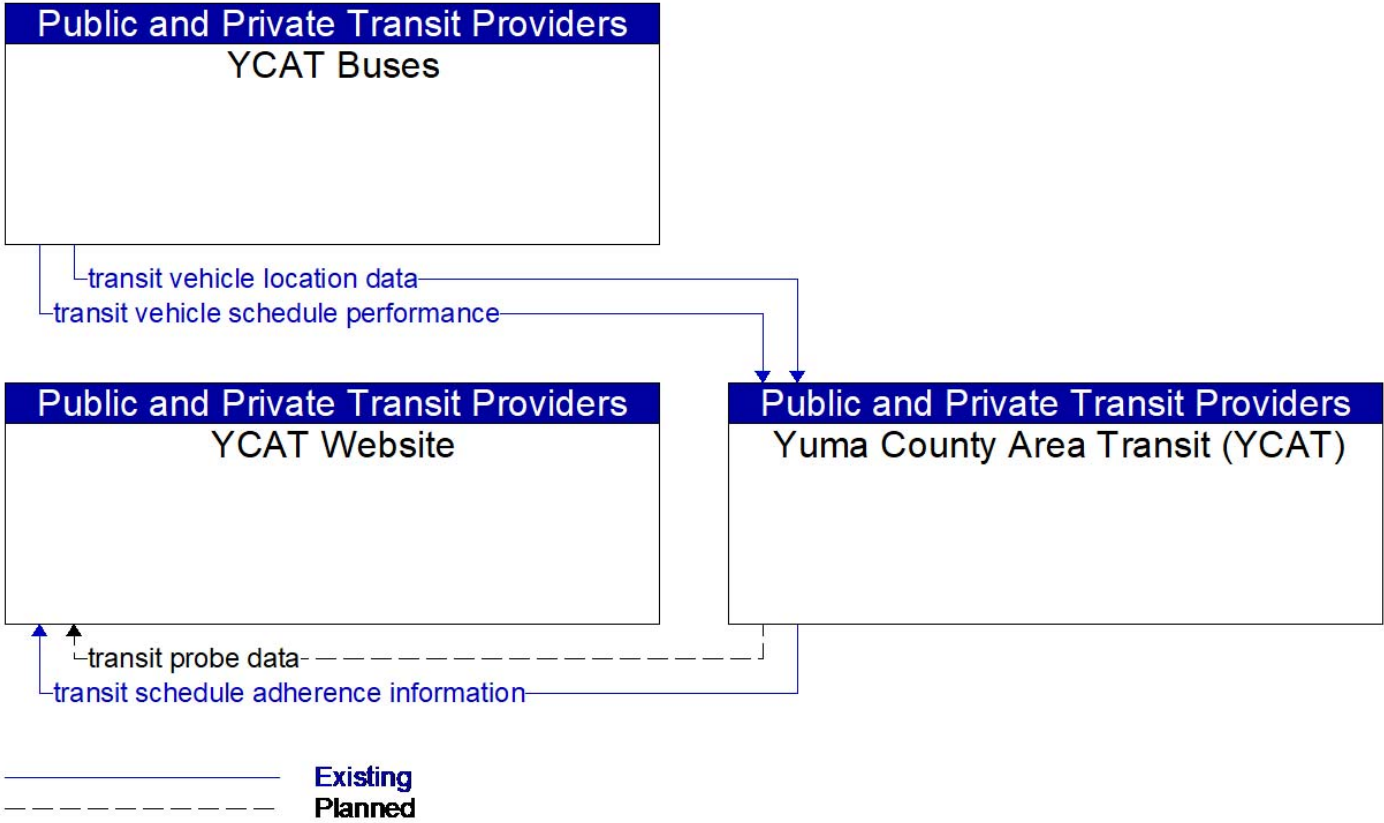



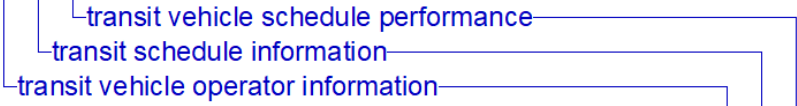
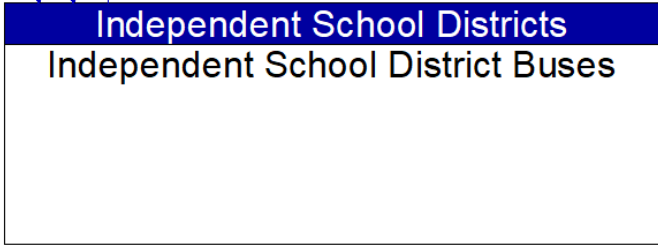
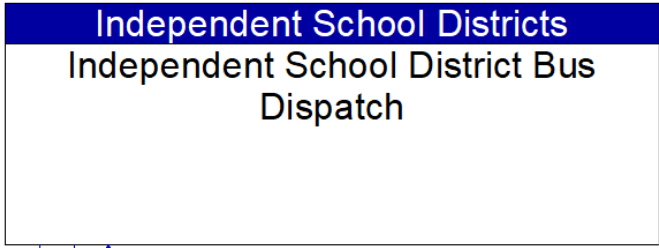

Existing

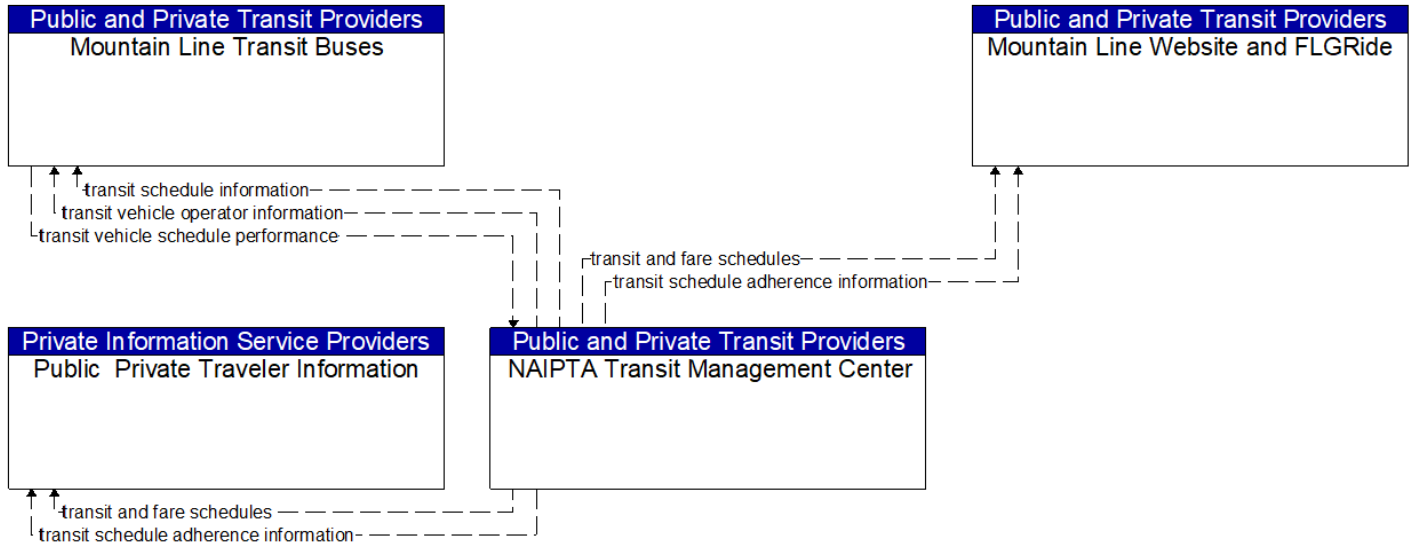

----- **Planned**

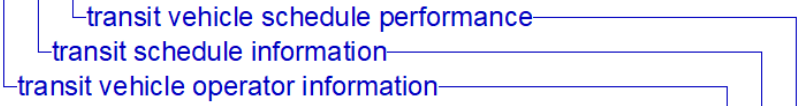
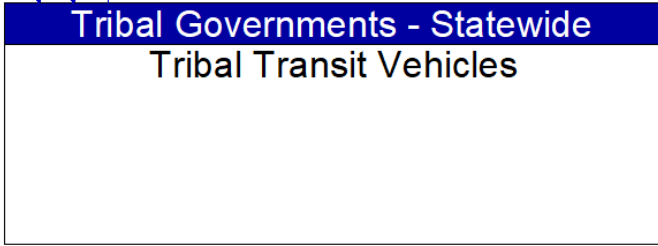
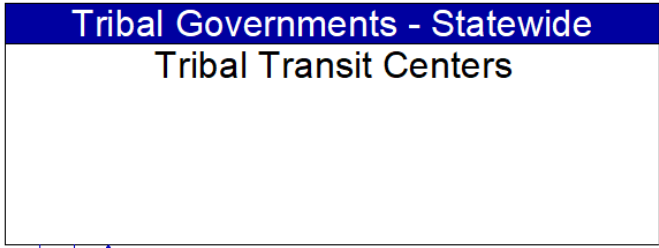

Existing



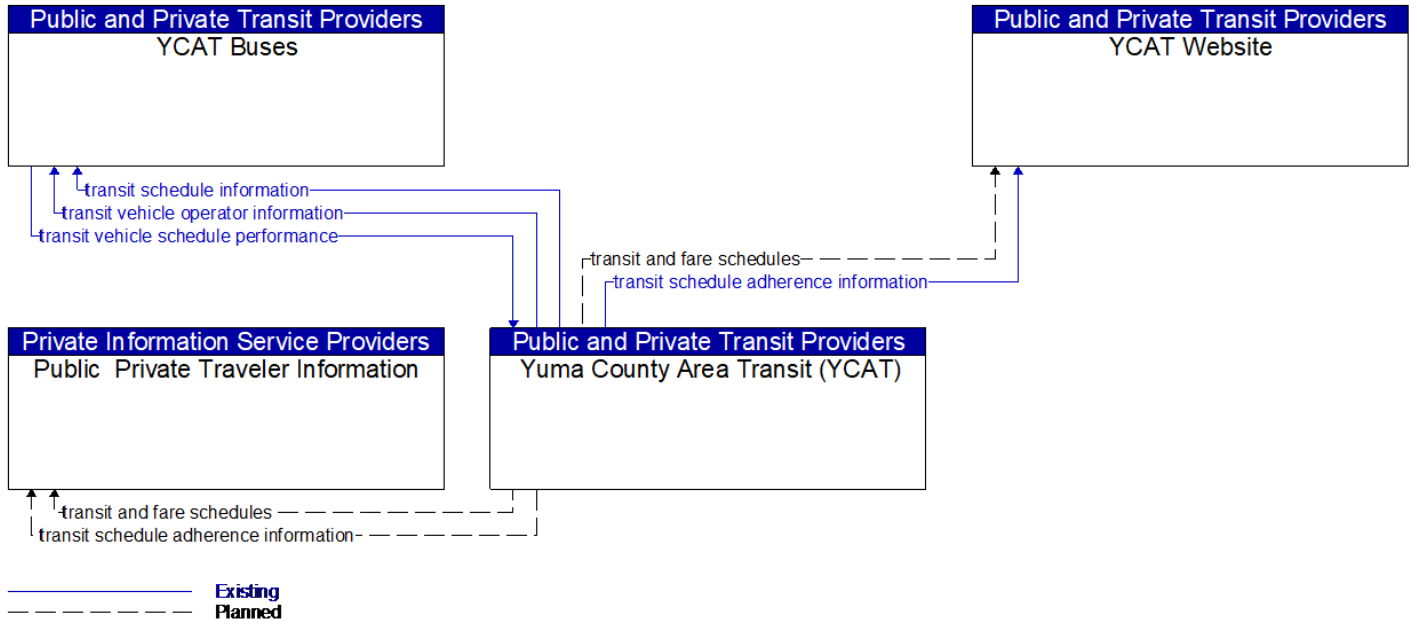

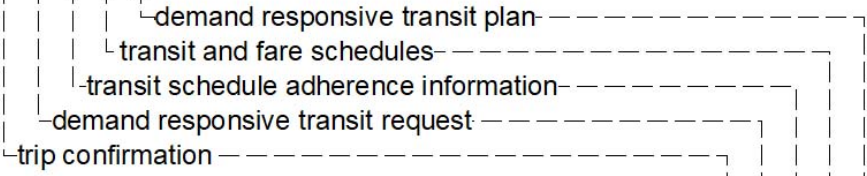
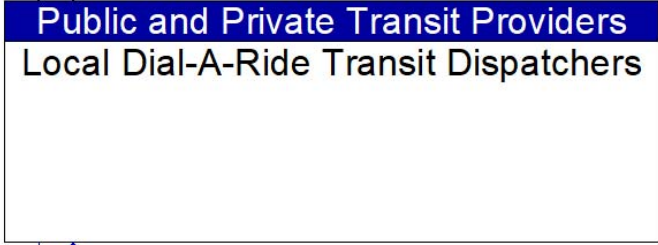
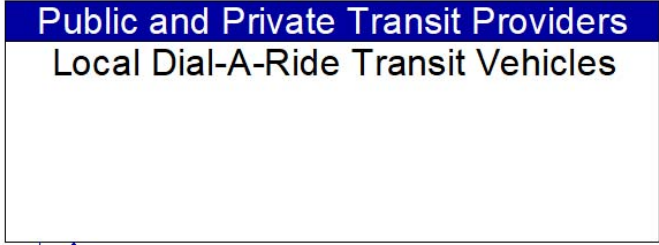
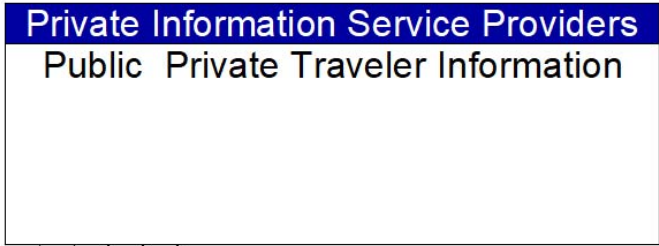

———— Existing  
----- Planned



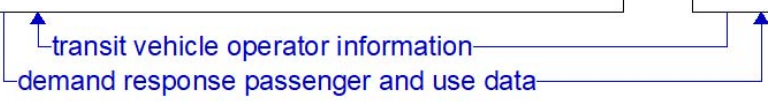
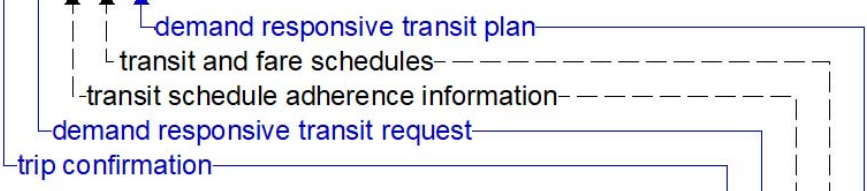
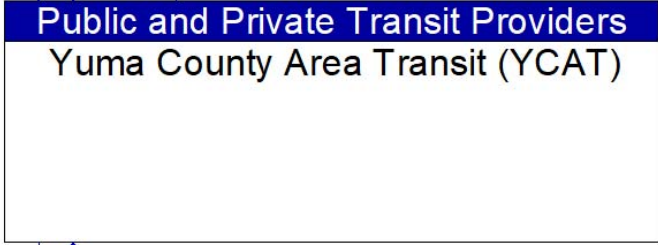
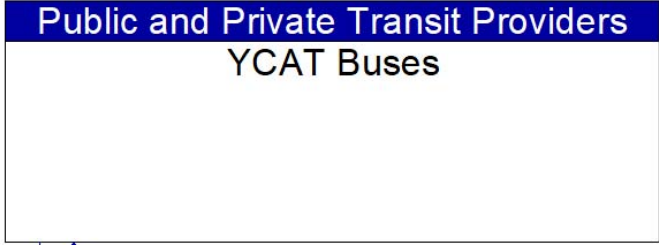
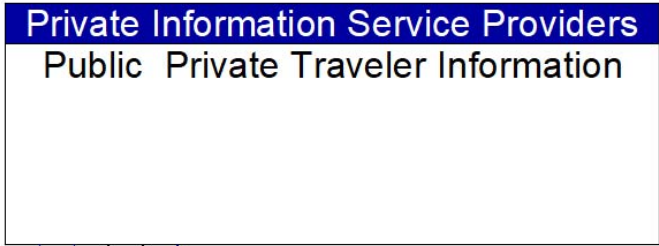

———— Existing  
----- Planned

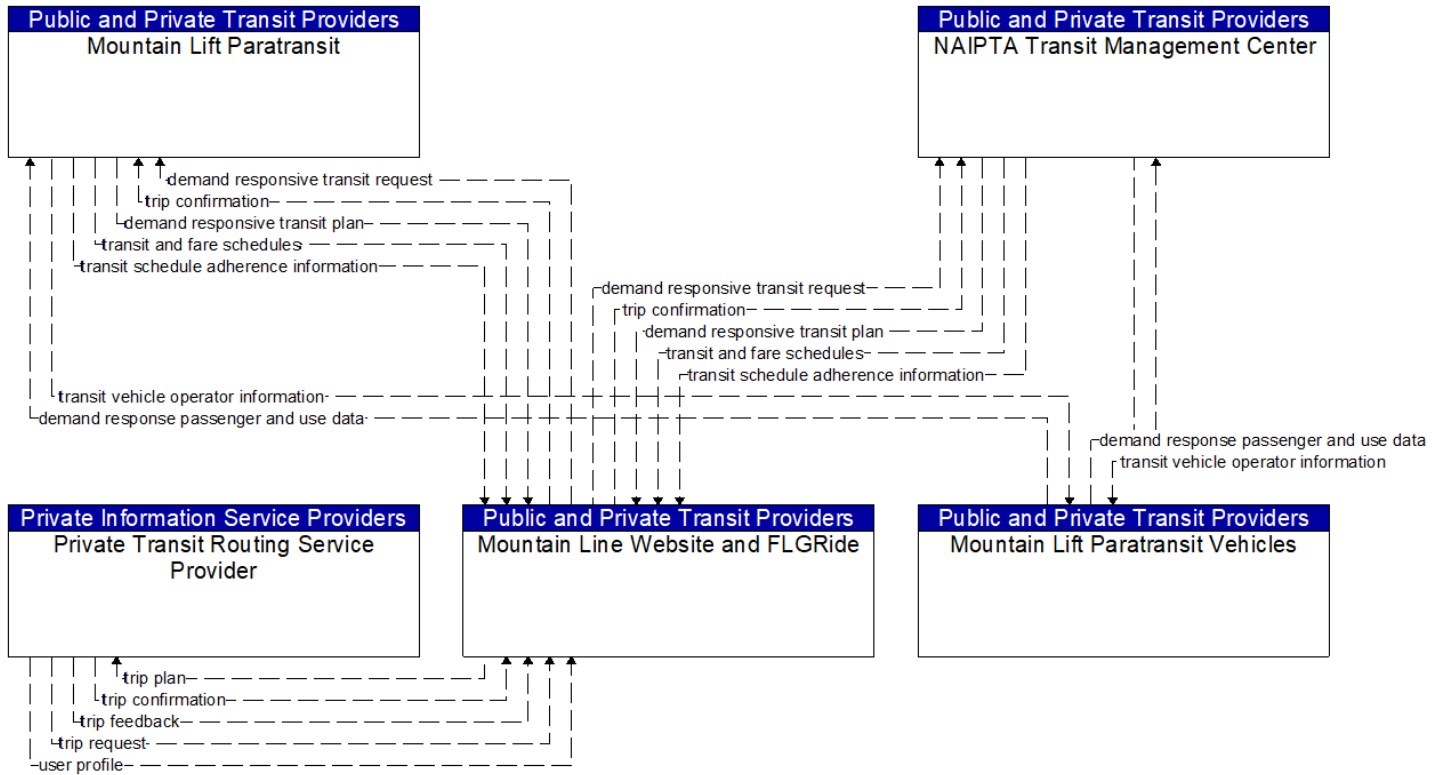

----- Planned

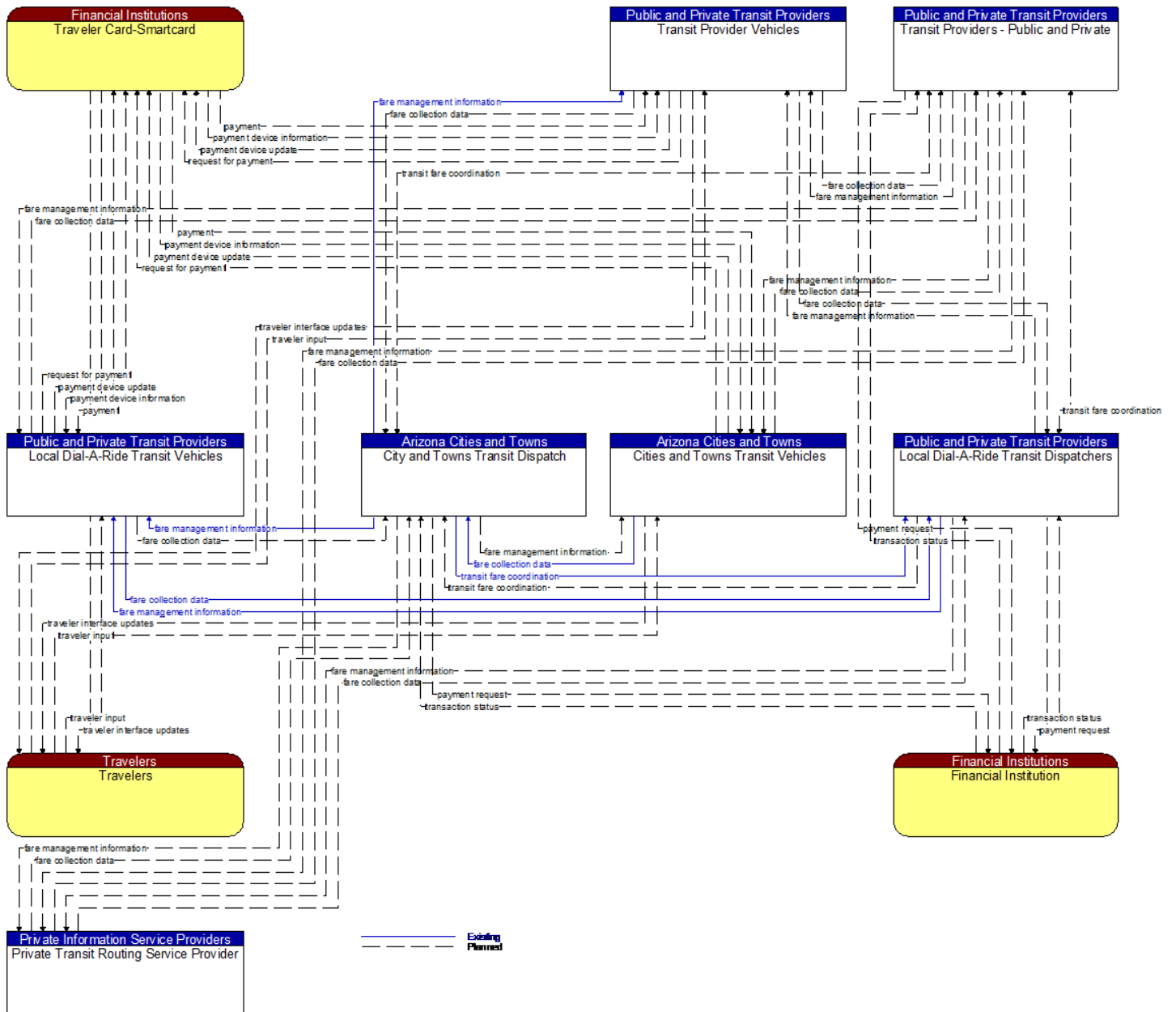

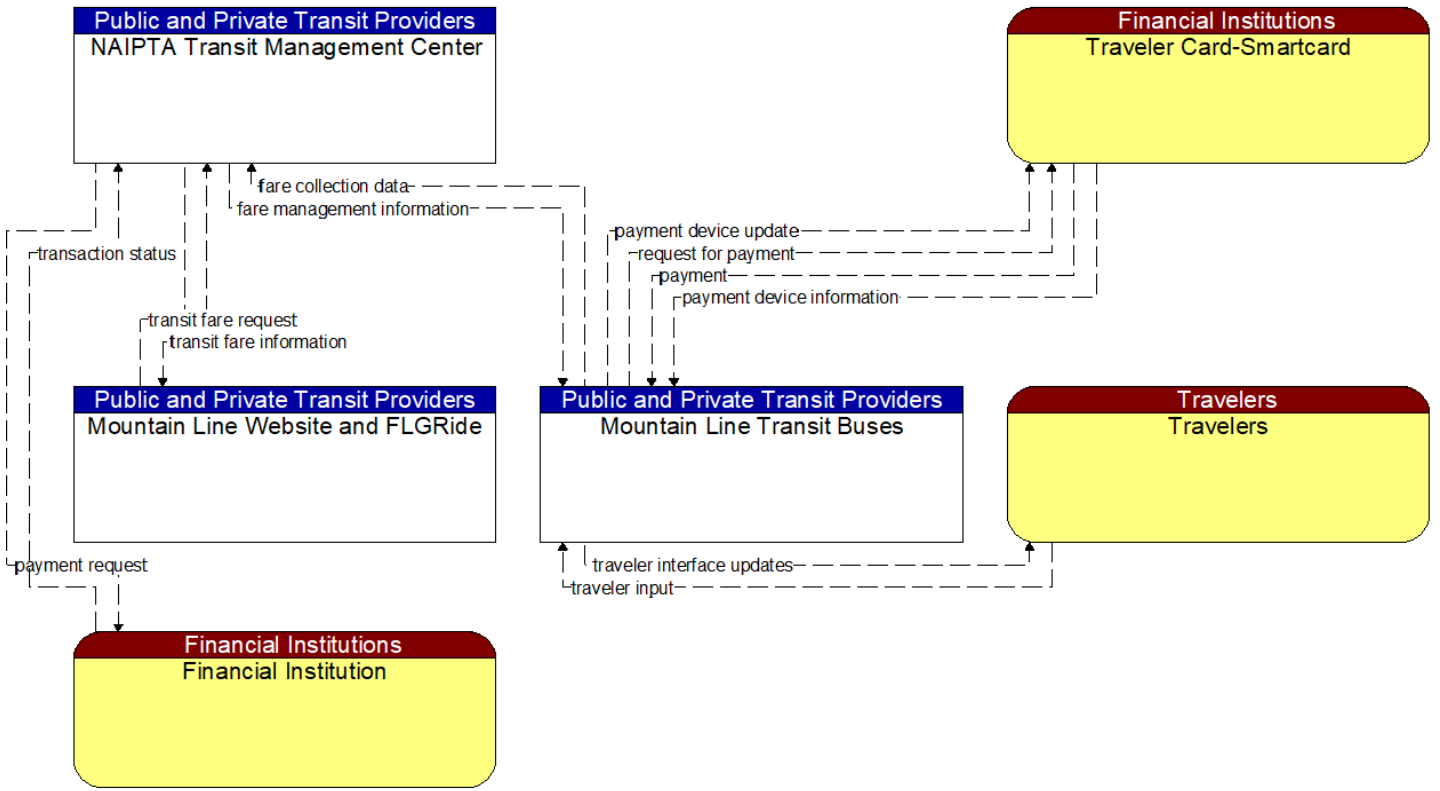

----- Planned

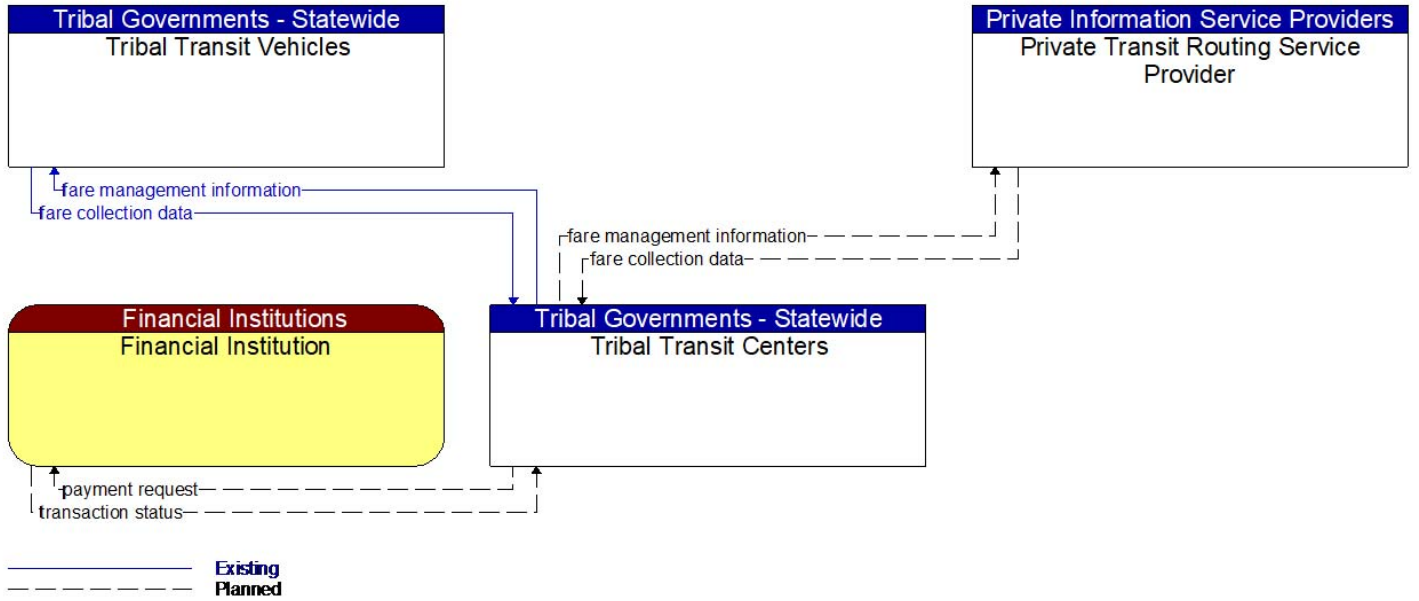



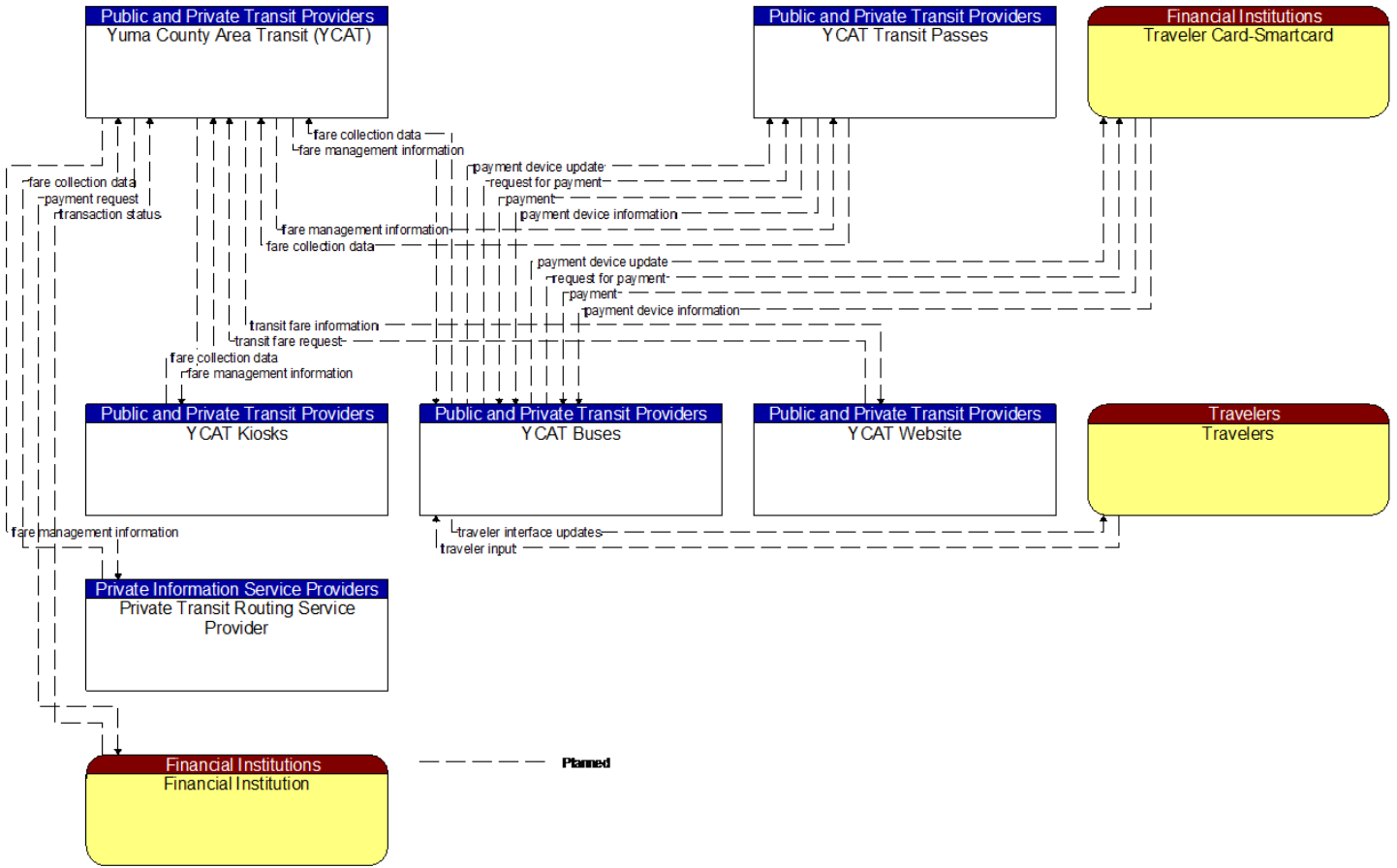

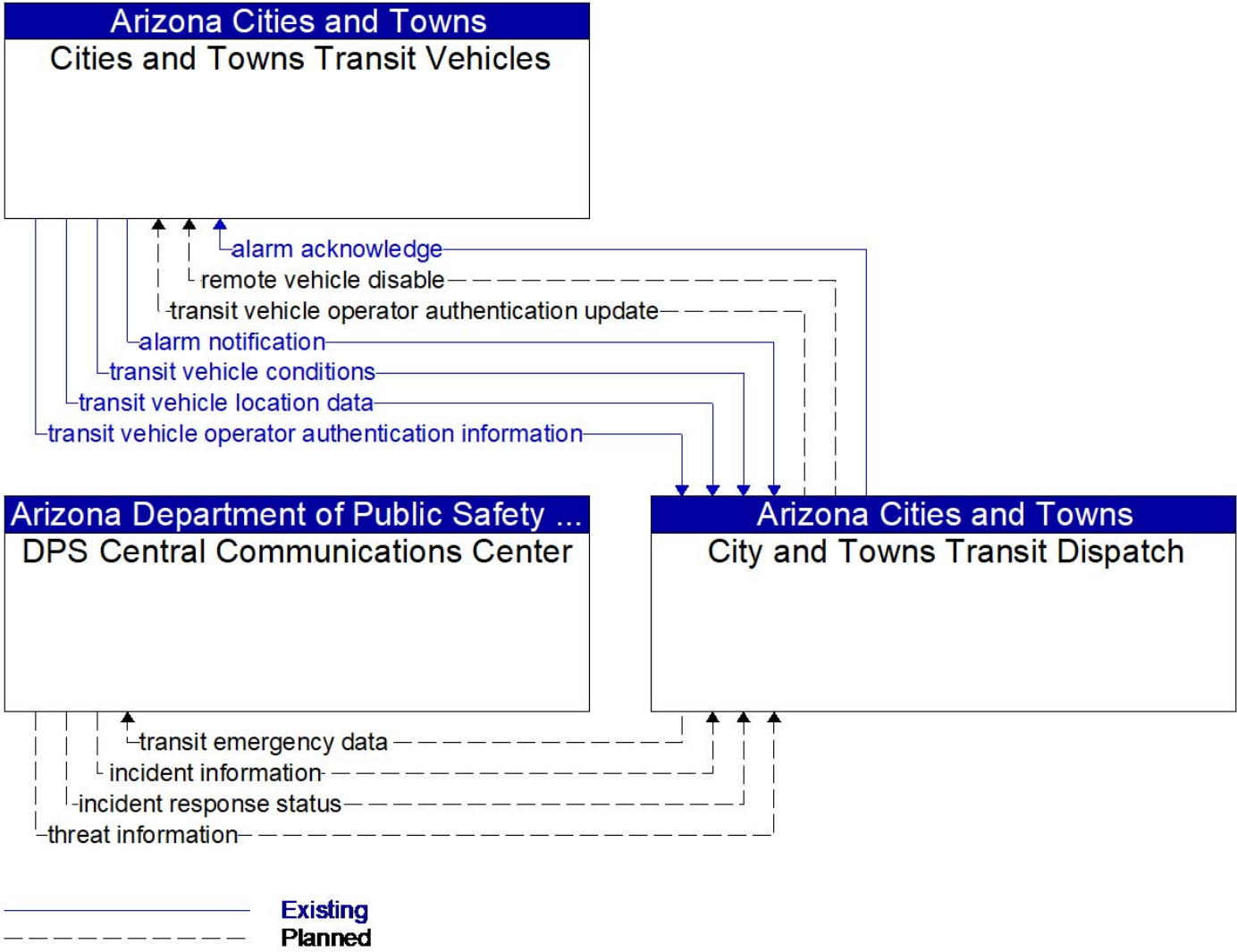

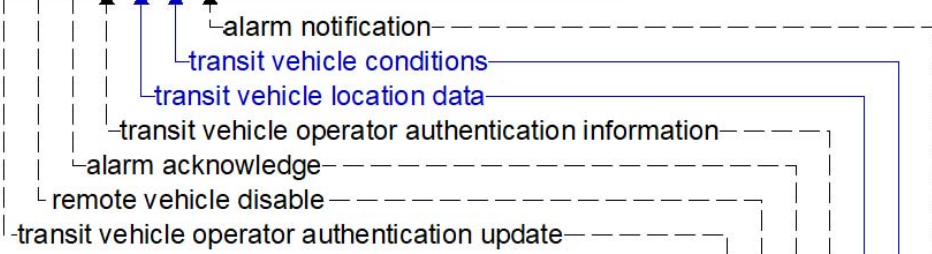
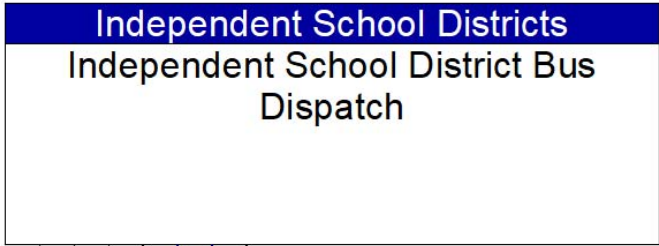

———— Existing  
----- Planned

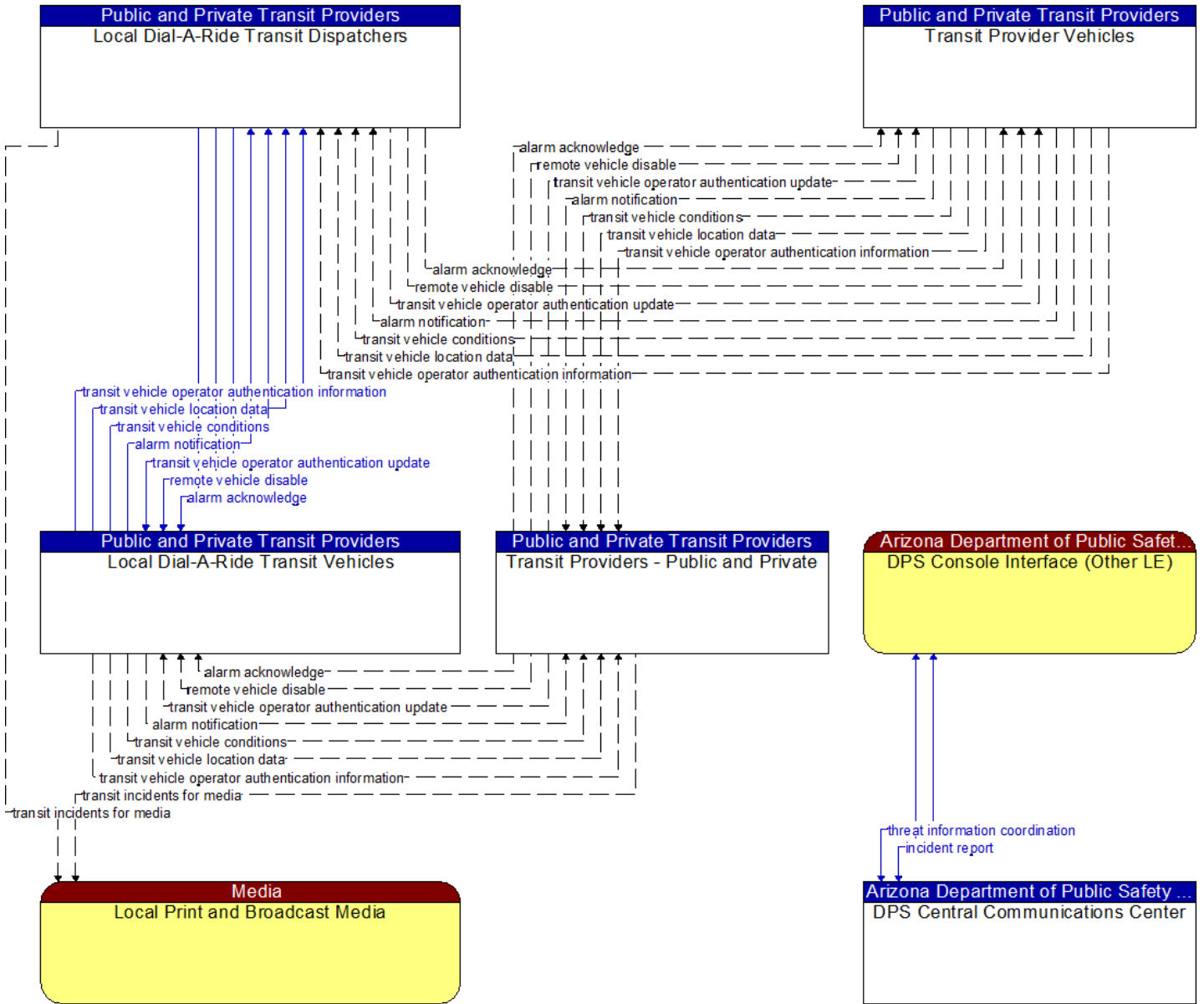

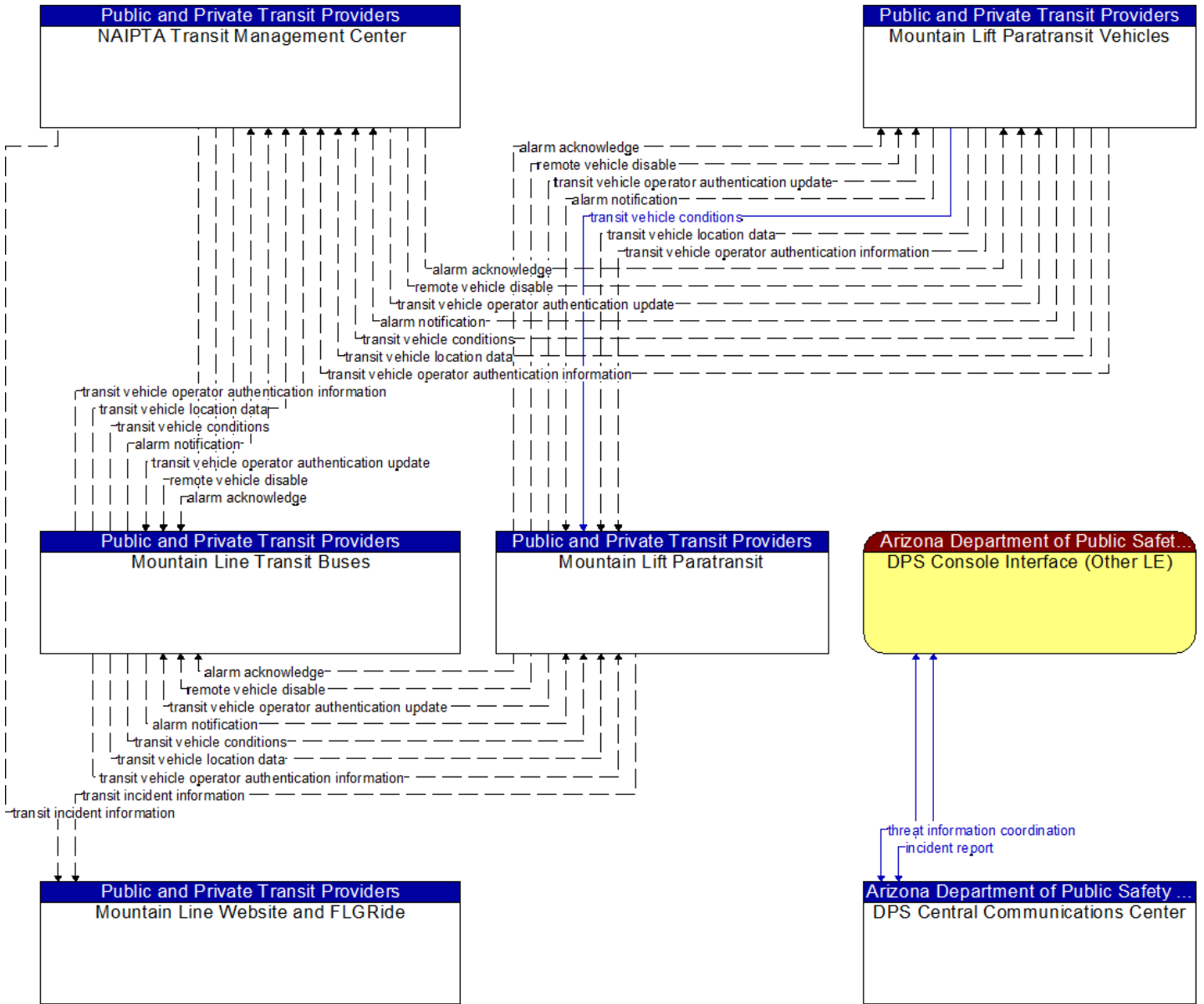

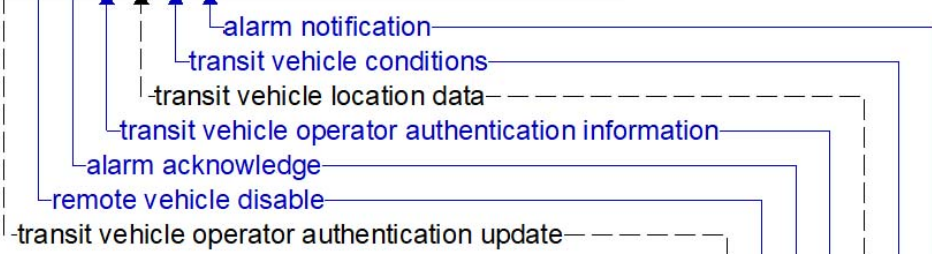
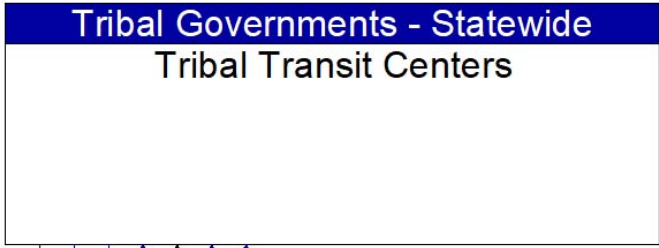

———— Existing  
----- Planned

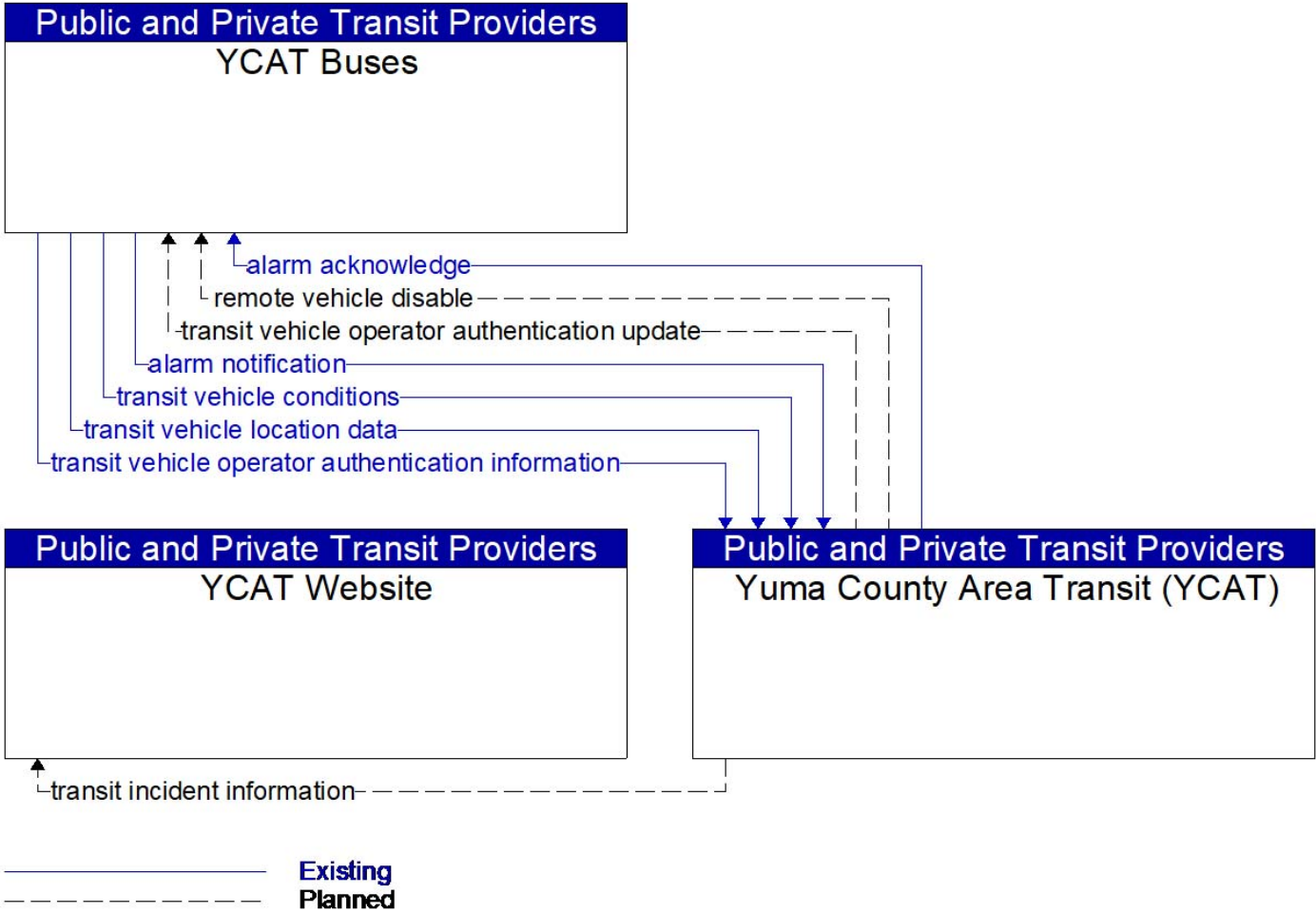

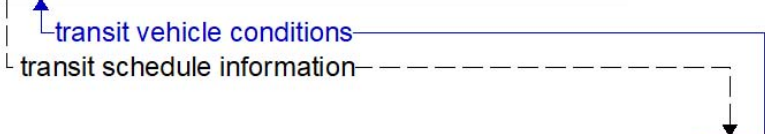
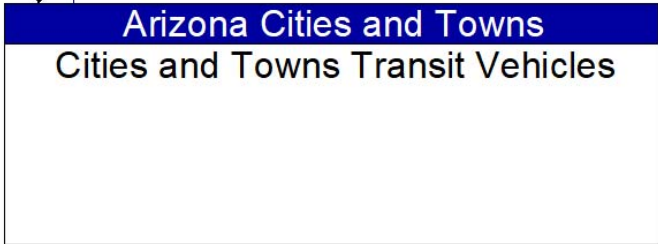
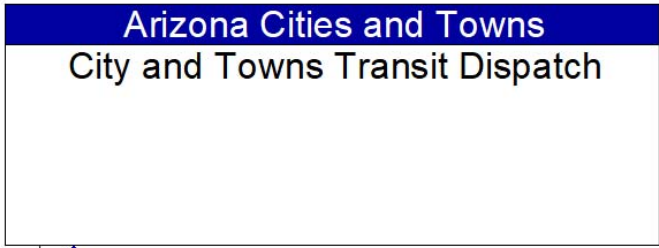

———— Existing  
----- Planned



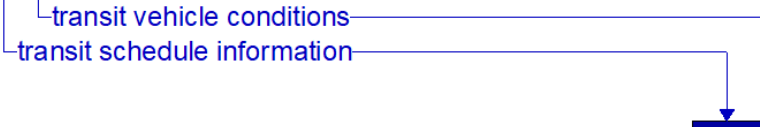
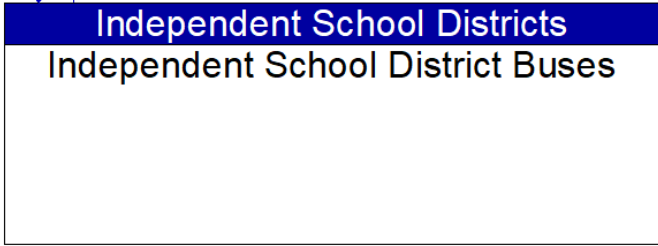
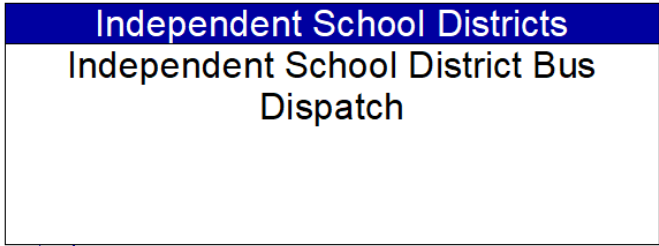

Existing

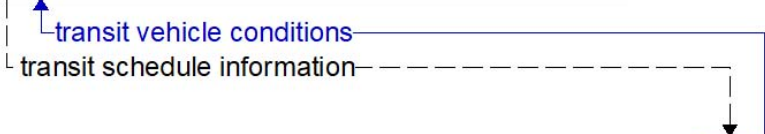
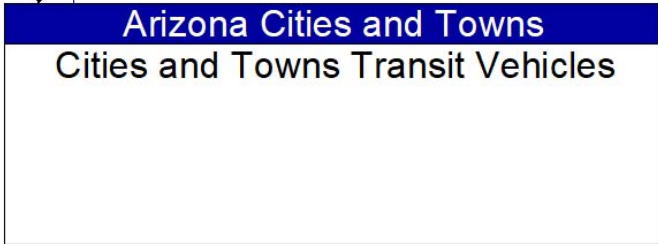
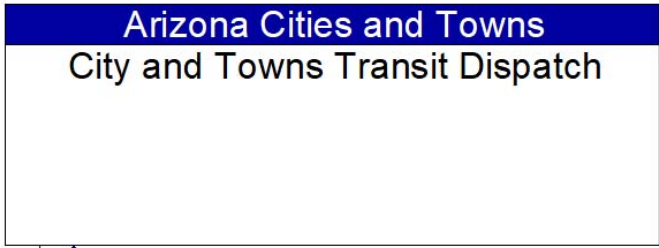

———— Existing  
----- Planned

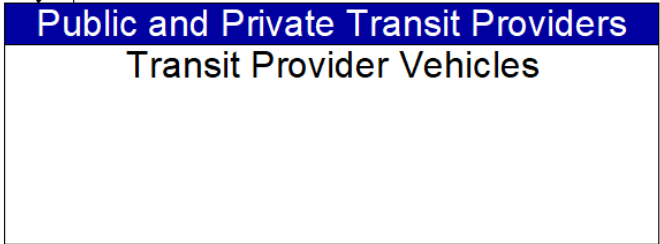
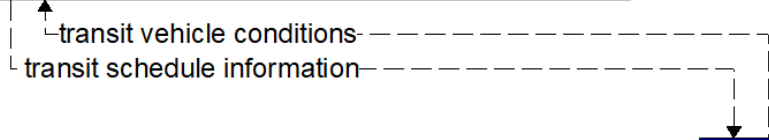
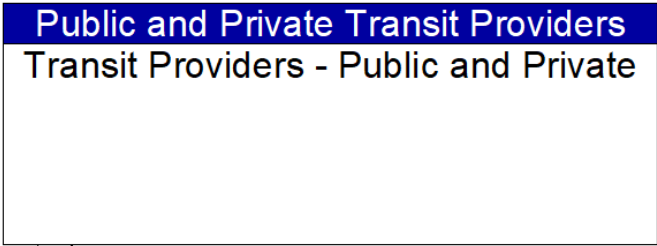

----- **Planned**

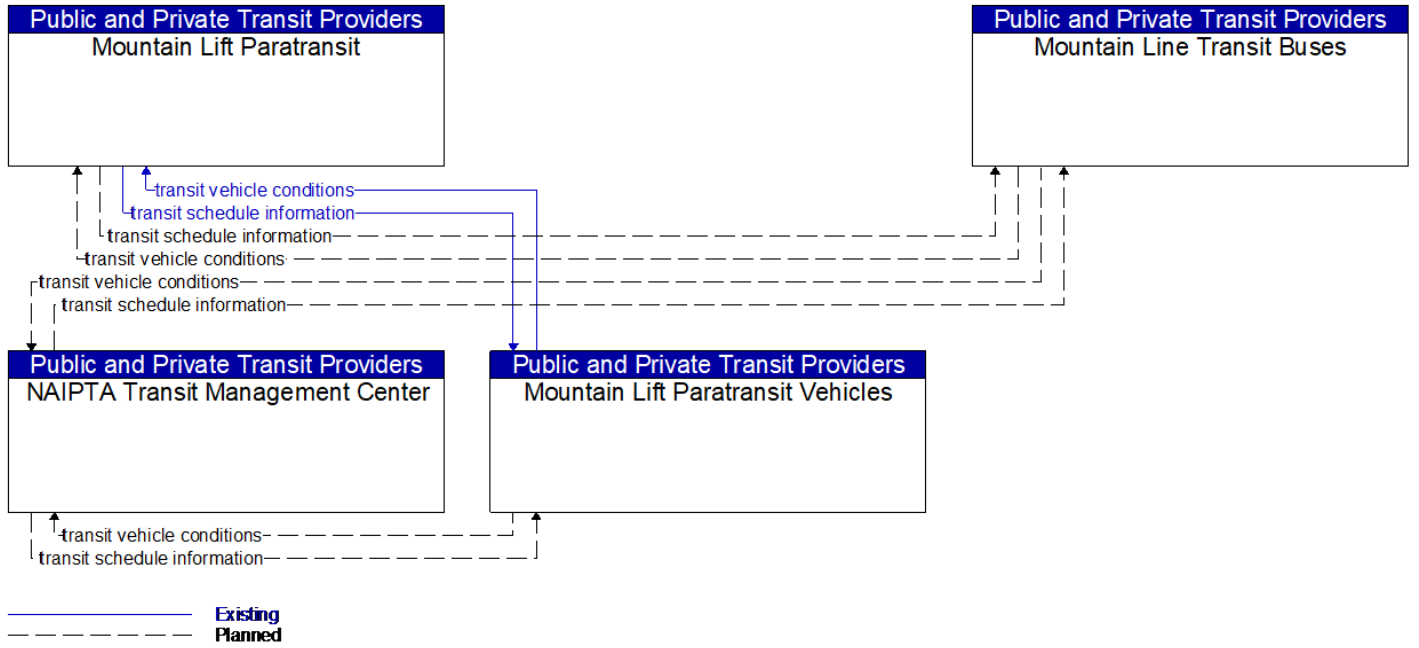

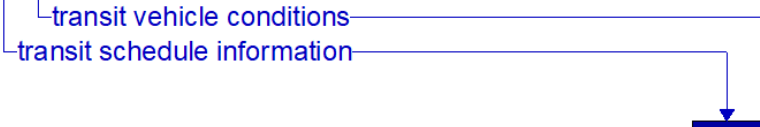
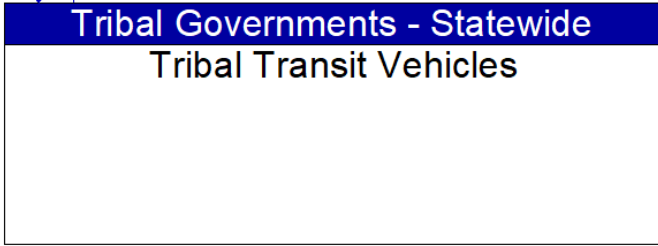

Existing

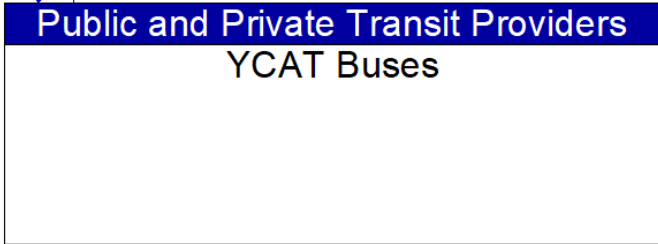
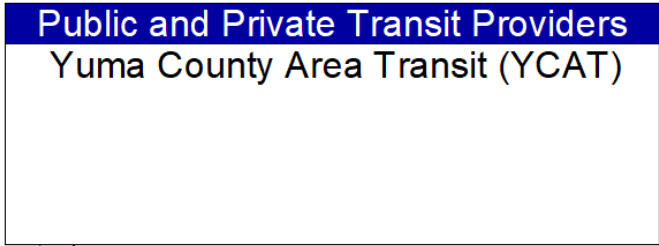

Existing

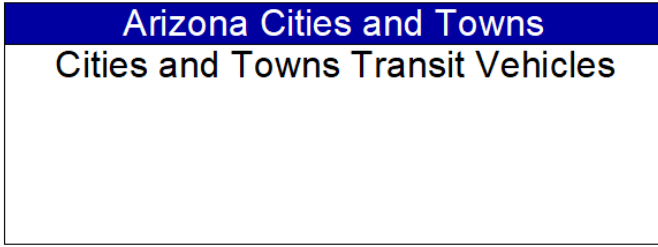
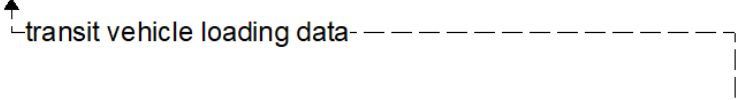
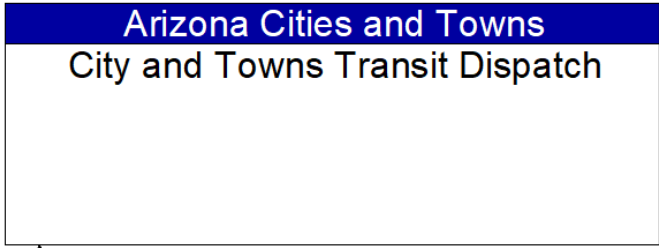

----- **Planned**

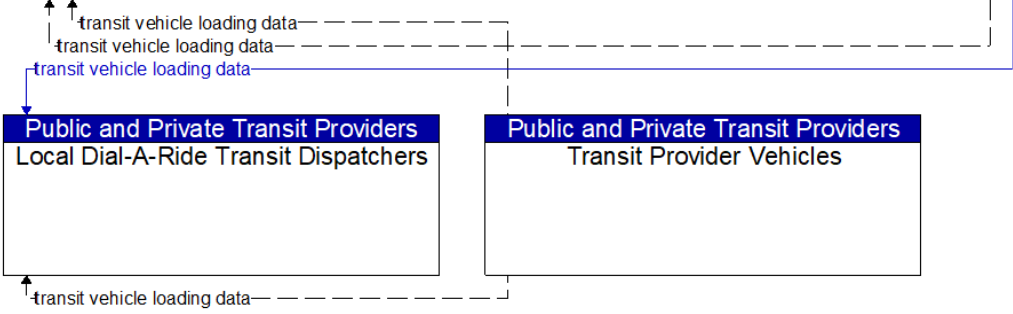
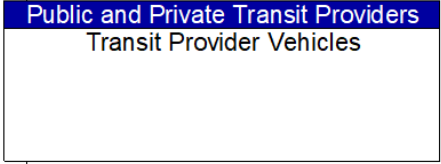
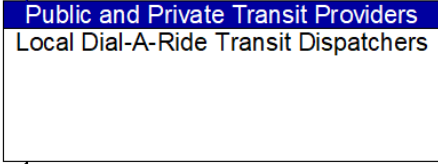
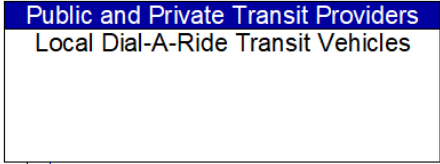
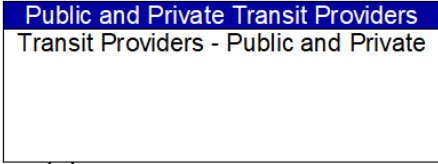

———— Existing  
----- Planned



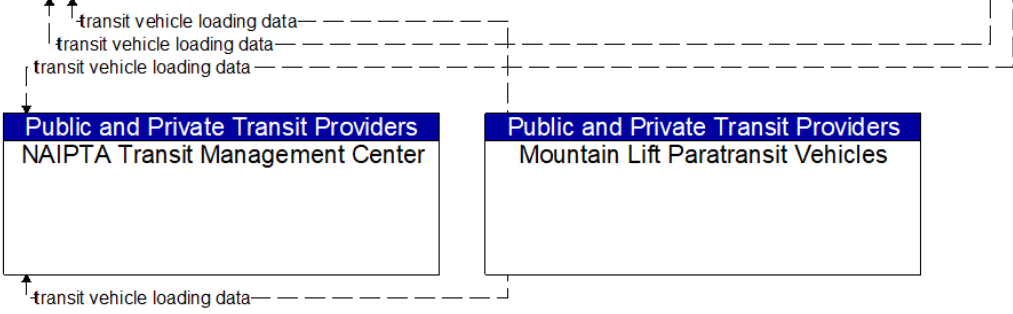
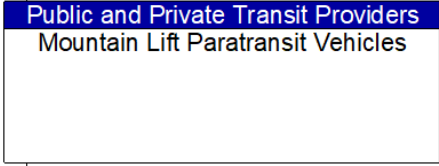
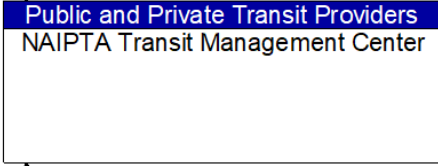
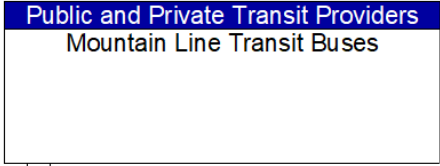
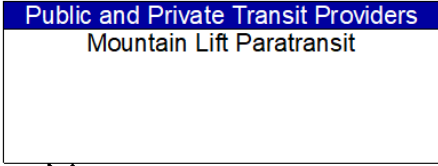

----- **Planned**

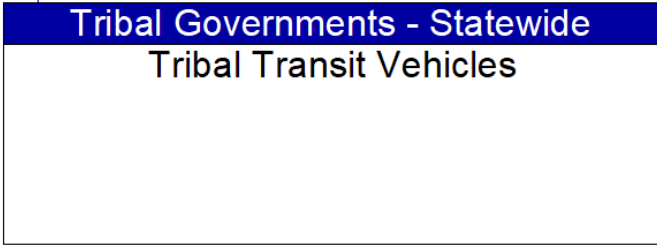
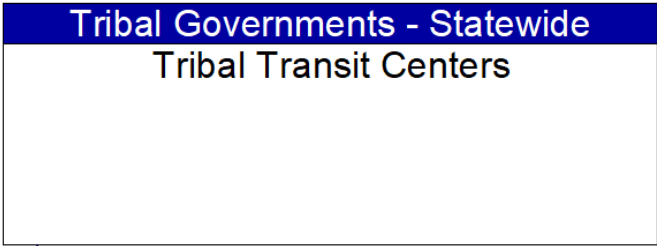

Existing

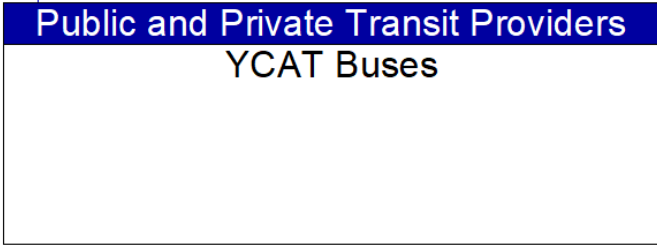
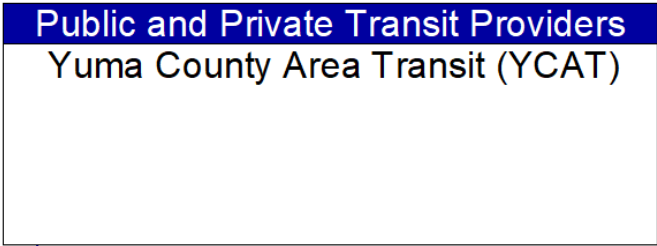

Existing

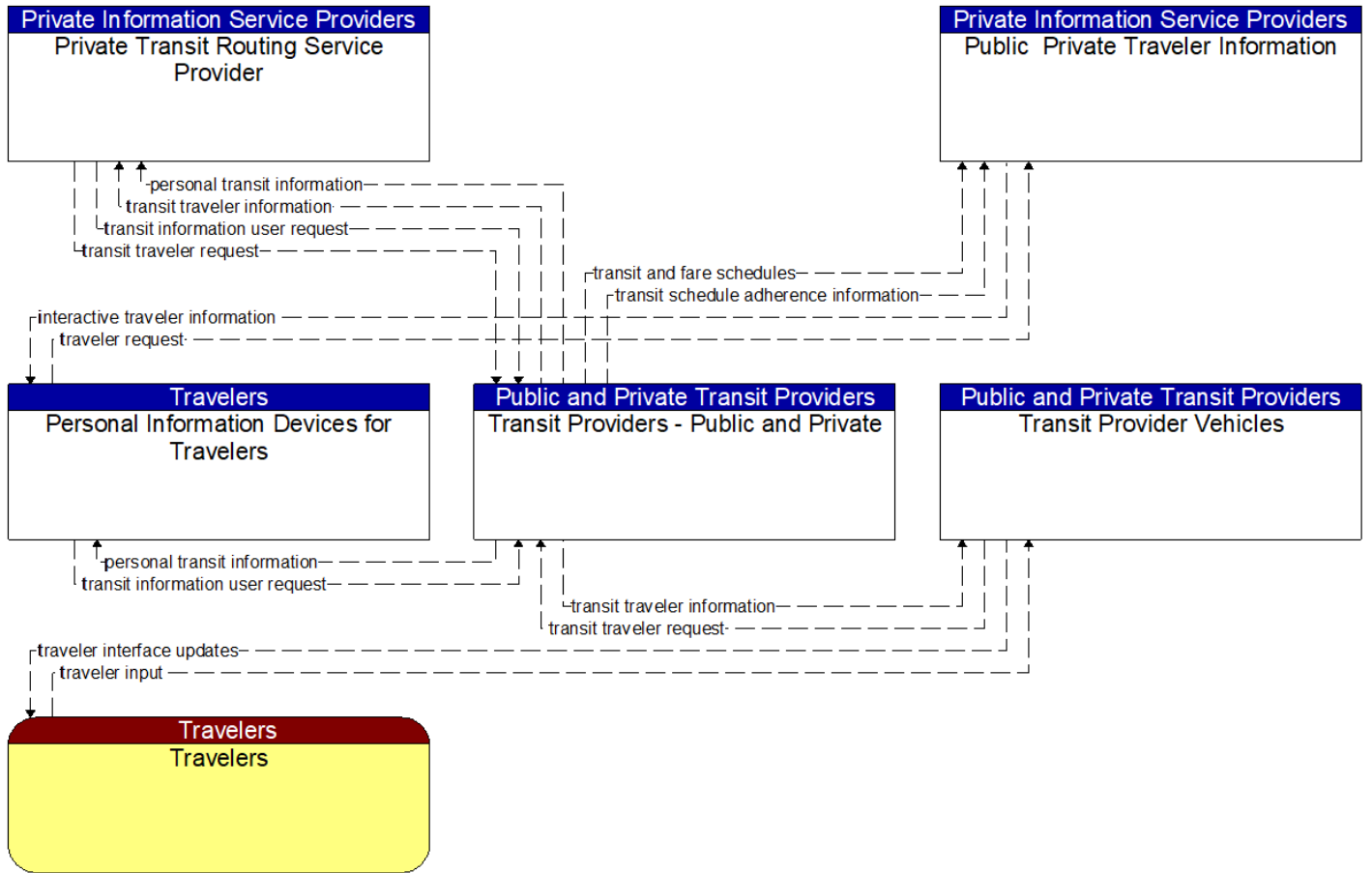

----- Planned

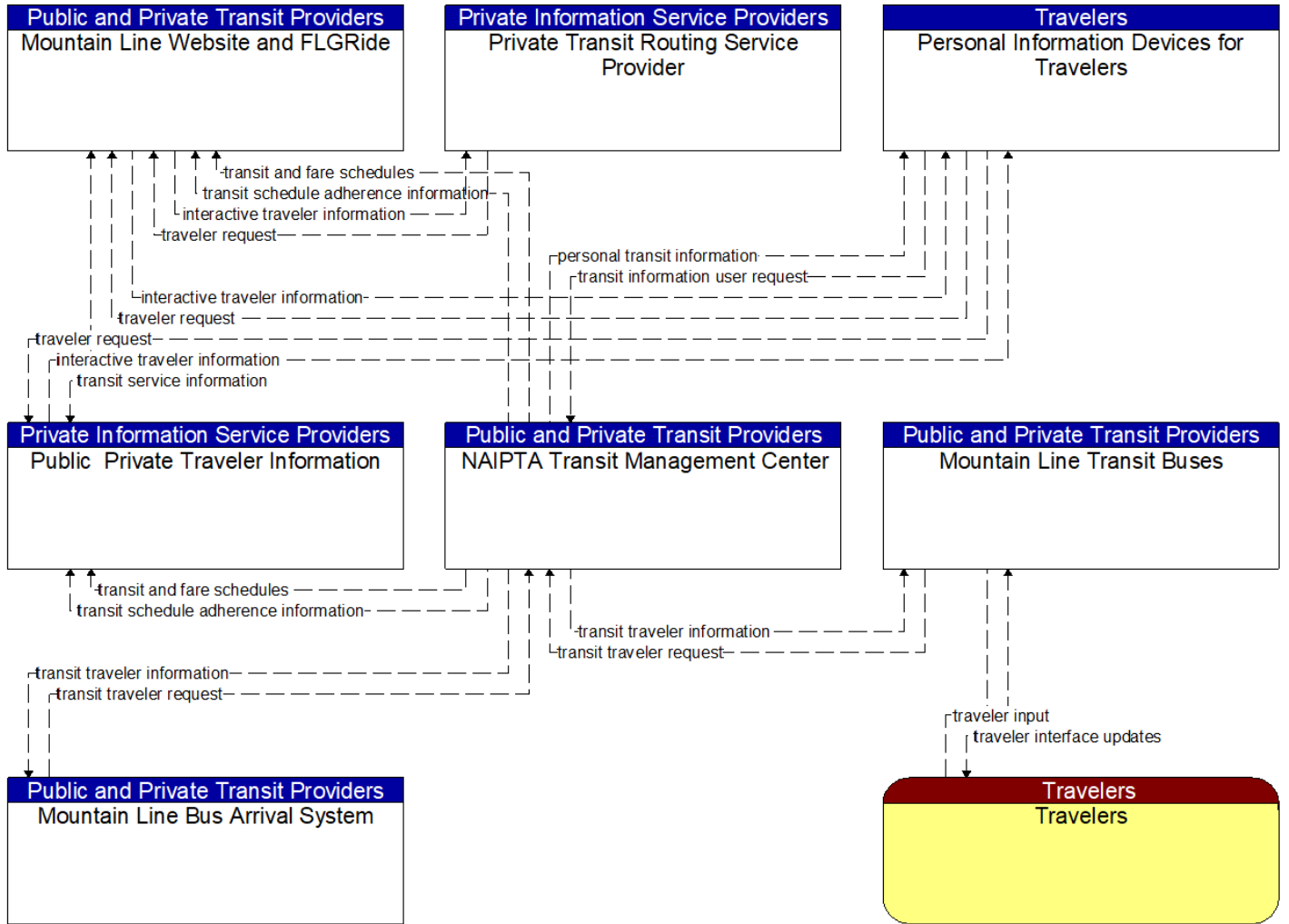

----- Planned

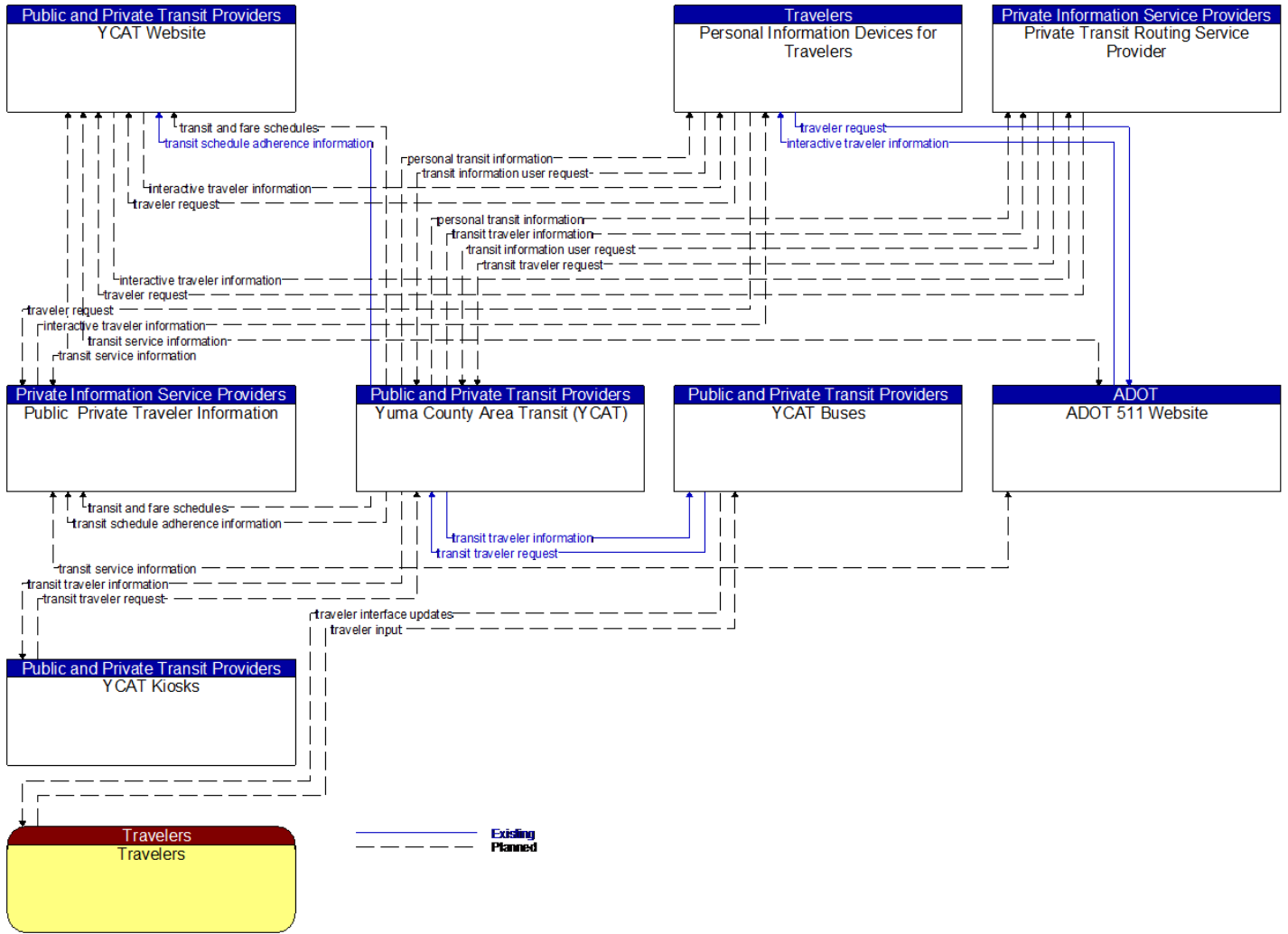

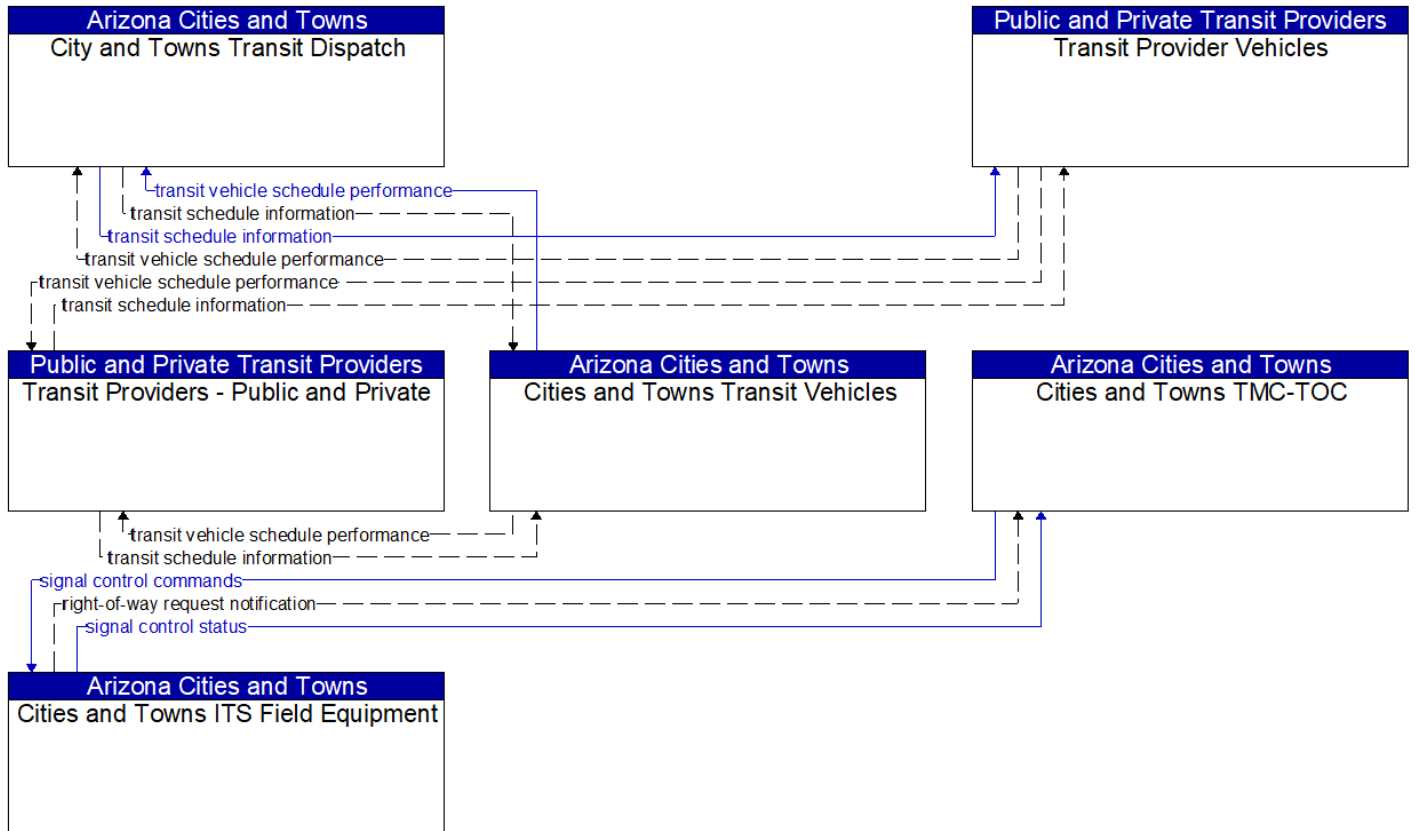

————— Existing  
 - - - - - Planned

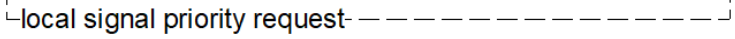
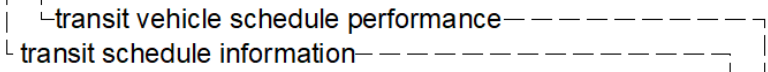
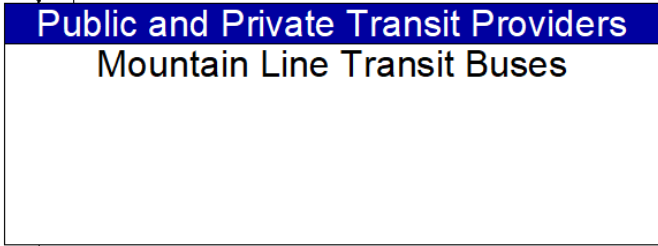
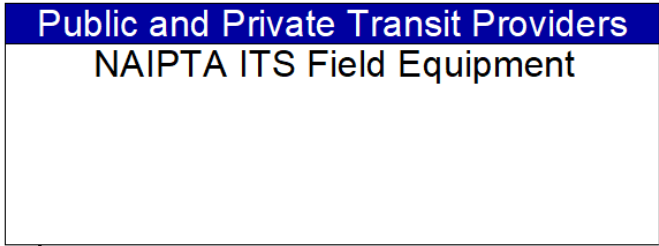

----- **Planned**



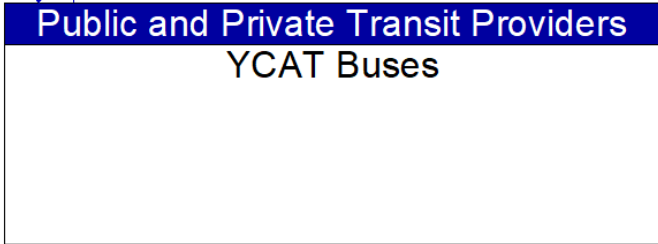
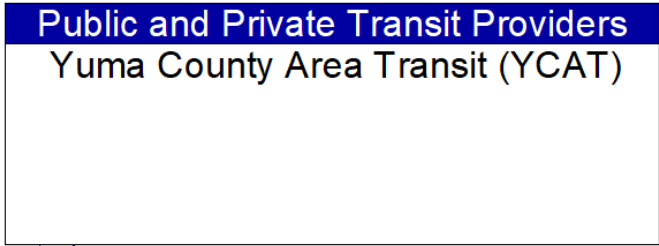

Existing

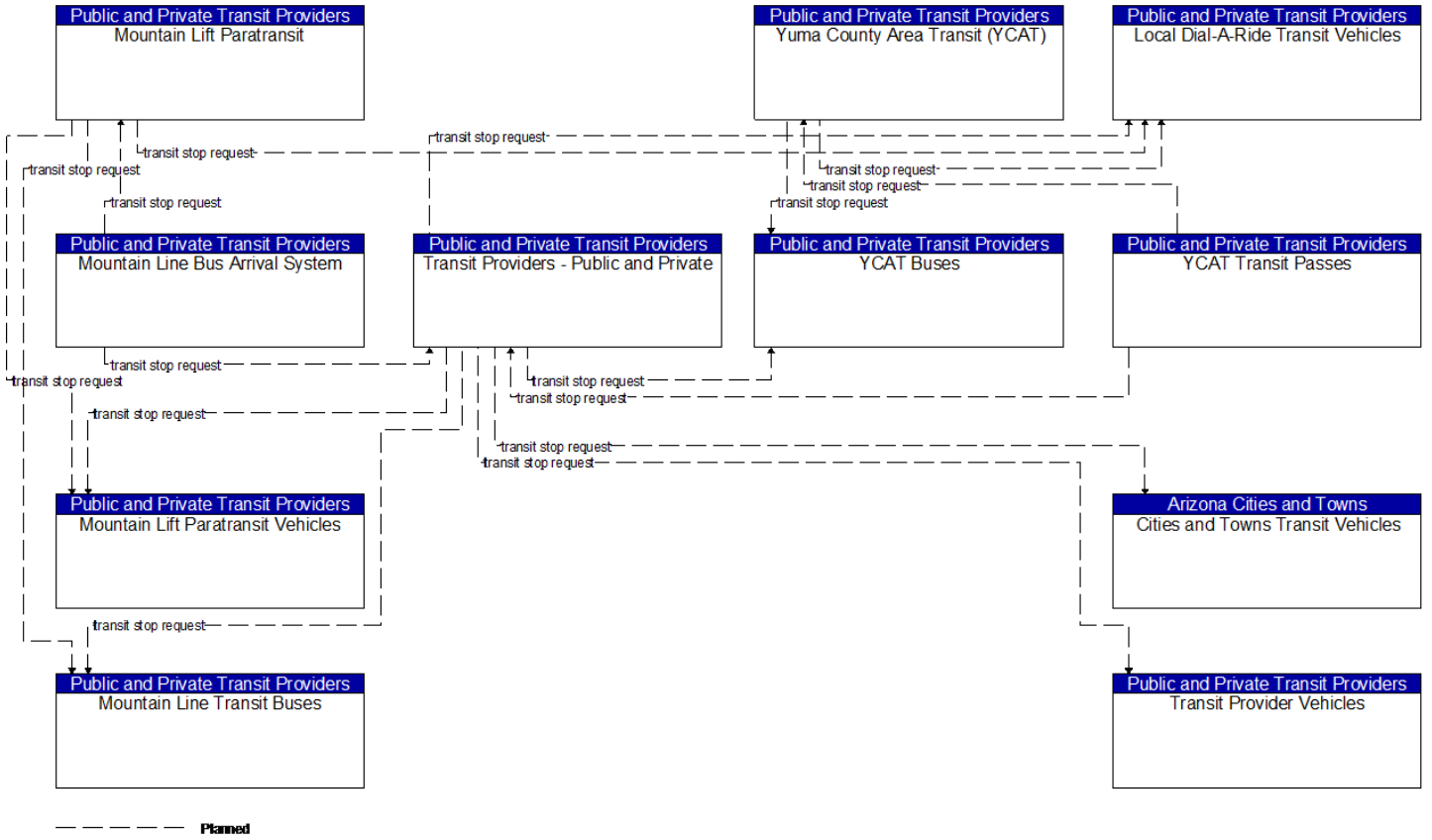

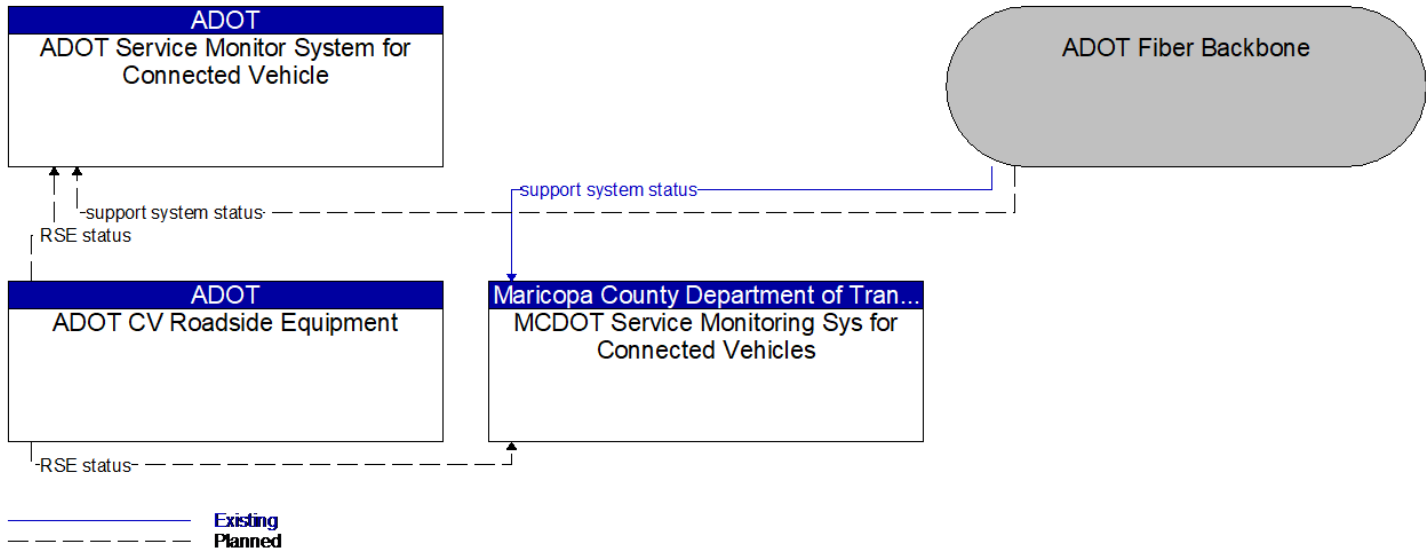

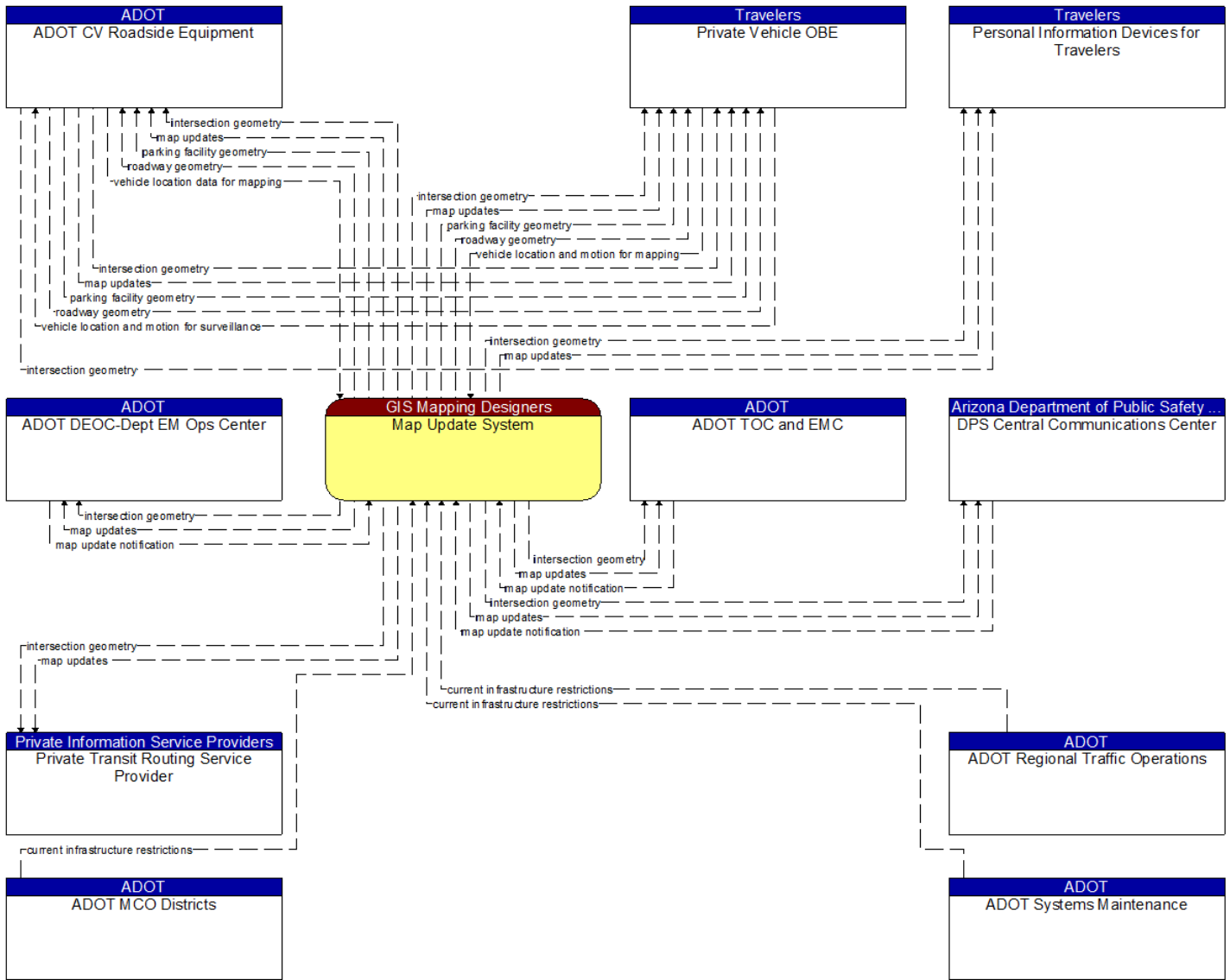

----- Planned

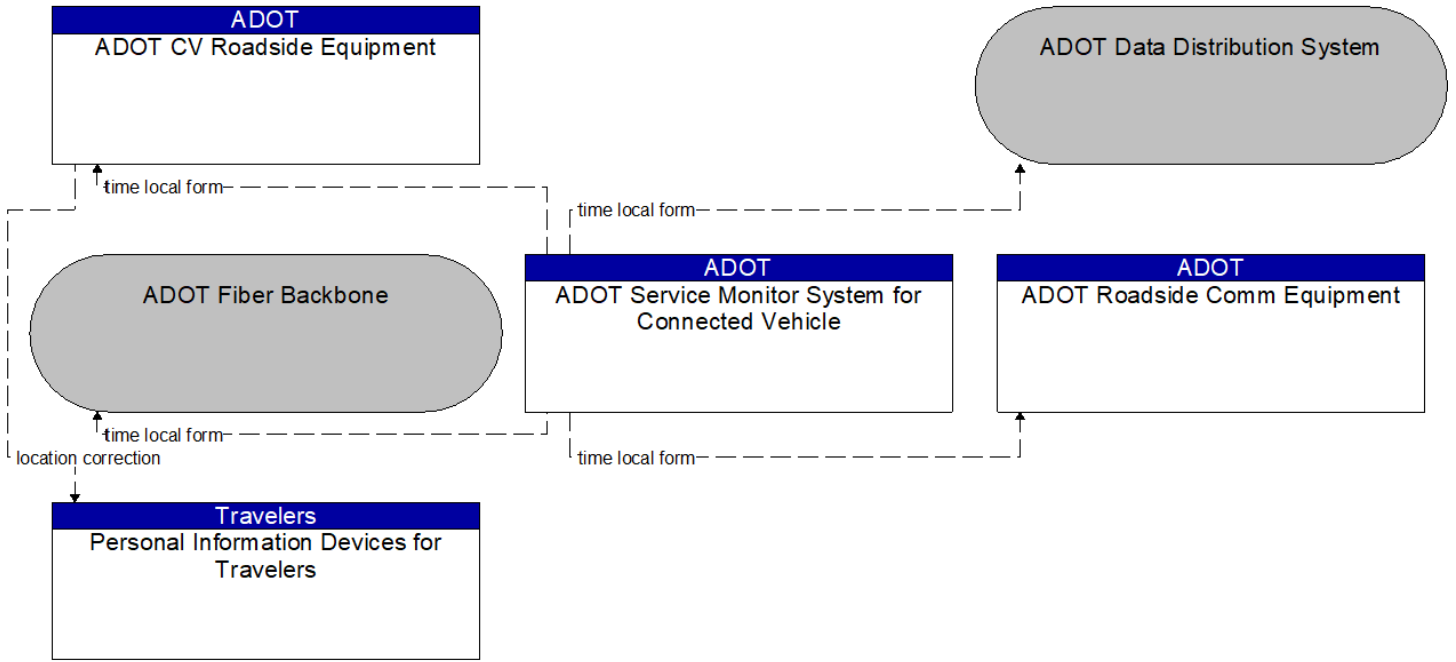

----- Planned



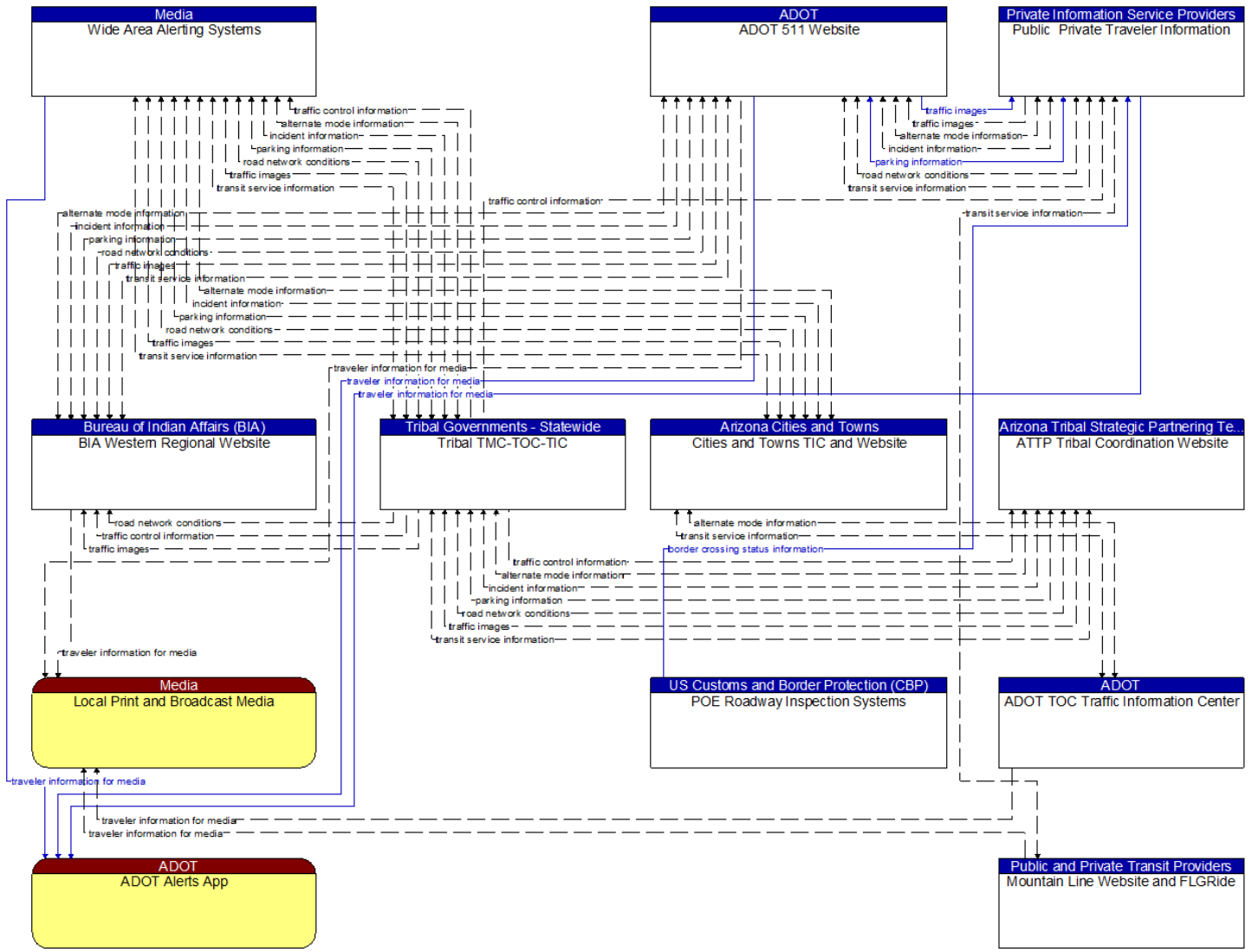

————— Existing  
 - - - - - Planned

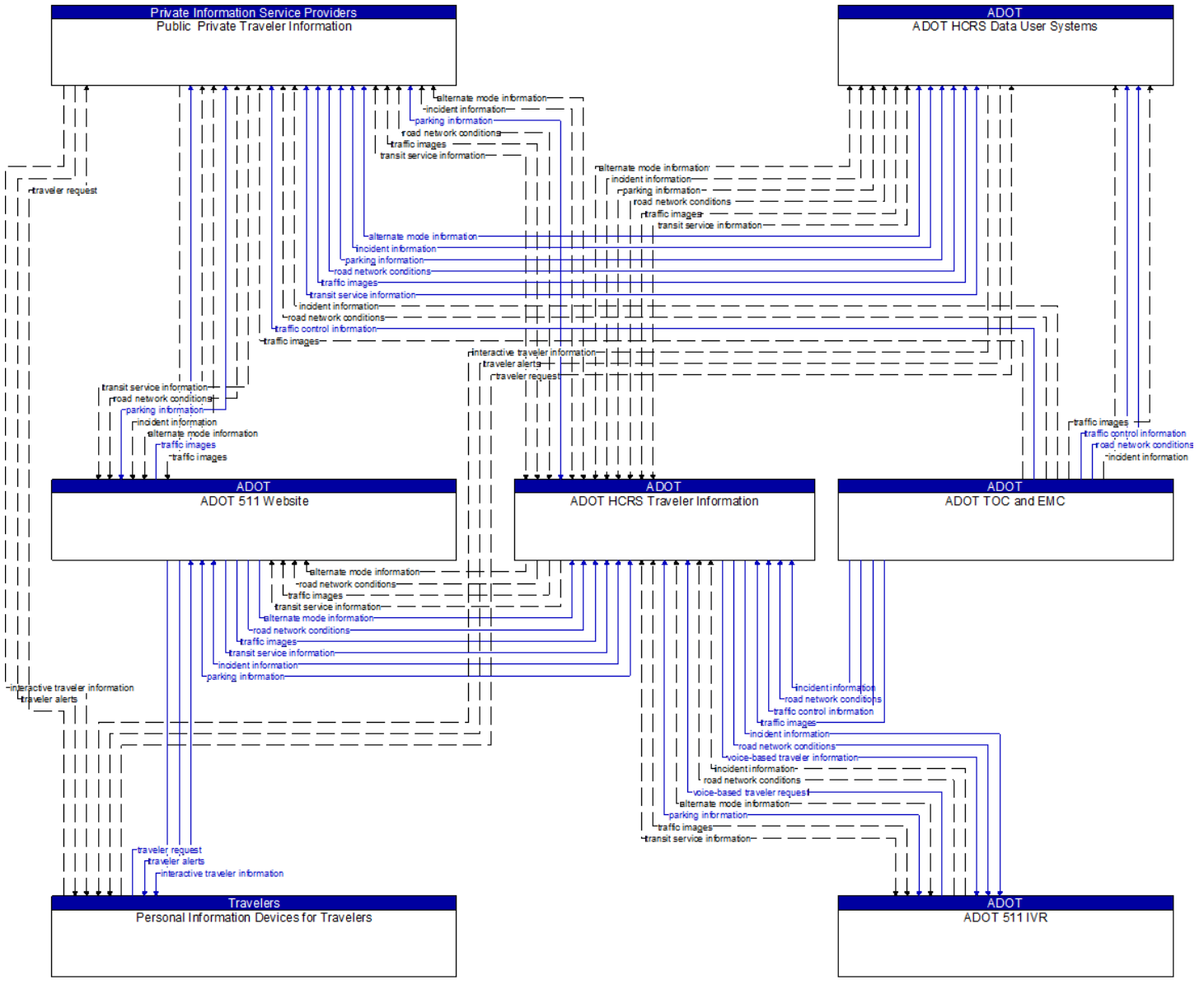

— Existing  
 - - - Planned



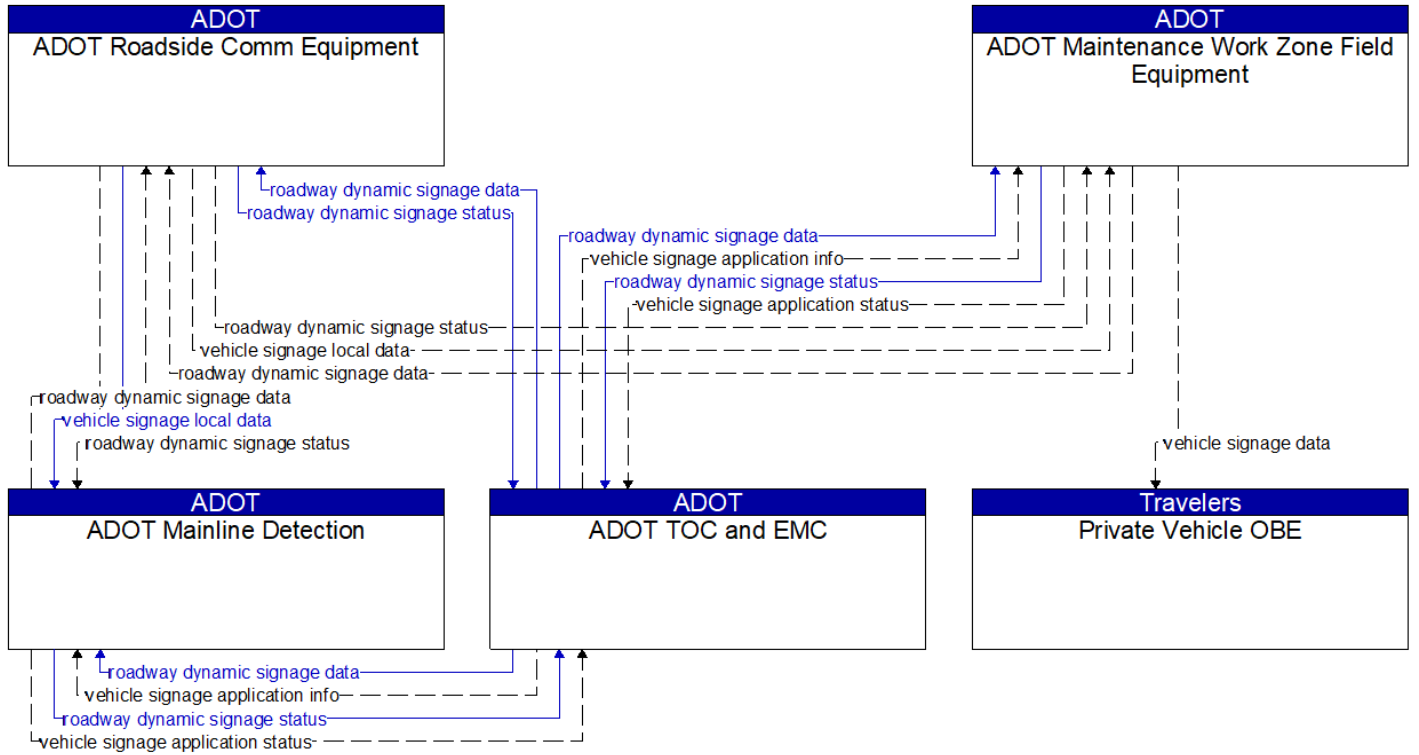

Existing  
 Planned



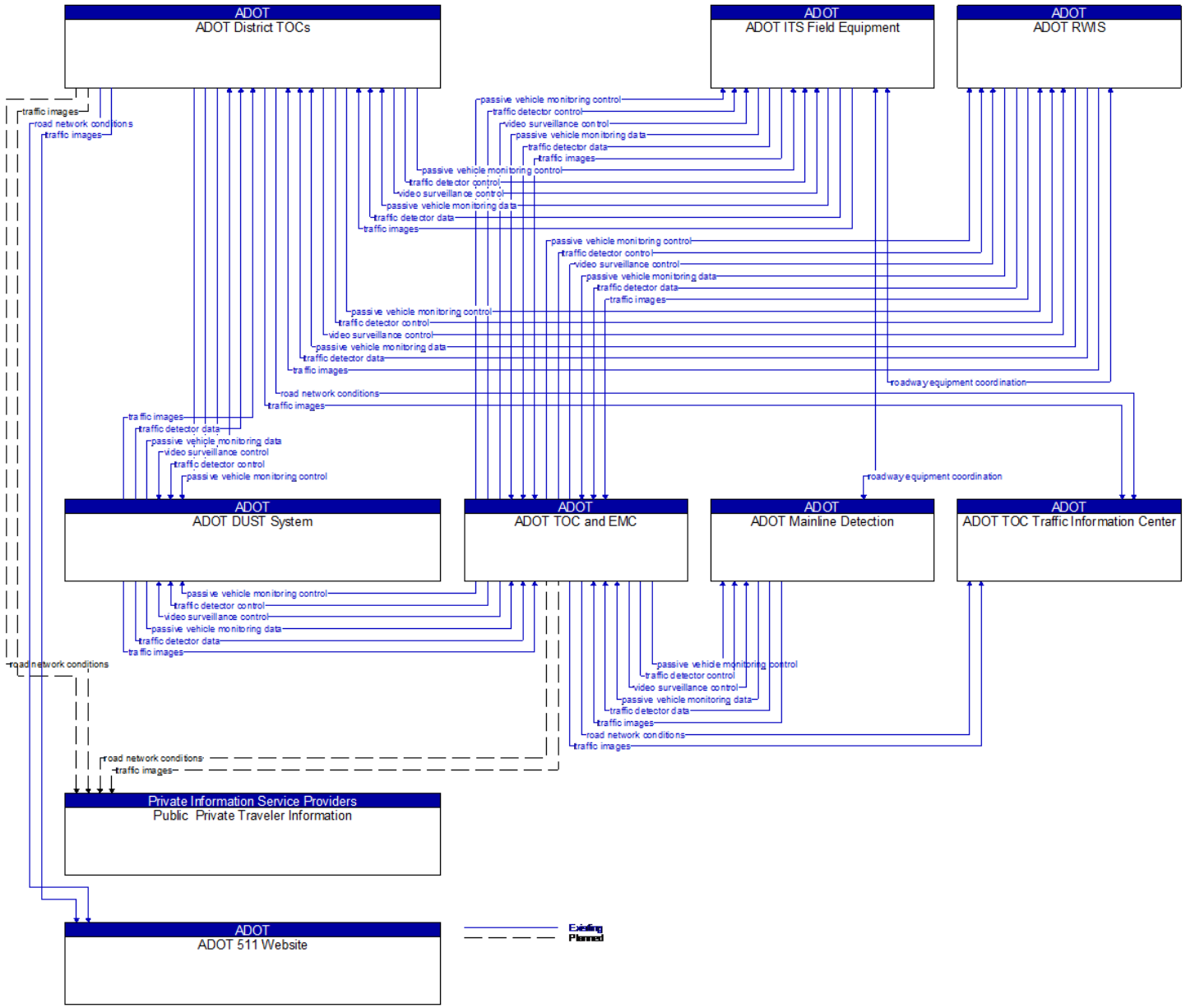

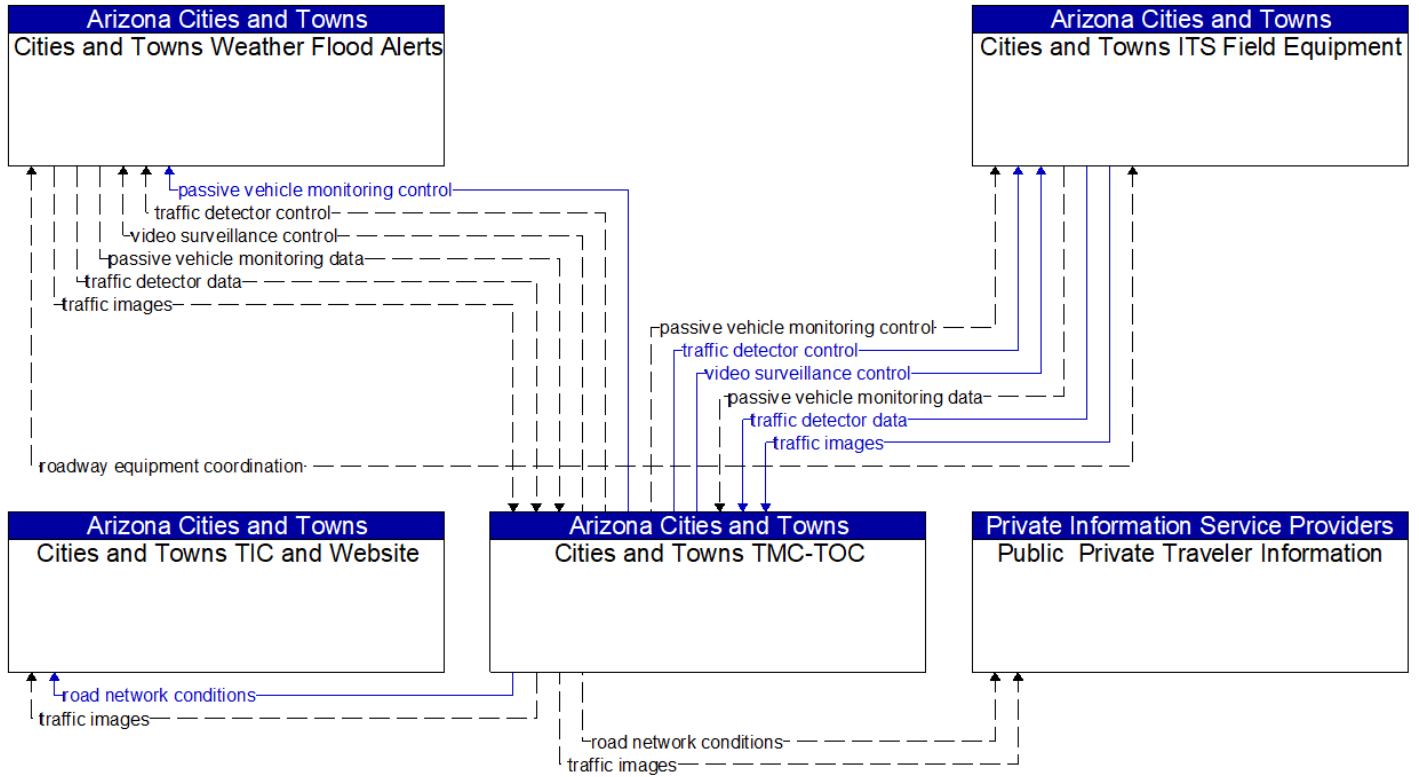

— Existing  
 - - - Planned

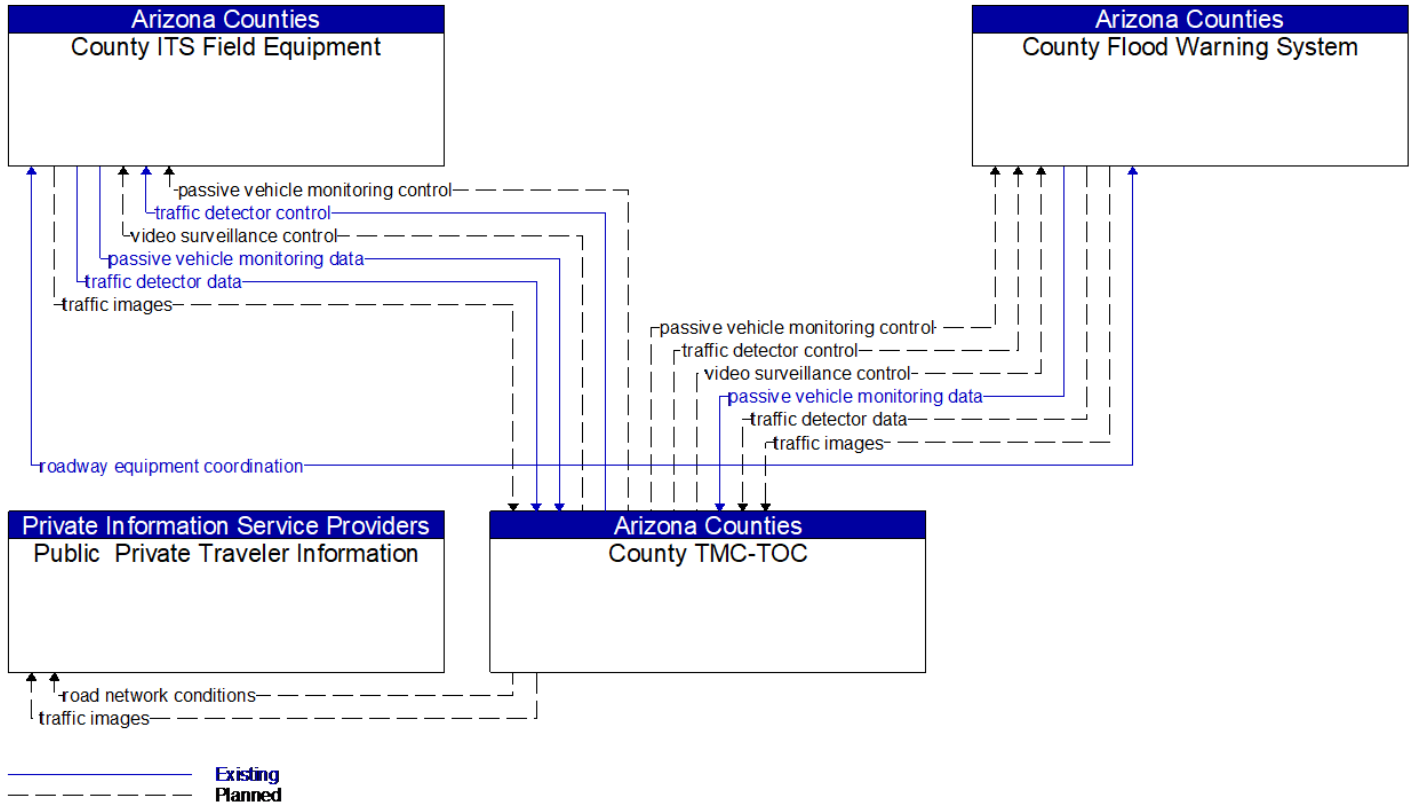

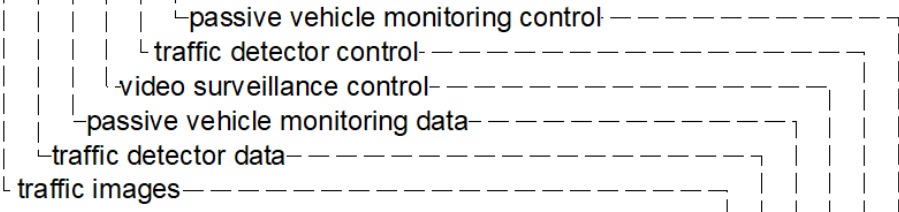
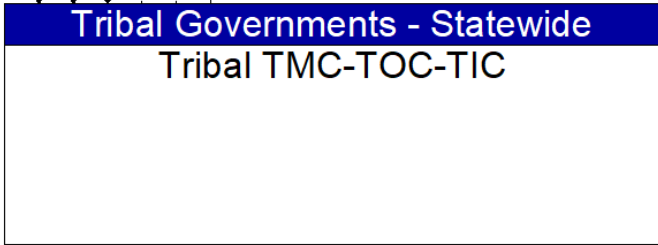
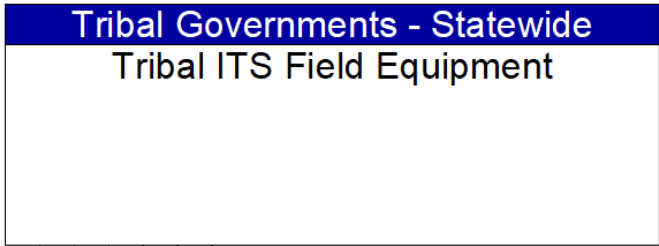

----- **Planned**

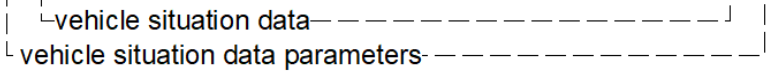
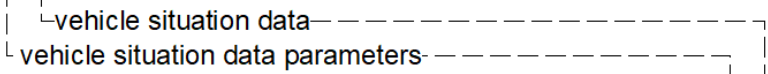
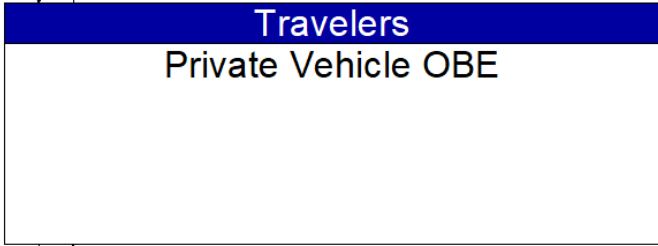
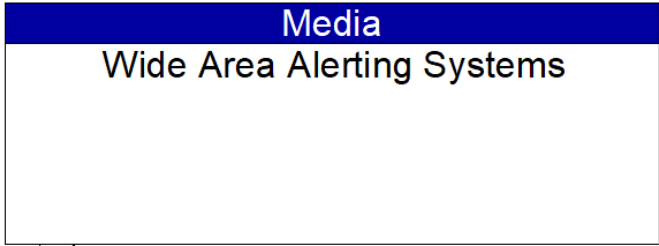
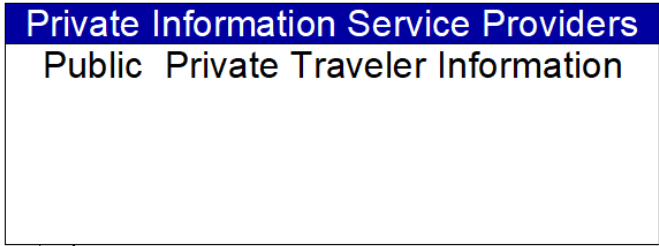

----- **Planned**

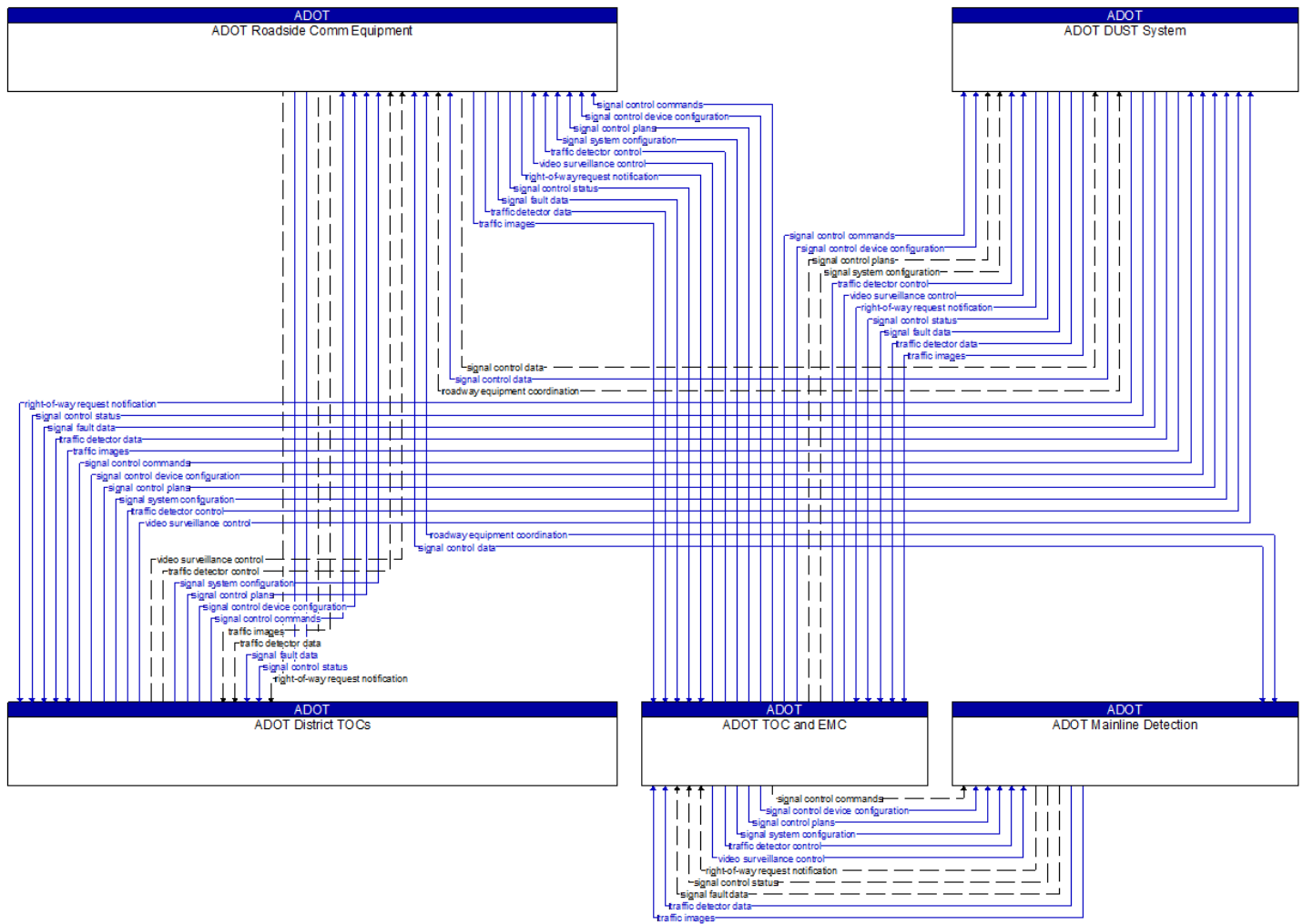

Existing  
 Planned



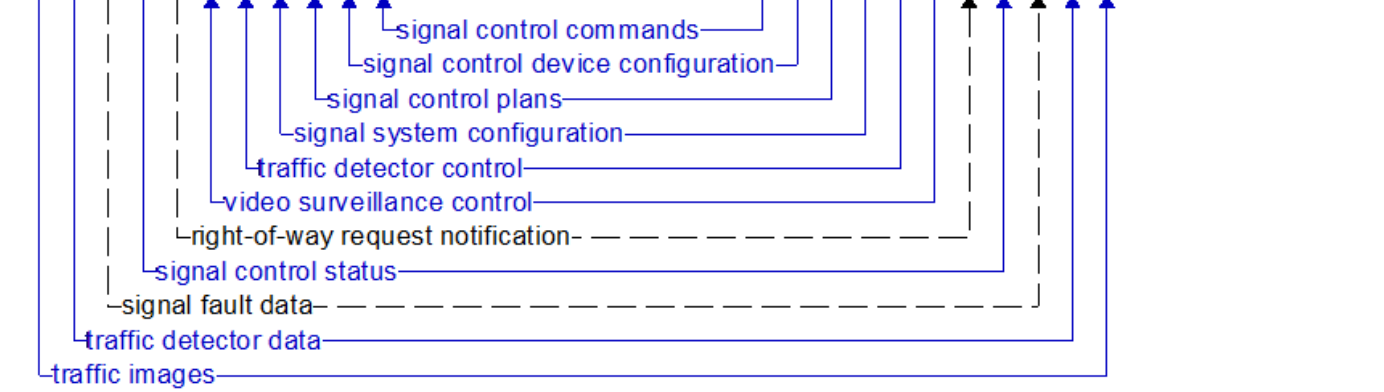
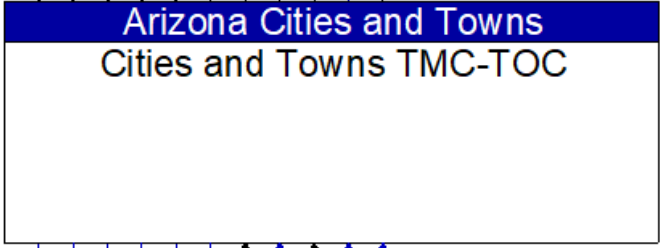
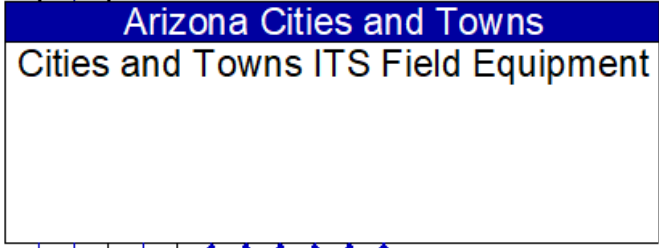
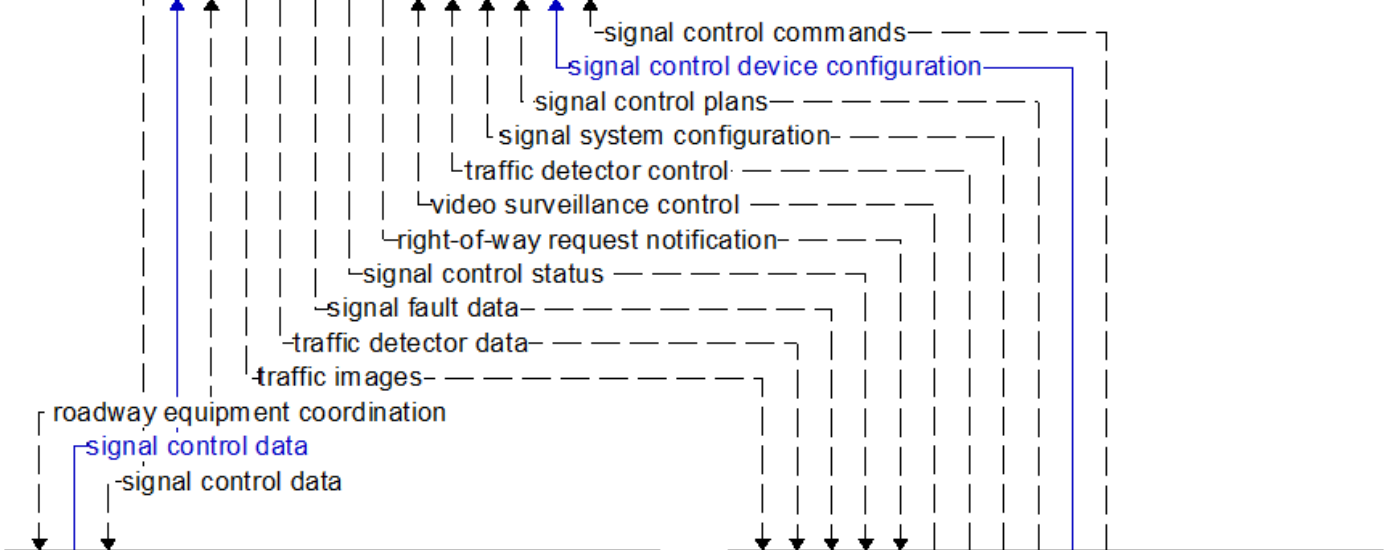
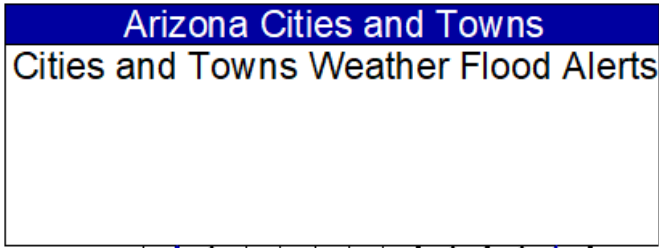

———— Existing  
- - - - - Planned

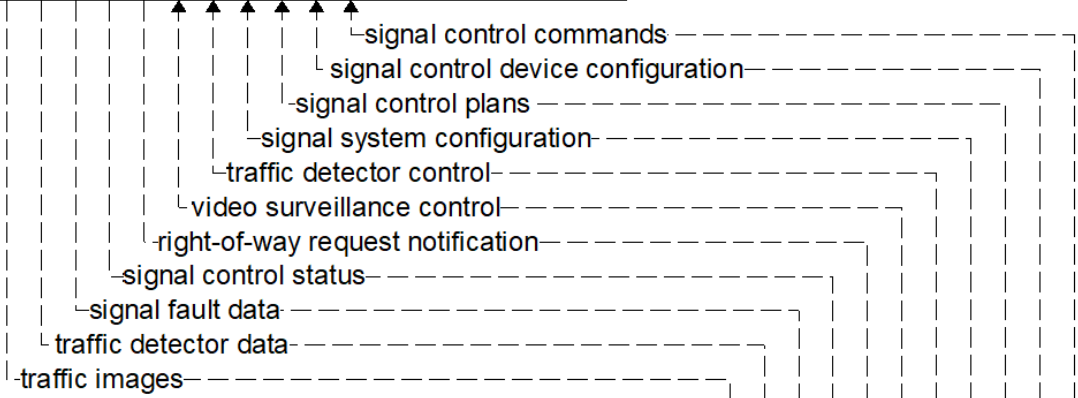
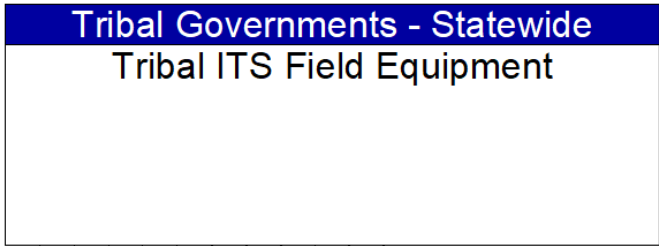

----- **Planned**

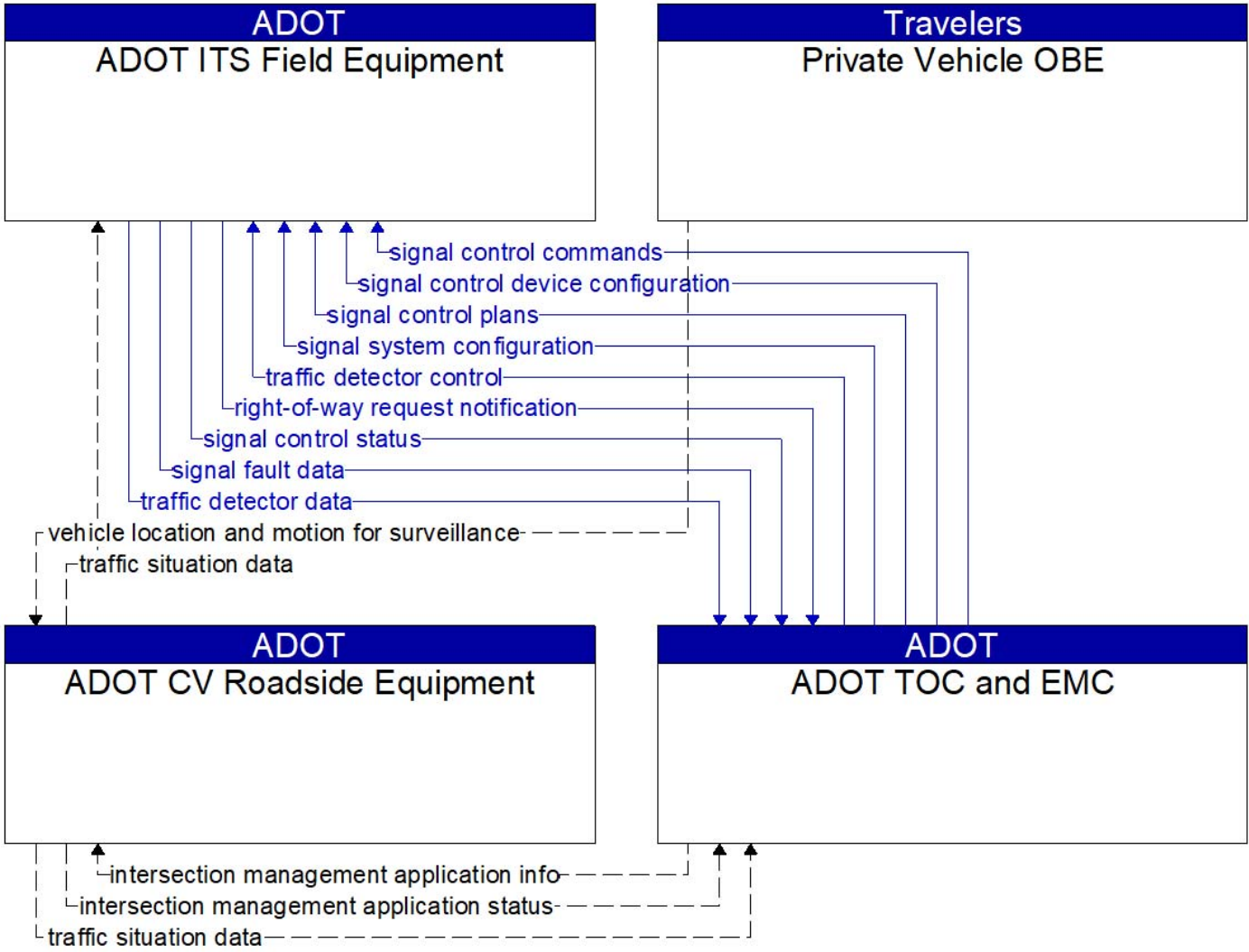

———— Existing  
 - - - - - Planned

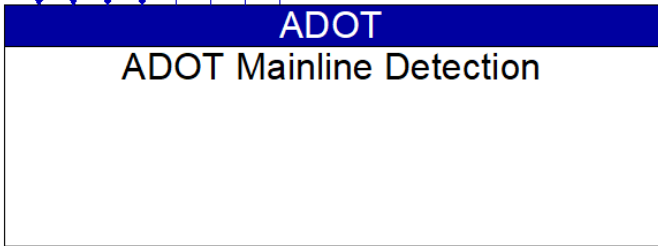
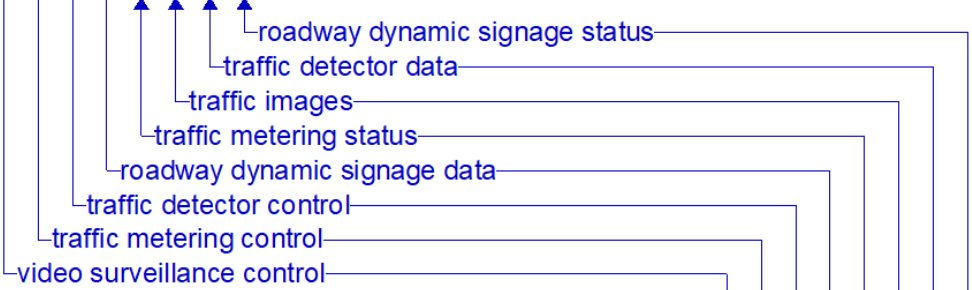
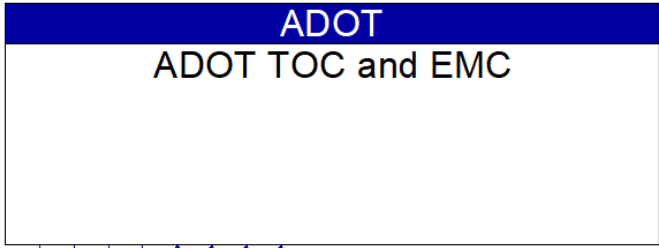

Existing

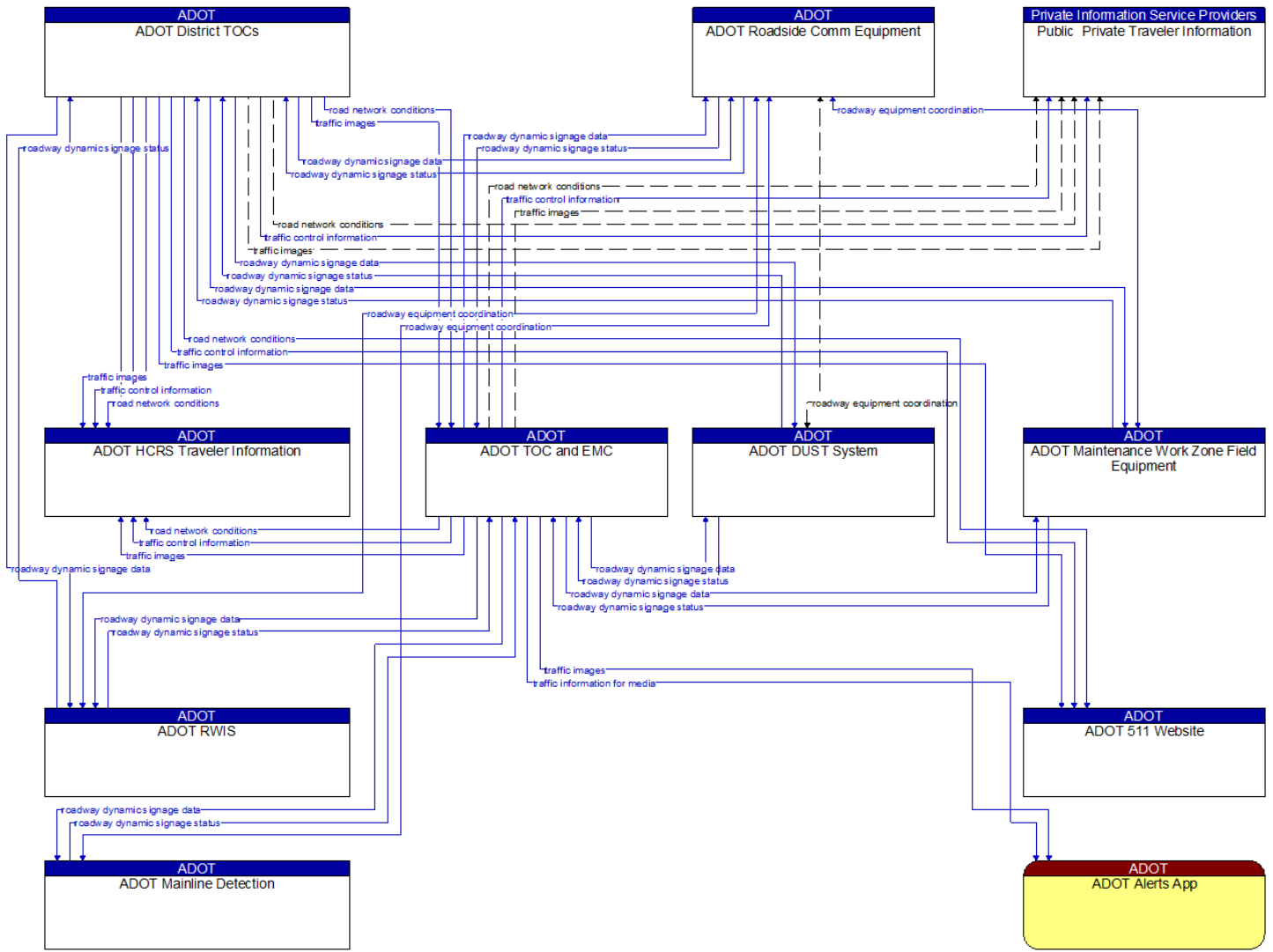

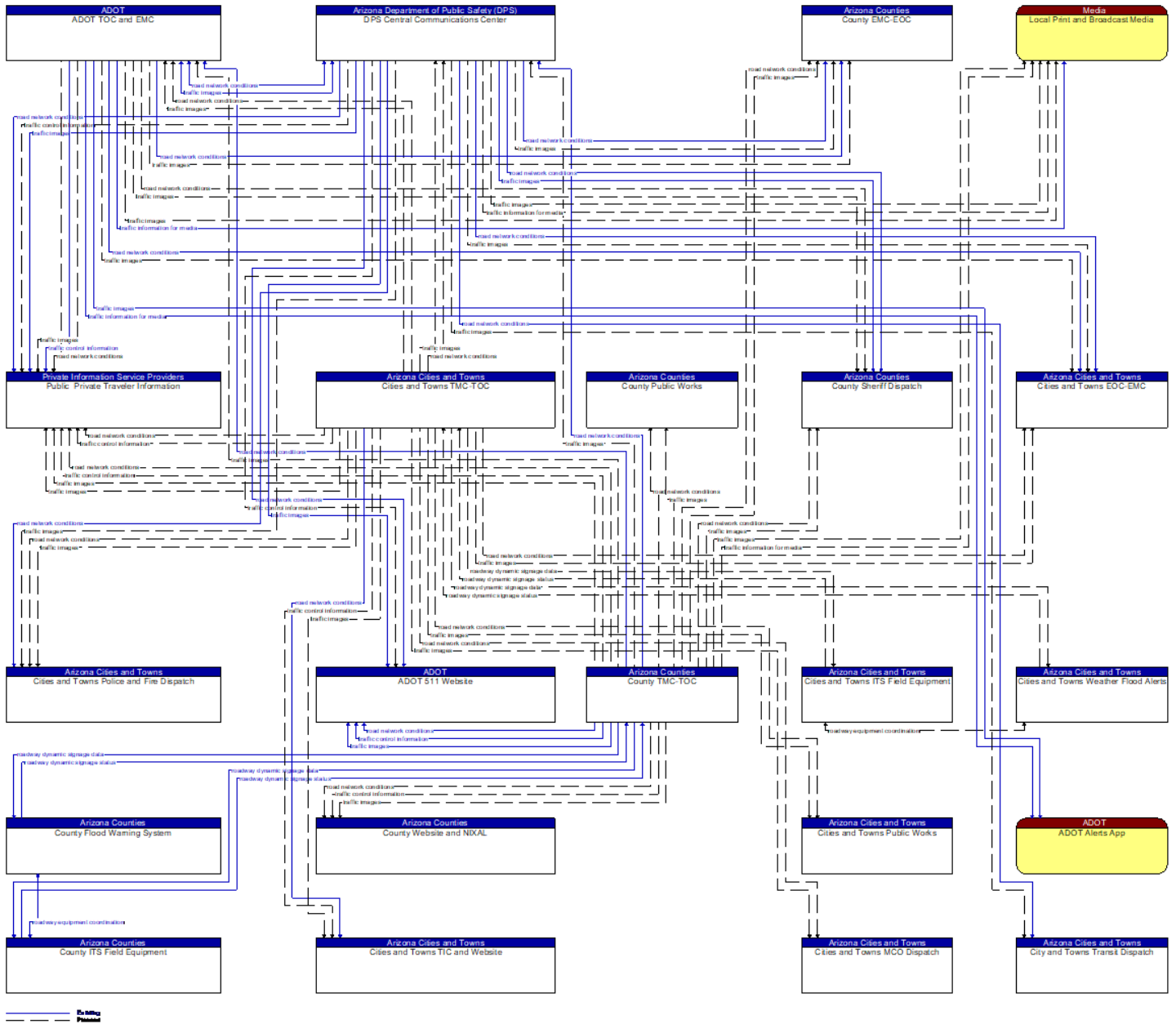

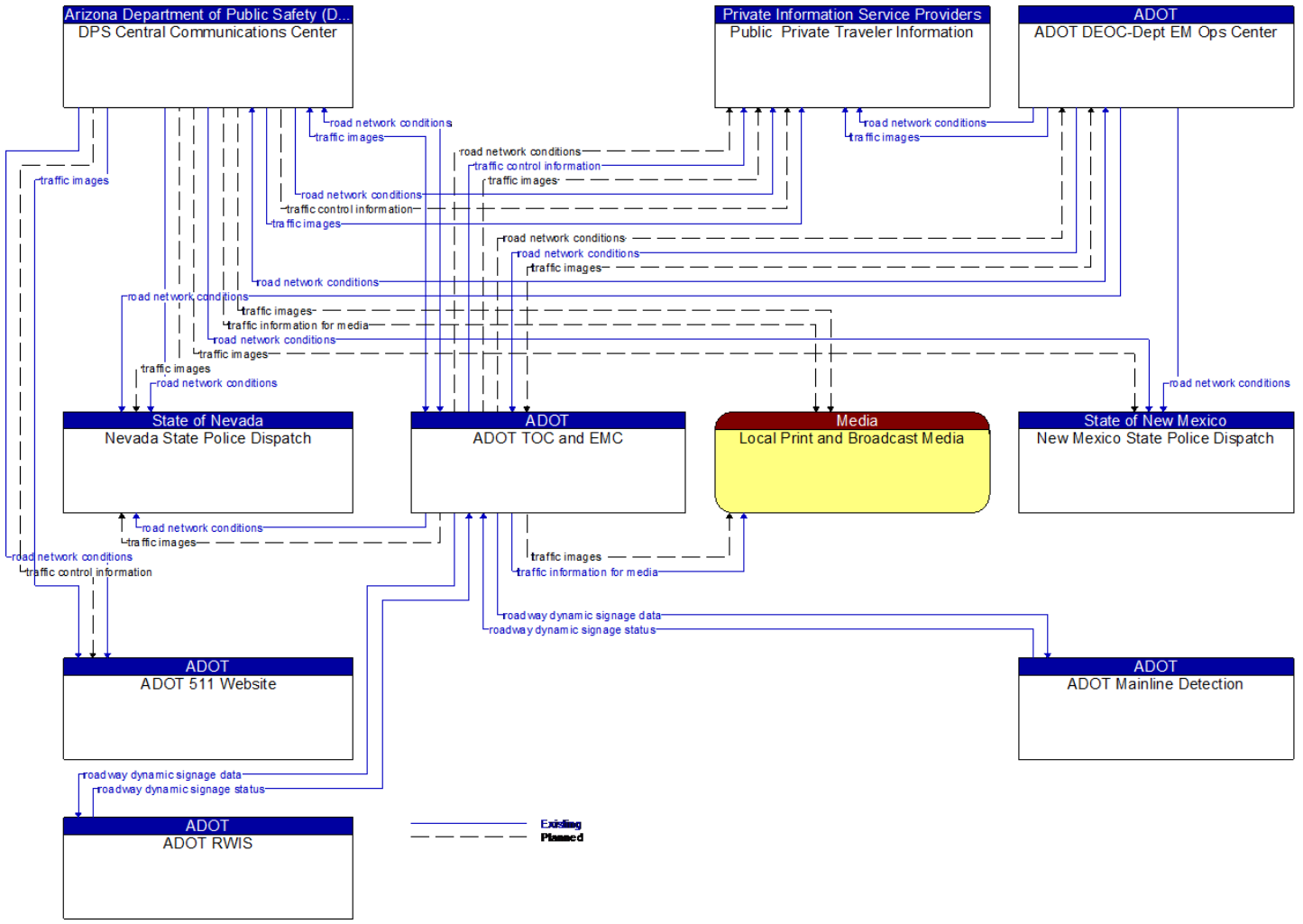

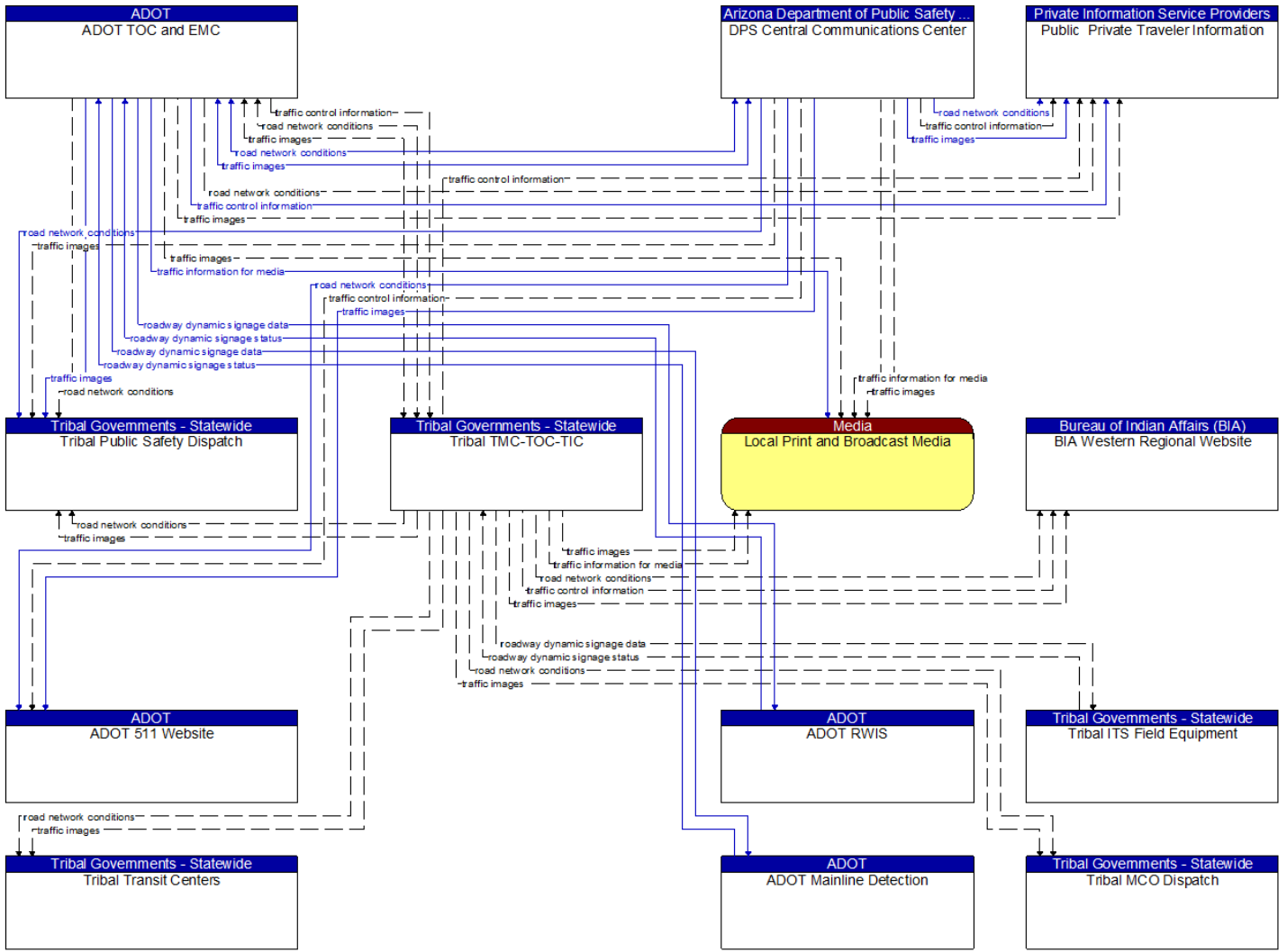

— Existing  
 - - - Planned



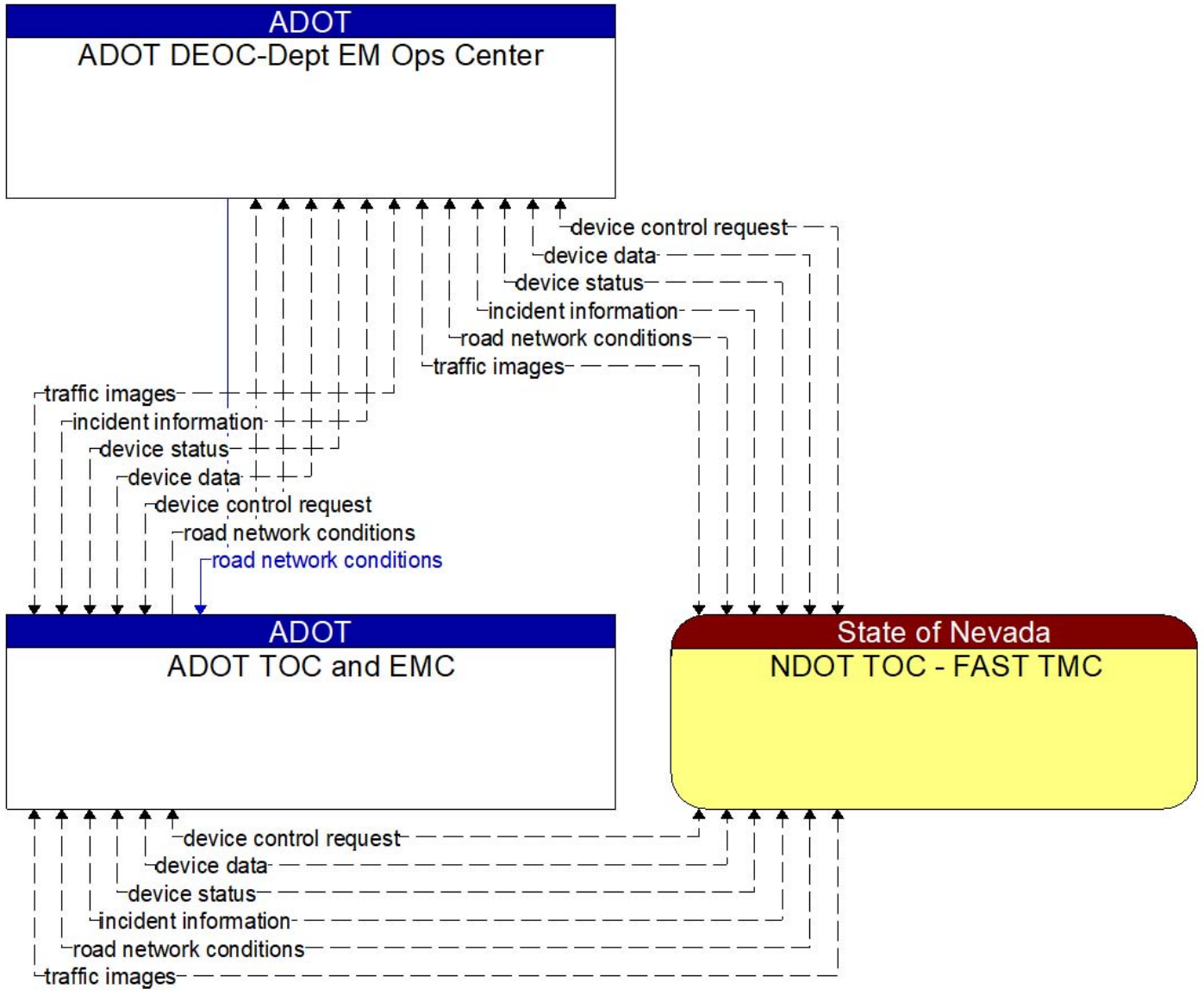

\_\_\_\_\_ Existing  
 - - - - - Planned

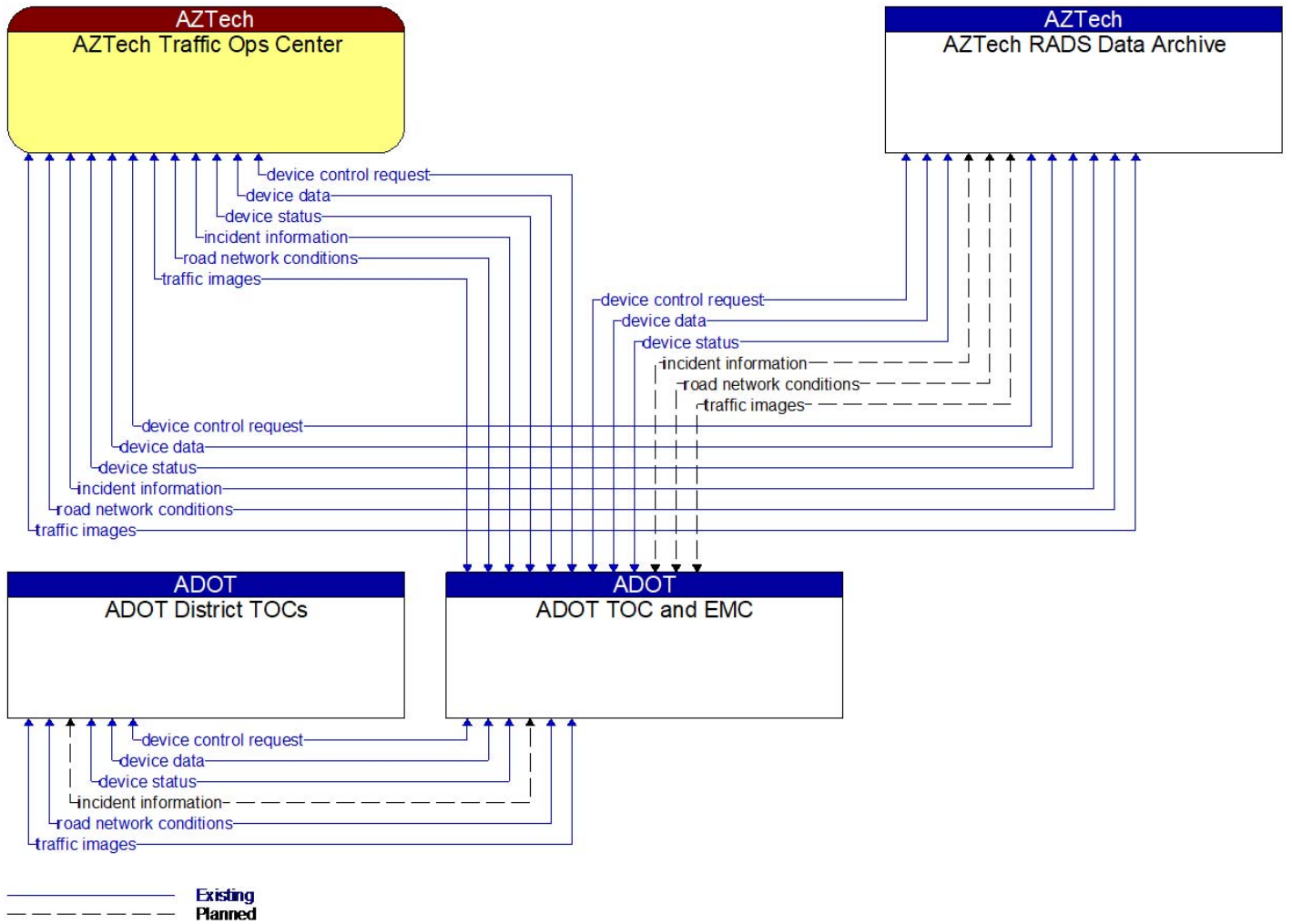

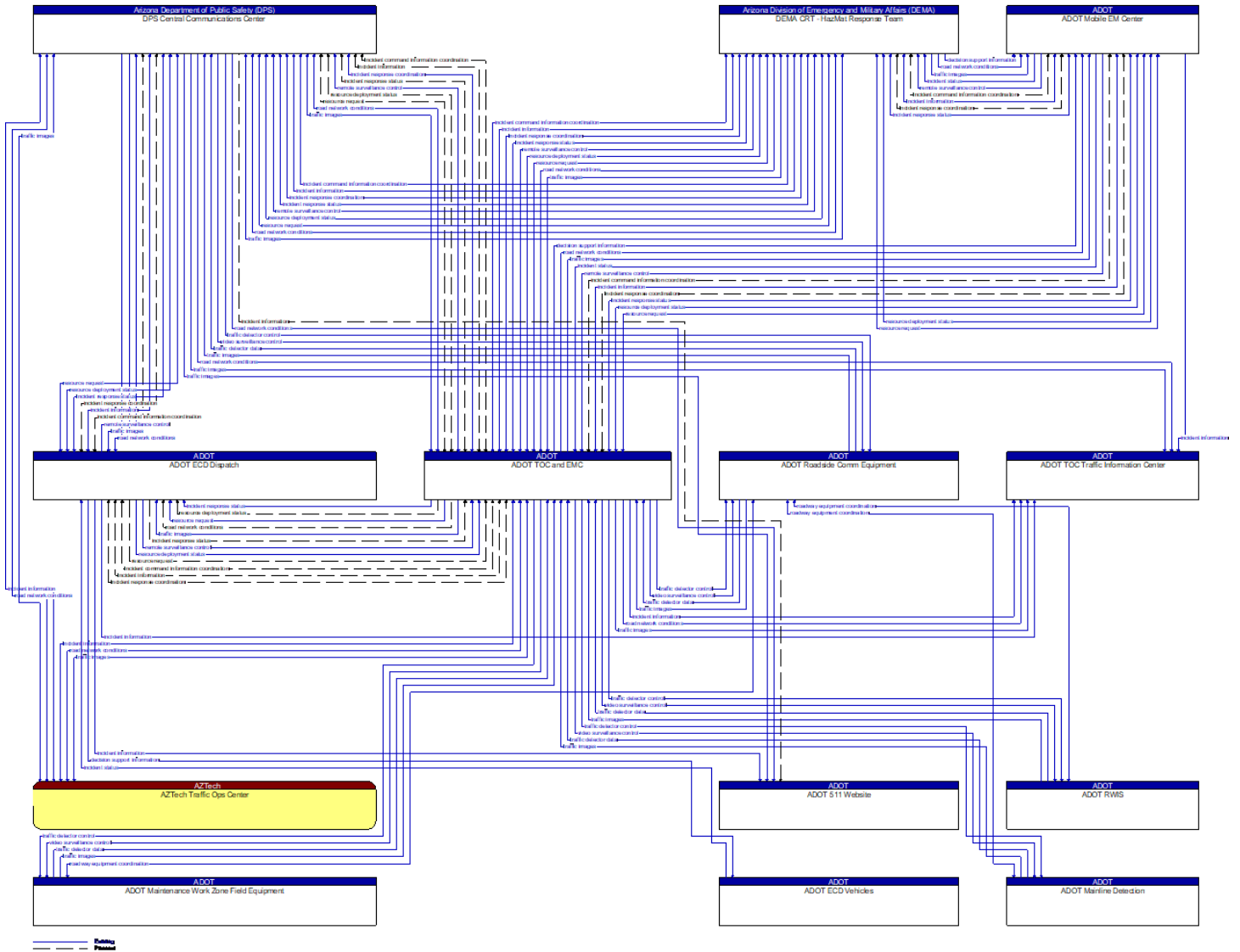





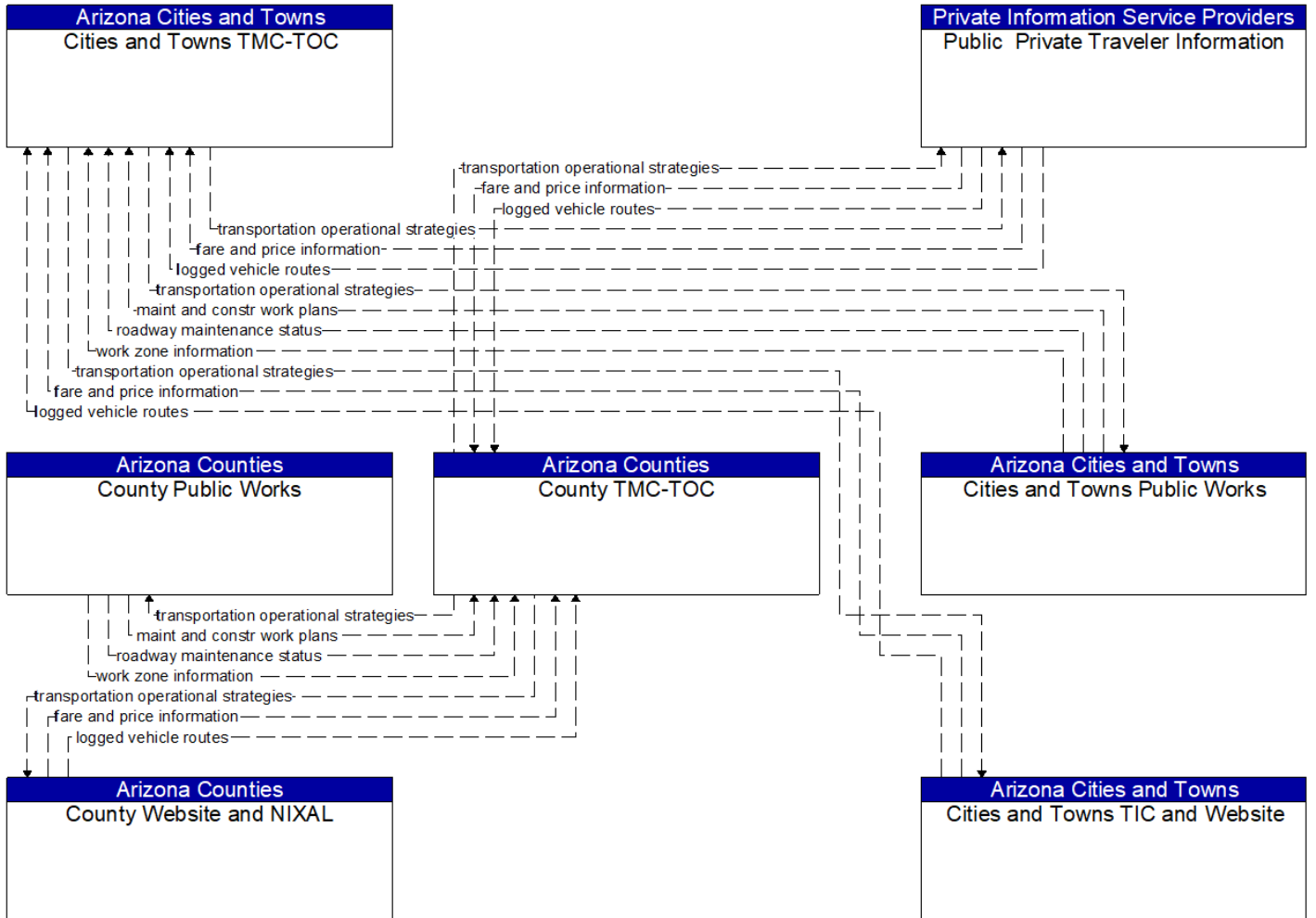

----- Planned

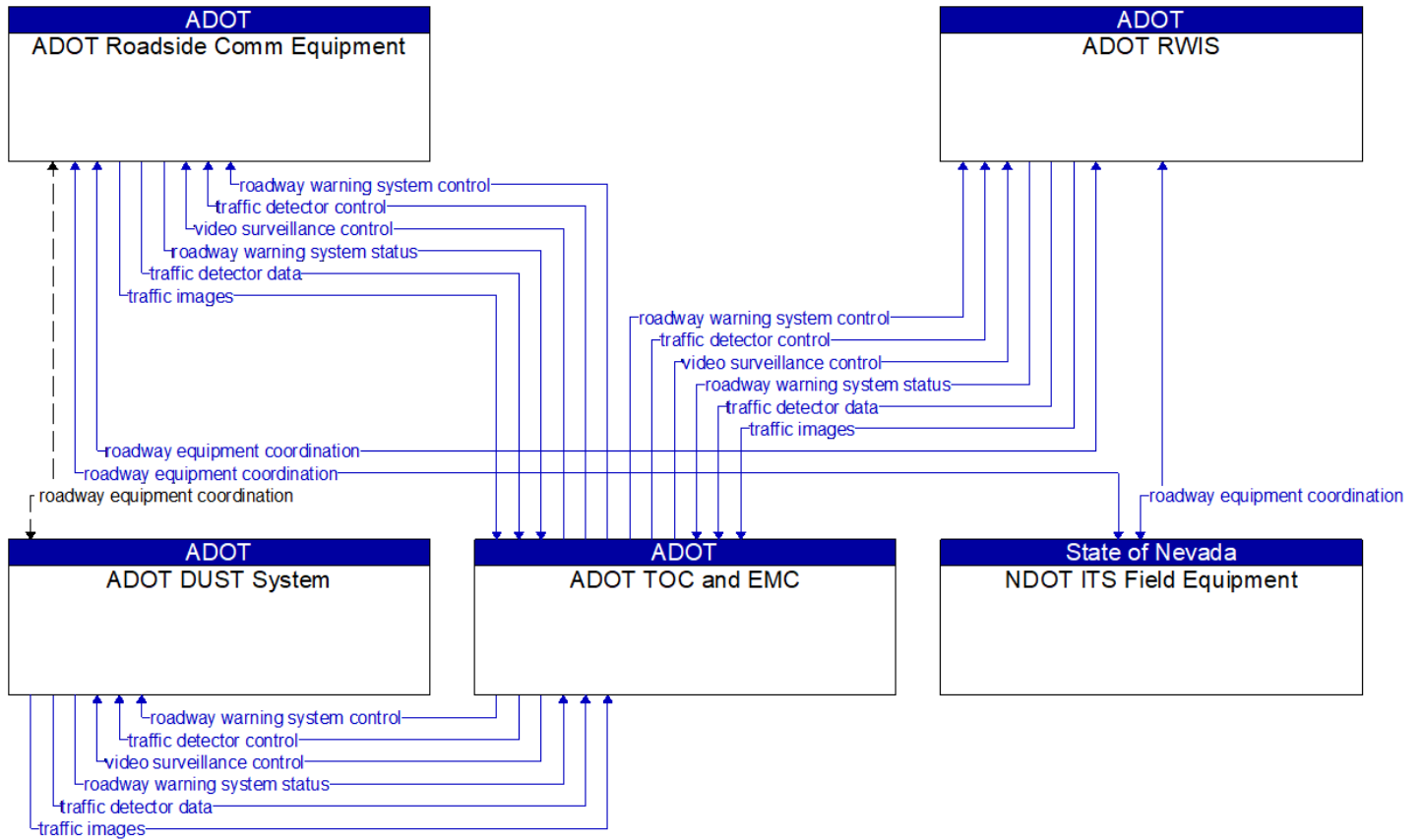

— Existing  
 - - - Planned

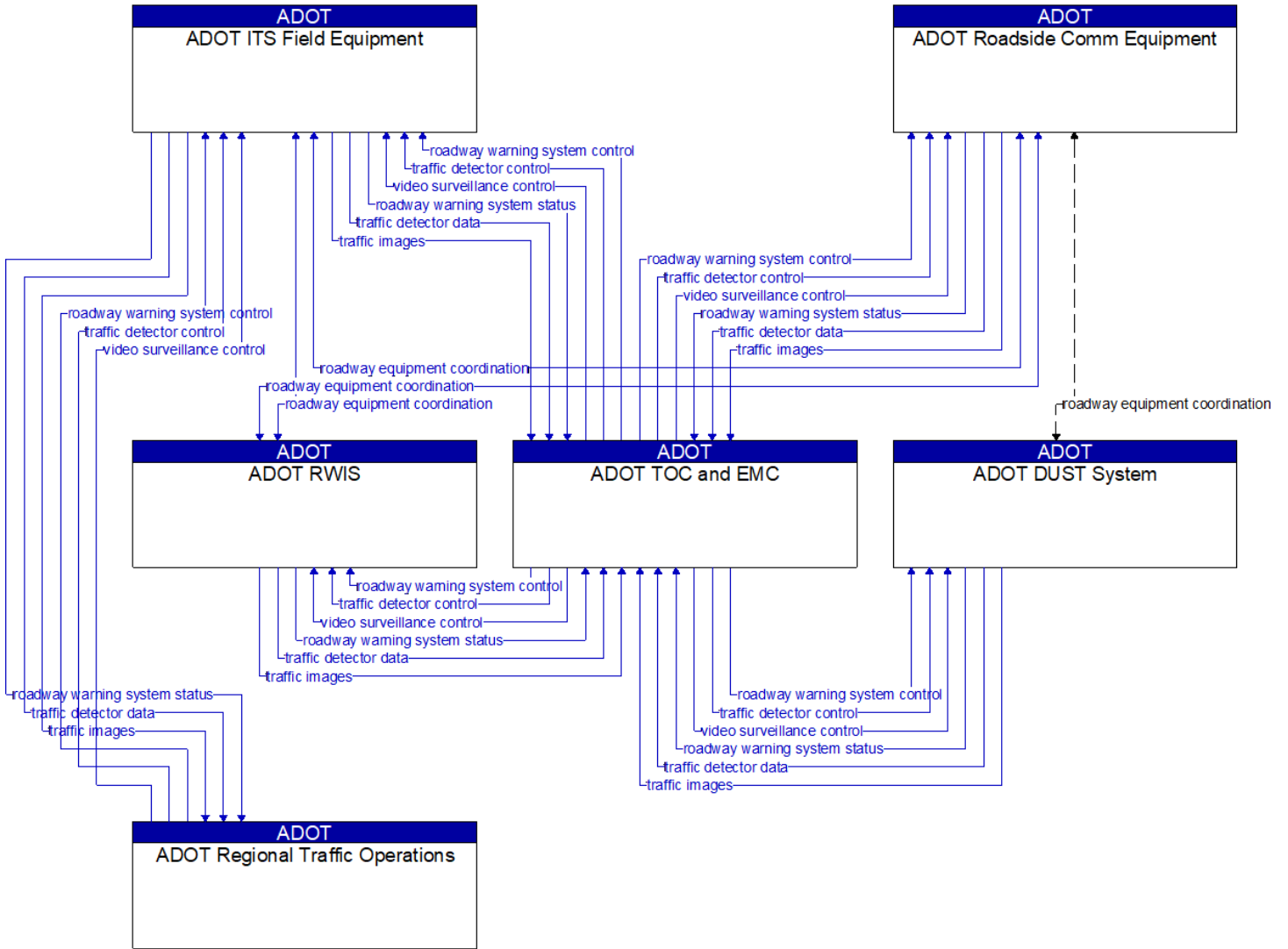

— Existing  
 - - - Planned



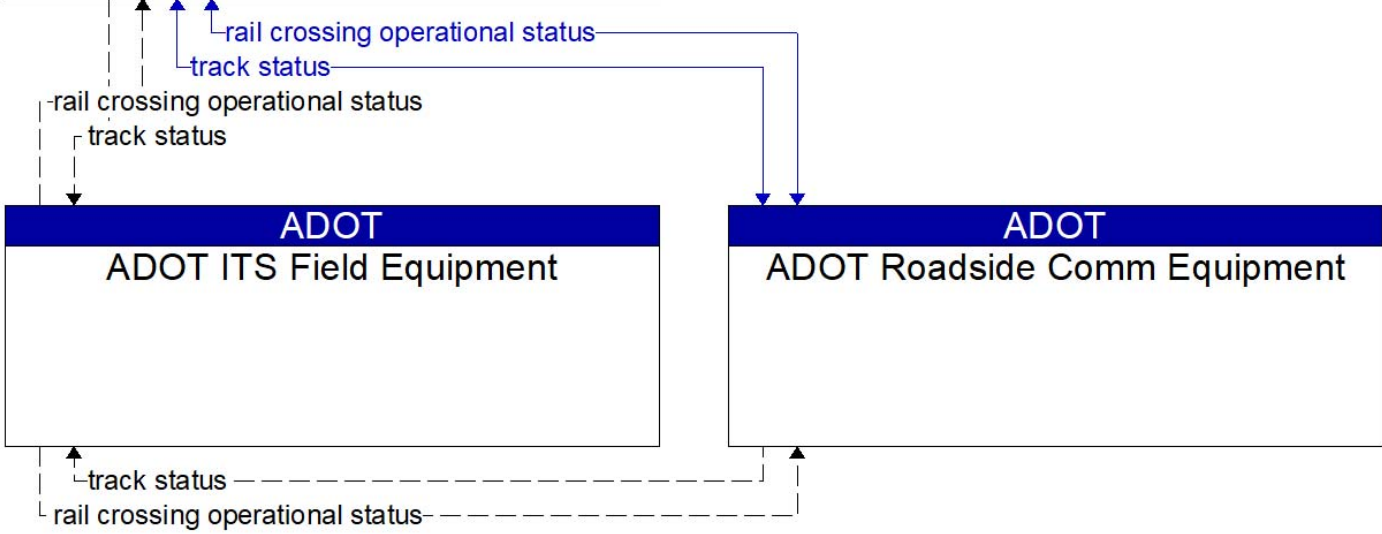
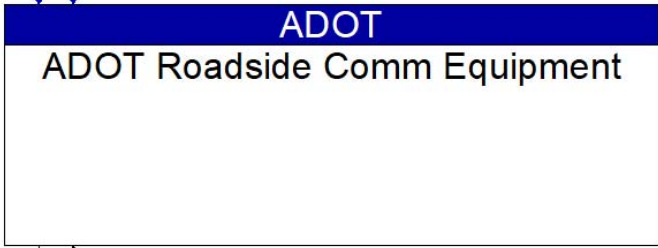
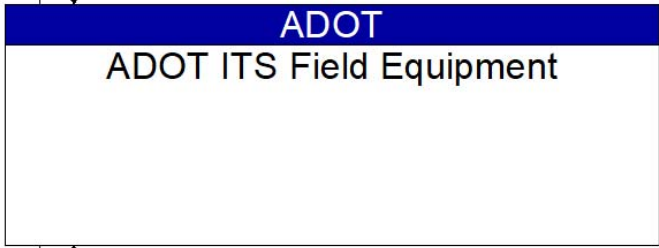
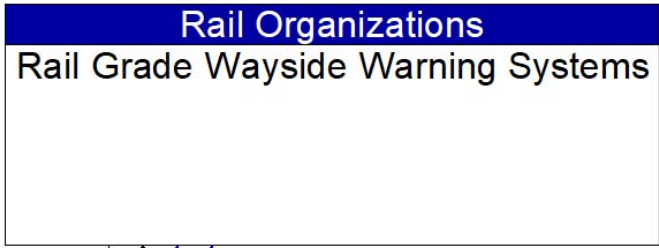

———— Existing  
----- Planned

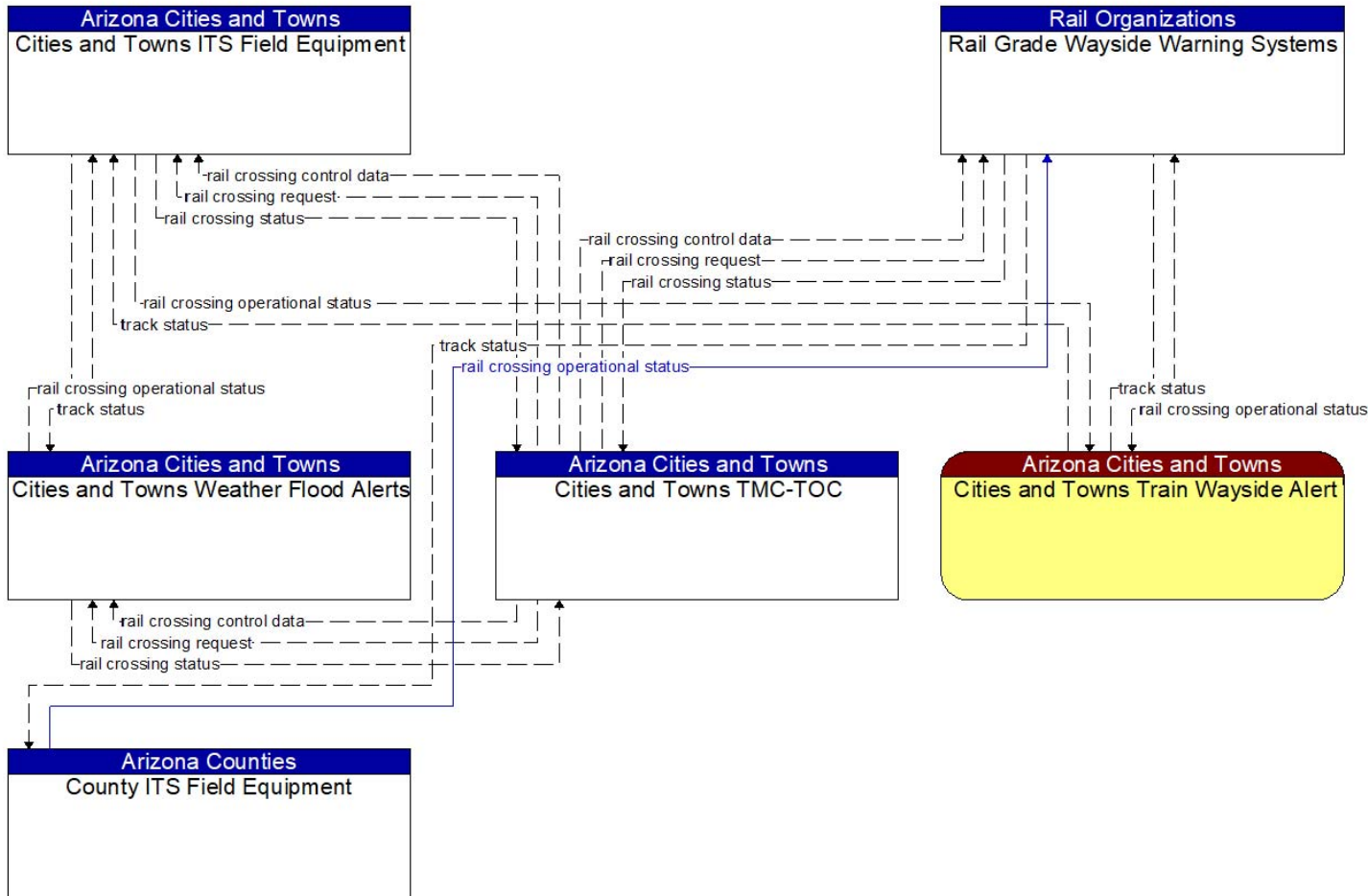

— Existing  
 - - - Planned

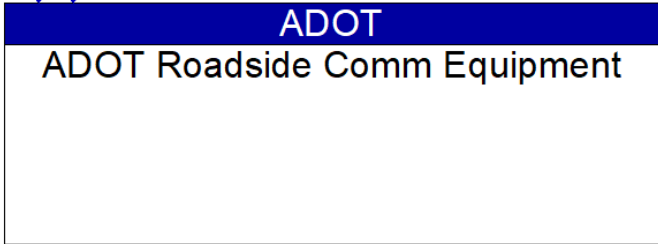
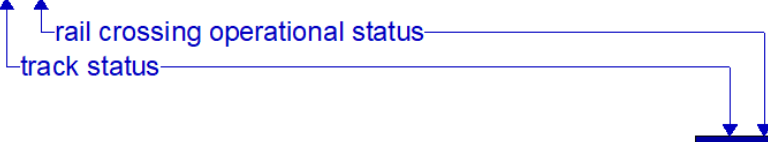
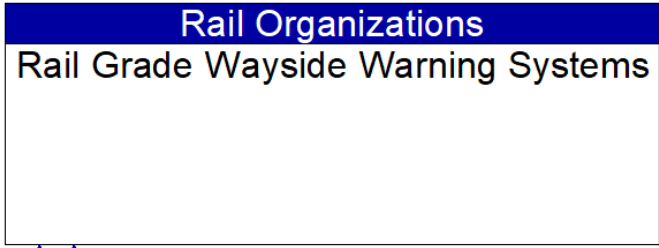

———— Existing

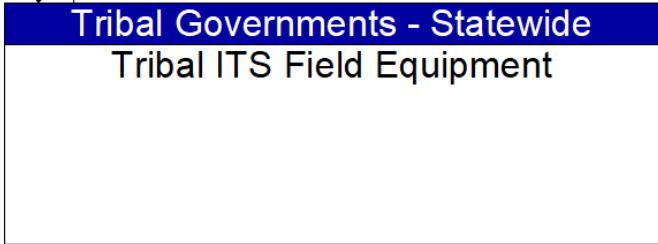
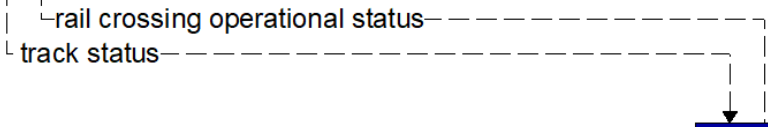
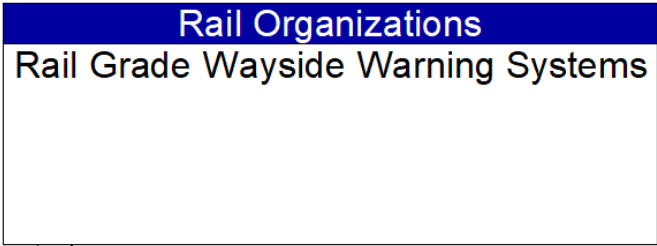

----- **Planned**

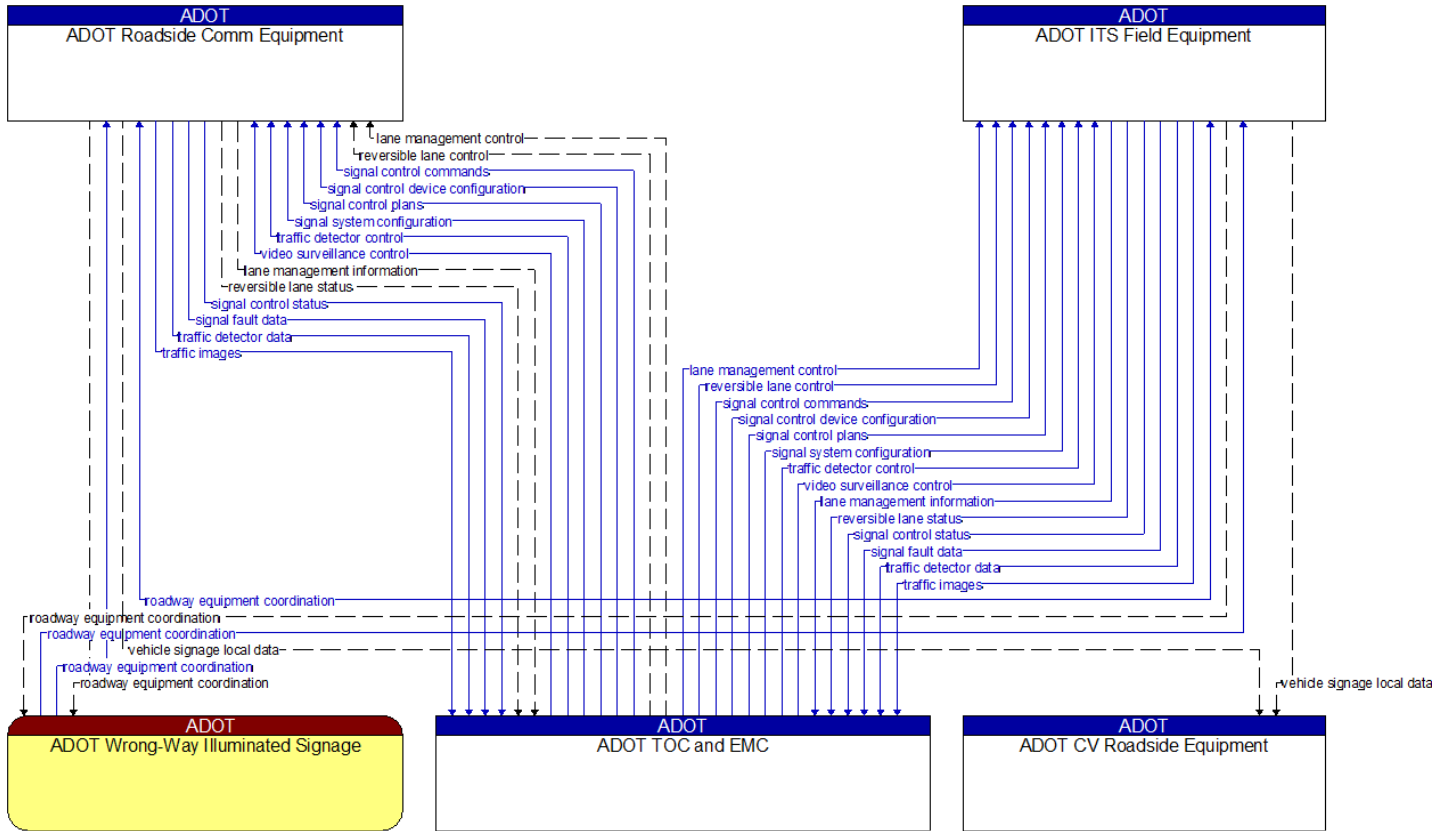

——— Existing  
- - - - Planned

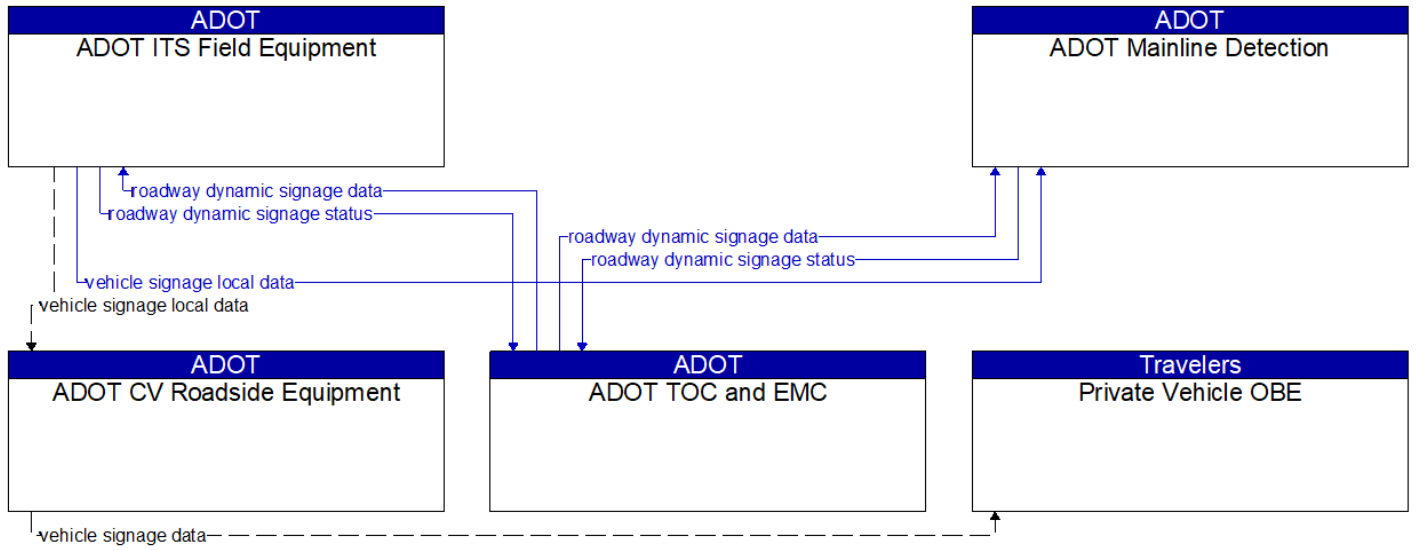

— Existing  
 - - - Planned

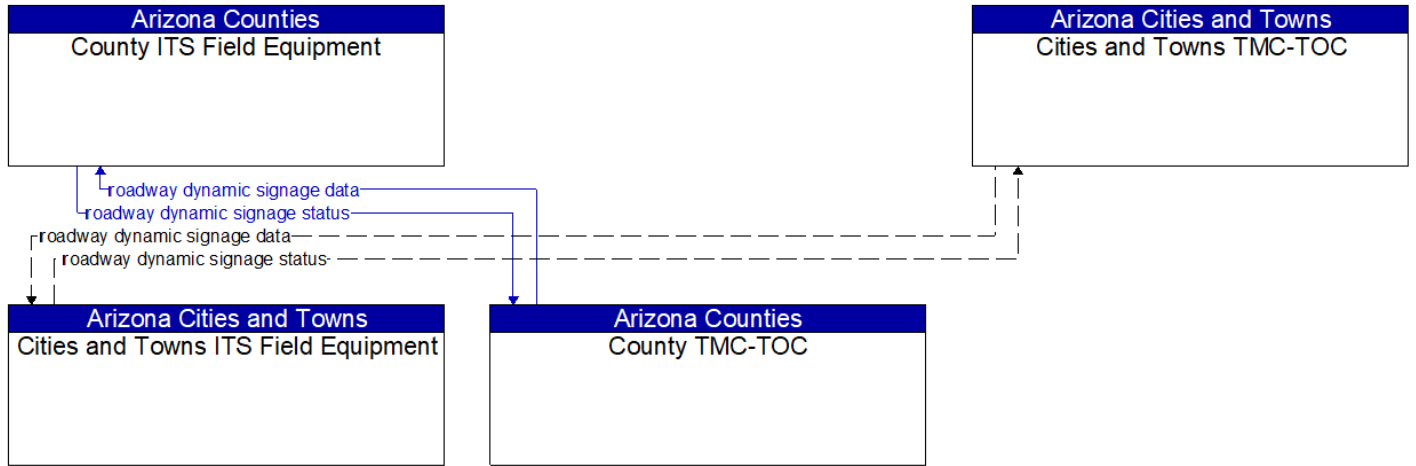

— Existing  
 - - - Planned

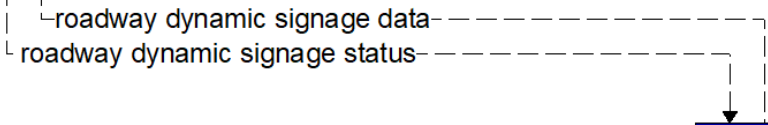
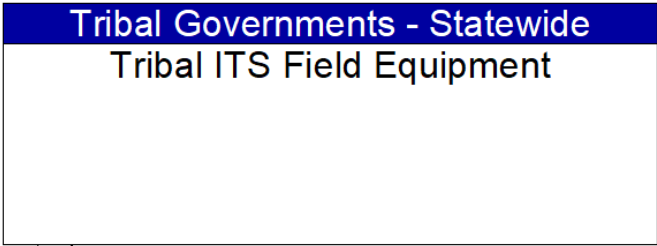

----- **Planned**



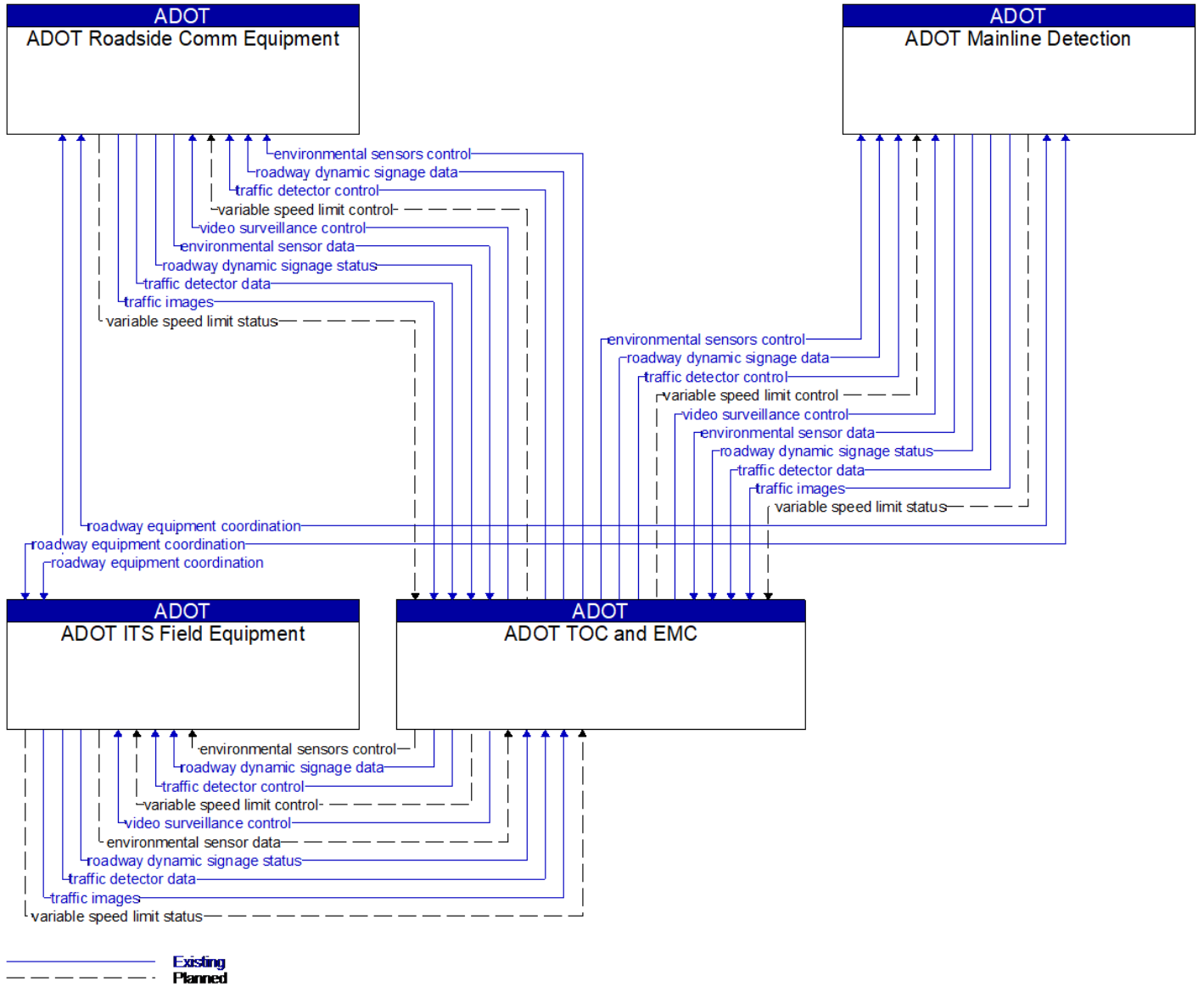

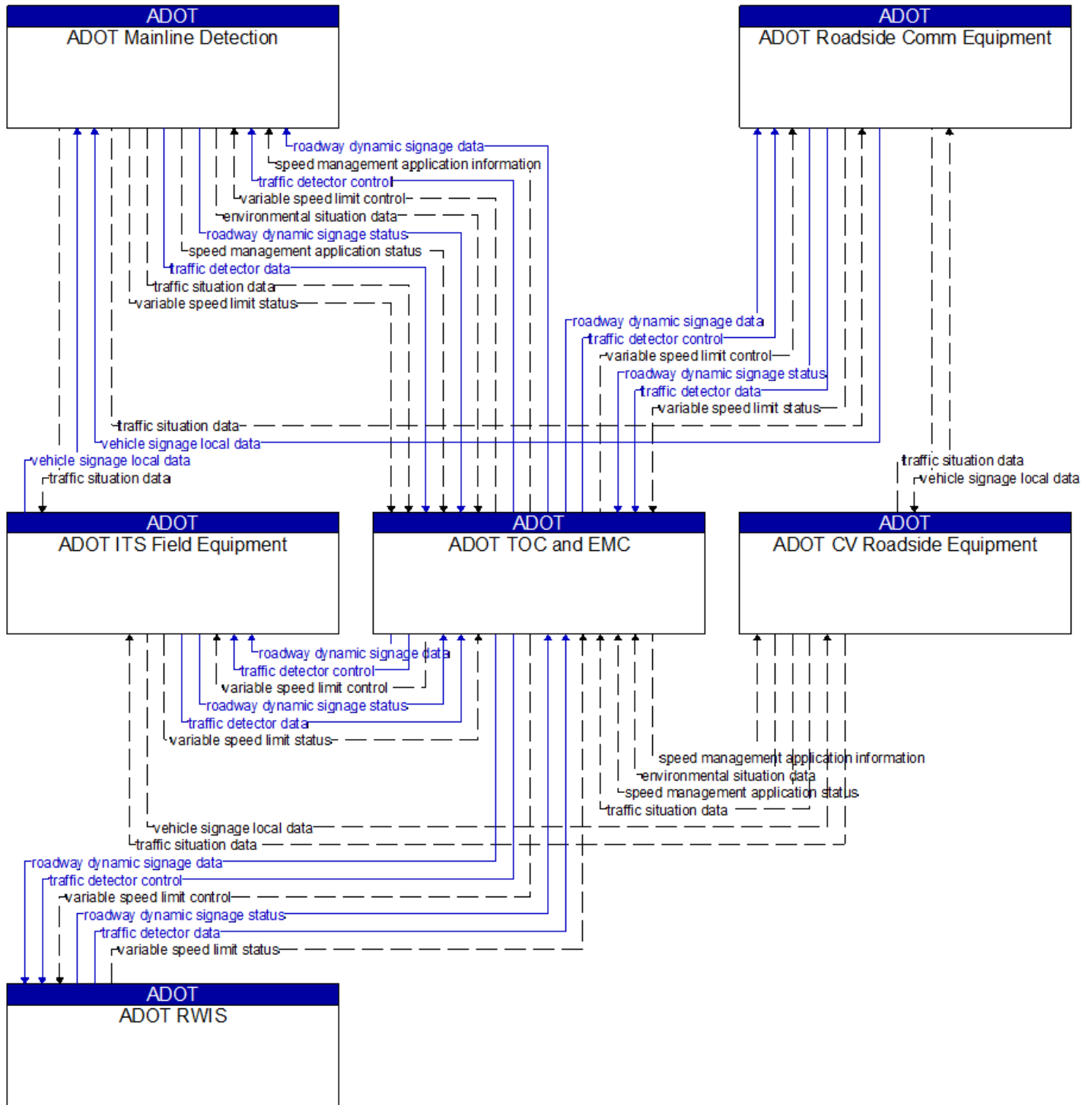

——— Existing  
 - - - - - Planned

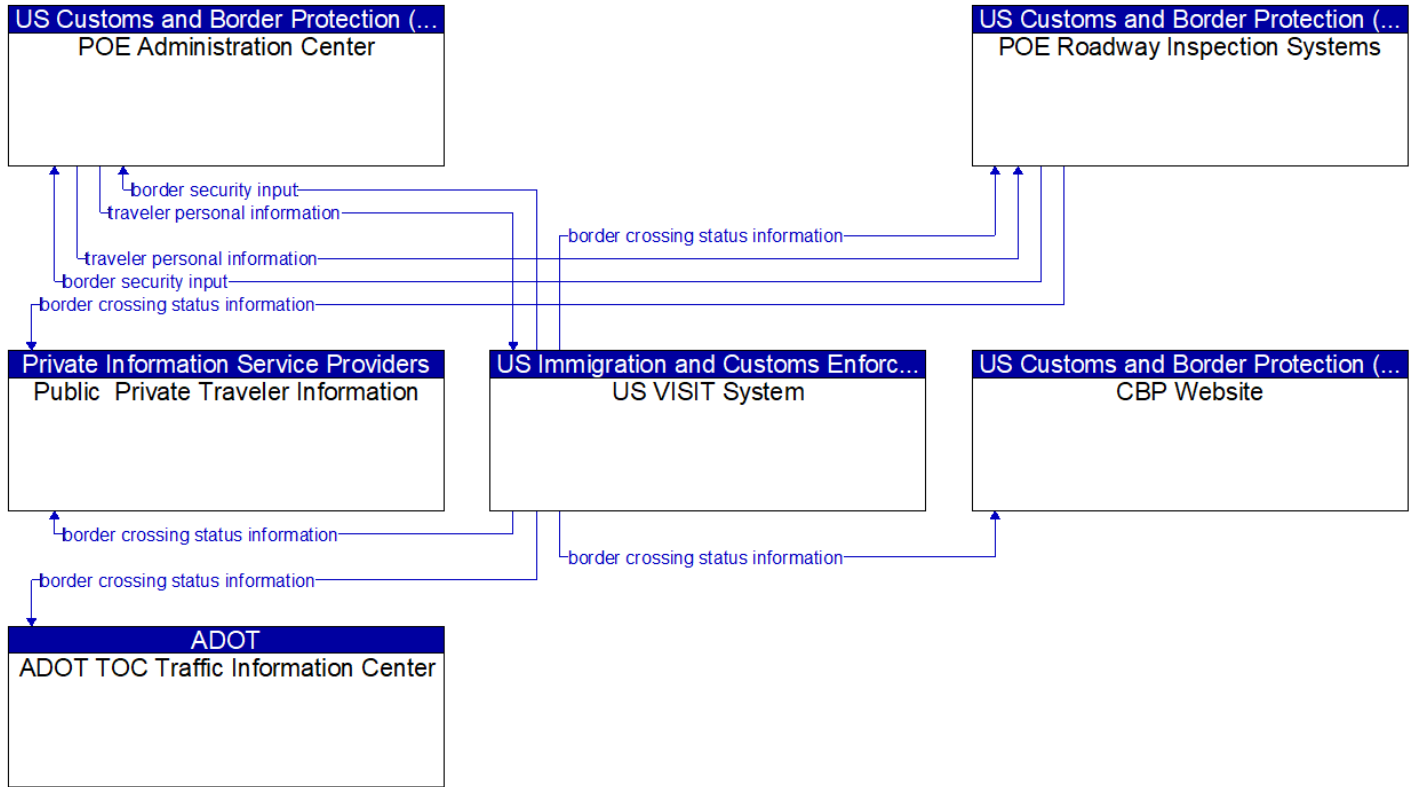

Existing

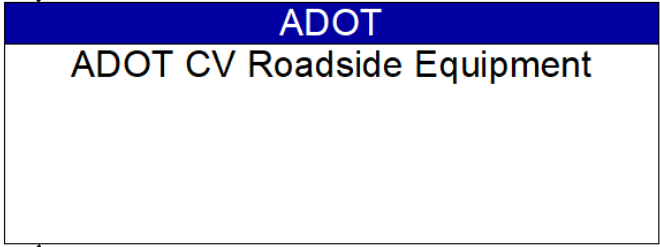
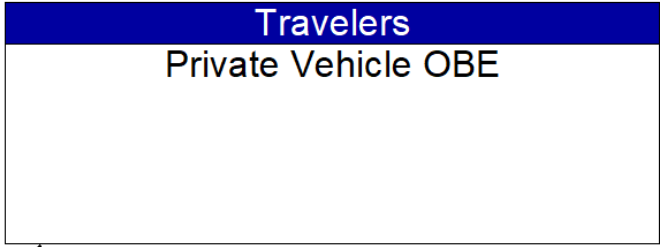
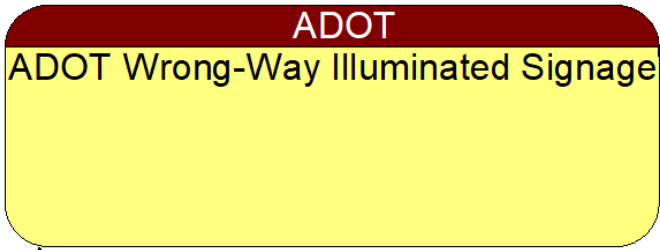

wrong way vehicle detected

wrong way vehicle detected

----- Planned



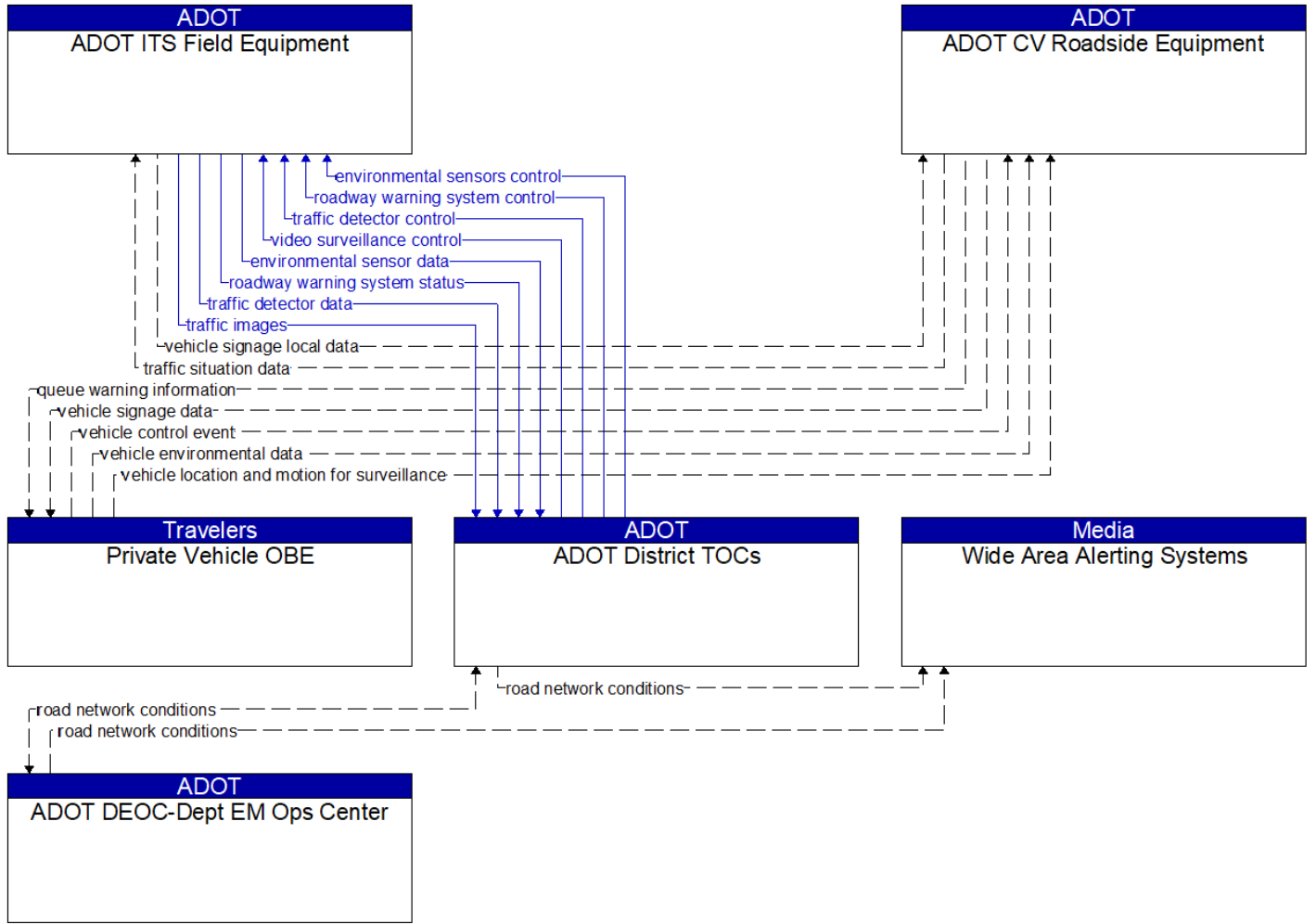

——— Existing  
 - - - - - Planned

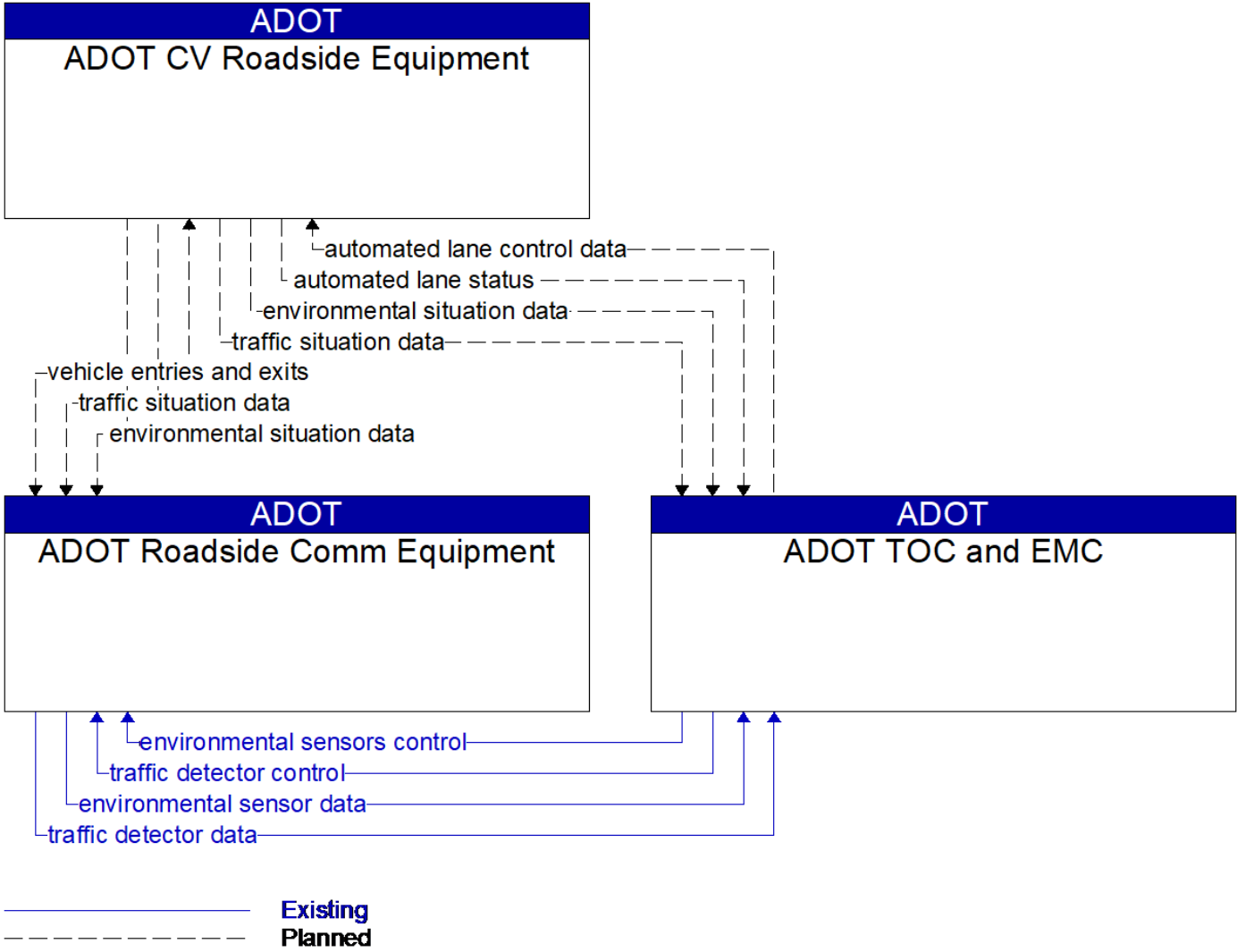

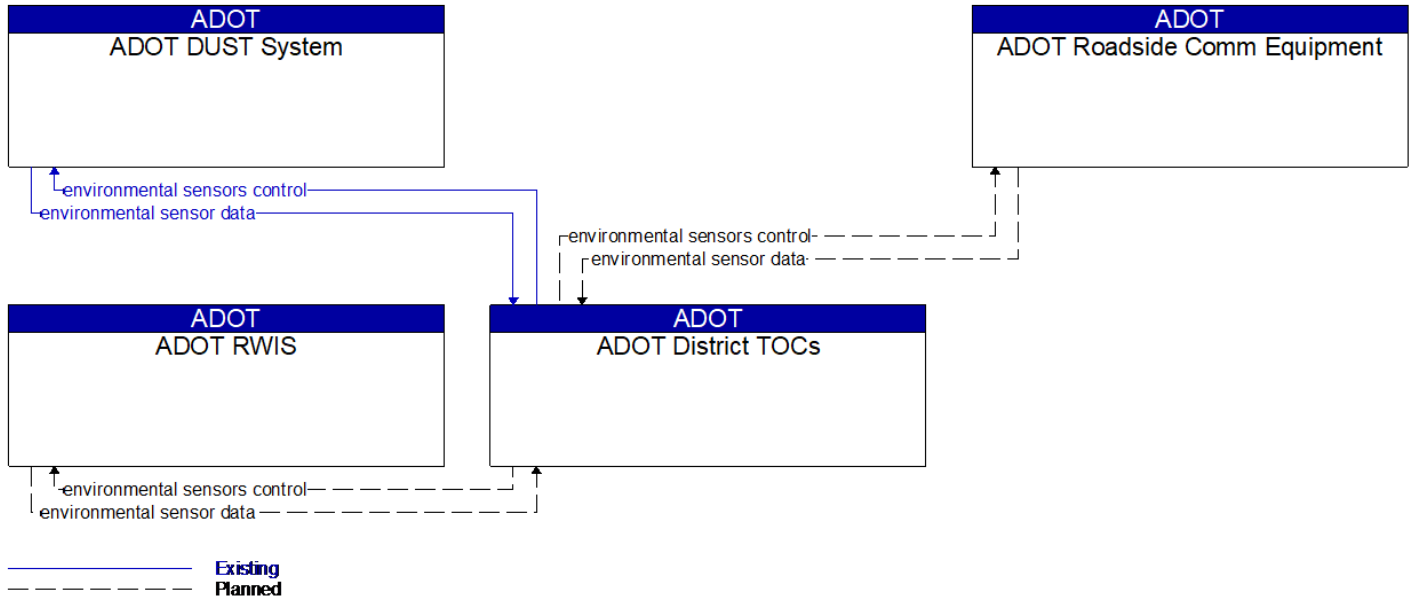



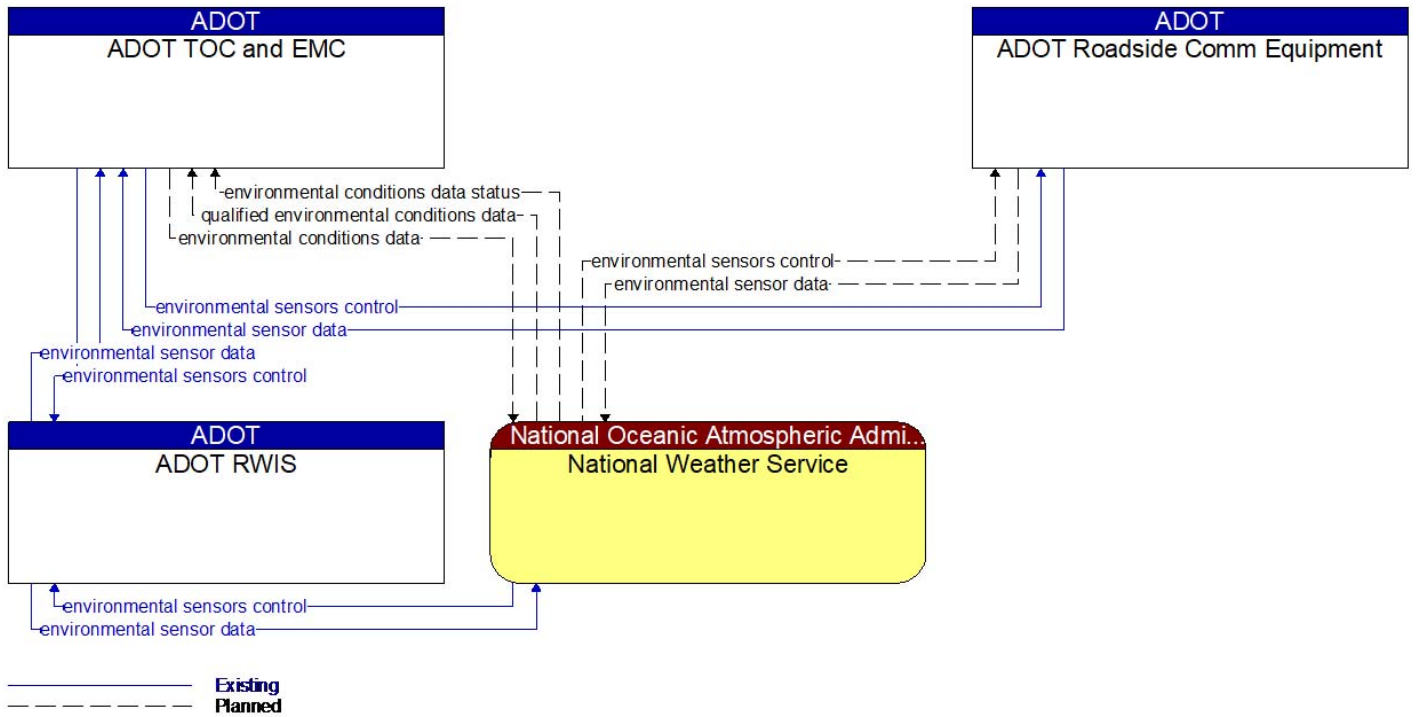

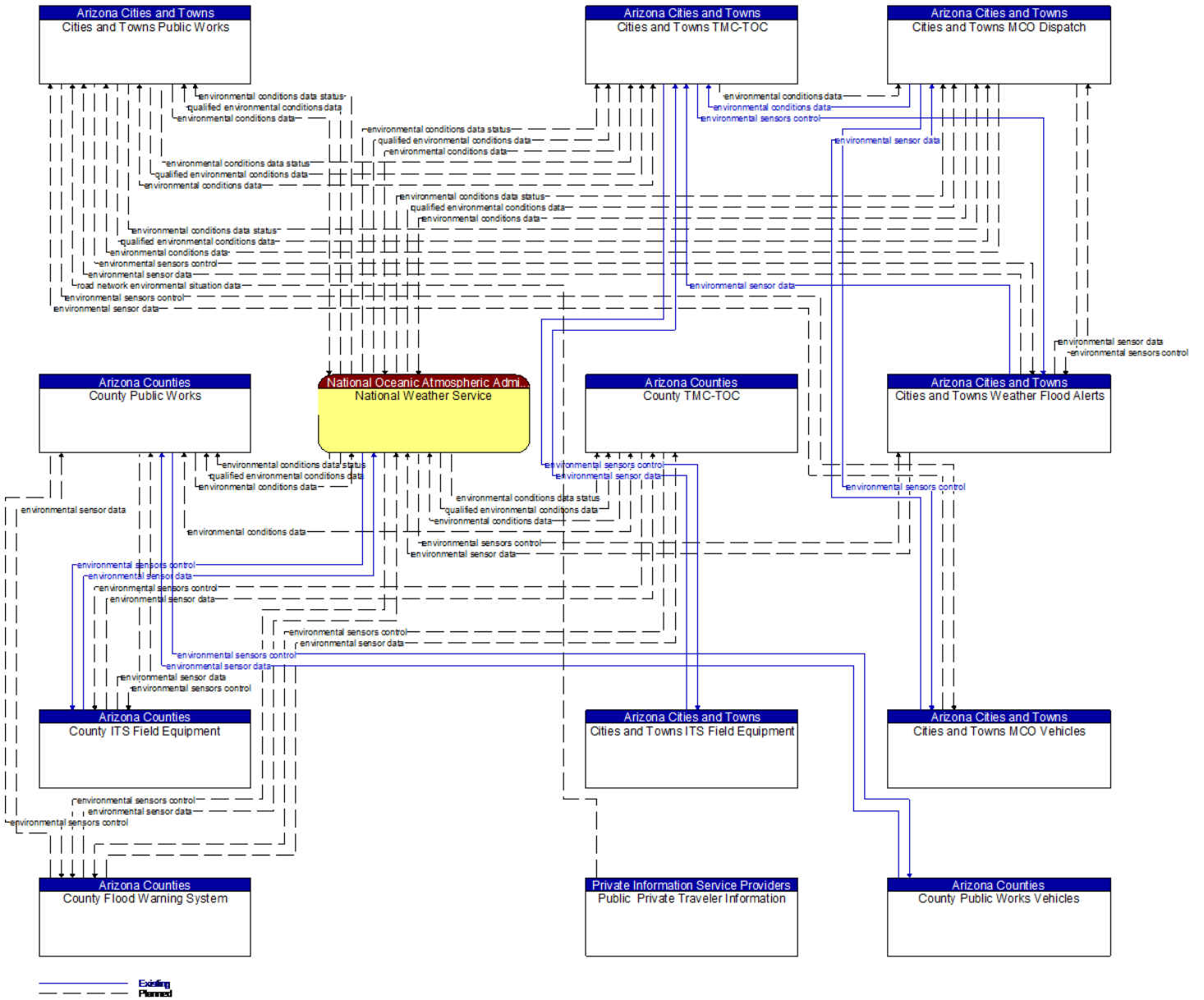

Arizona Cities and Towns  
Cities and Towns Public Works

Arizona Cities and Towns  
Cities and Towns TMC-TOC

Arizona Cities and Towns  
Cities and Towns MCO Dispatch

Arizona Counties  
County Public Works

National Oceanic Atmospheric Adm.  
National Weather Service

Arizona Counties  
County TMC-TOC

Arizona Cities and Towns  
Cities and Towns Weather Flood Alerts

Arizona Counties  
County ITS Field Equipment

Arizona Cities and Towns  
Cities and Towns ITS Field Equipment

Arizona Cities and Towns  
Cities and Towns MCO Vehicles

Arizona Counties  
County Flood Warning System

Private Information Service Providers  
Public Private Traveler Information

Arizona Counties  
County Public Works Vehicles

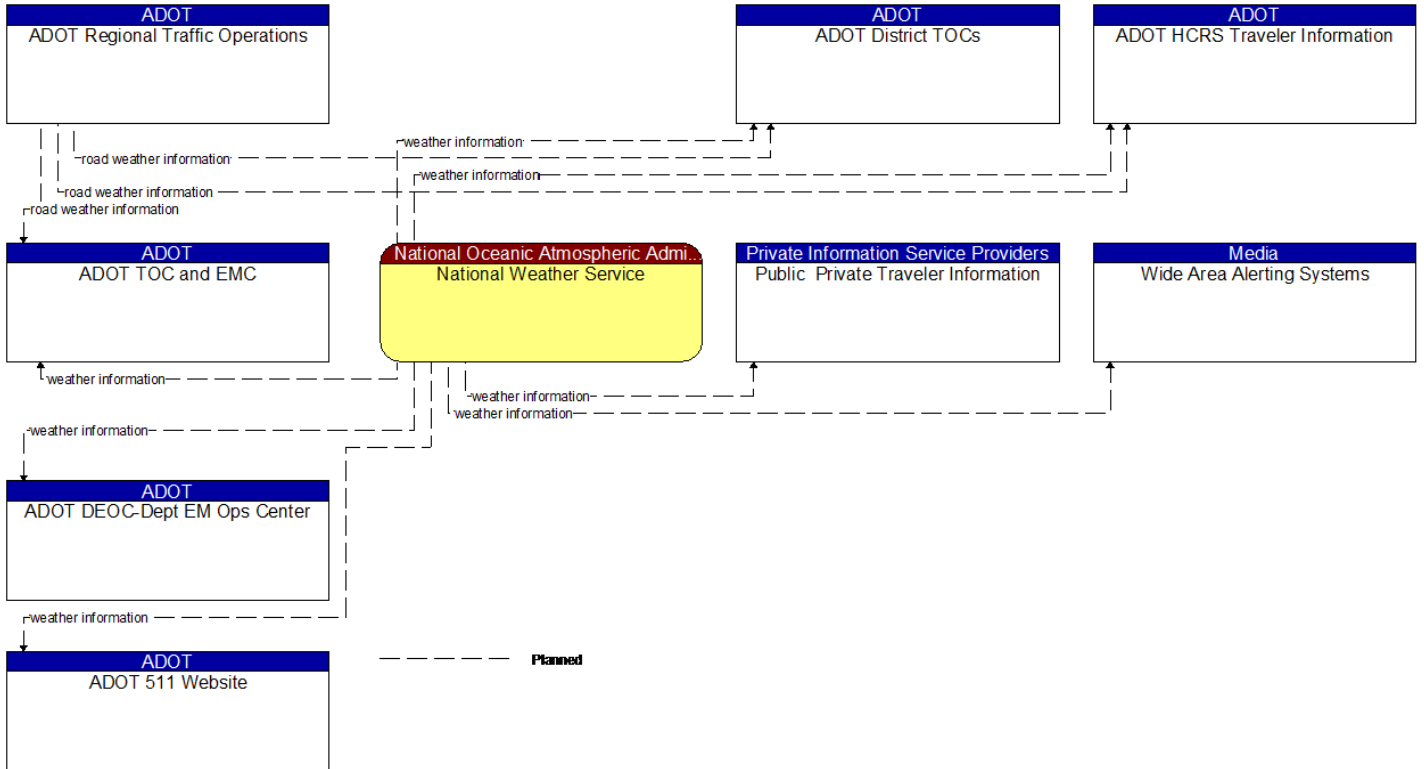

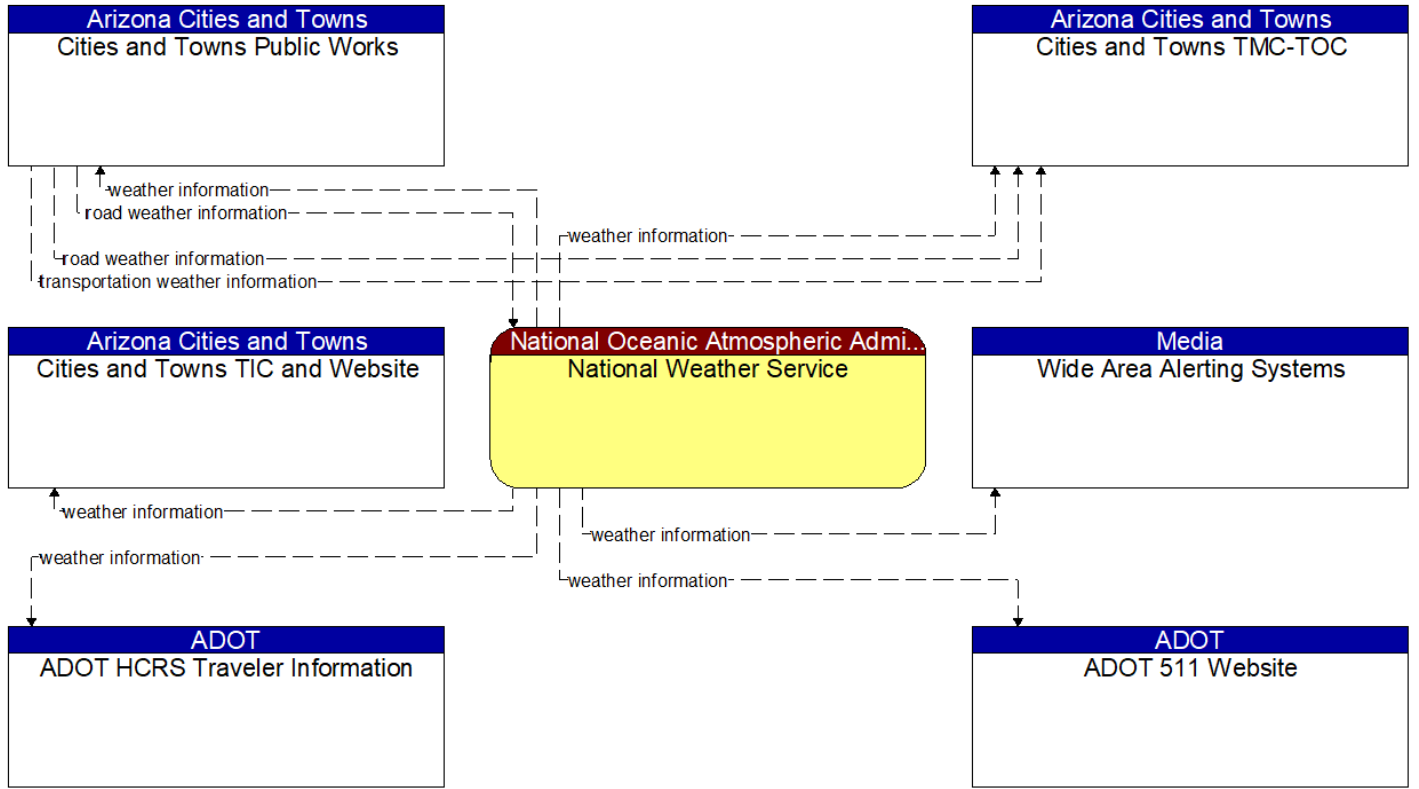

----- **Planned**

