

APPENDIX J

Flow Context Diagrams

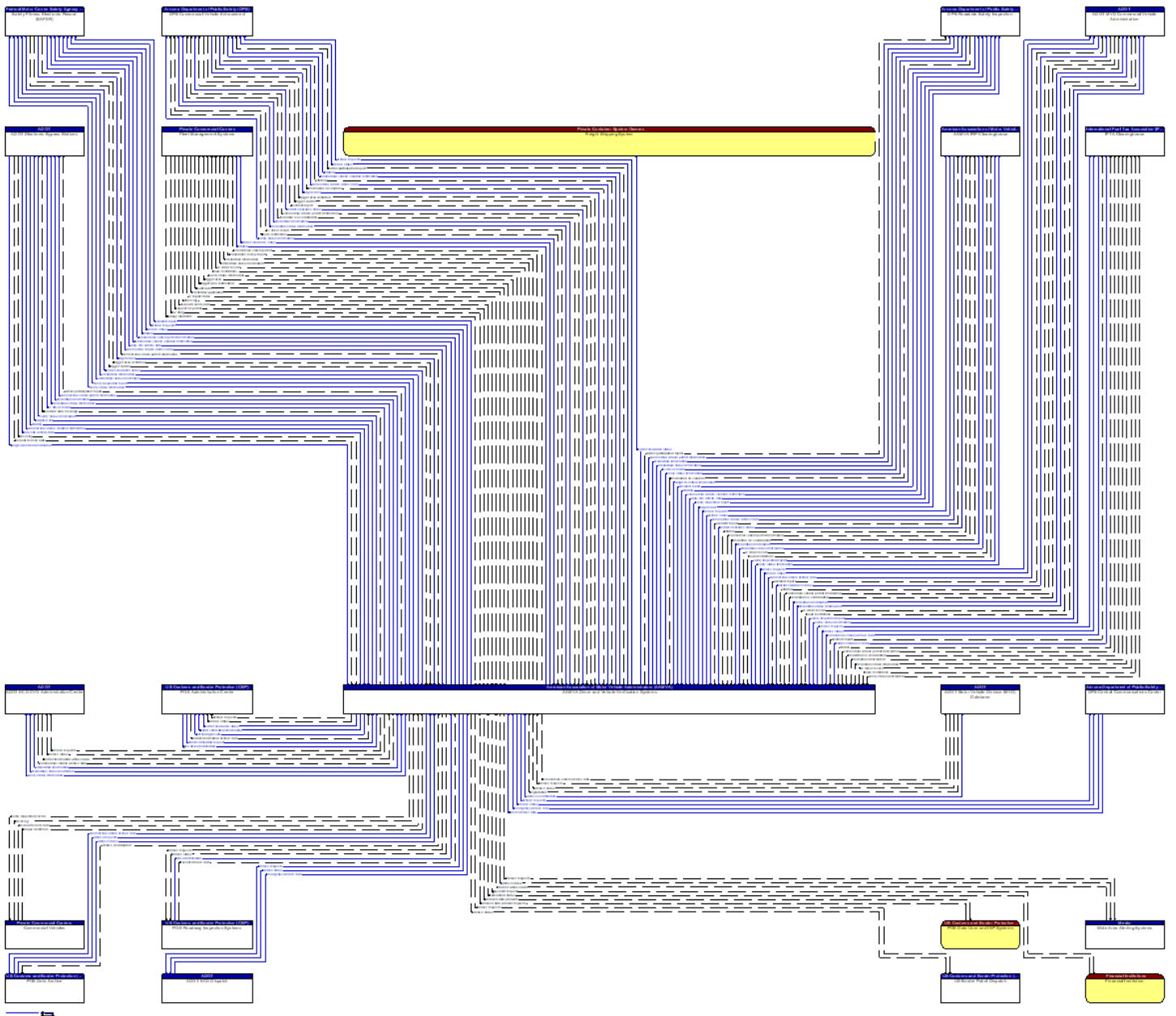

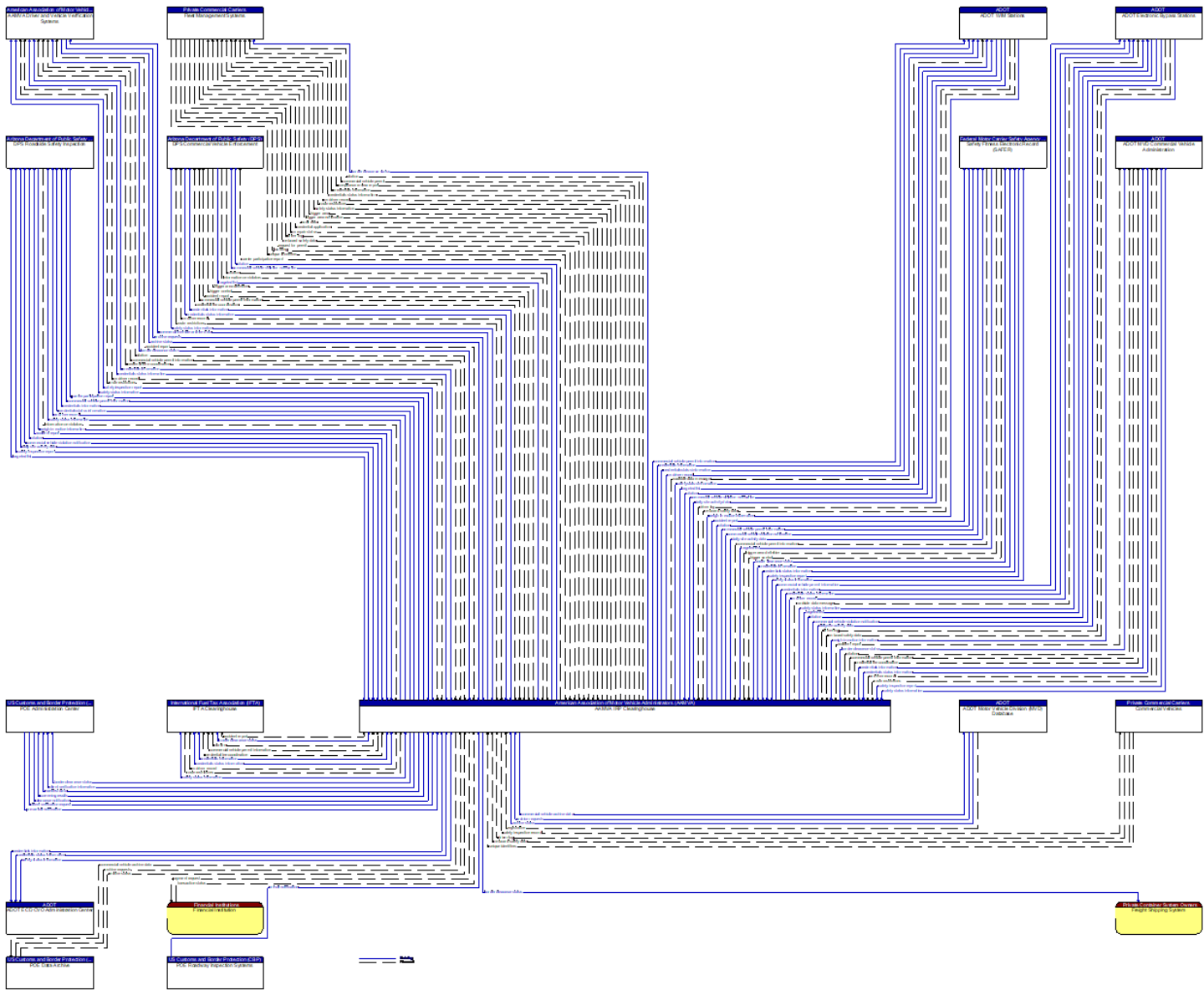

Legend:
— Blue line
— Red line

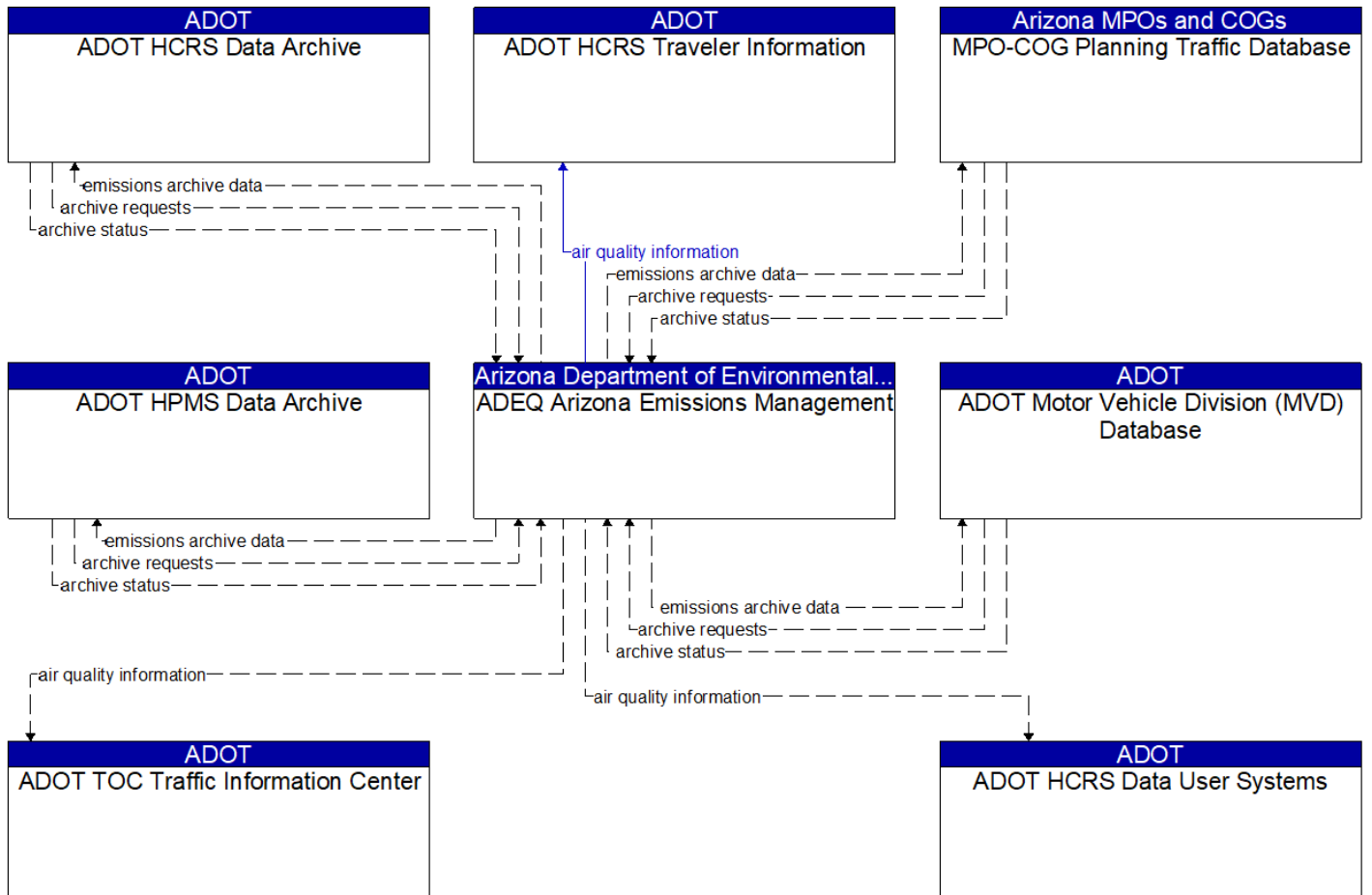

————— Existing
 - - - - - Planned

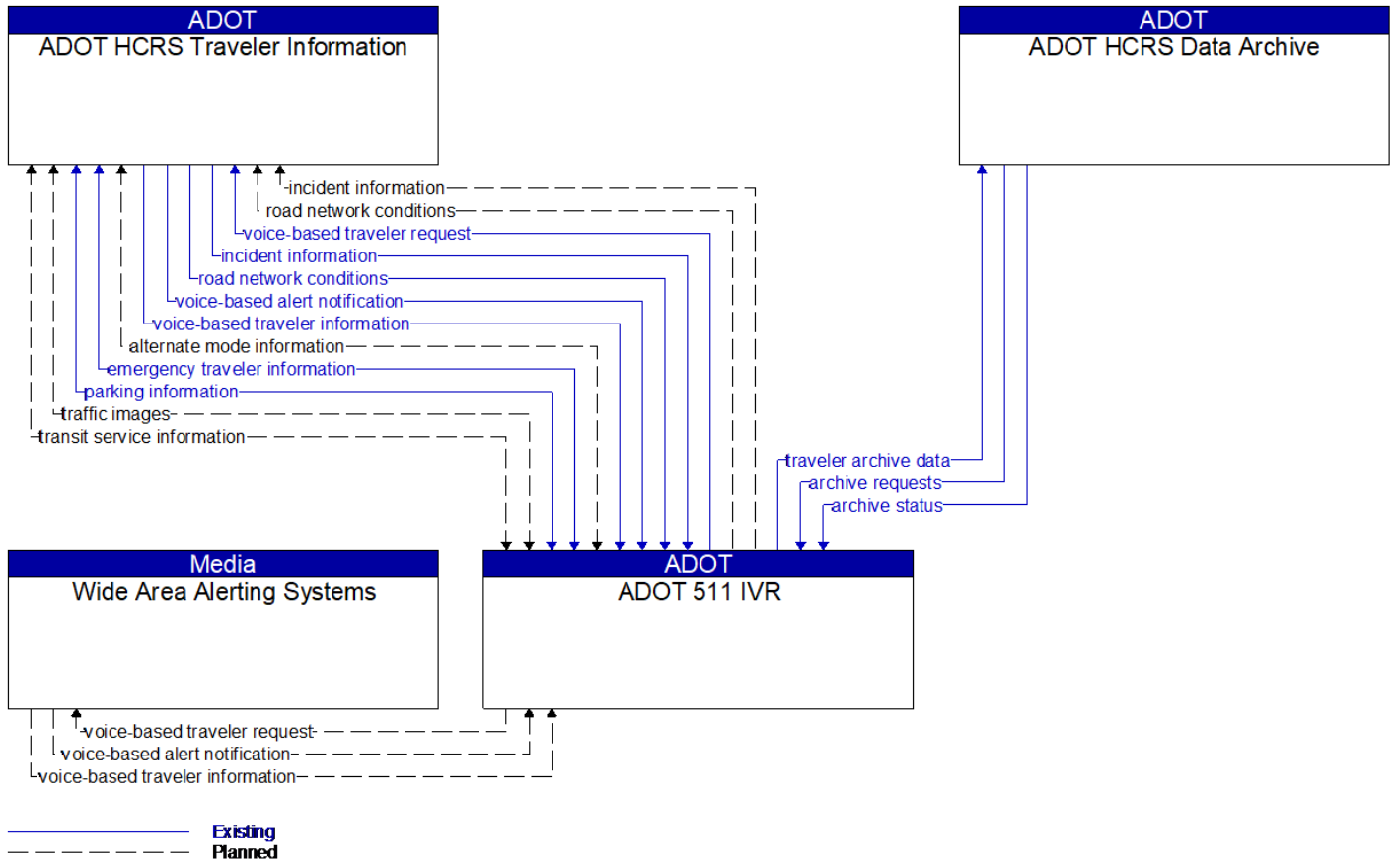

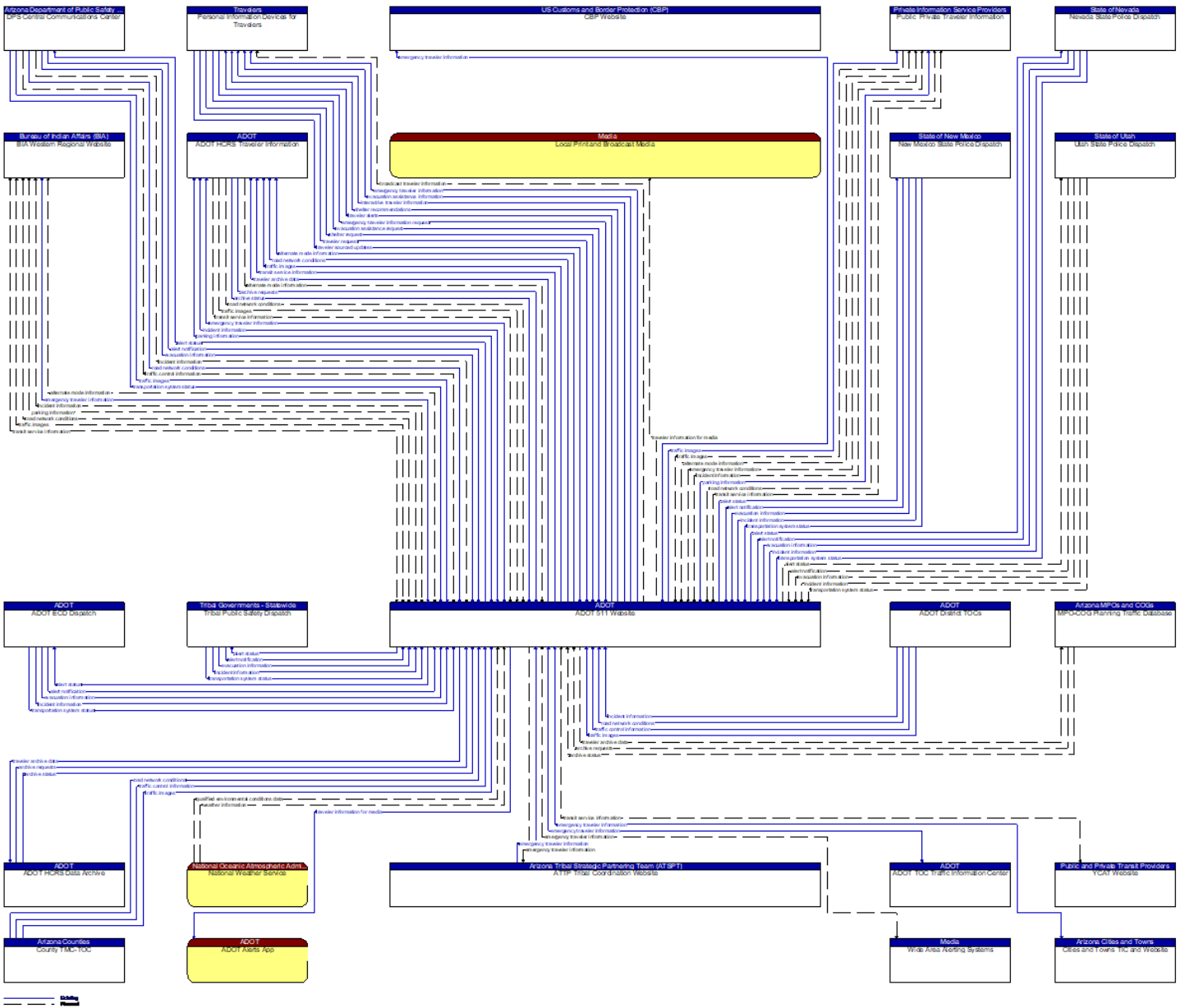

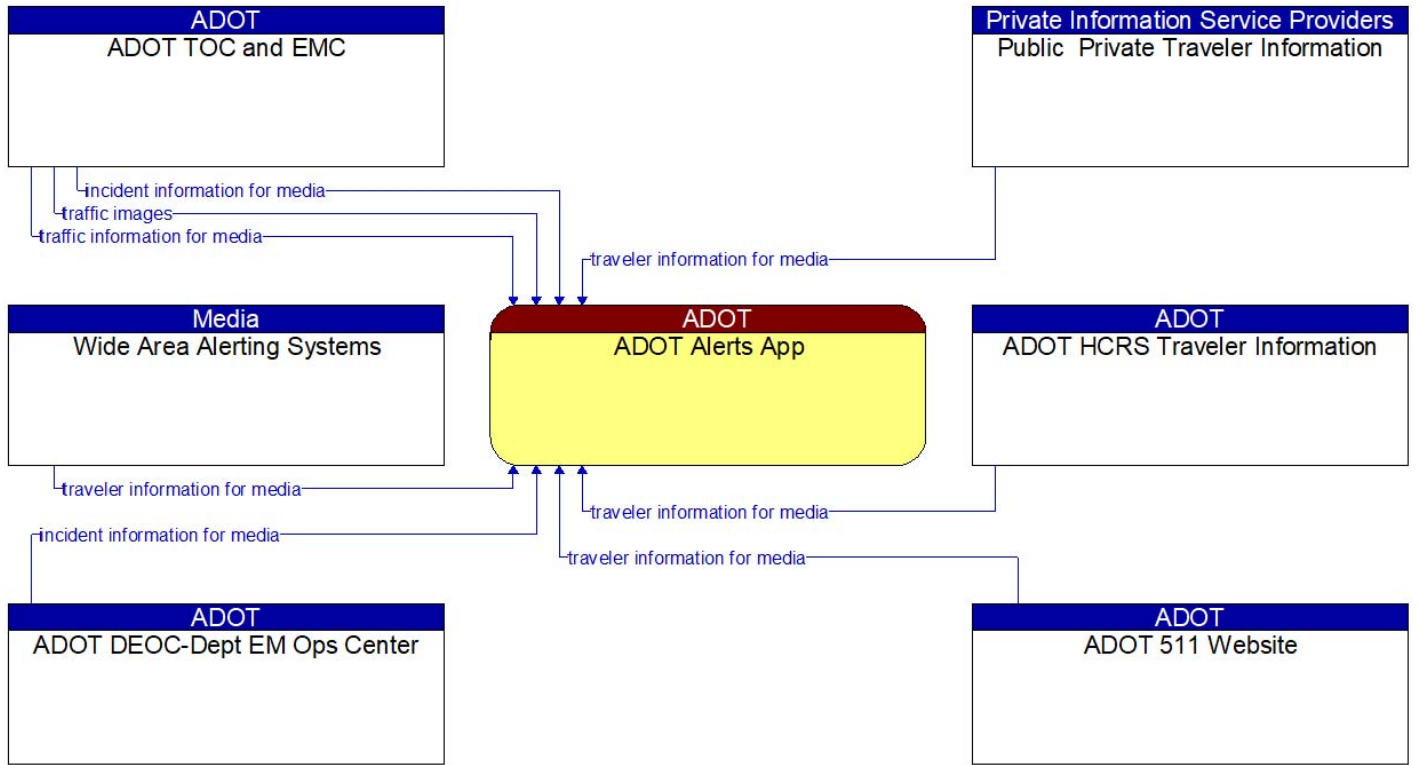

Existing

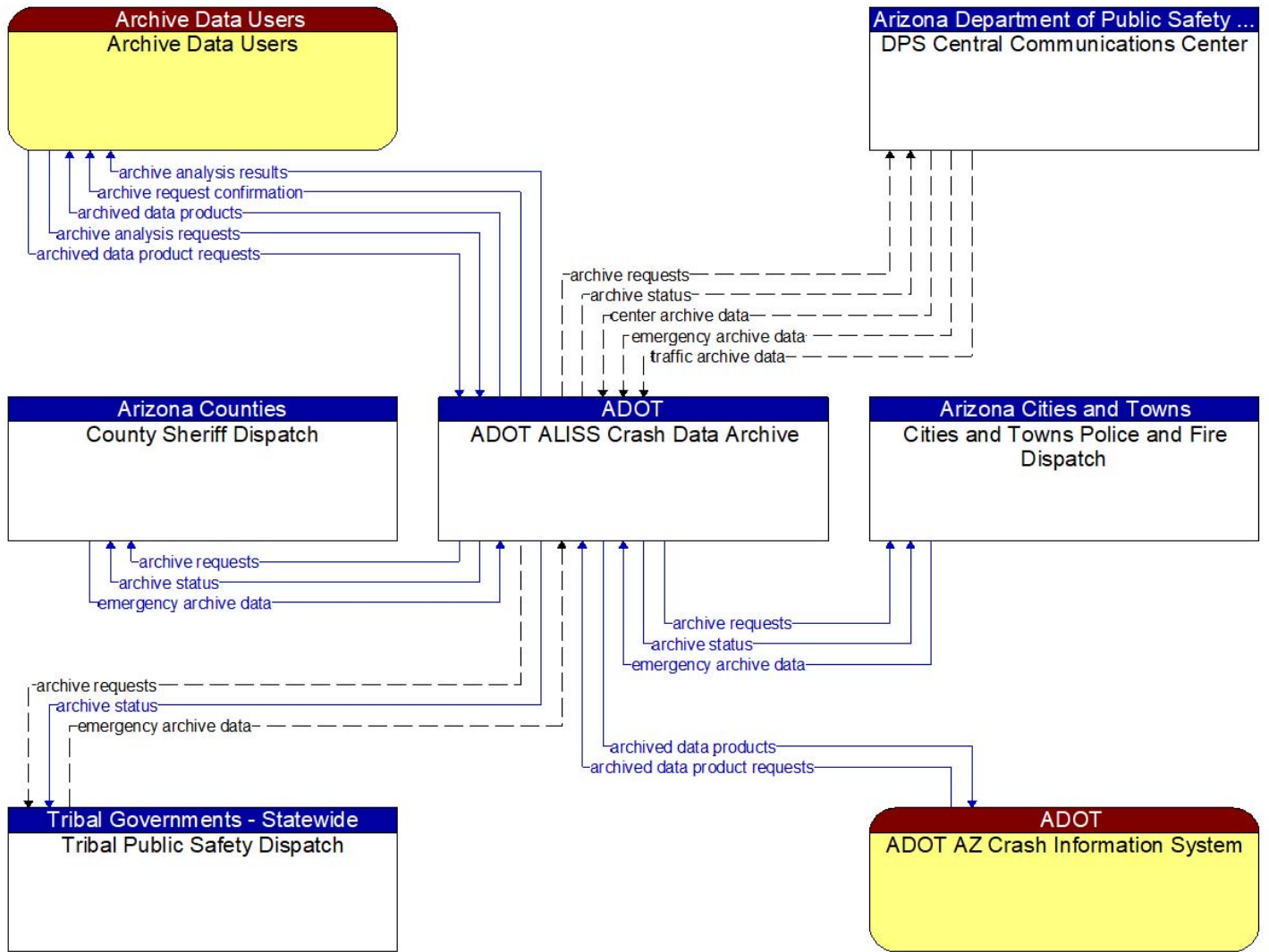

— Existing
 - - - Planned

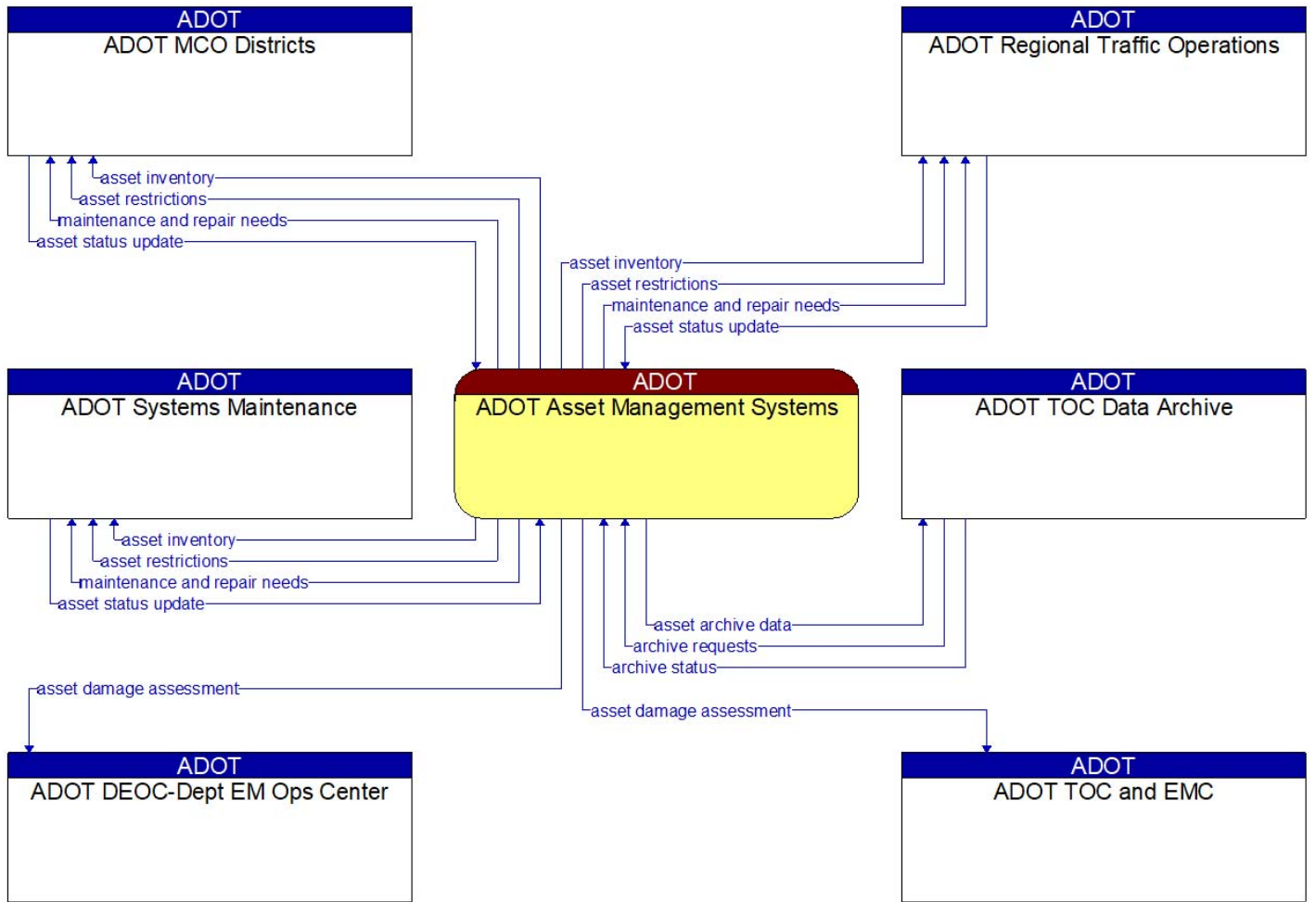

Existing

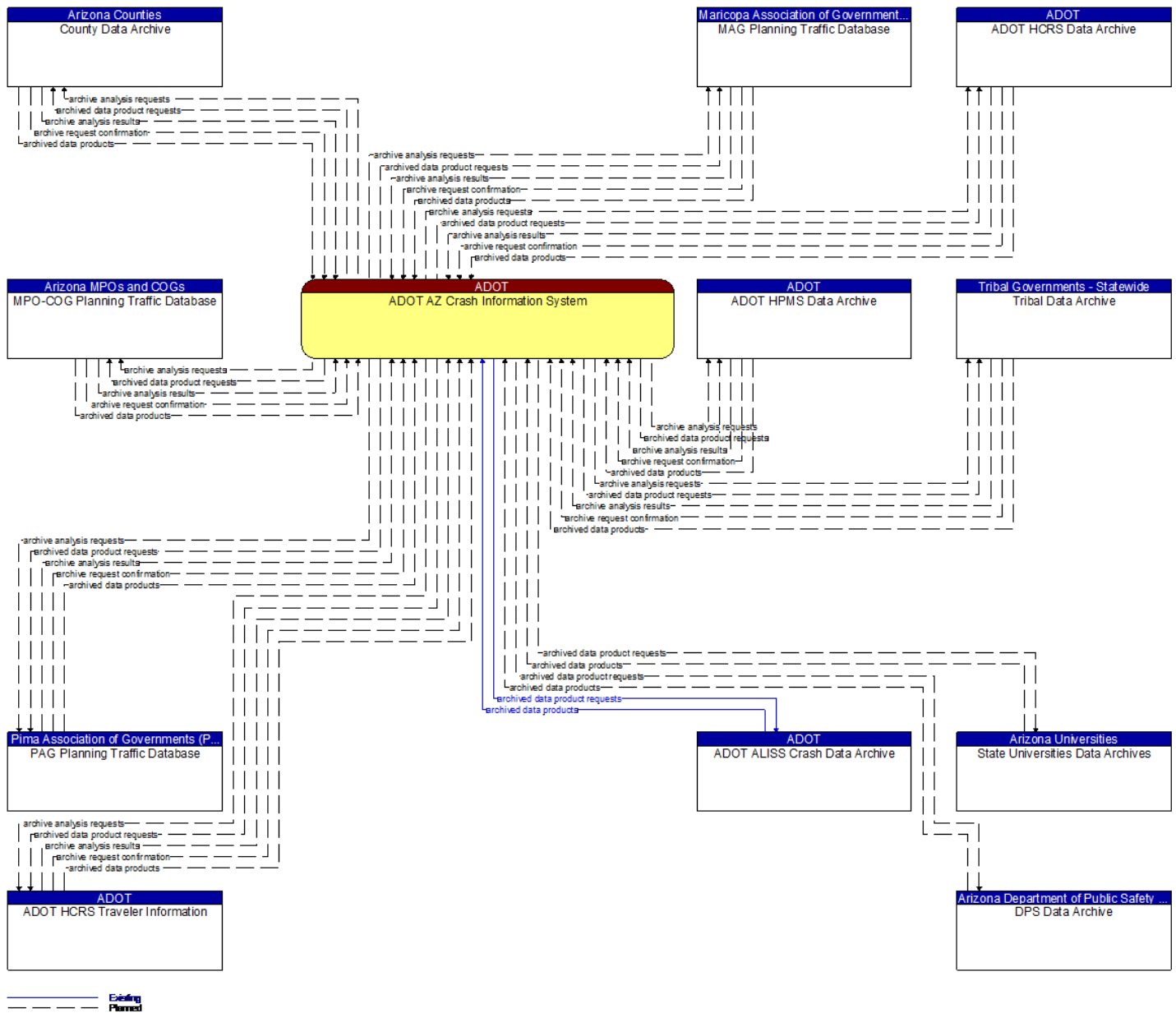

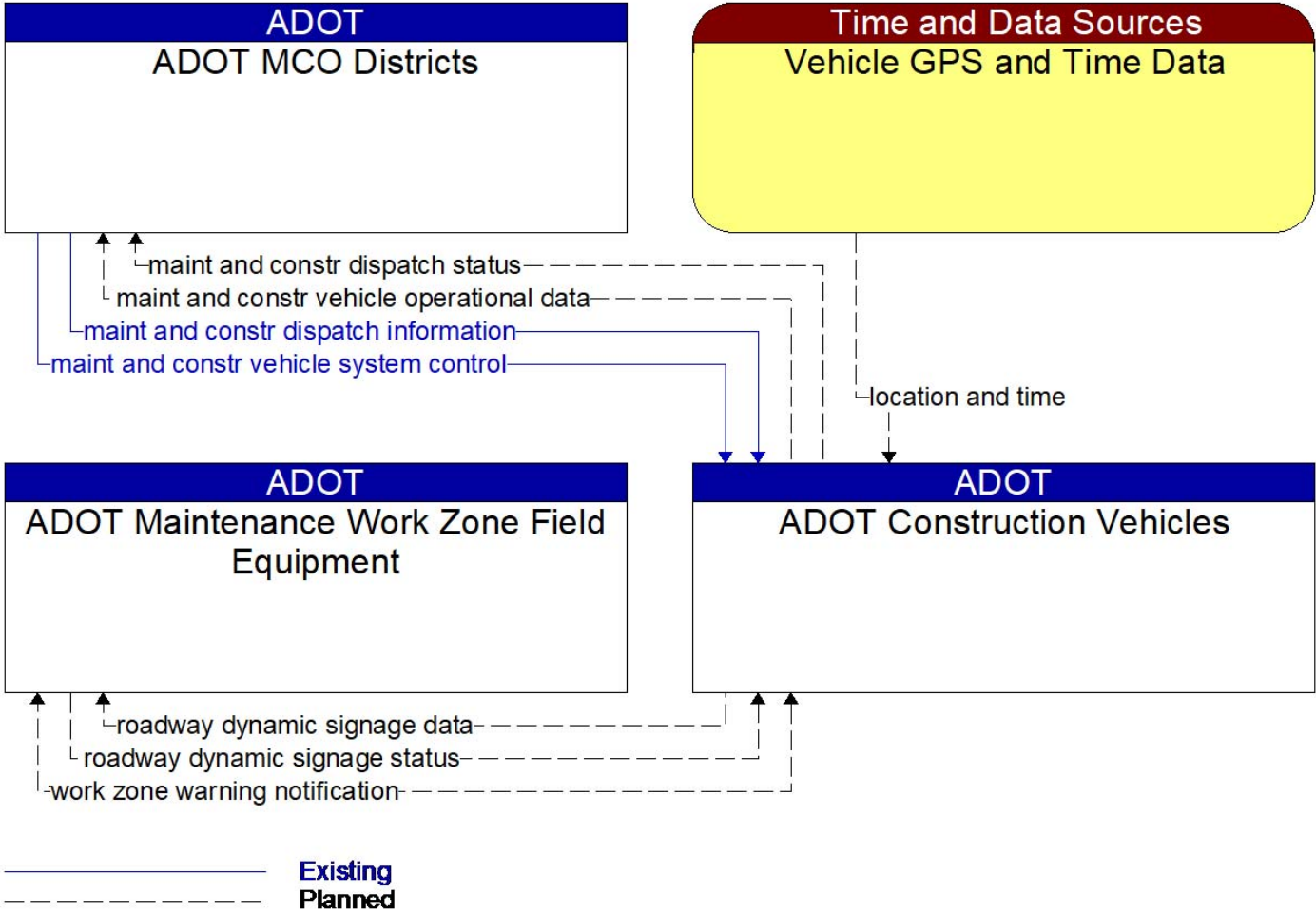

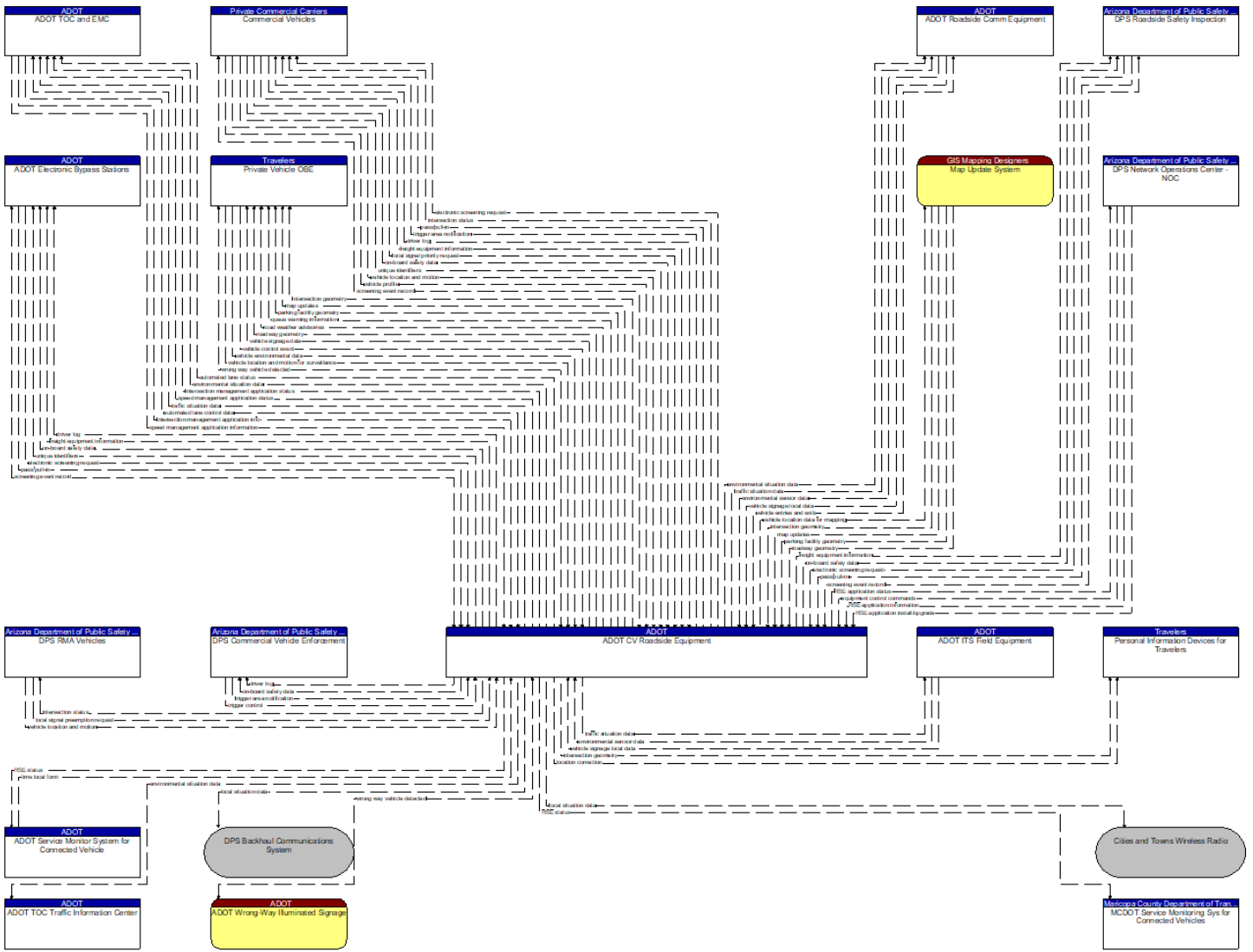

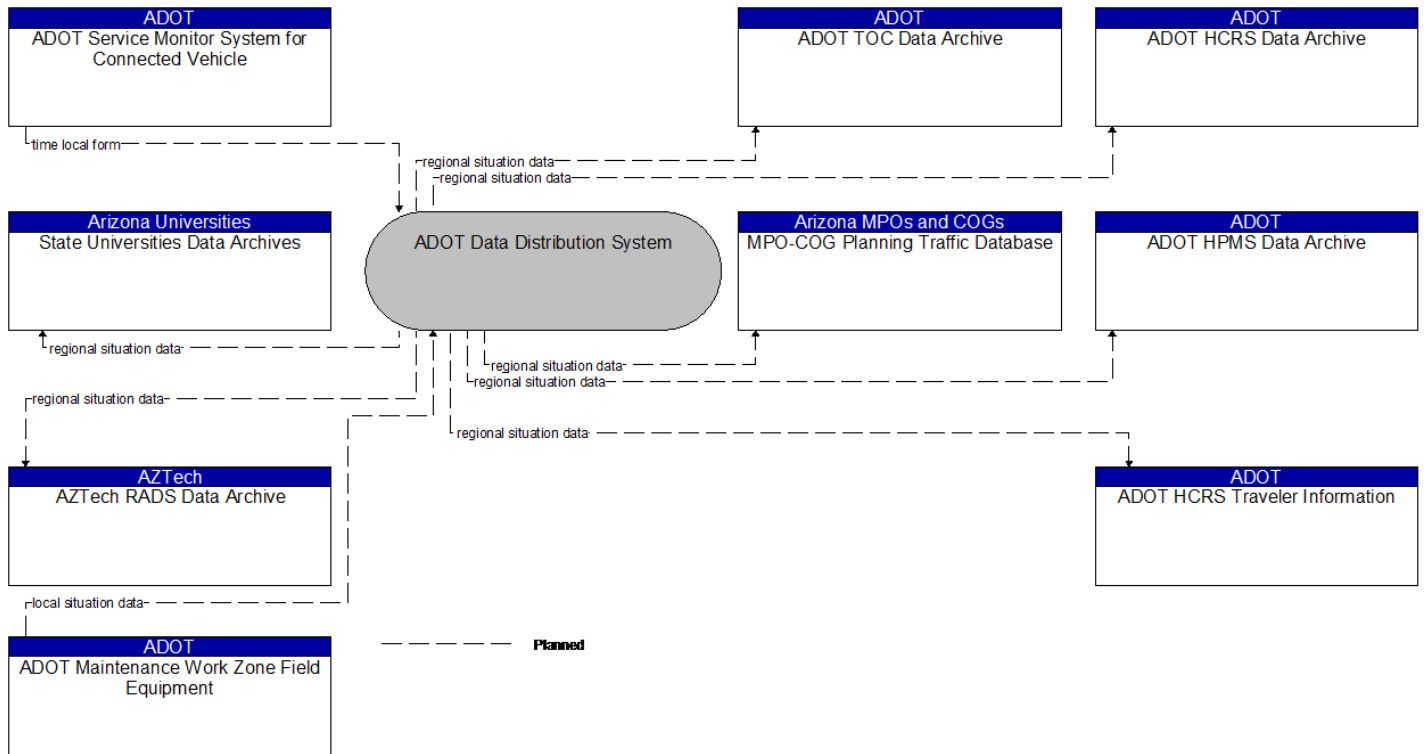

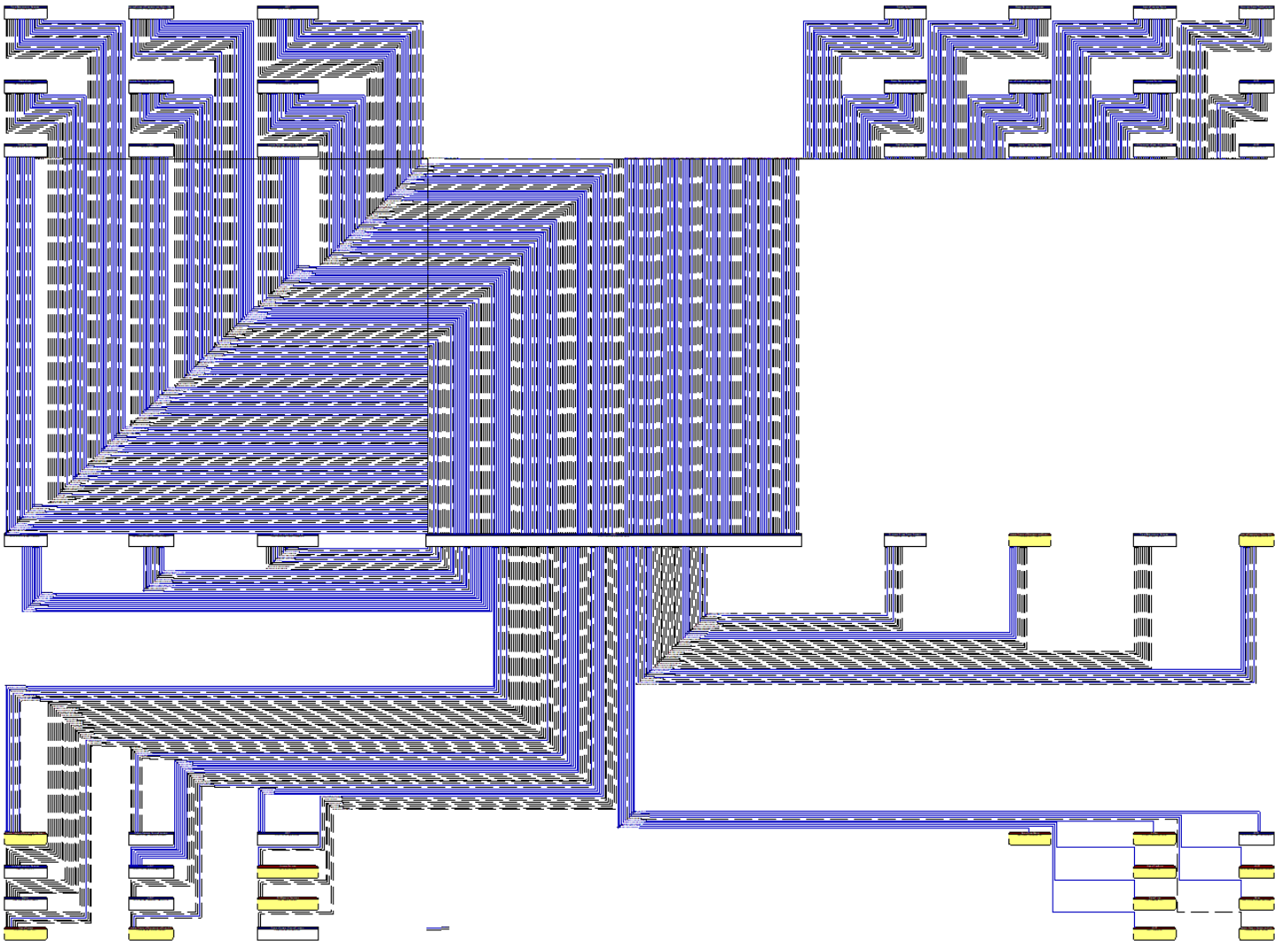

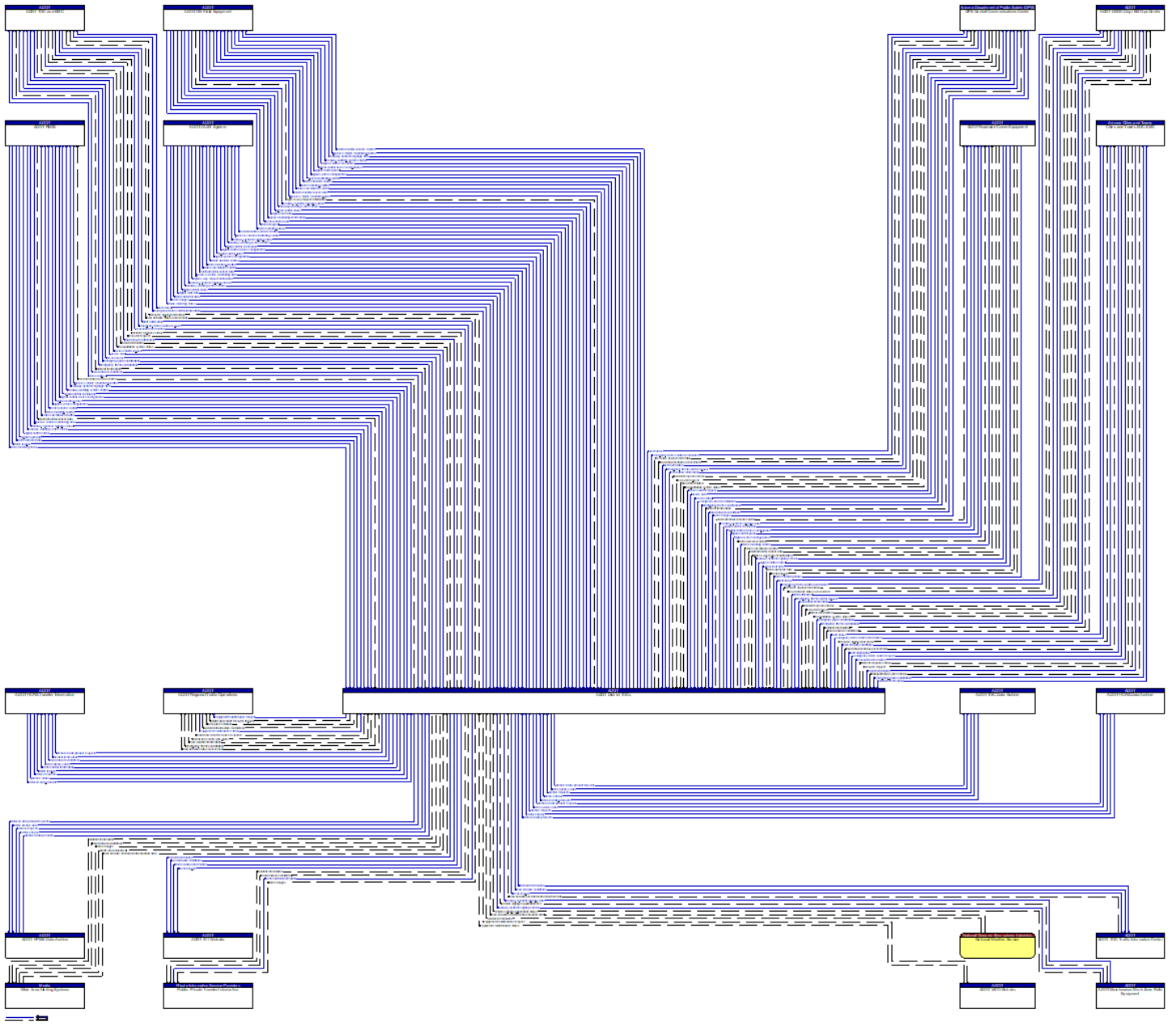

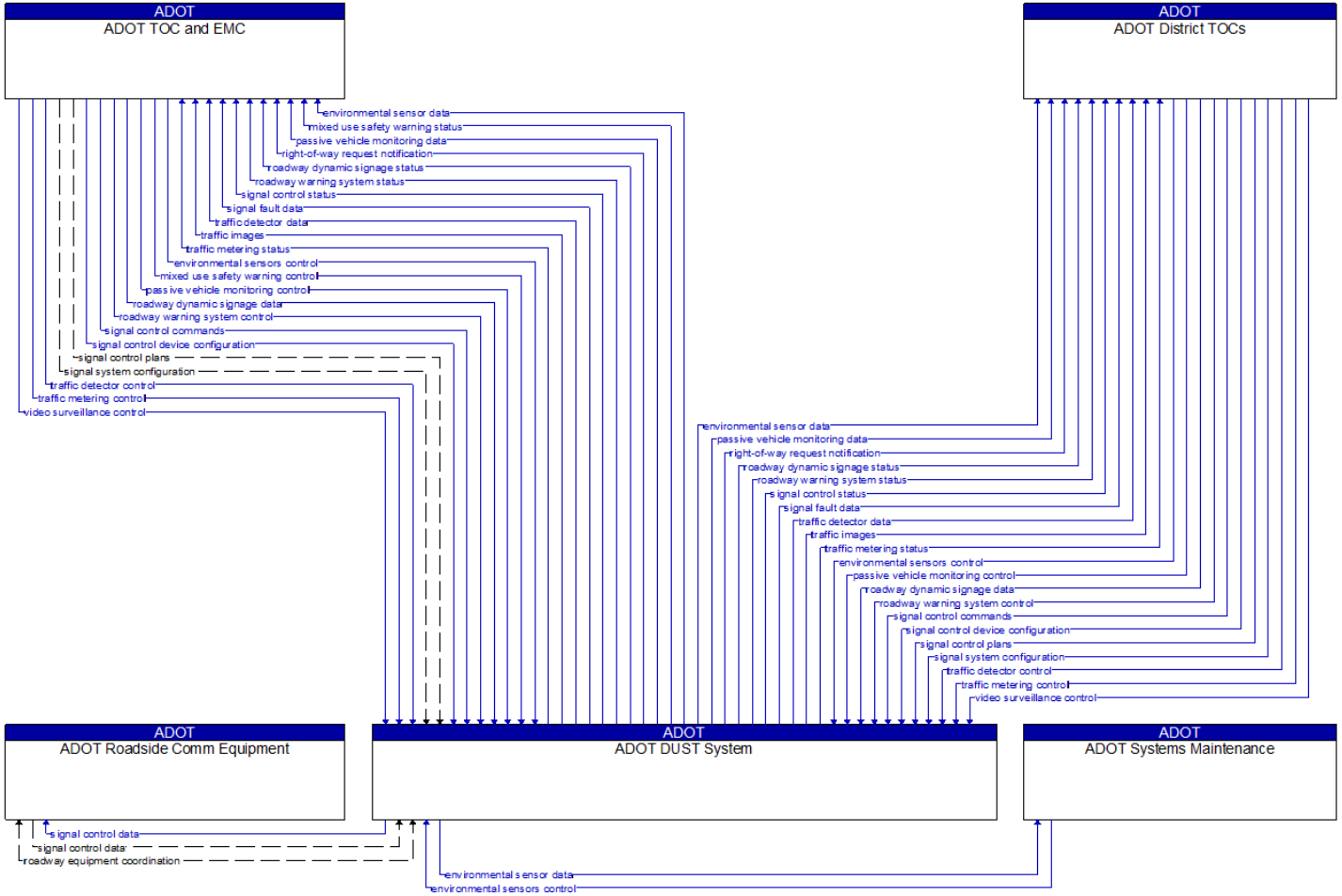

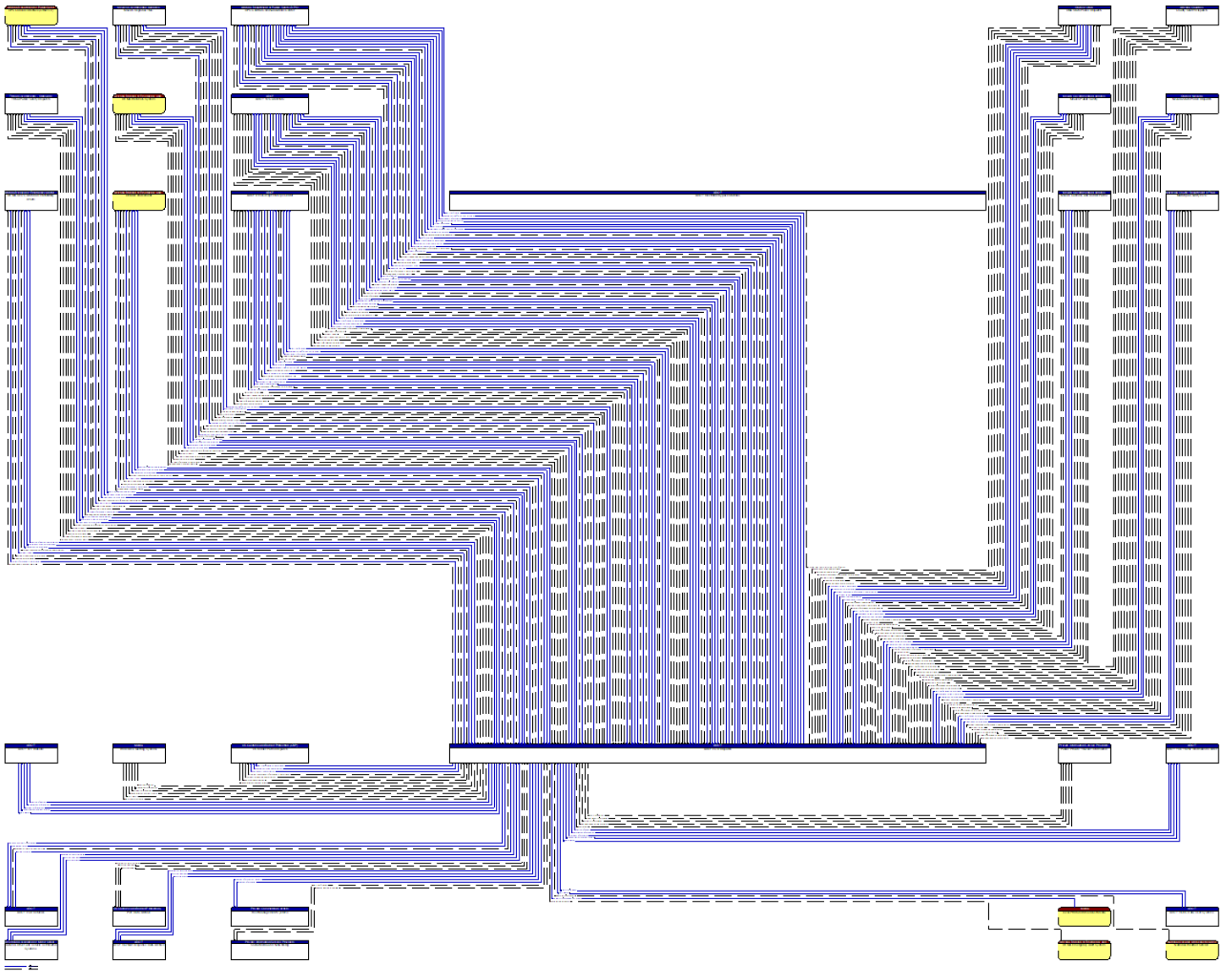

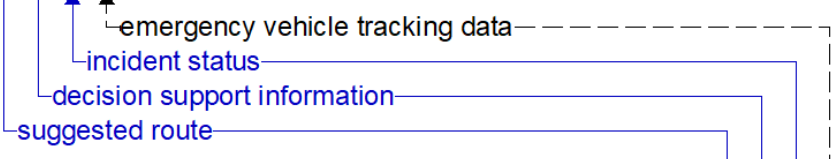
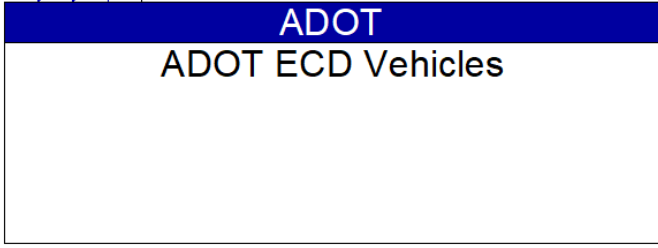
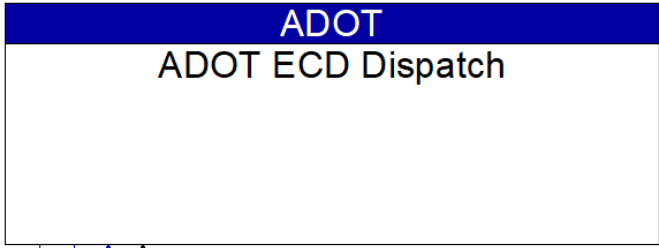

———— Existing
----- Planned

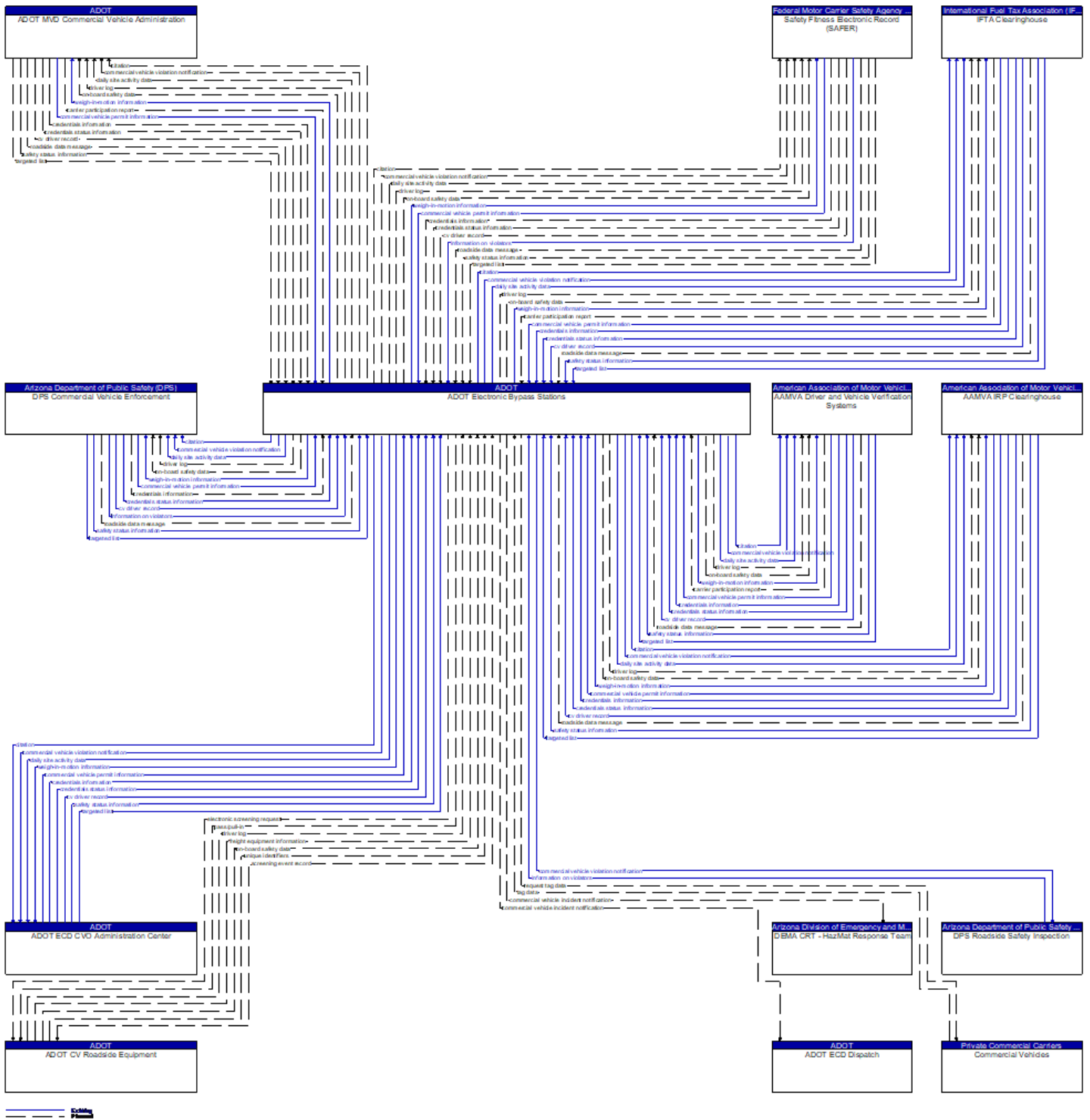

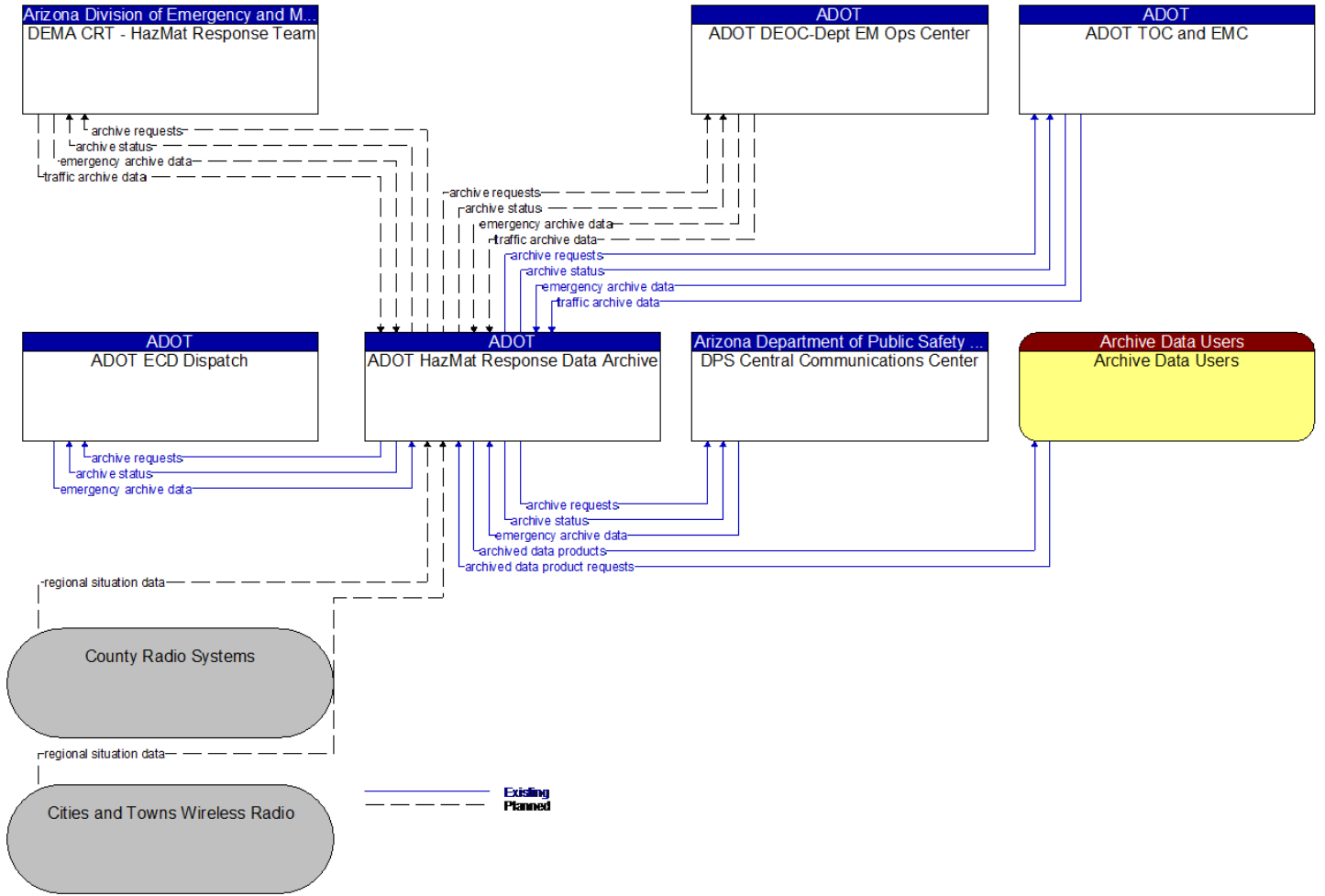

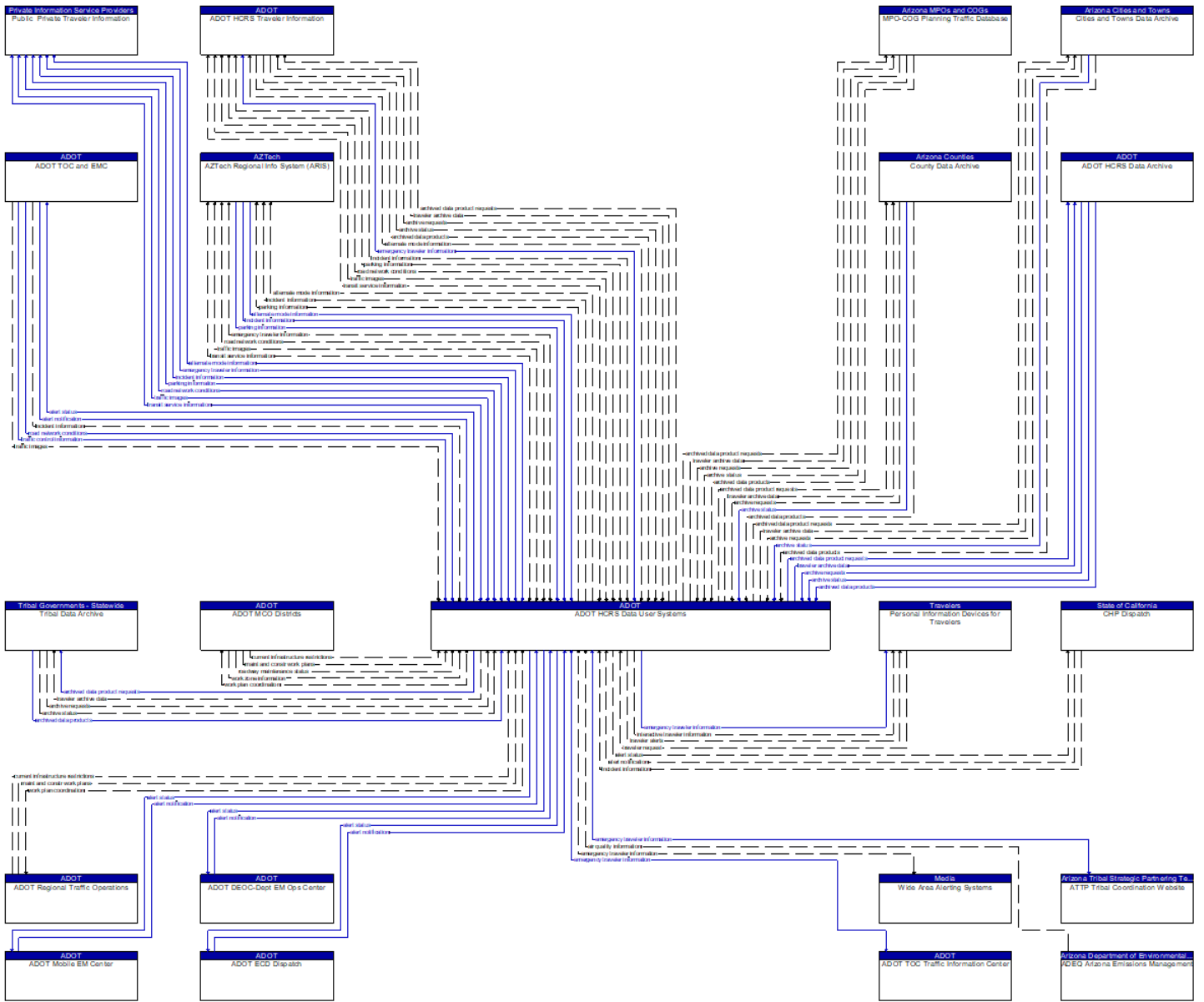

——— Security
- - - - Business

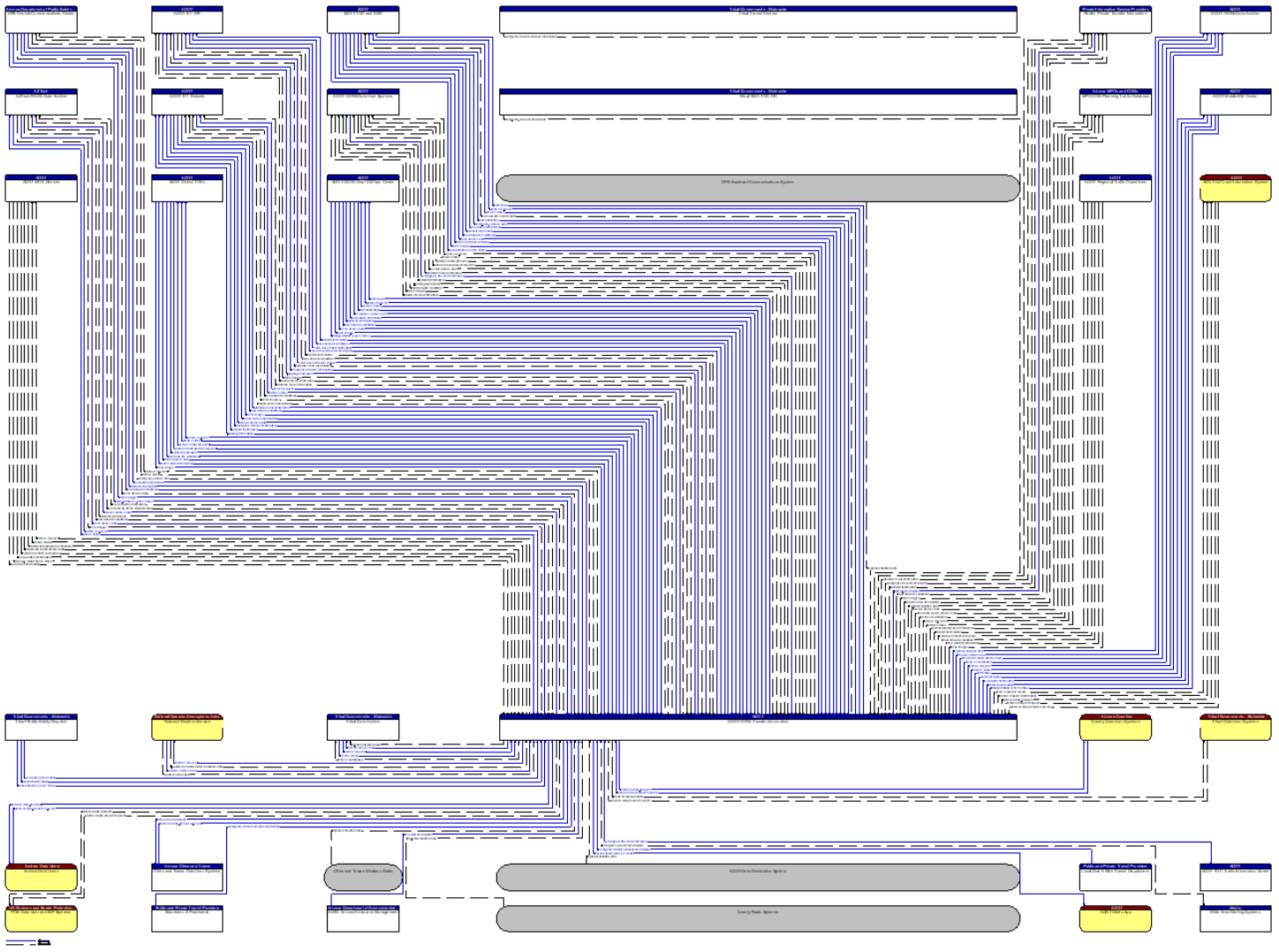

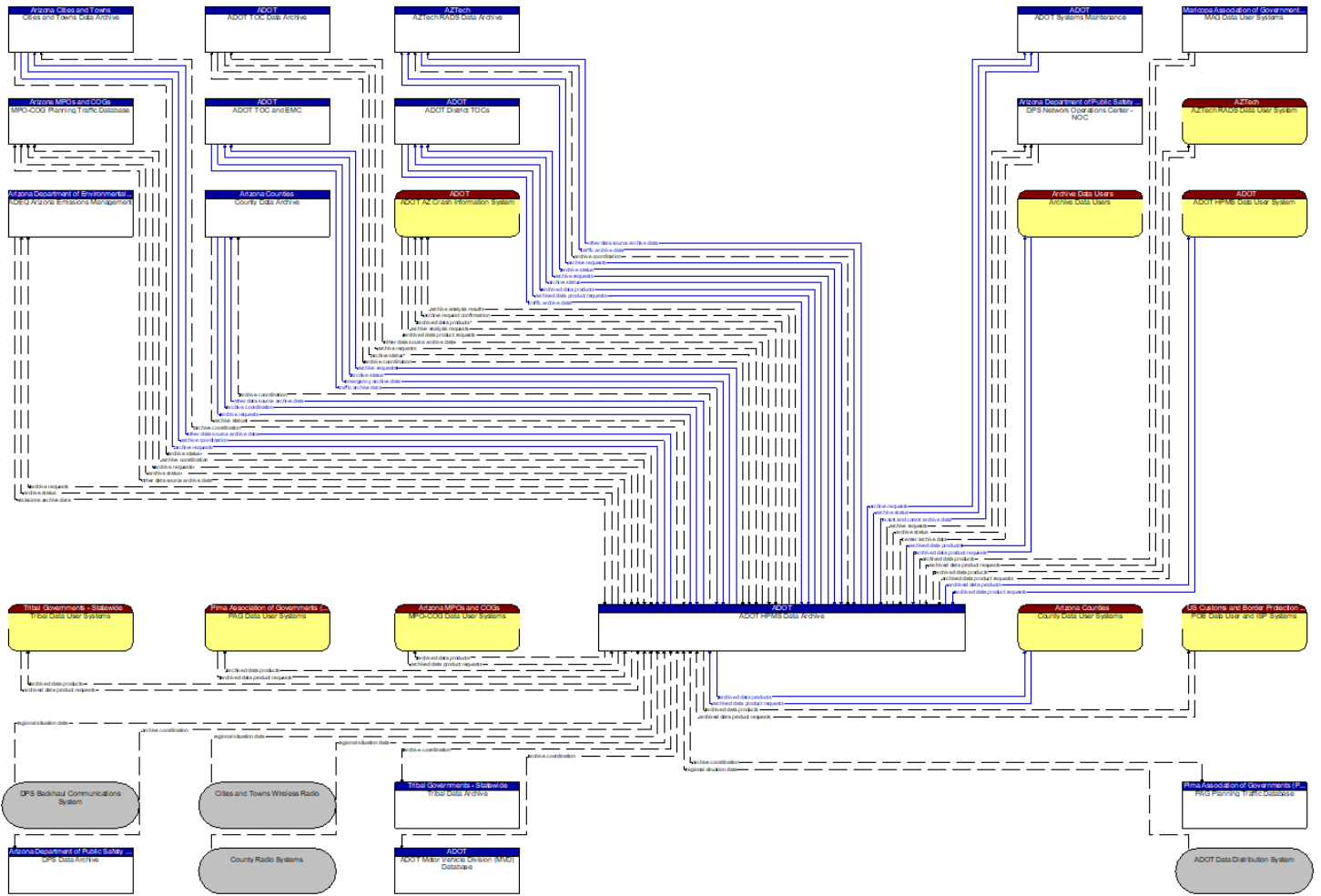

— Solid Blue Line
 - - - - - Dashed Line

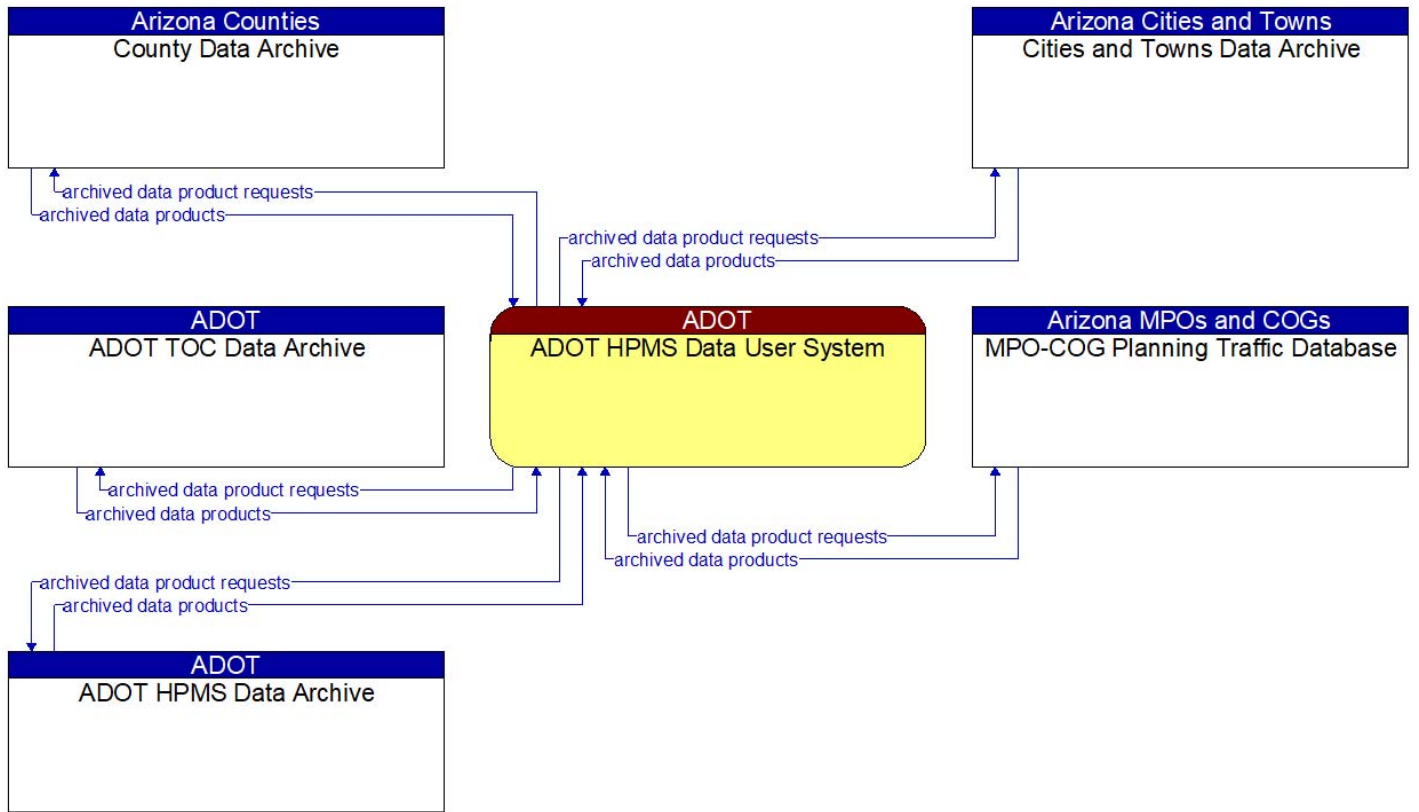

———— Existing

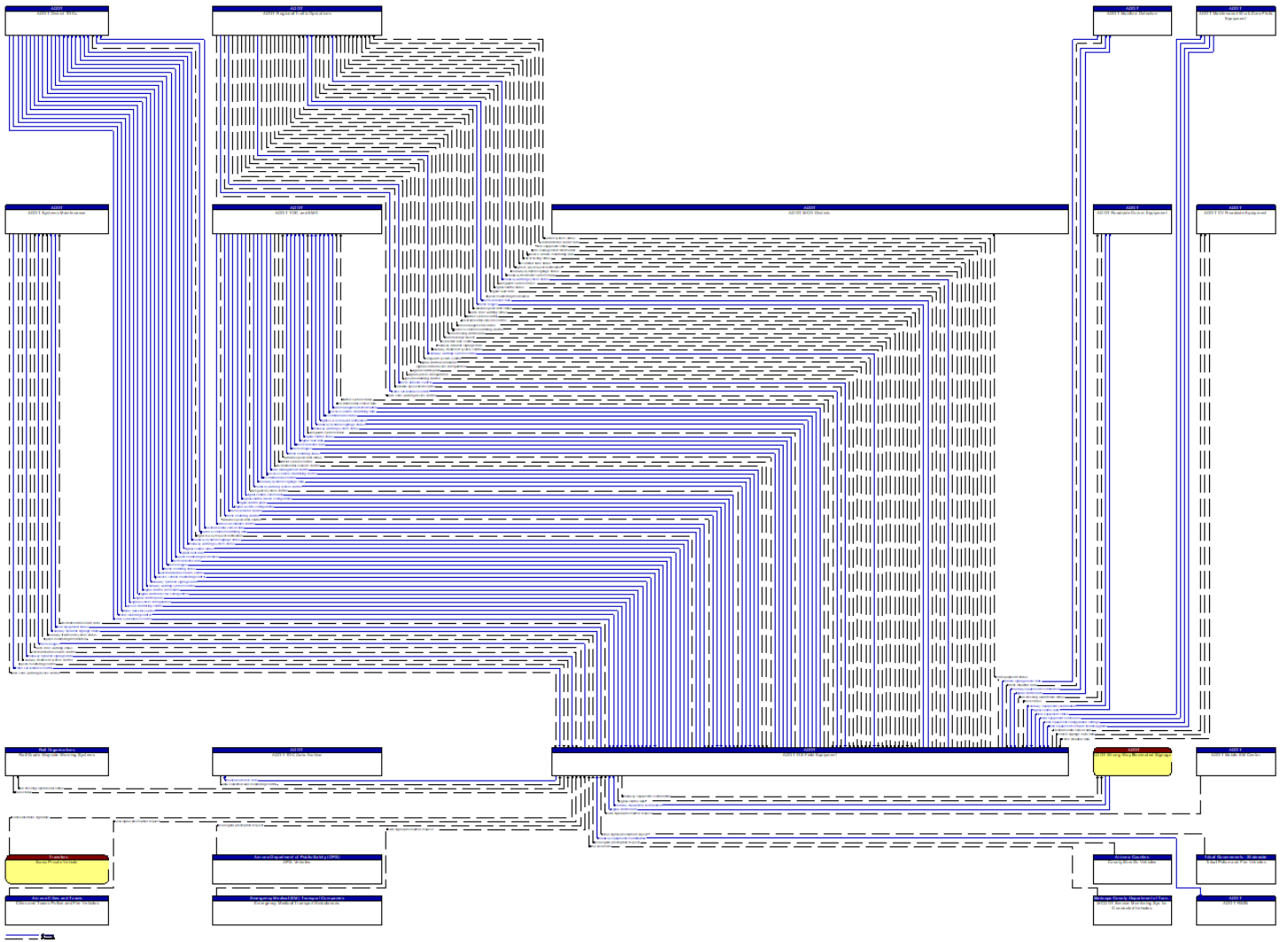

AZTech
AZTech RADS Data Archive



ADOT
ADOT TOC and EMC

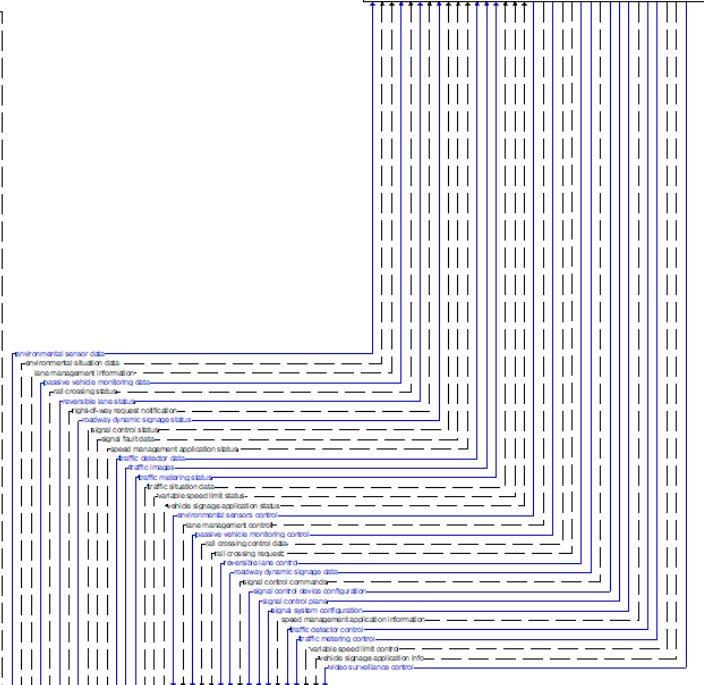

ADOT
ADOT Roadside Comm Equipment

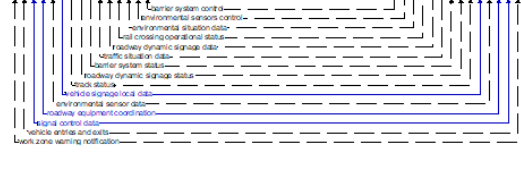

ADOT
ADOT Mainline Detection

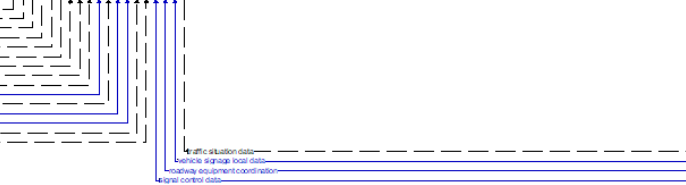

ADOT
ADOT ITS Field Equipment



— Existing
- - - Planned

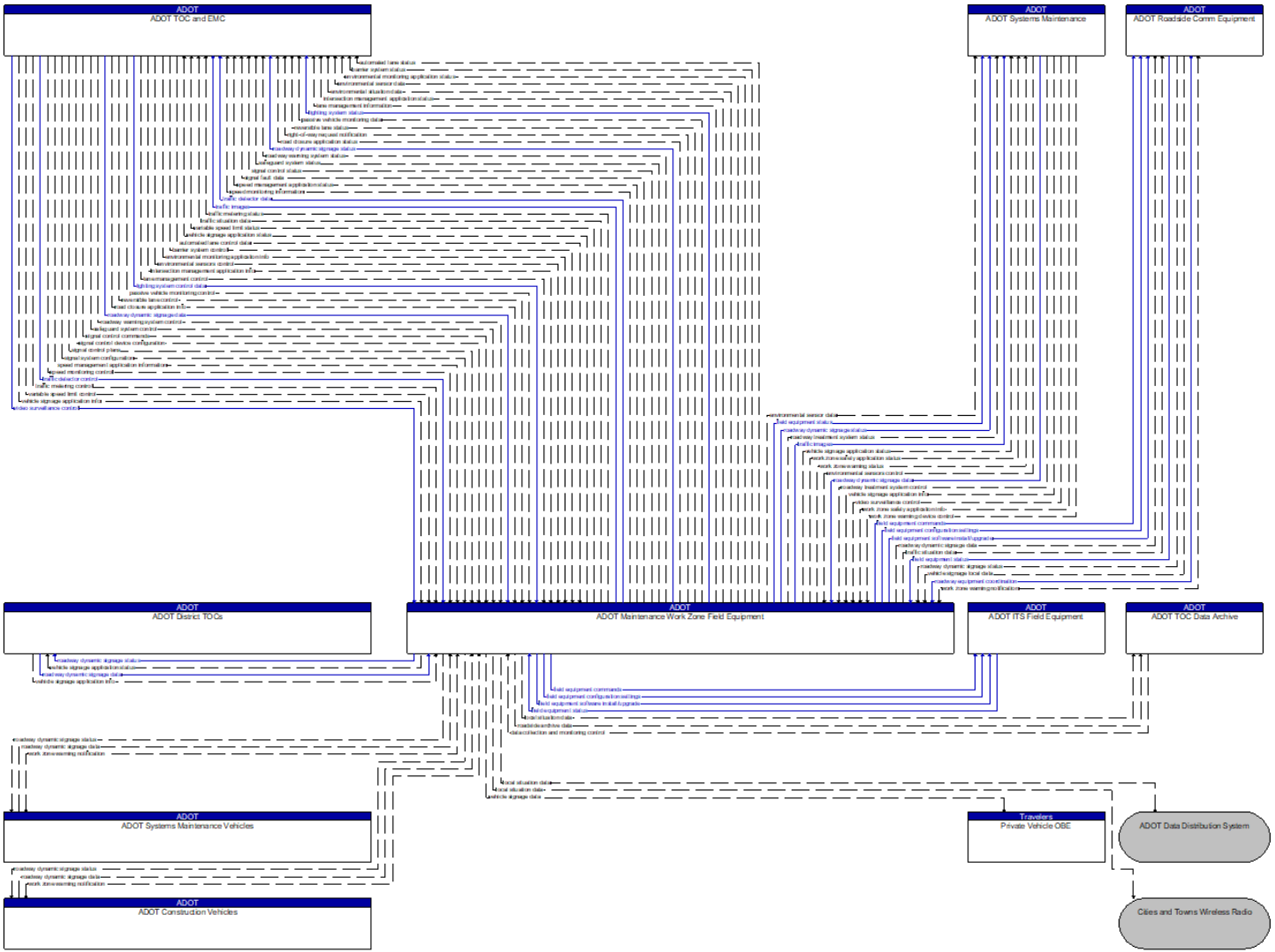

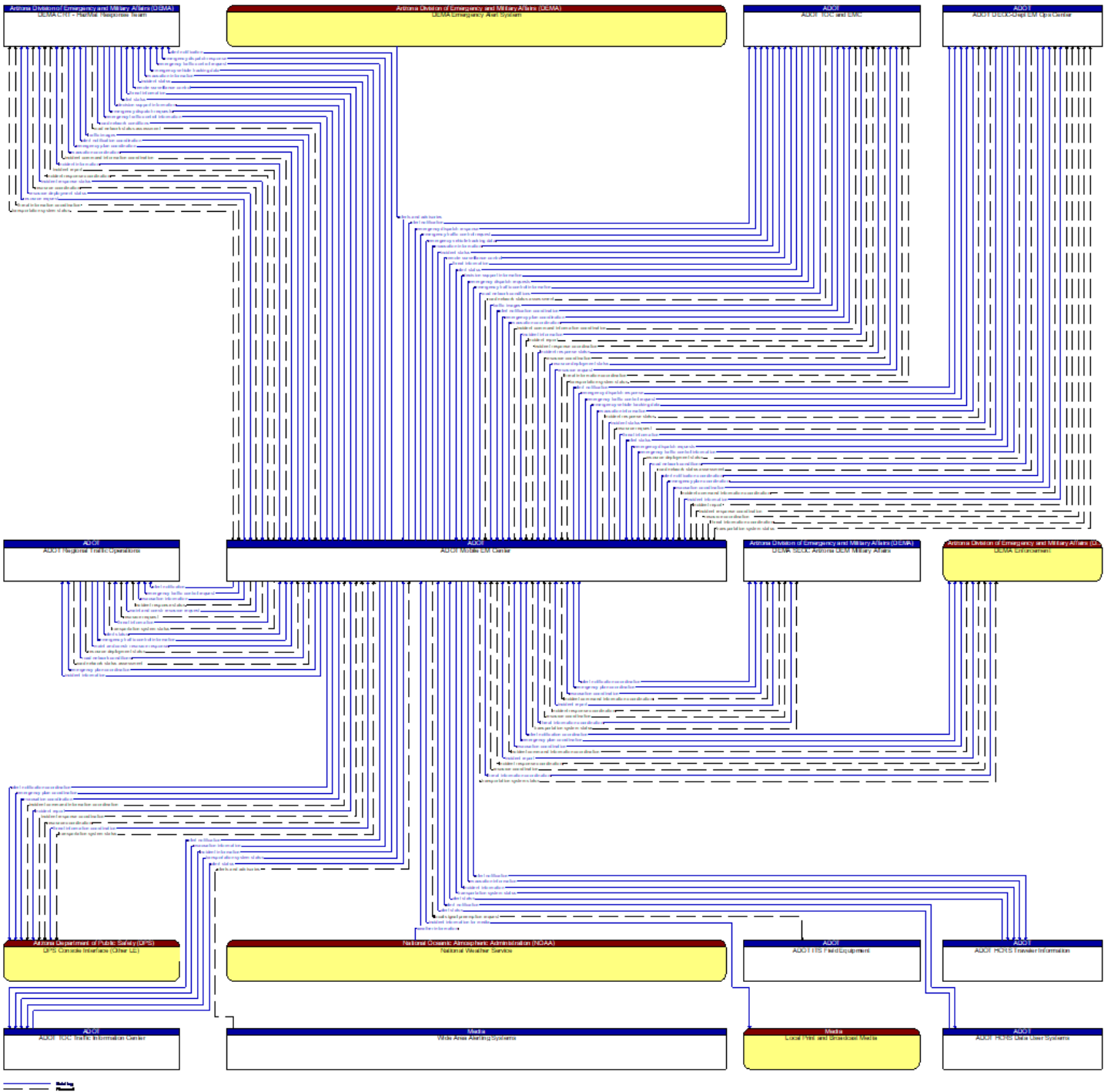

— ADCE
- - - ADOT

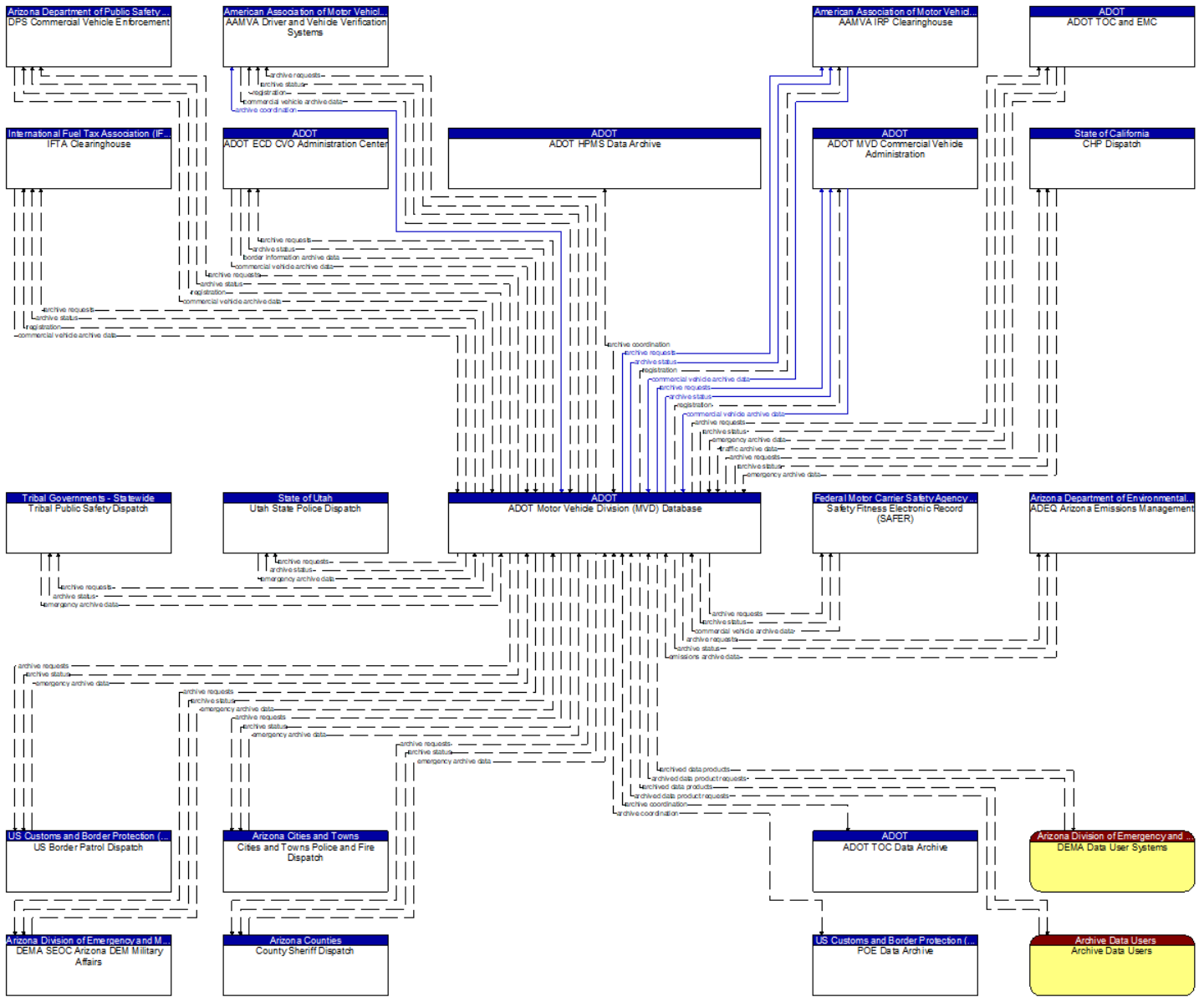

Existing
Planned

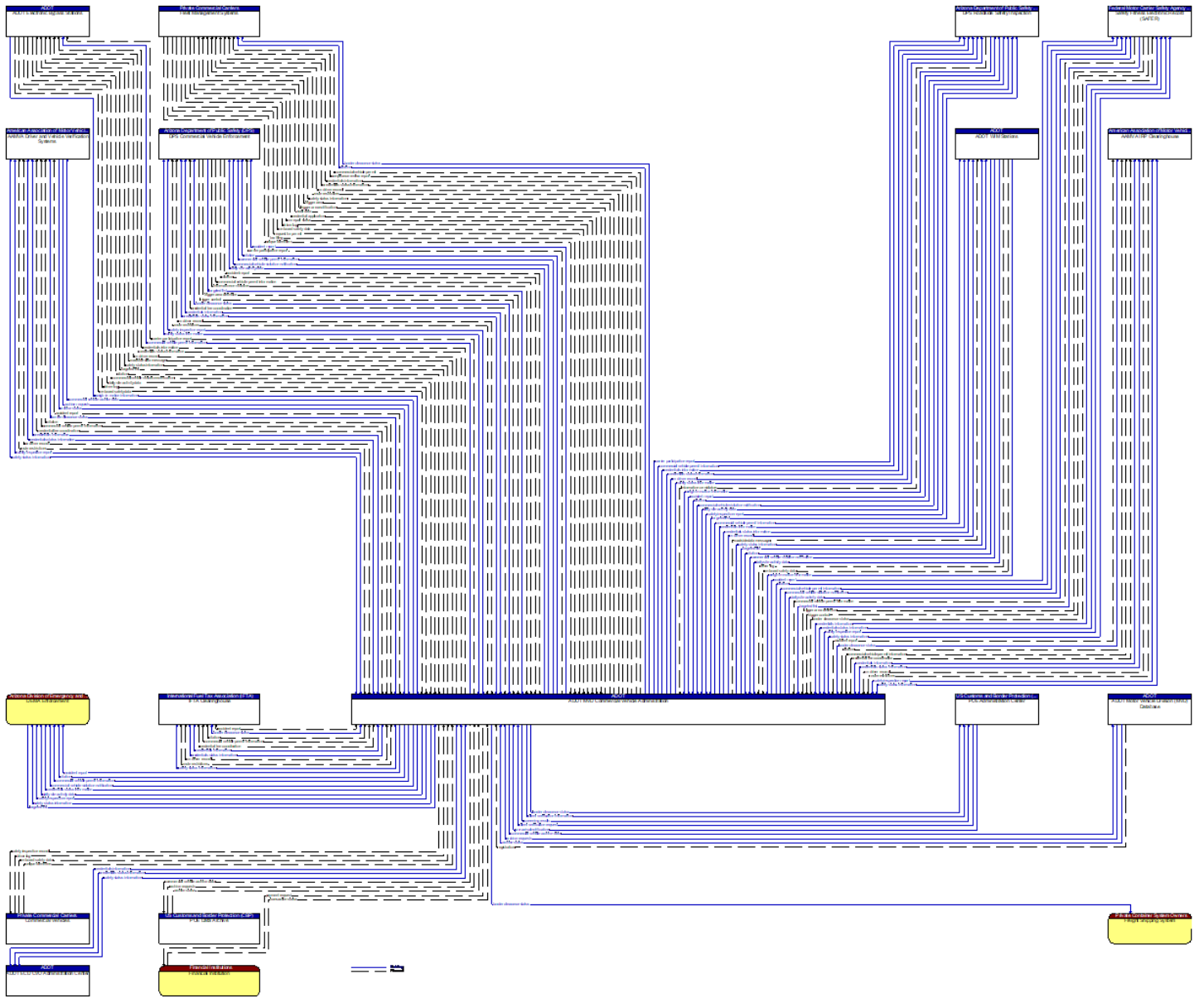

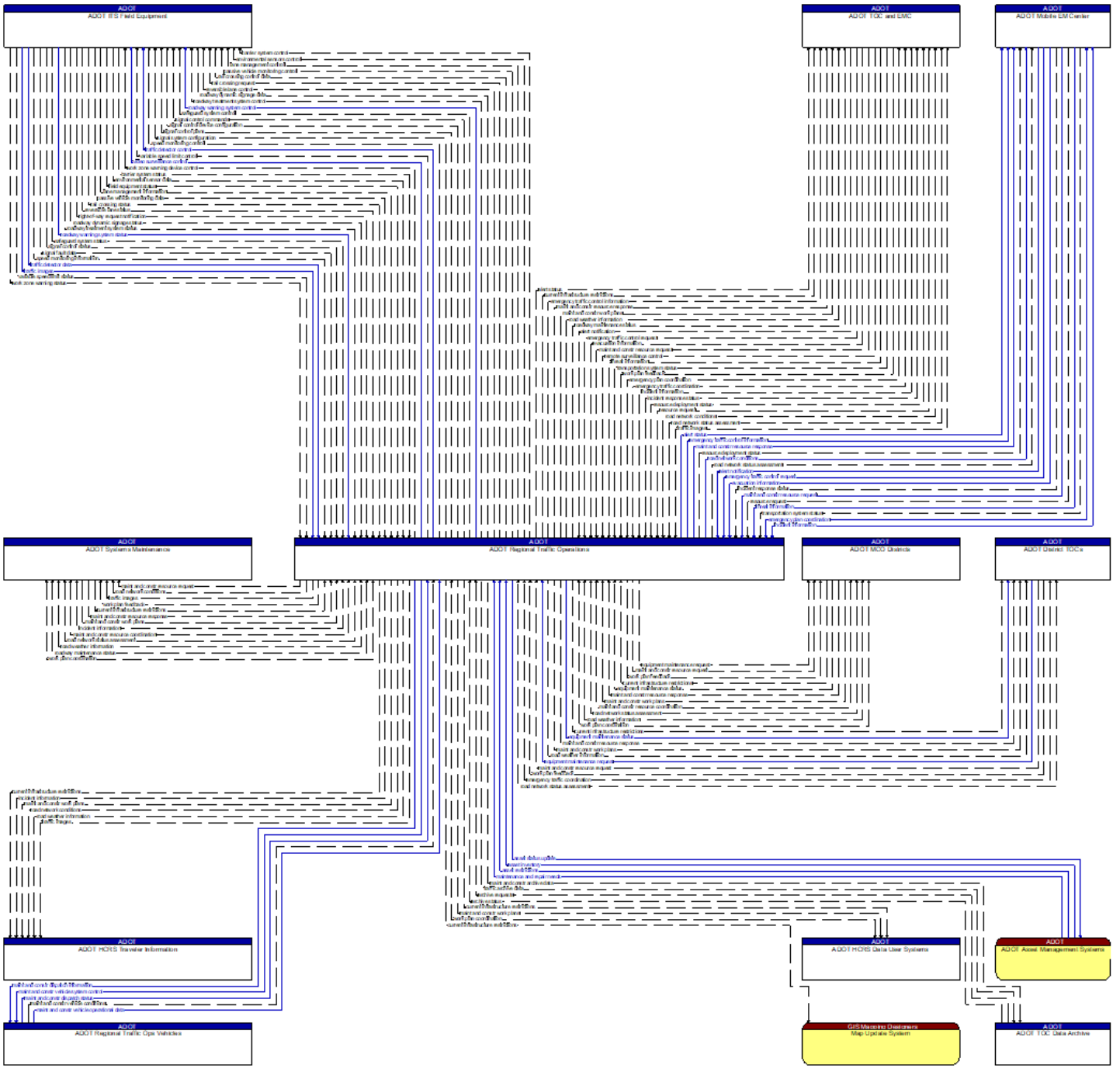

Legend:
 — Data
 - - - Voice

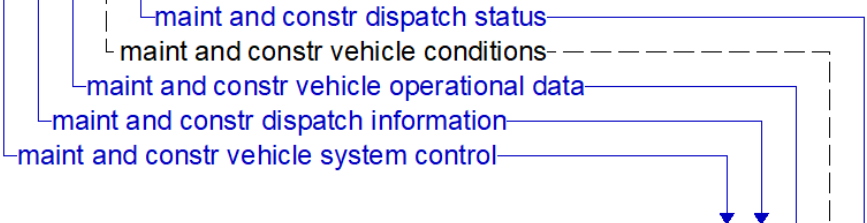
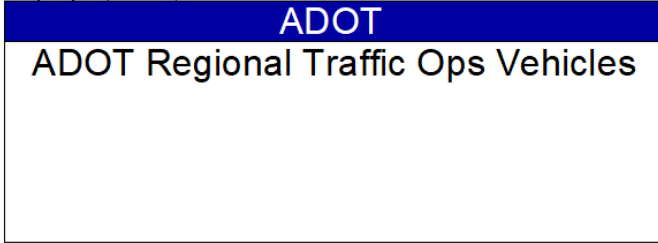
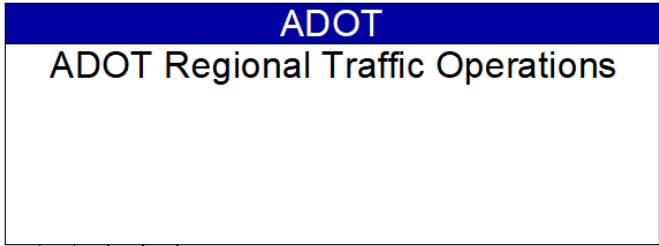

———— Existing
----- Planned

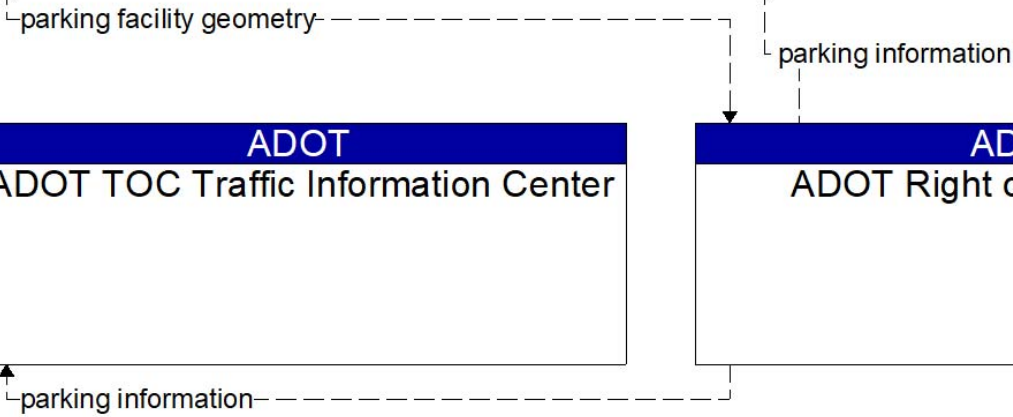
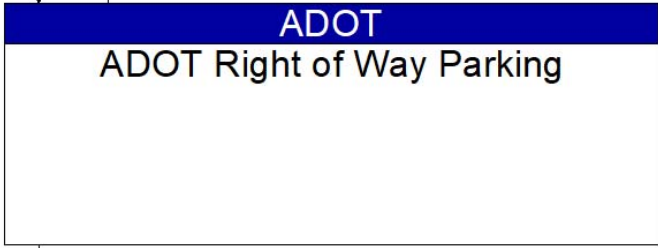
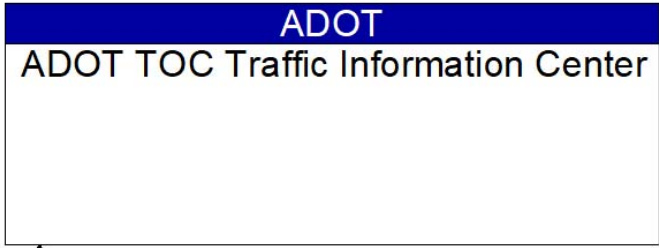
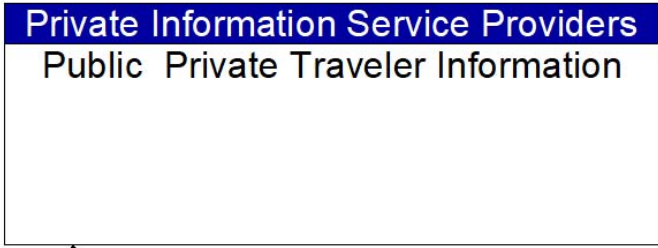
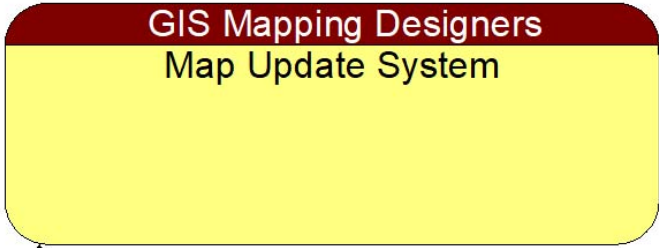

----- Planned

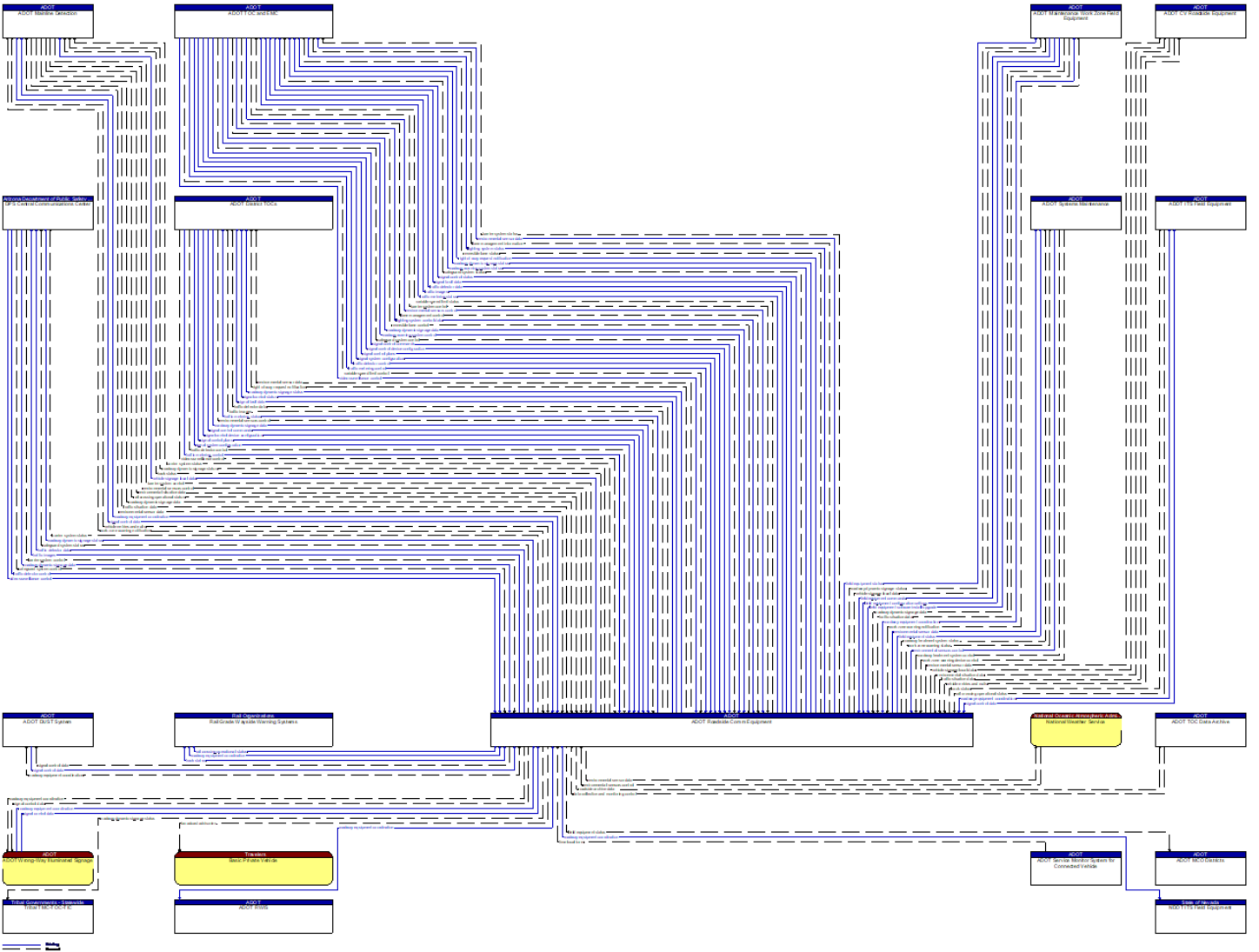

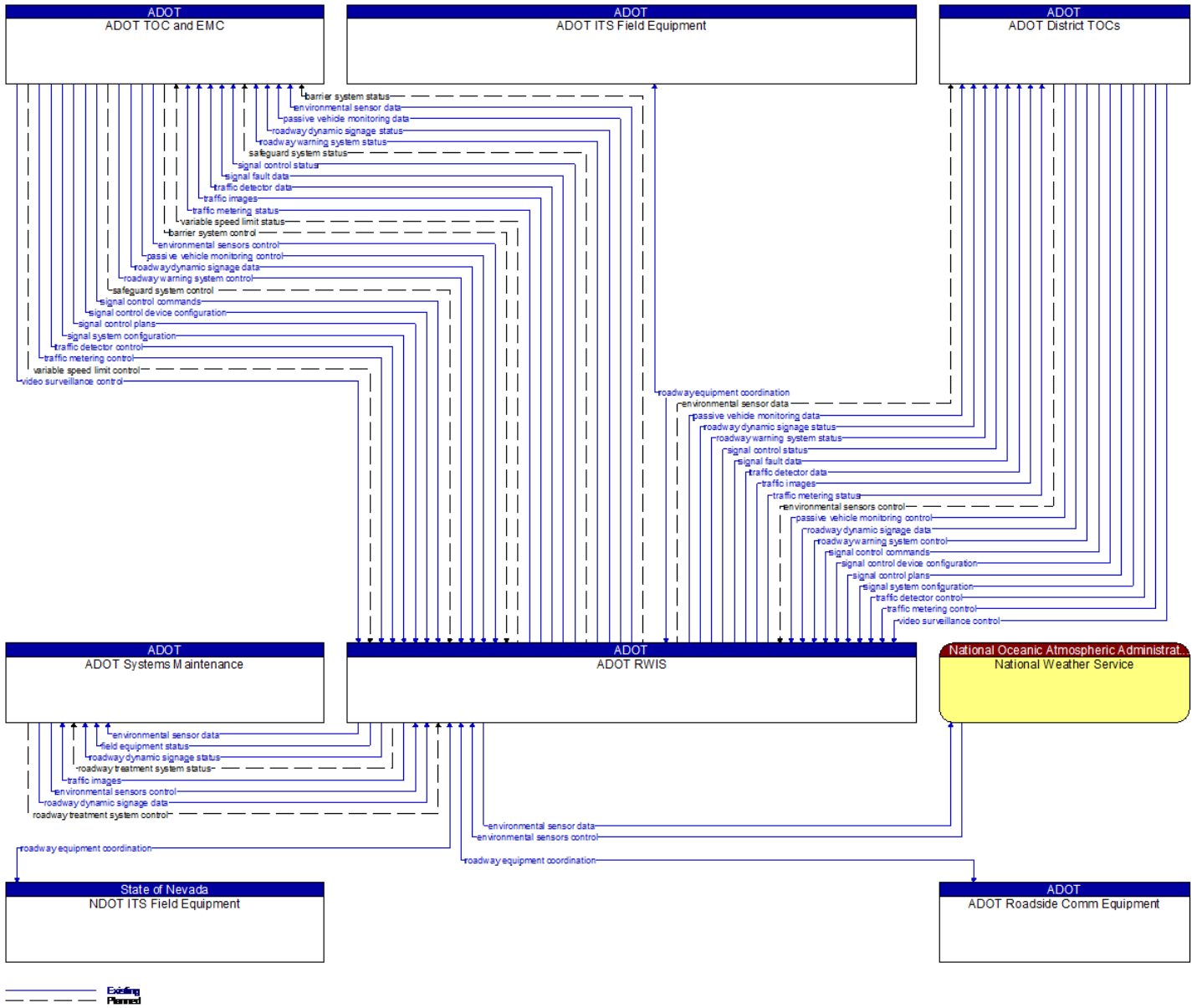

Existing
 Planned

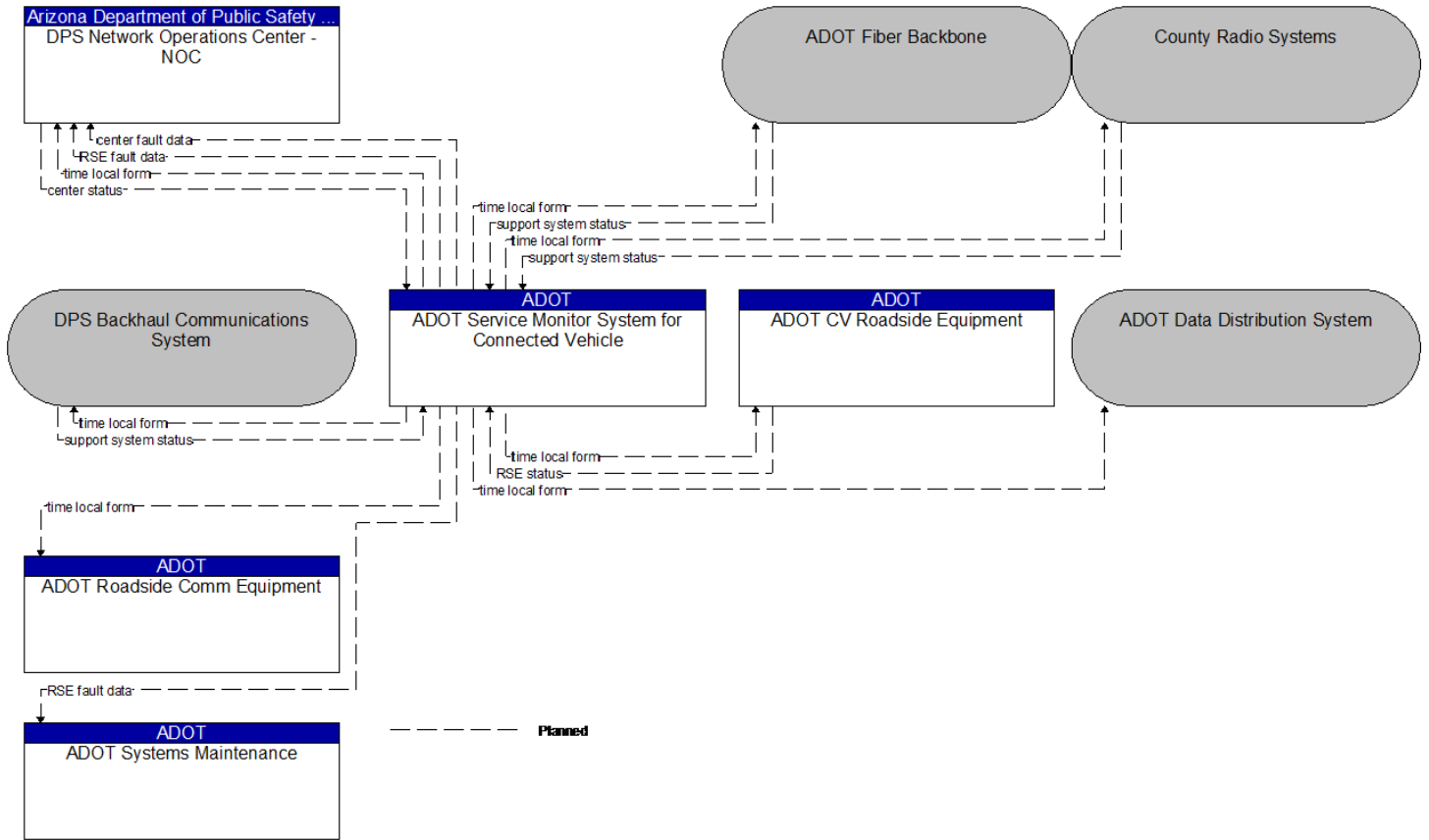

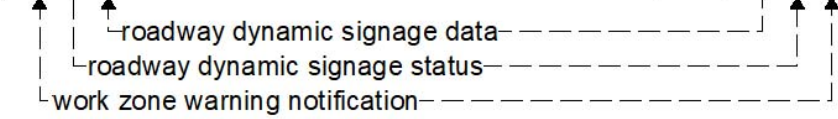
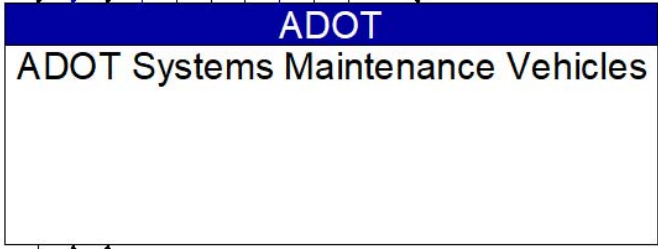
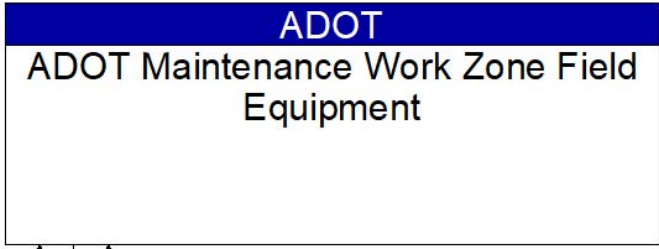
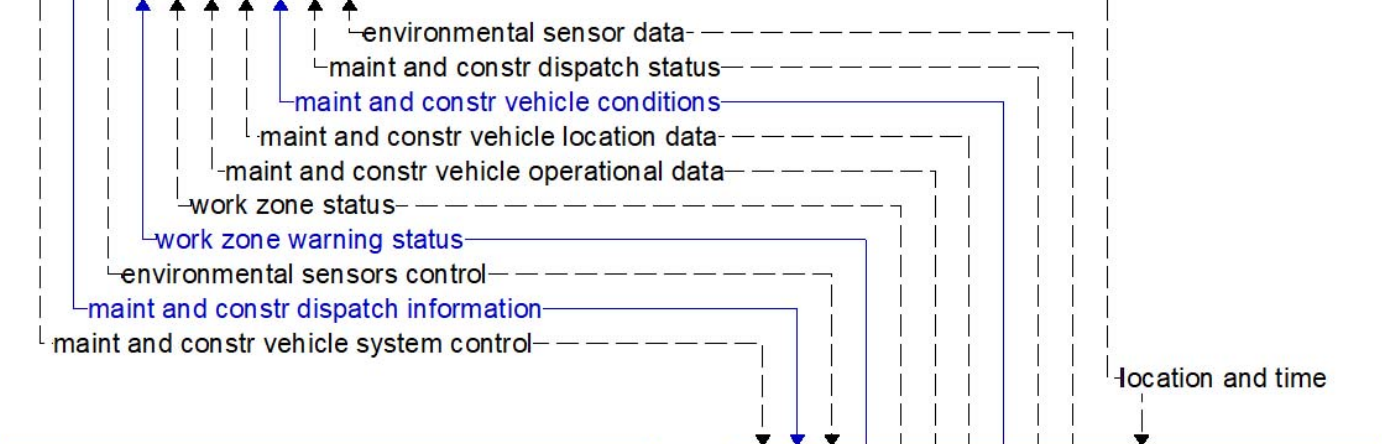
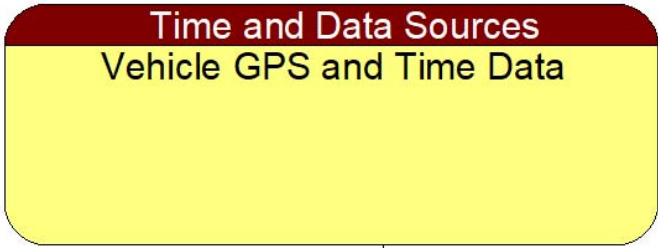
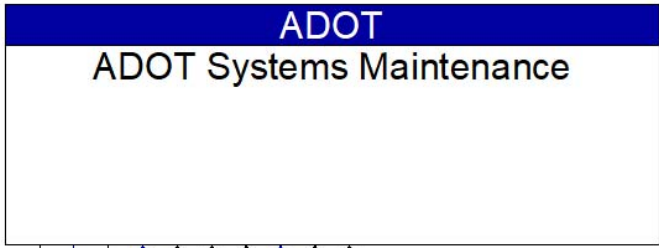

———— Existing
 - - - - - Planned

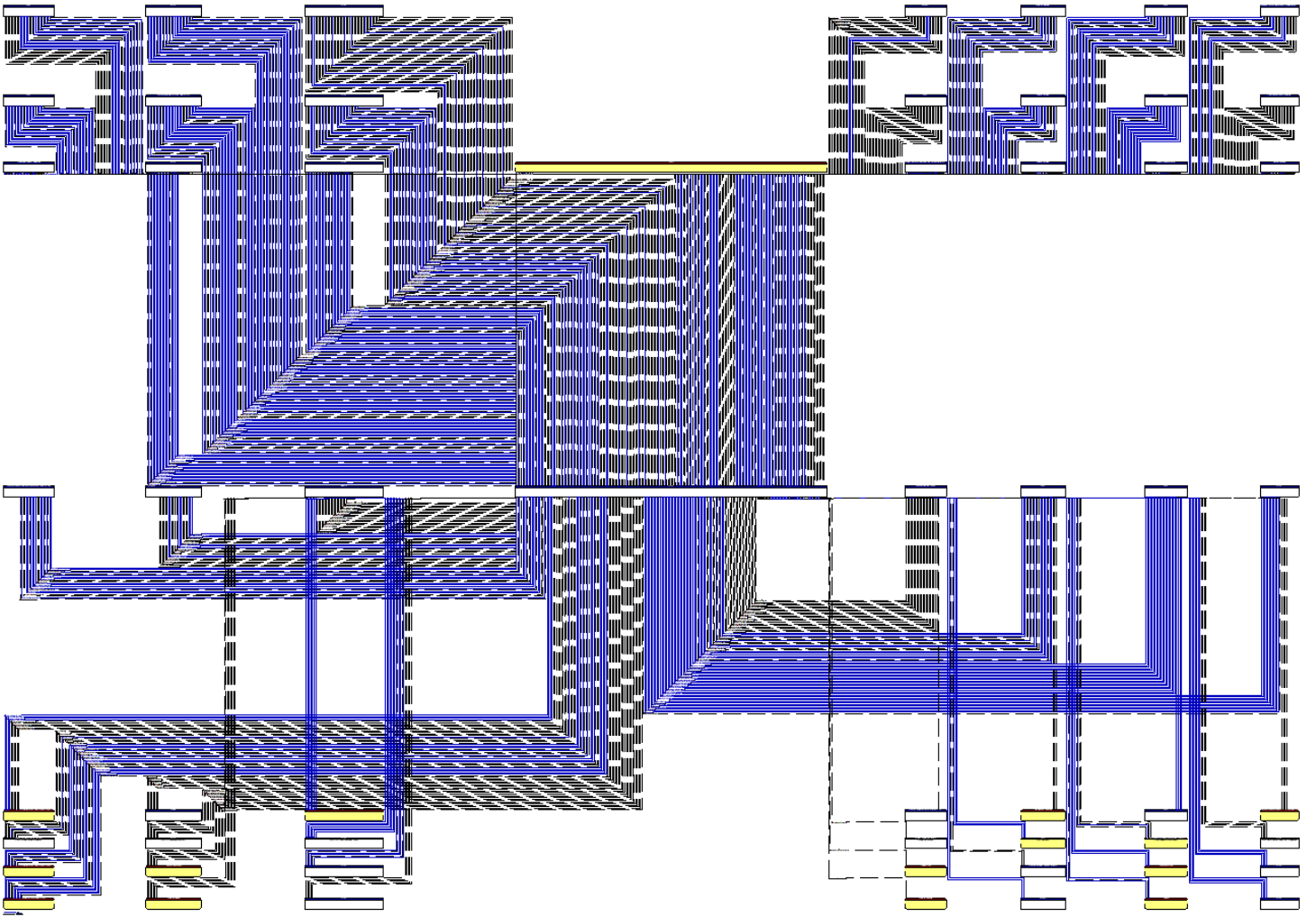

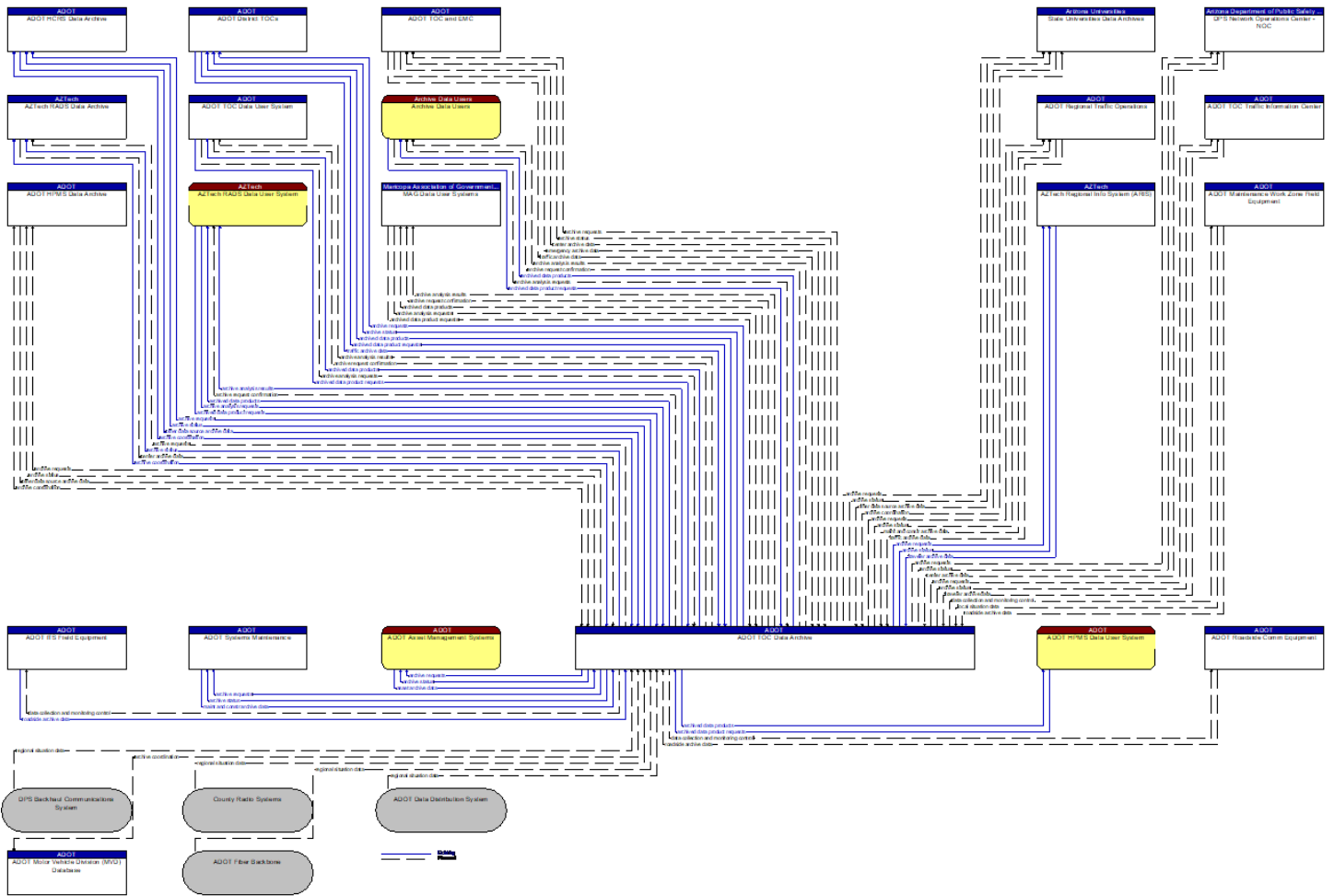

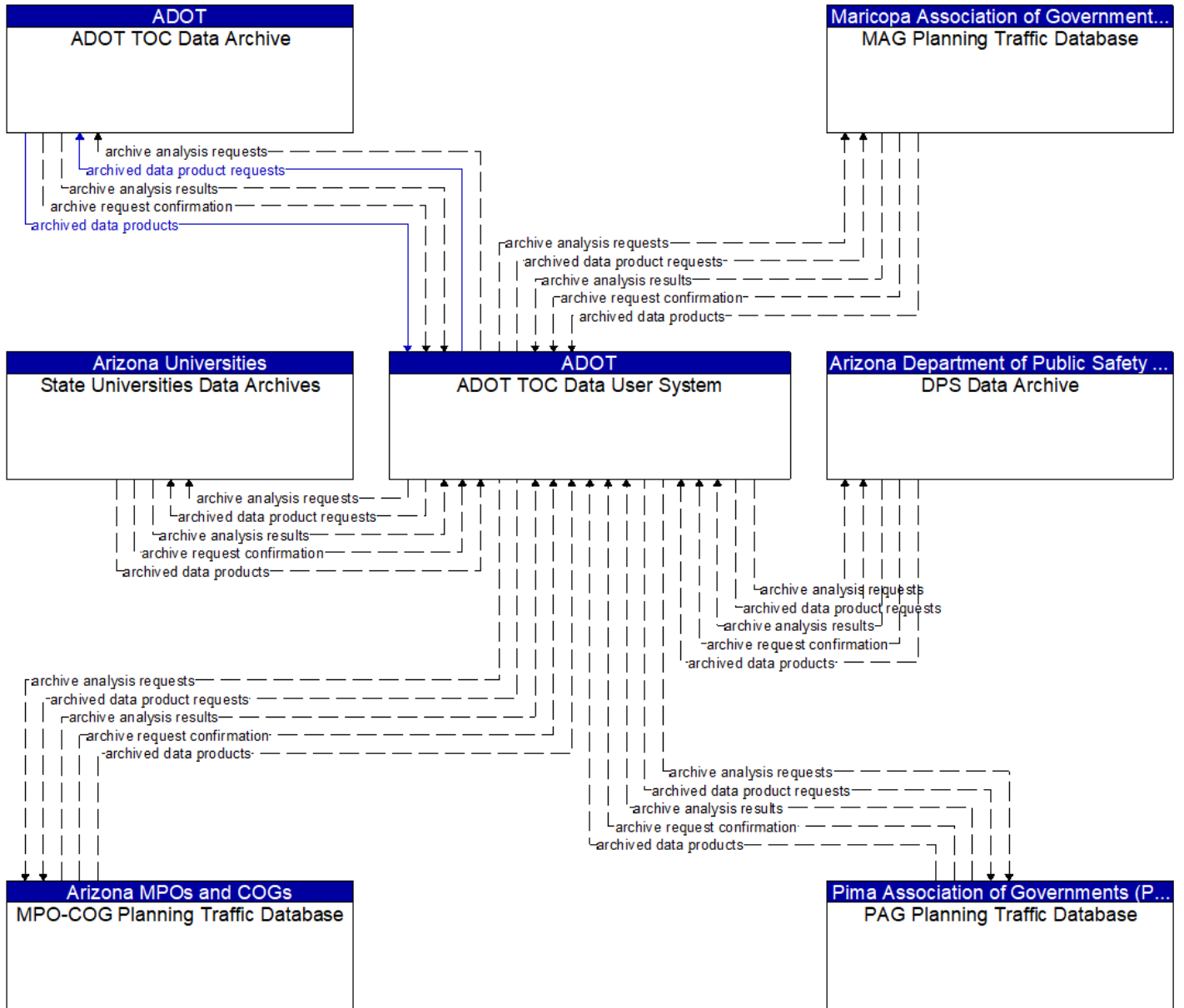

————— Existing
 - - - - - Planned

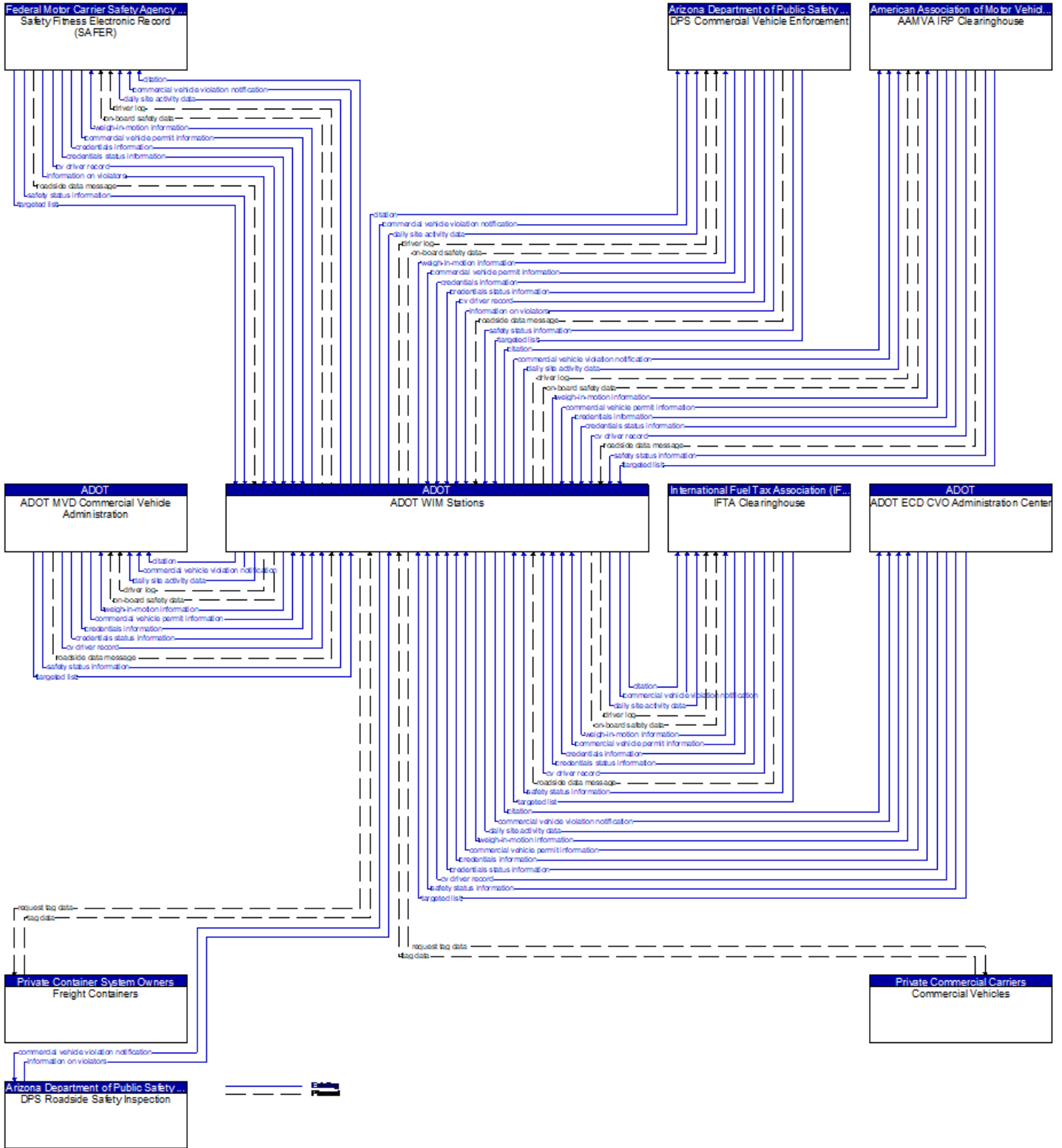

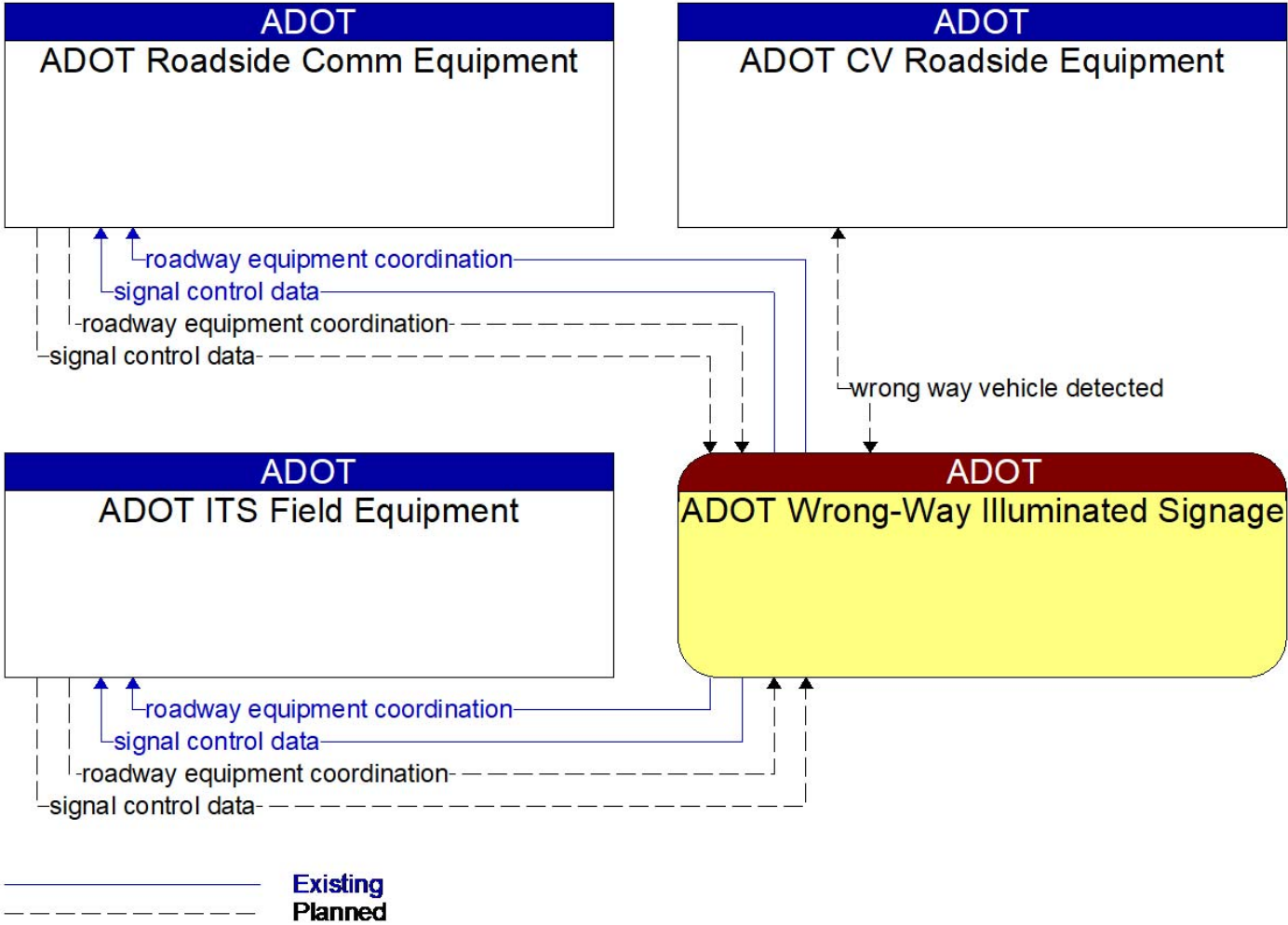

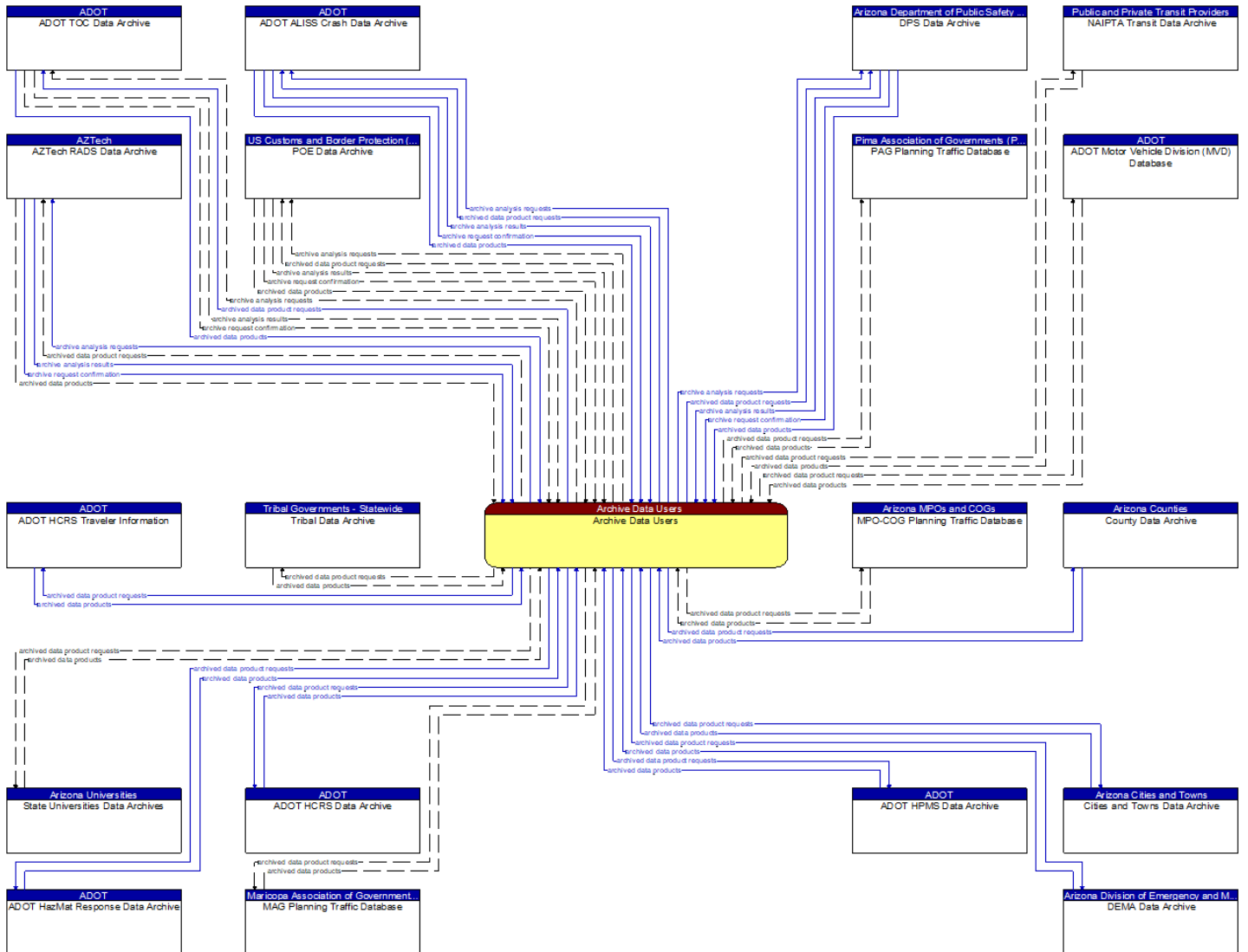

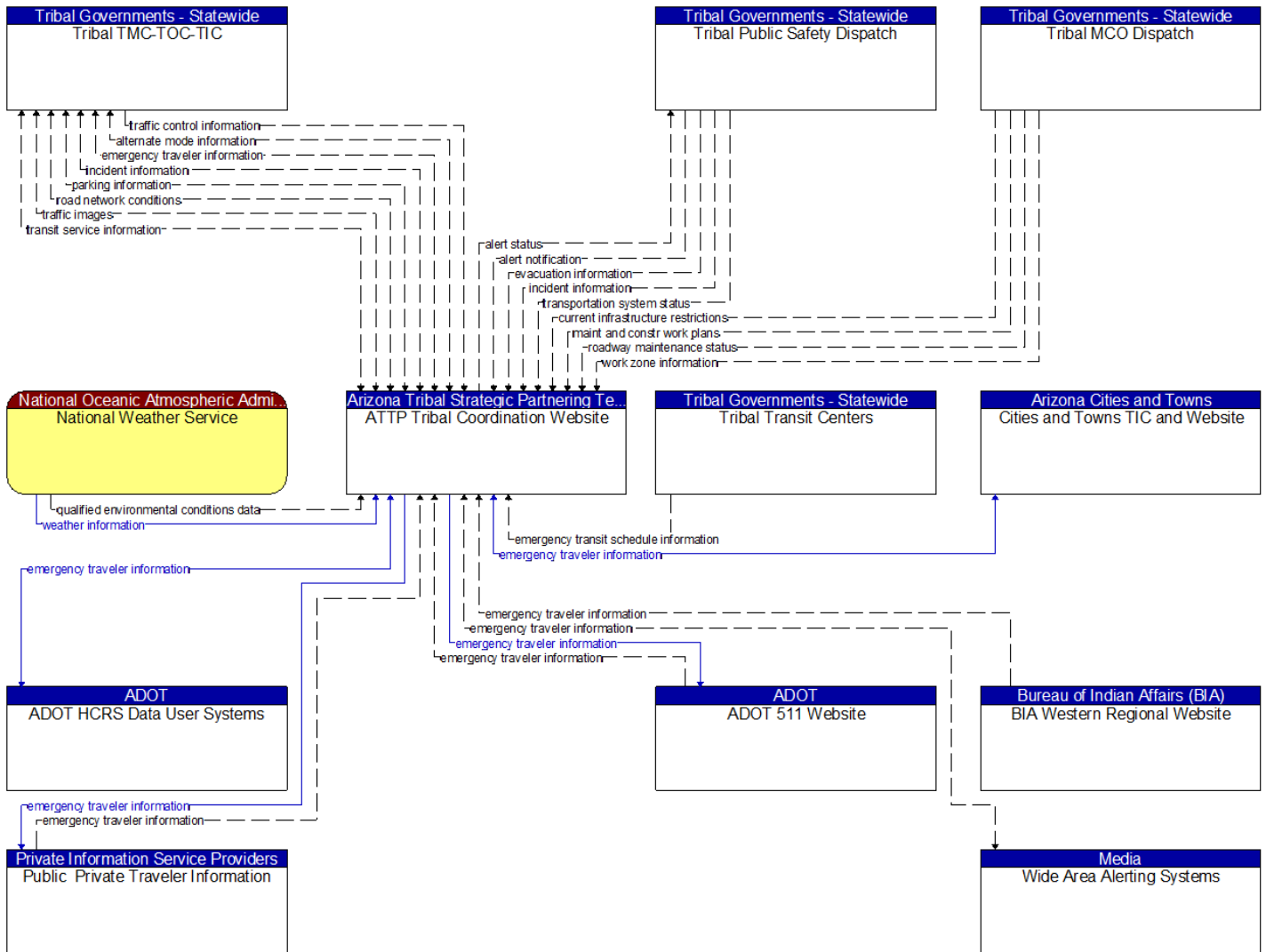

Tribal Governments - Statewide
Tribal TMC-TOC-TIC

Tribal Governments - Statewide
Tribal Public Safety Dispatch

Tribal Governments - Statewide
Tribal MCO Dispatch

National Oceanic Atmospheric Admi.
National Weather Service

Arizona Tribal Strategic Partnering Te.
ATTP Tribal Coordination Website

Tribal Governments - Statewide
Tribal Transit Centers

Arizona Cities and Towns
Cities and Towns TIC and Website

ADOT
ADOT HCRS Data User Systems

ADOT
ADOT 511 Website

Bureau of Indian Affairs (BIA)
BIA Western Regional Website

Private Information Service Providers
Public Private Traveler Information

Media
Wide Area Alerting Systems

- traffic control information
- alternate mode information
- emergency traveler information
- incident information
- parking information
- road network conditions
- traffic images
- transit service information

- alert status
- alert notification
- evacuation information
- incident information
- transportation system status
- current infrastructure restrictions
- maint and constr work plans
- roadway maintenance status
- work zone information

- qualified environmental conditions data
- weather information

- emergency traveler information

- emergency transit schedule information
- emergency traveler information

- emergency traveler information
- emergency traveler information
- emergency traveler information
- emergency traveler information

- emergency traveler information
- emergency traveler information

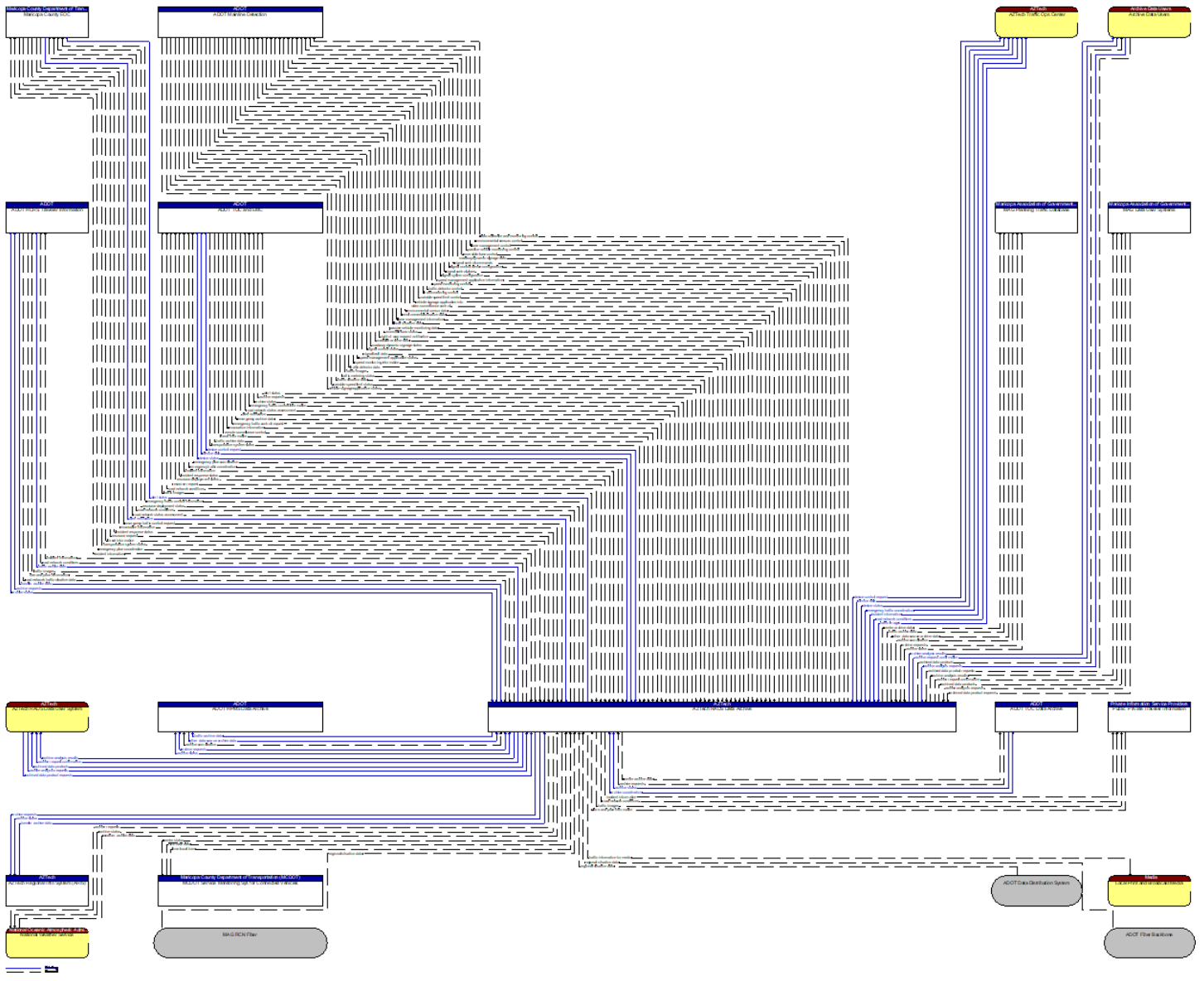

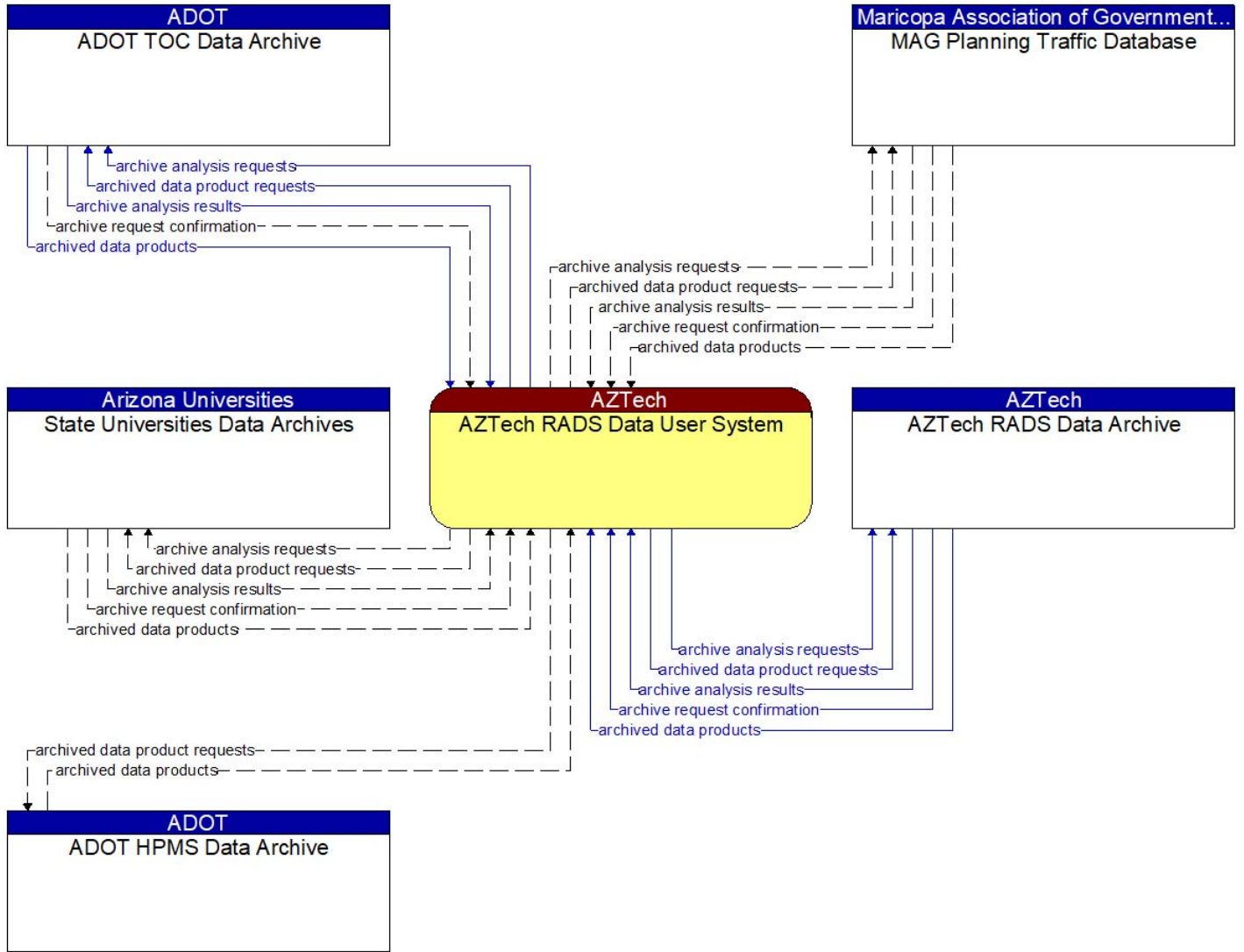

_____ Existing
 - - - - - Planned

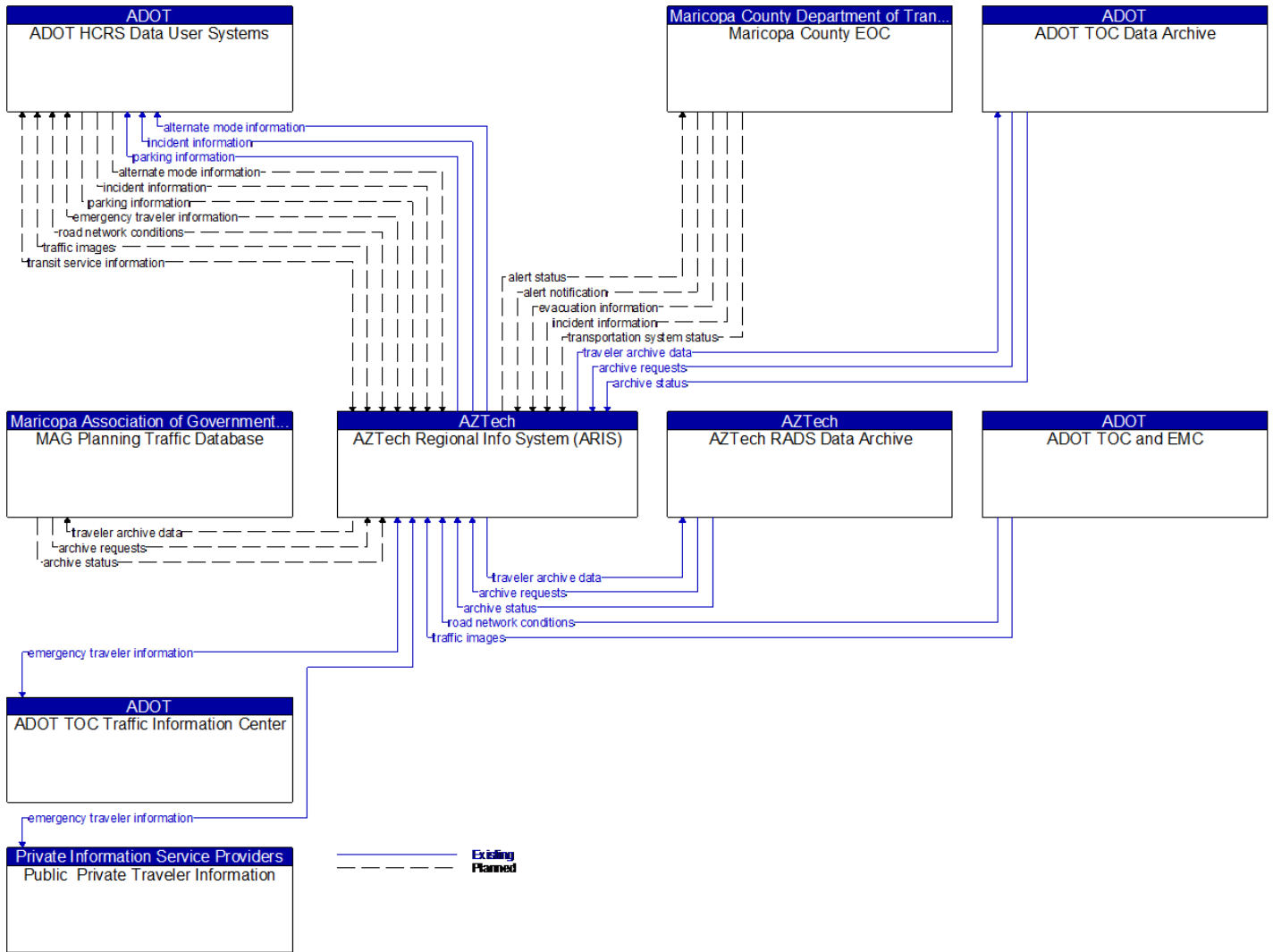

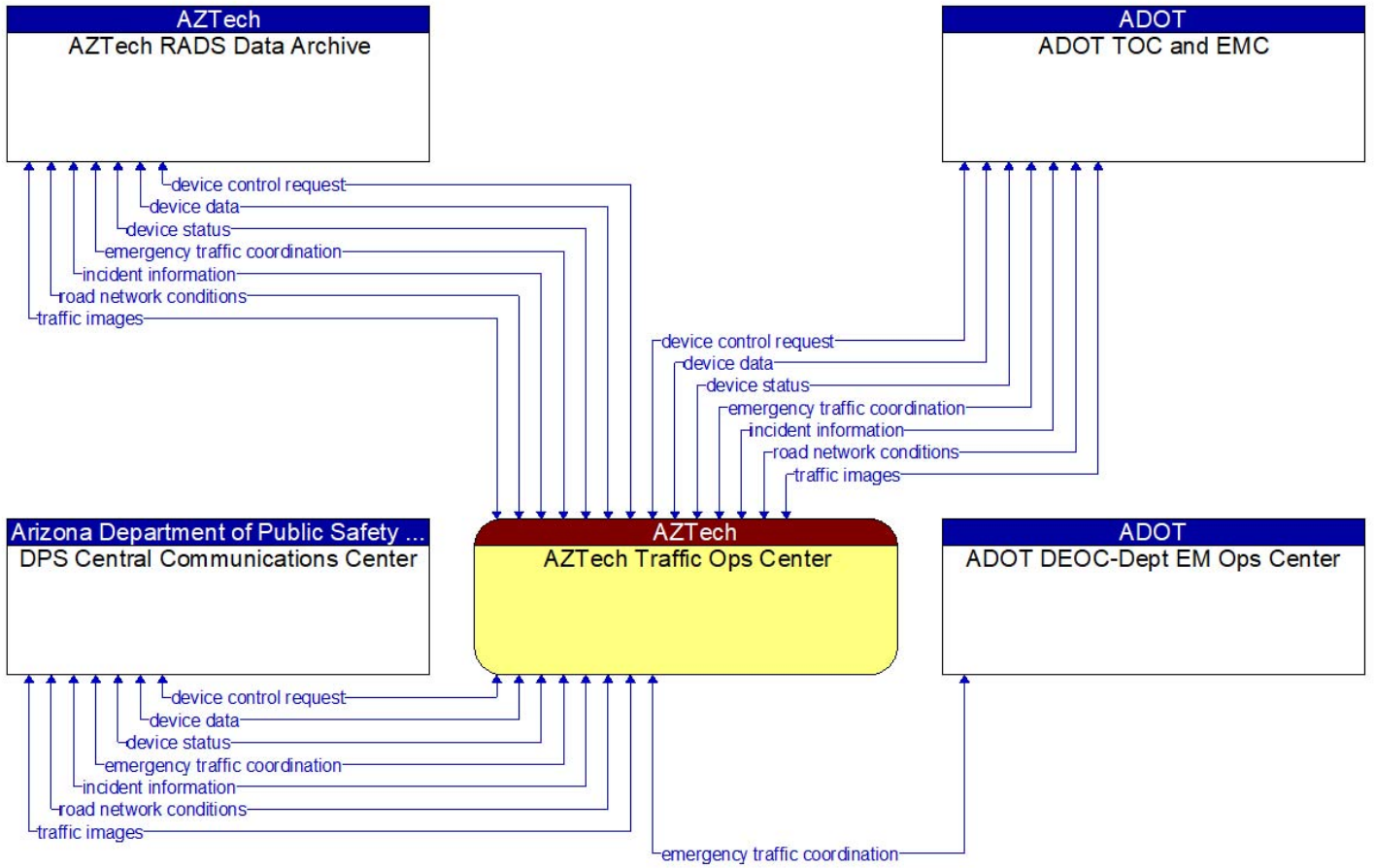

Existing

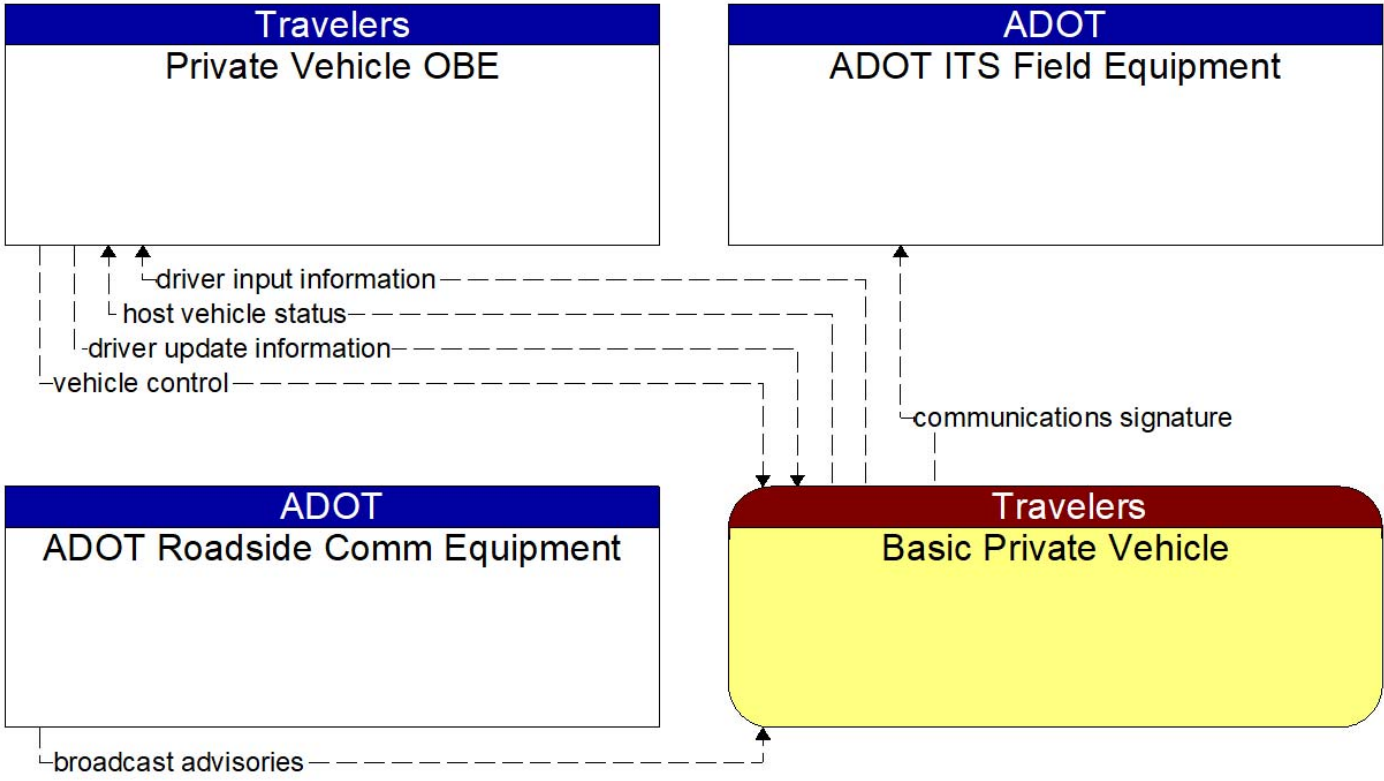

----- **Planned**

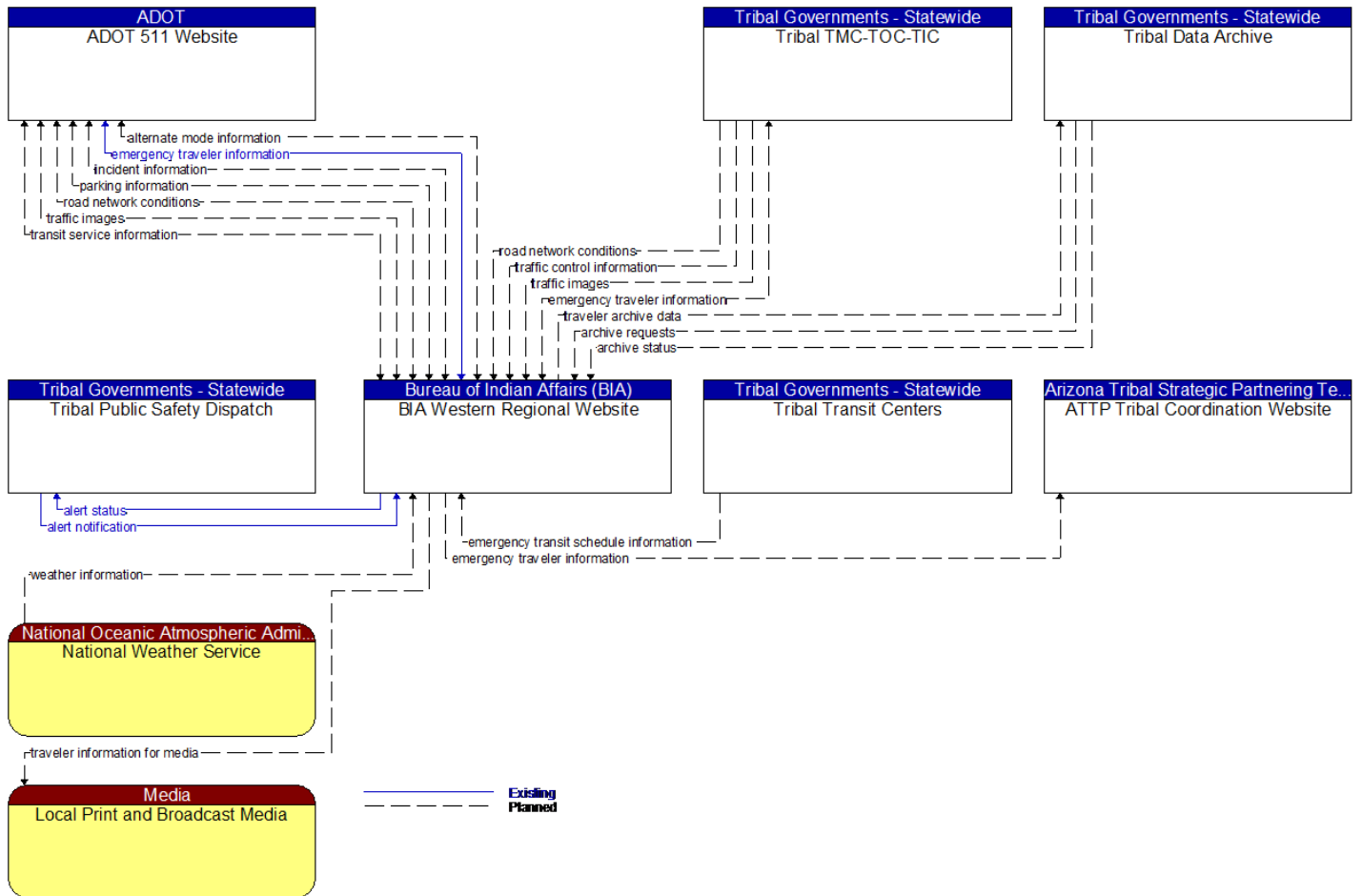

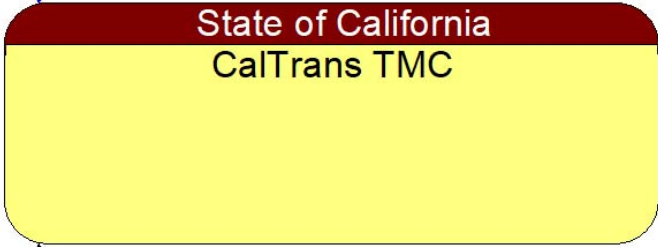
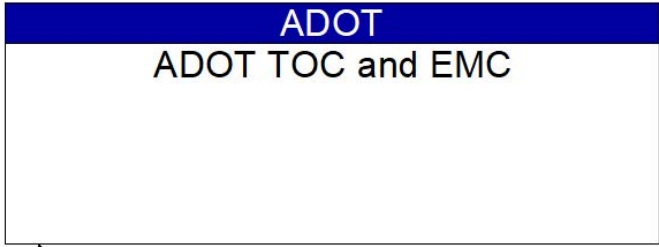
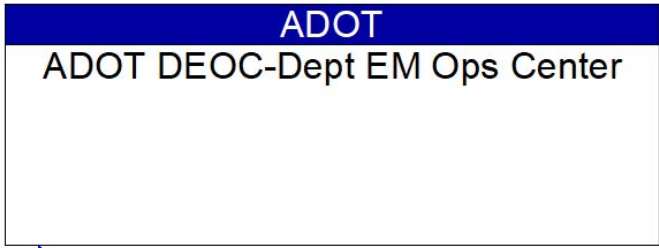

— emergency traffic coordination —

- - - emergency traffic coordination - - -

— Existing
- - - Planned

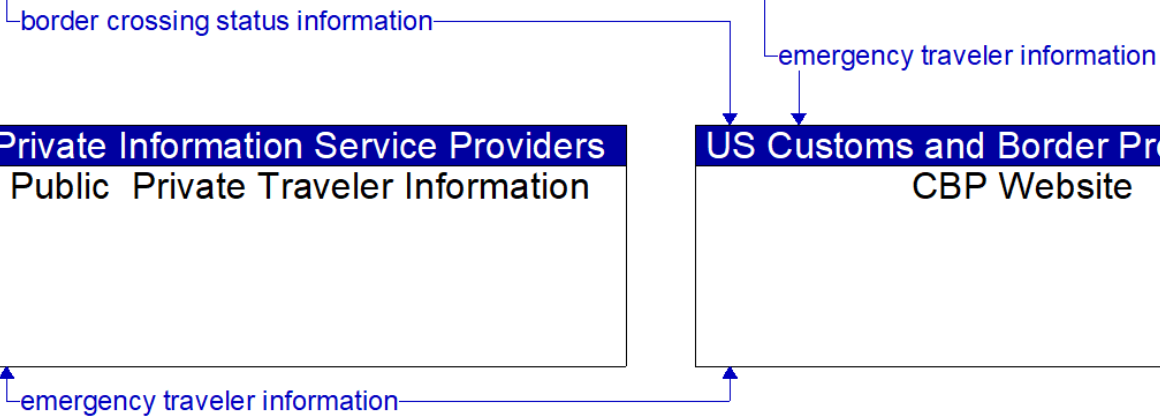
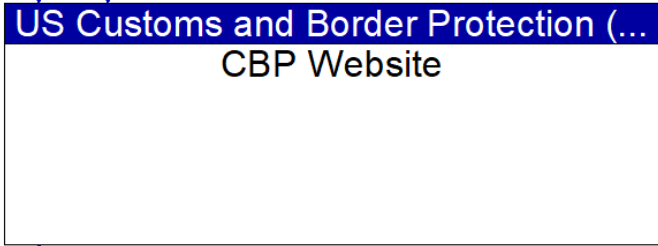
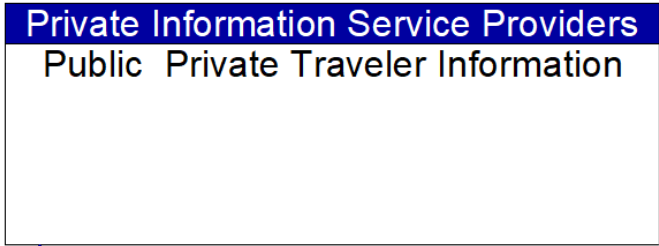
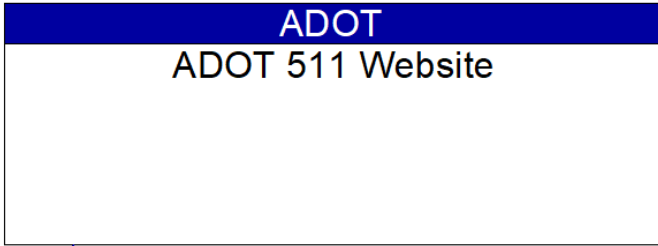
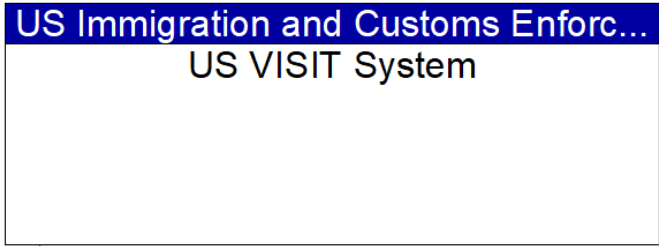

Existing

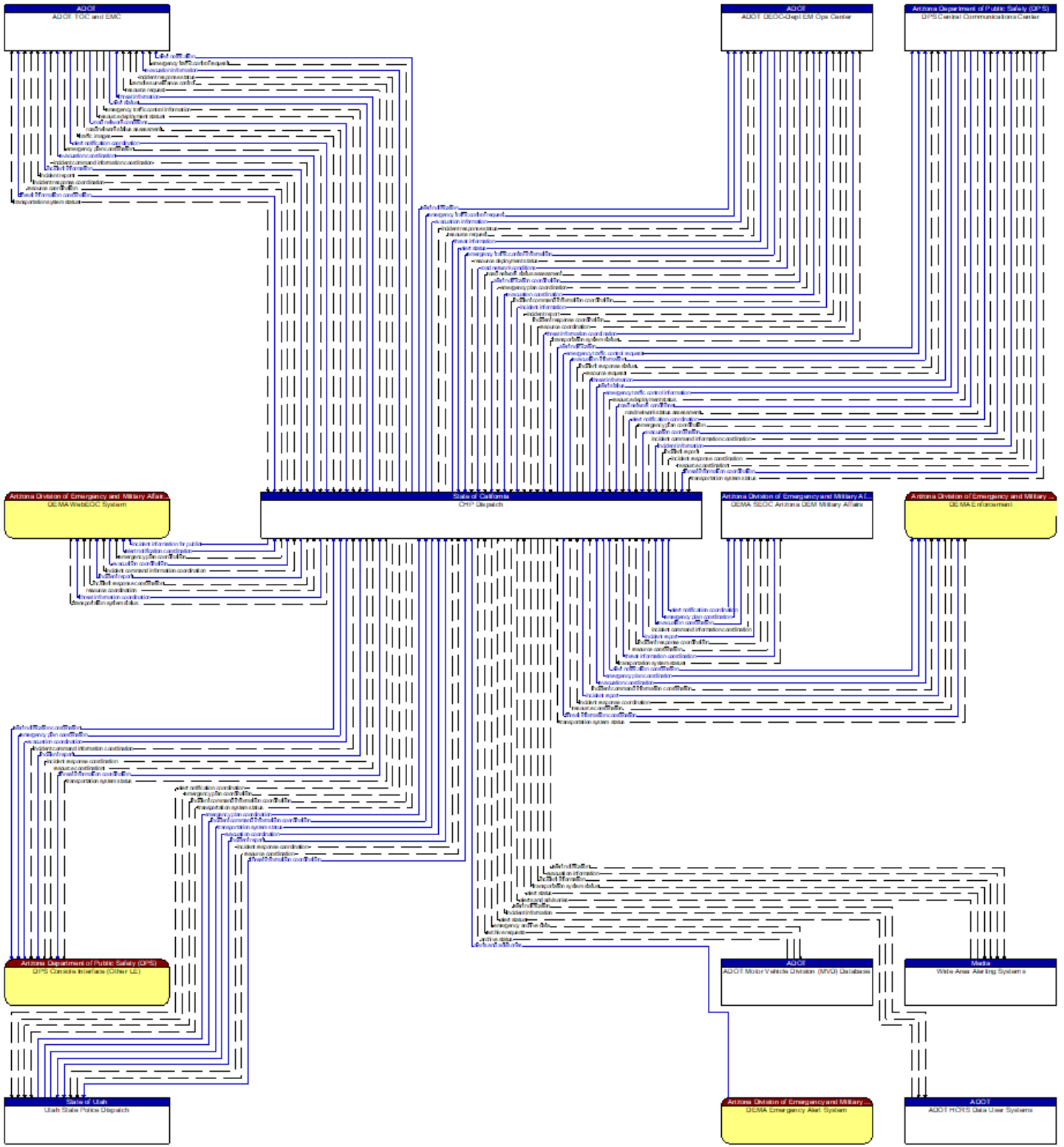

Legend
 — Data

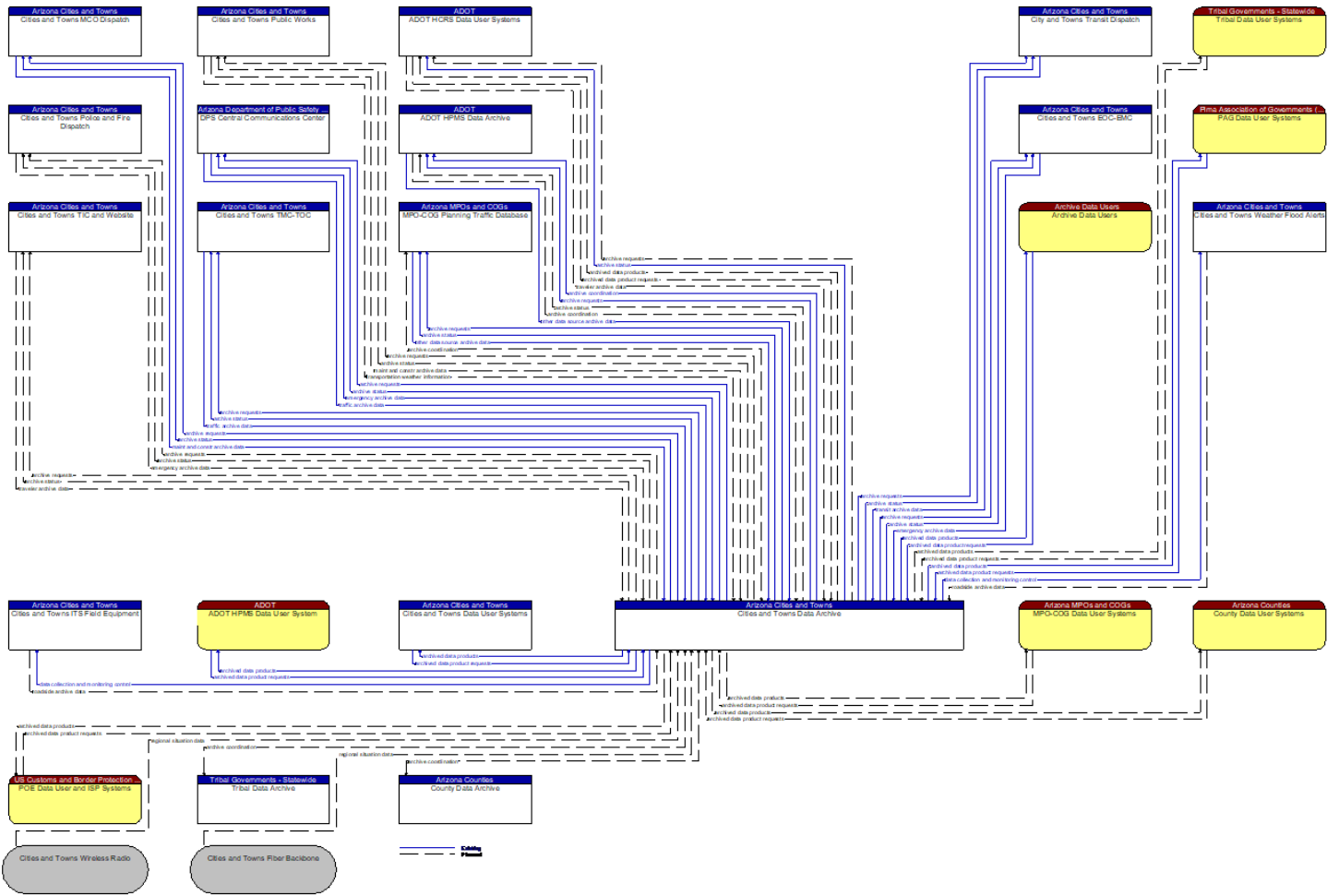

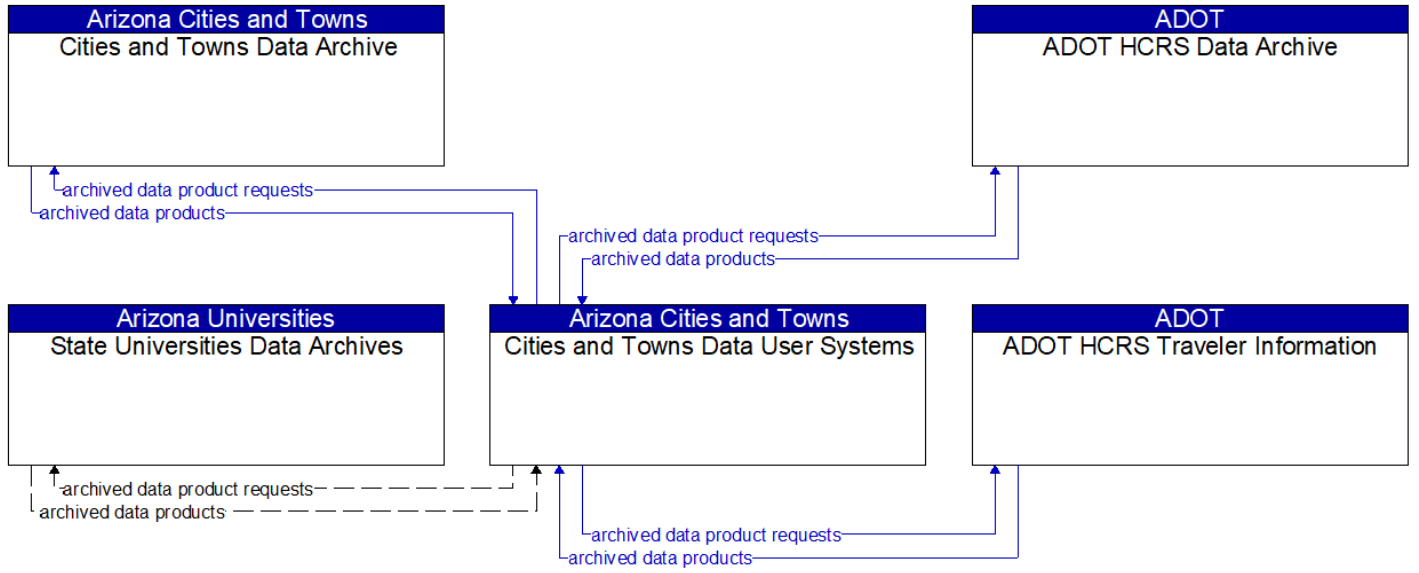

————— Existing
 - - - - - Planned

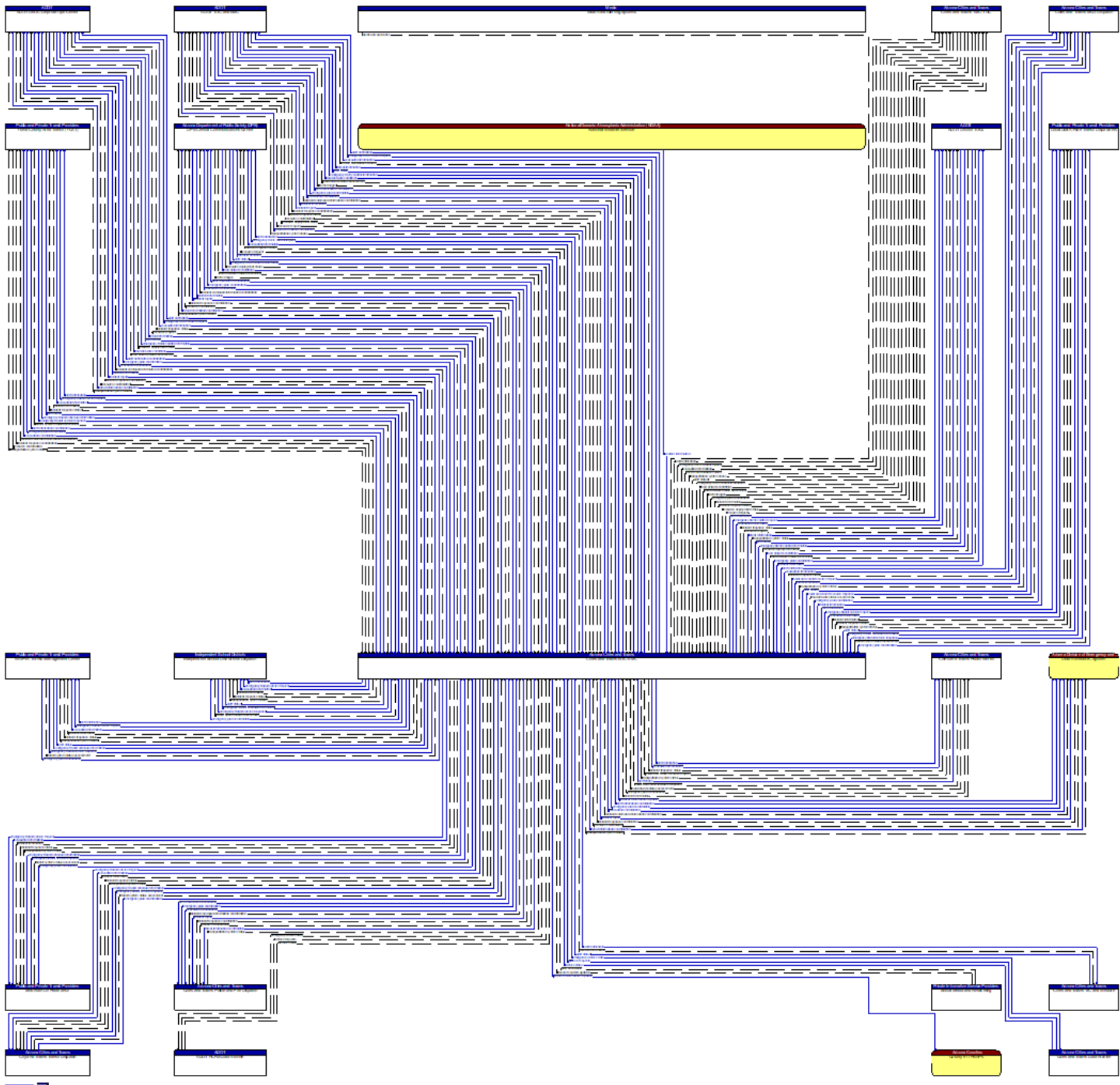

Cities and Towns Fiber Backbone

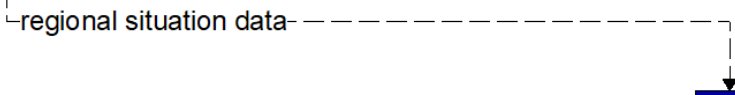

Arizona Cities and Towns
Cities and Towns Data Archive

----- **Planned**

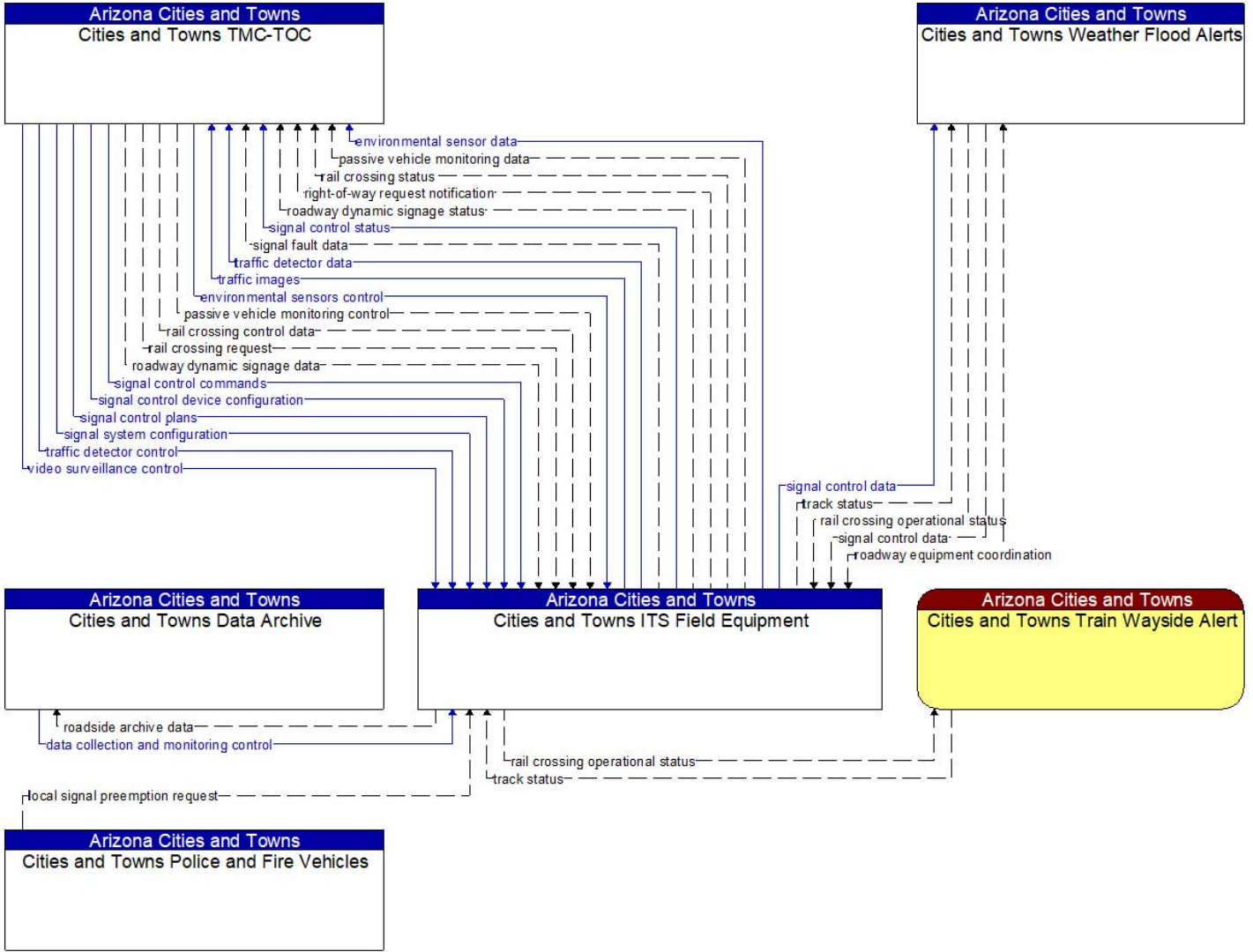

————— Existing
 - - - - - Planned

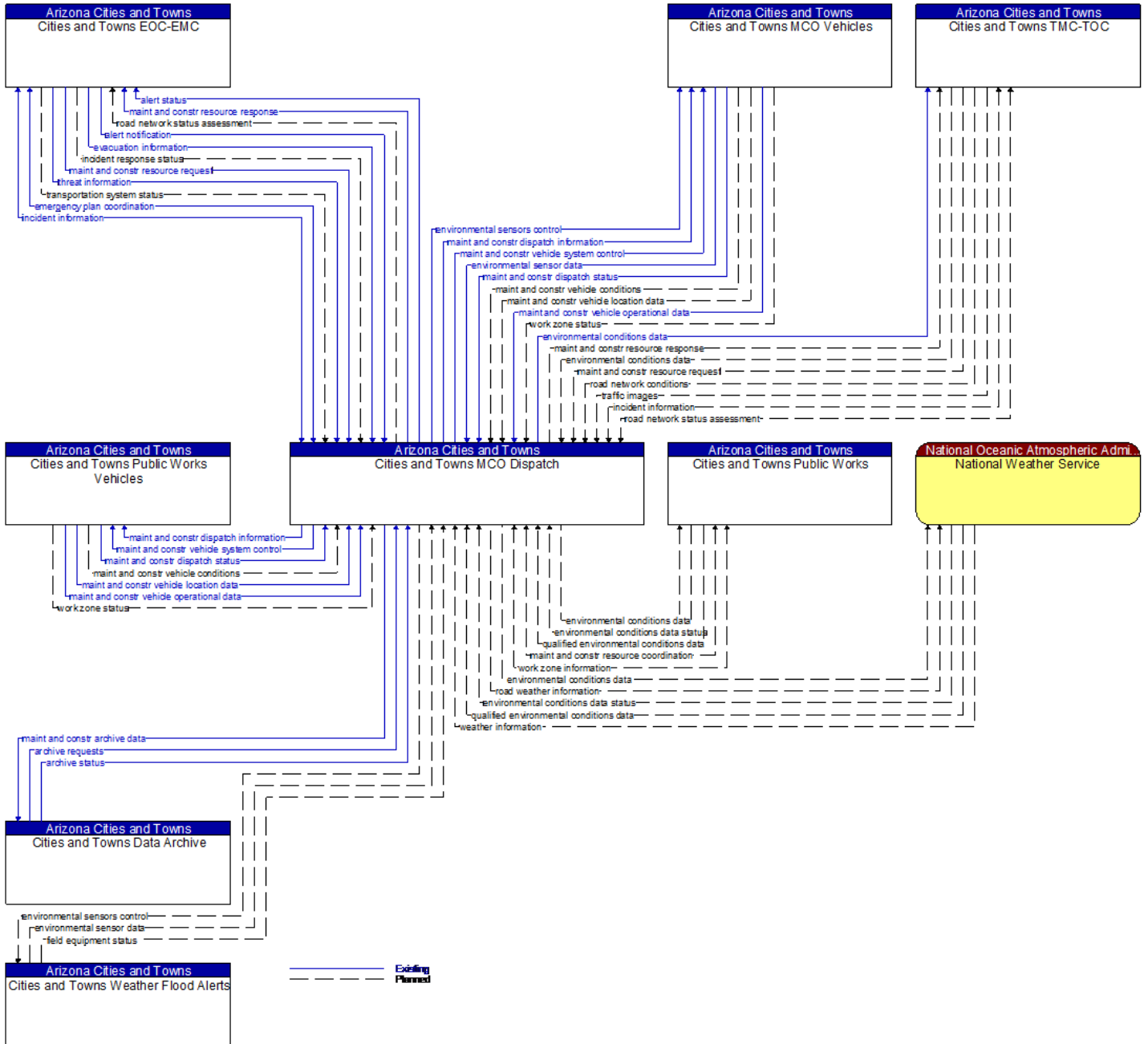

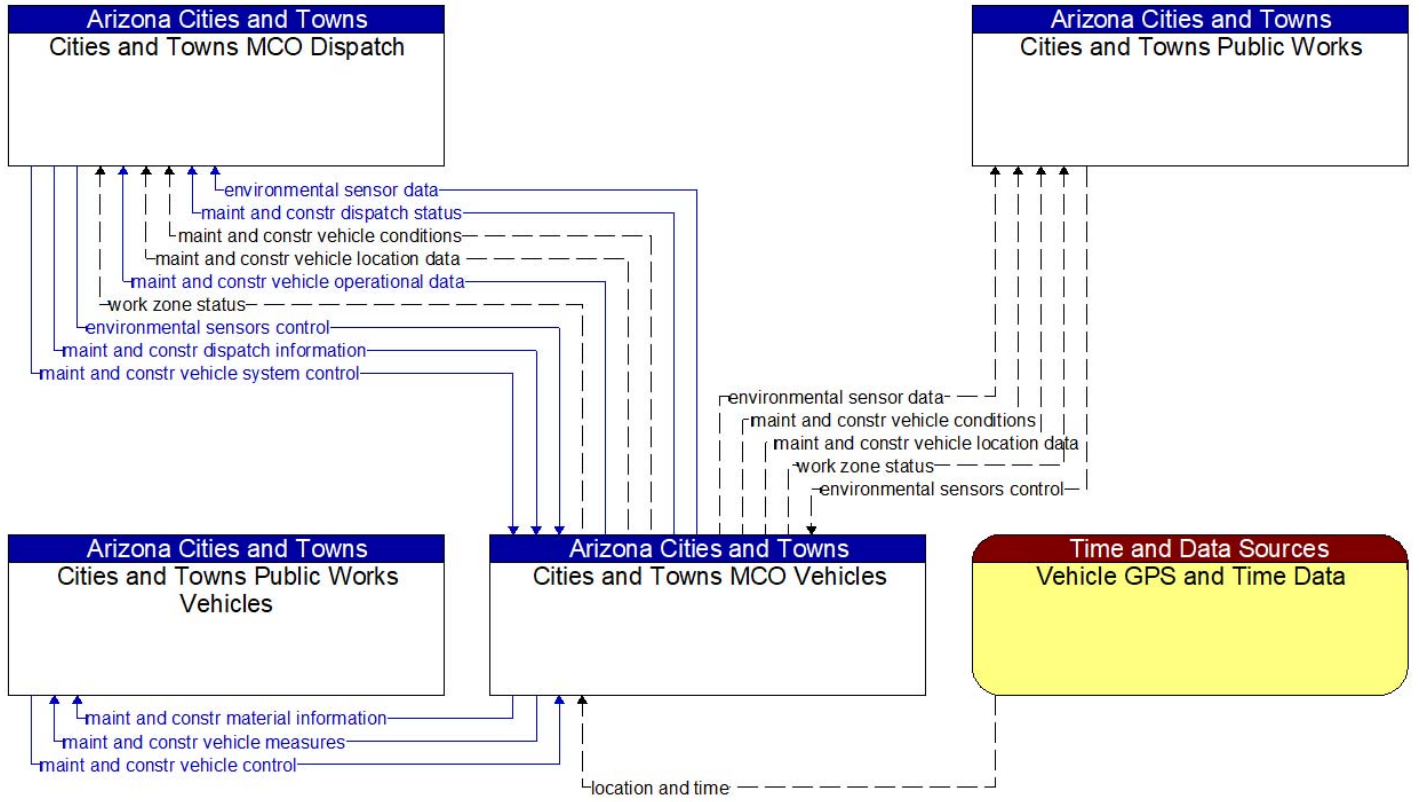

_____ Existing
 - - - - - Planned

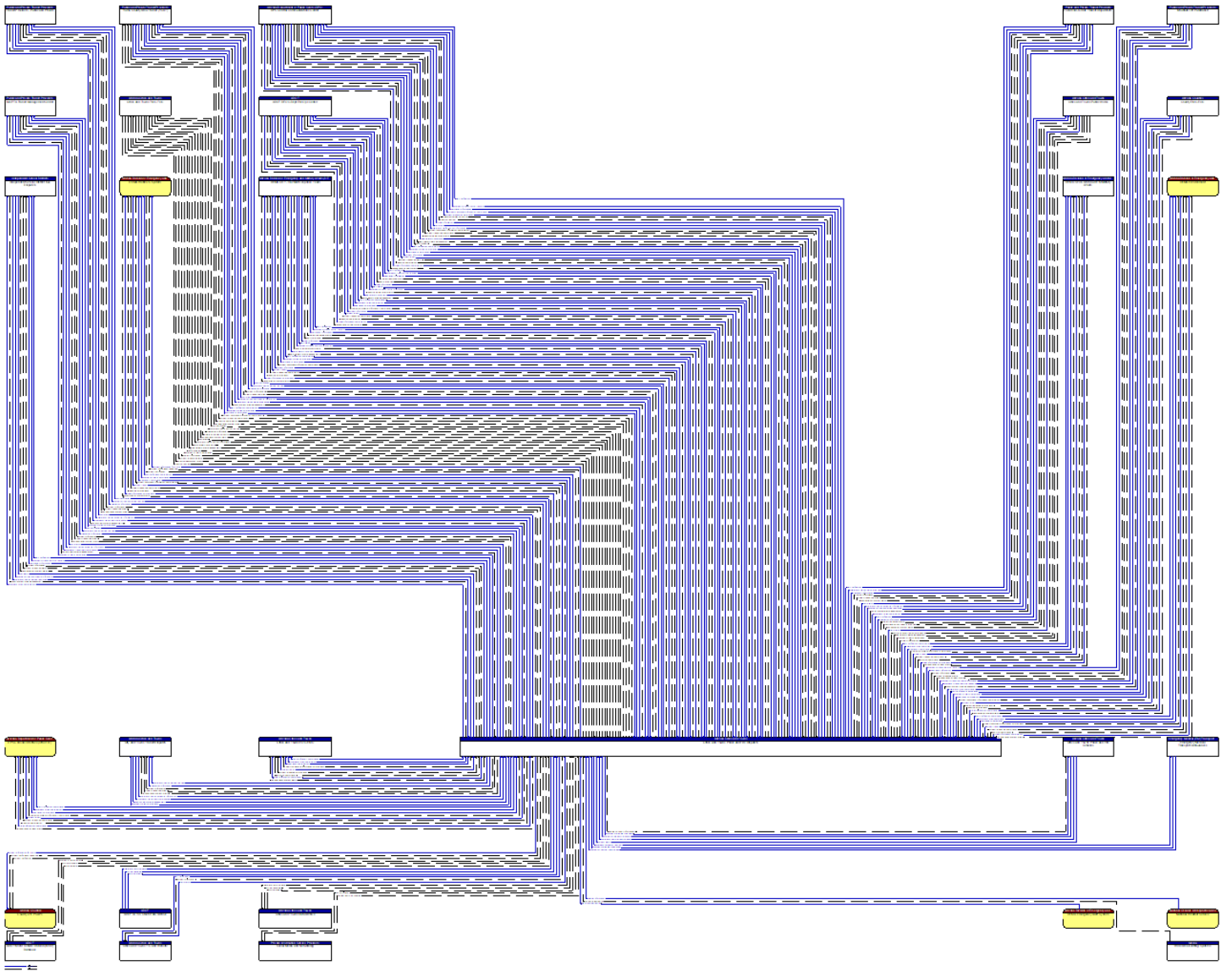

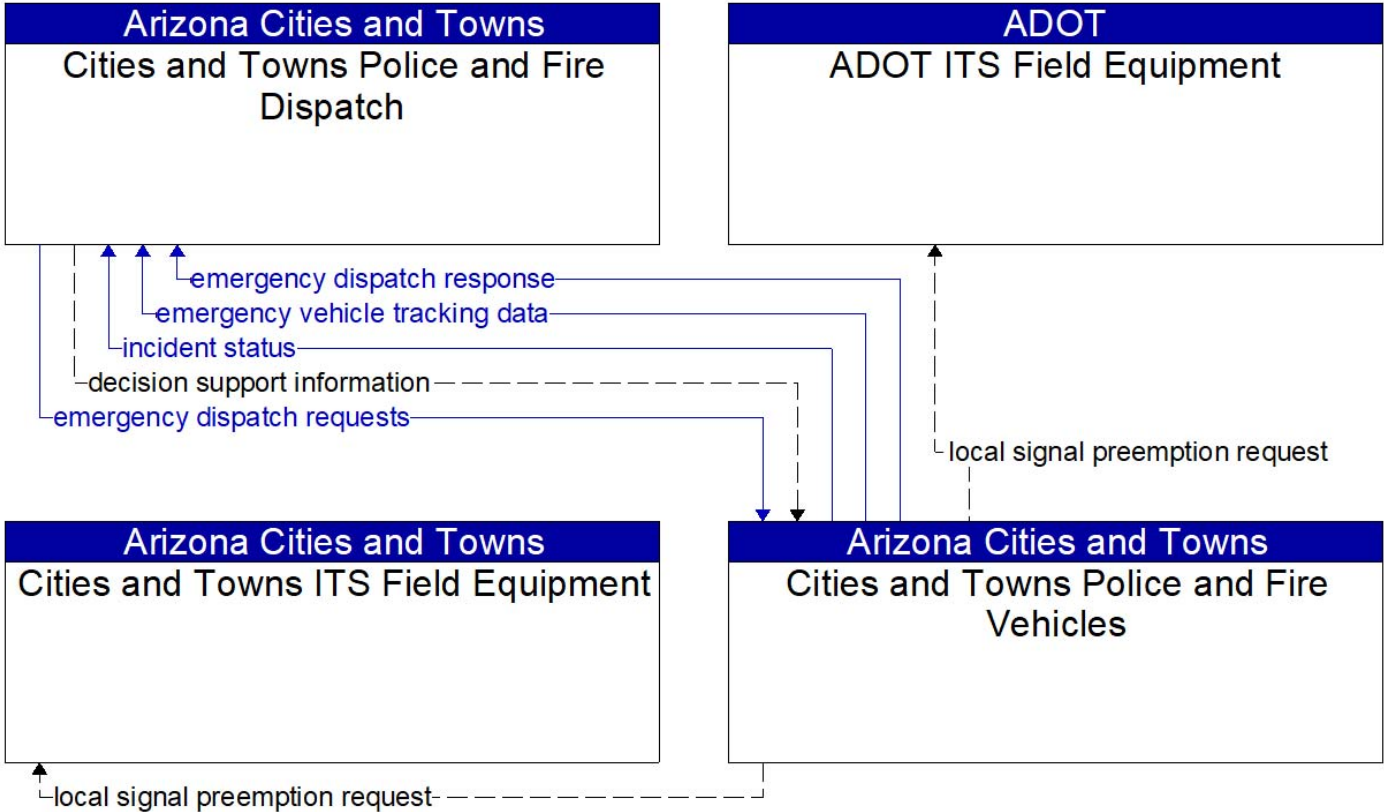

_____ Existing
 - - - - - Planned

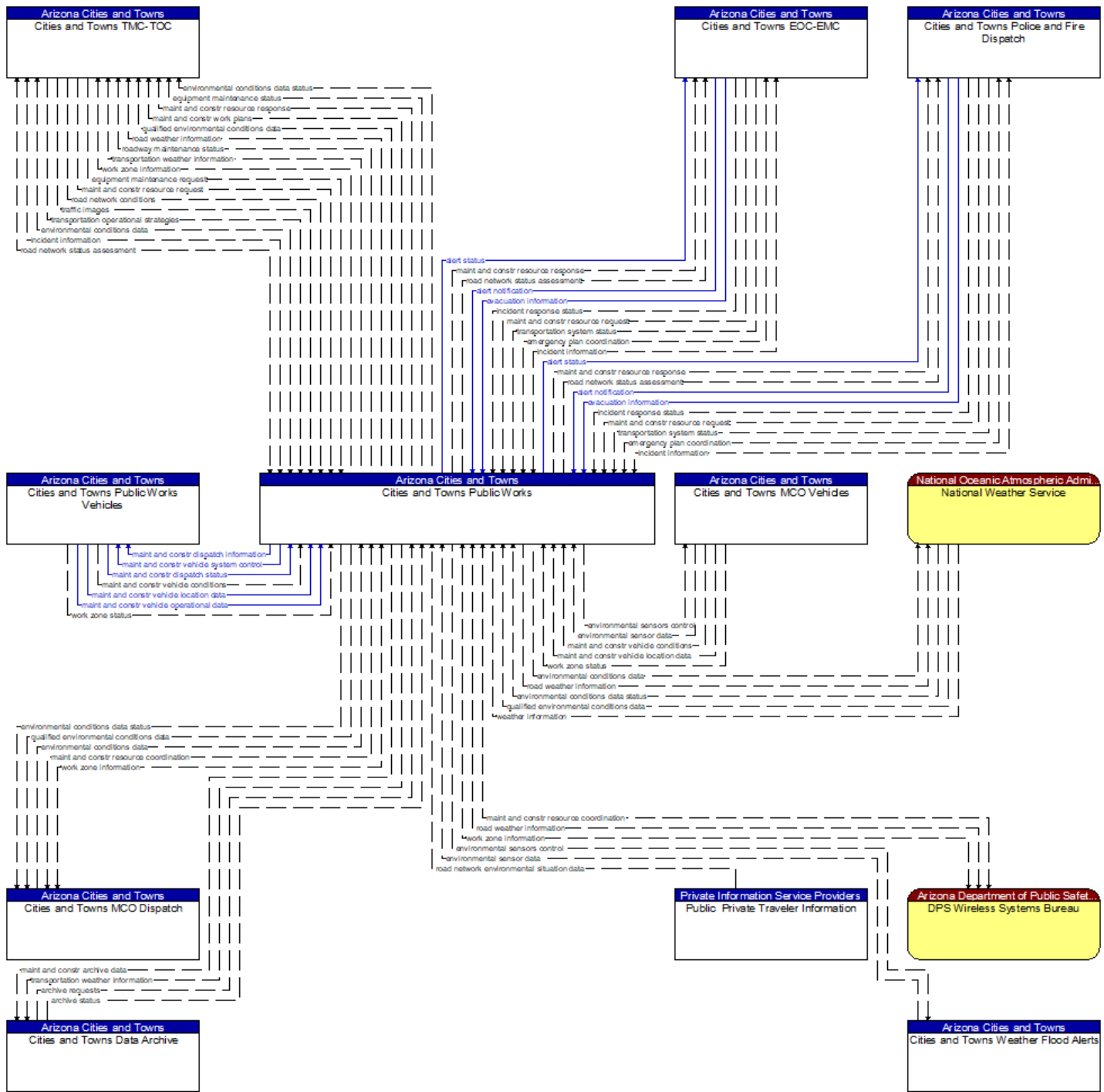

— Existing
 - - - Planned

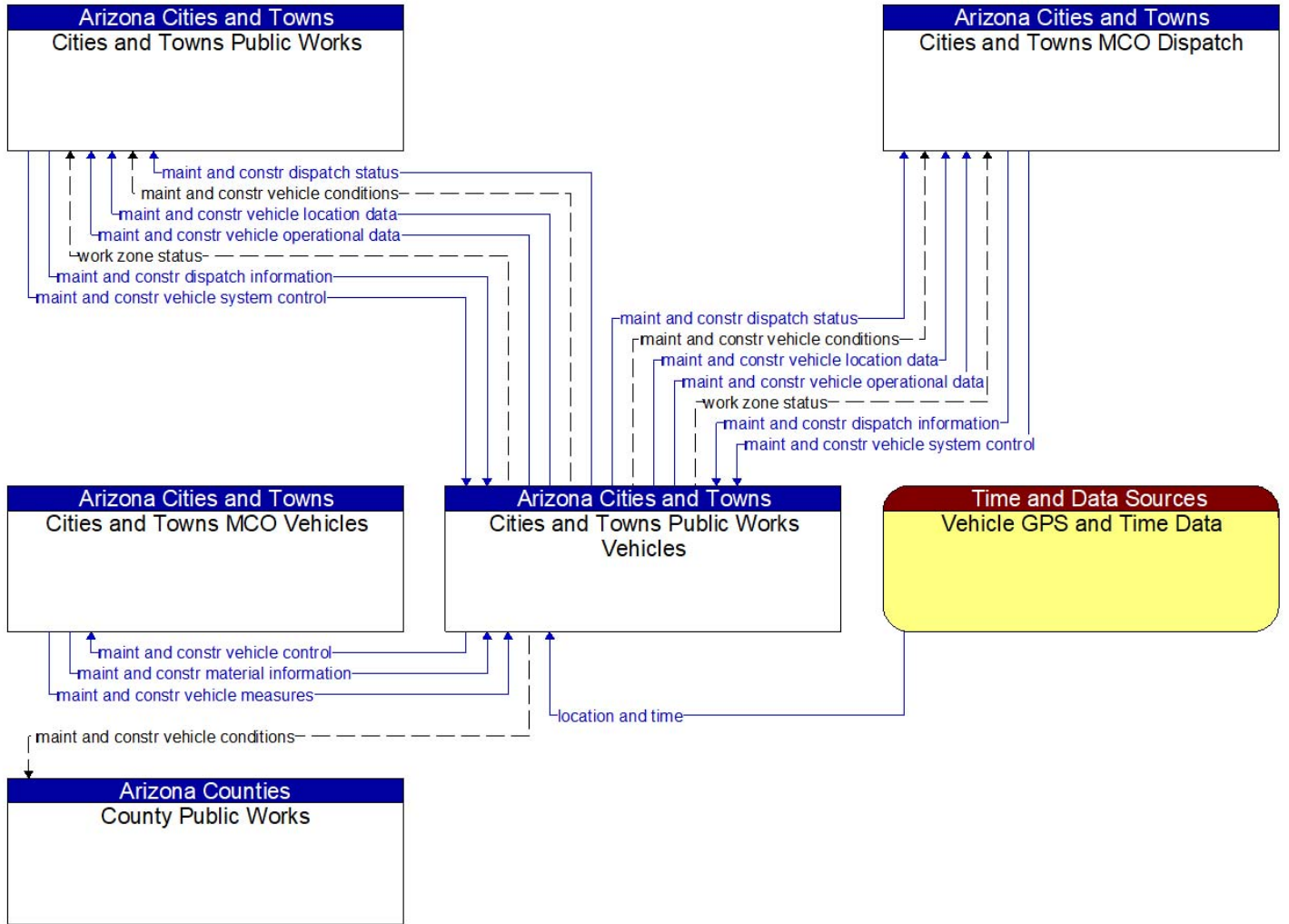

_____ Existing
 - - - - - Planned

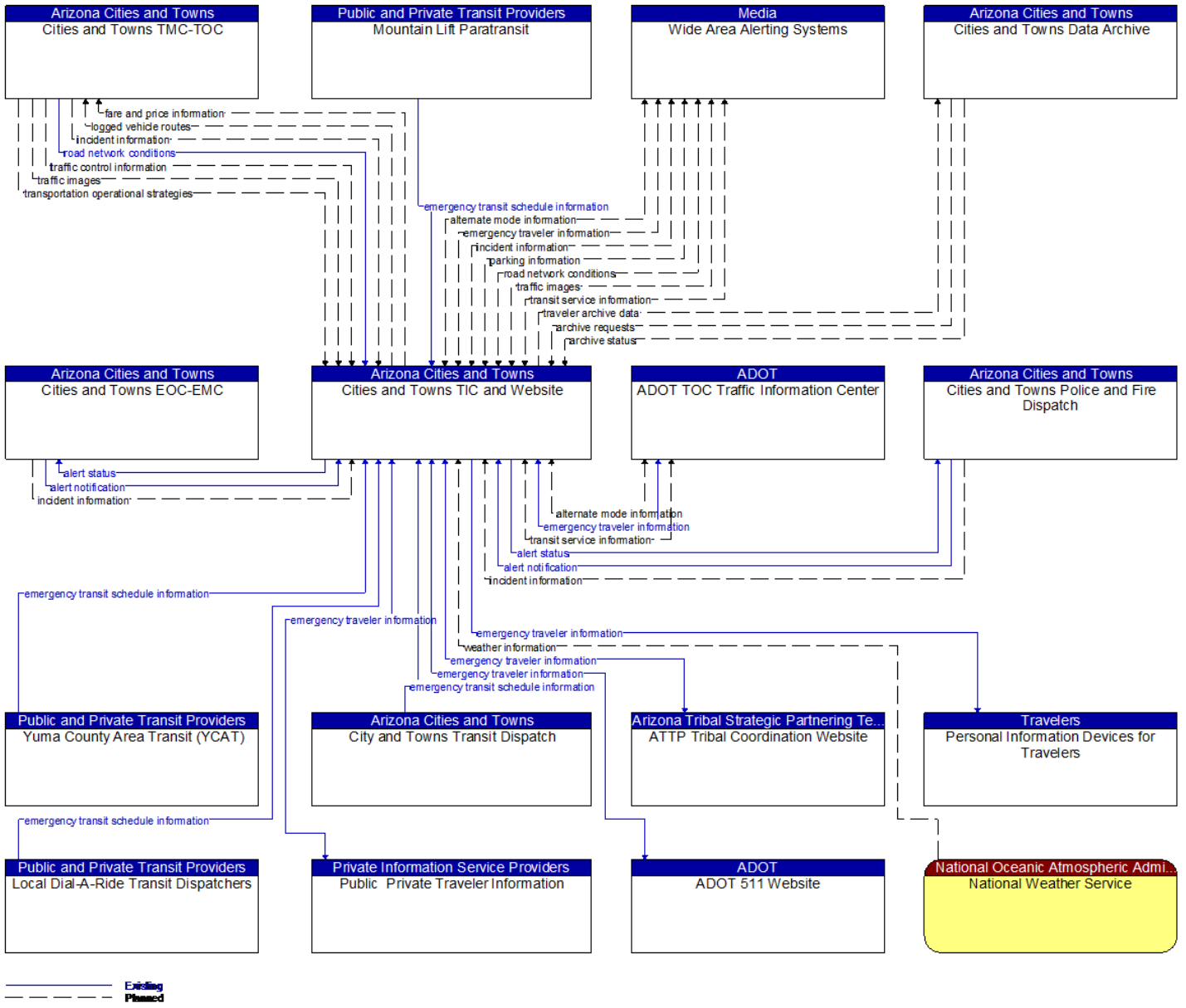

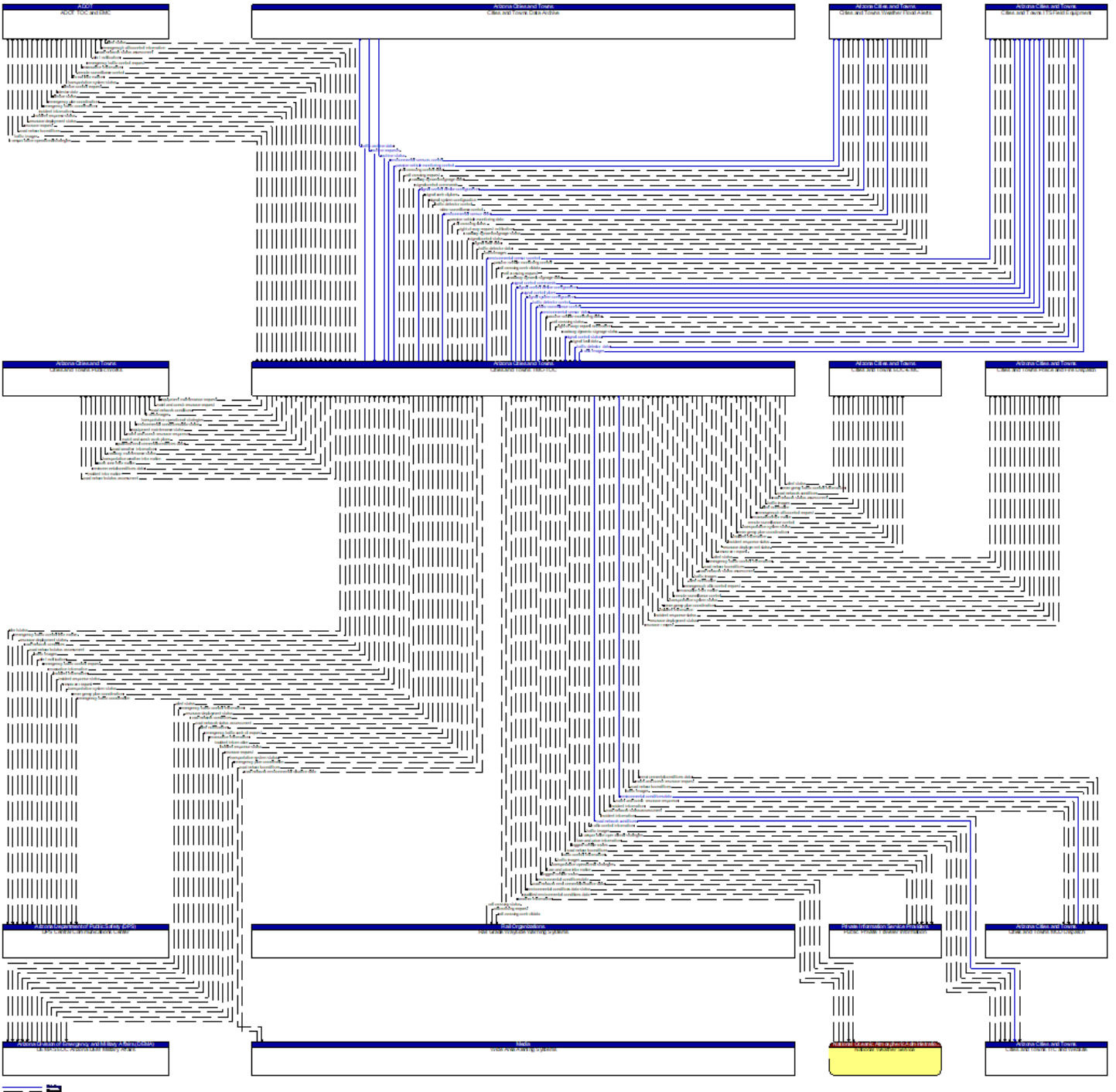

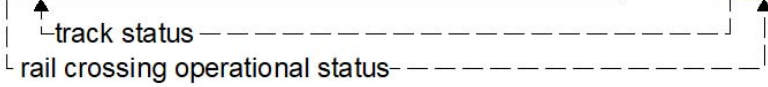
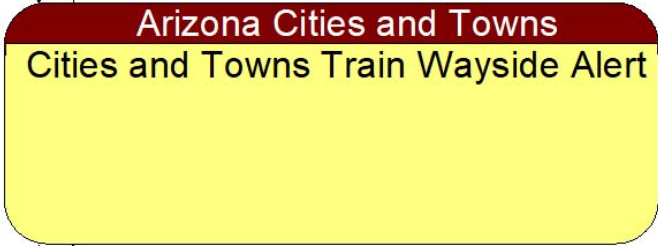
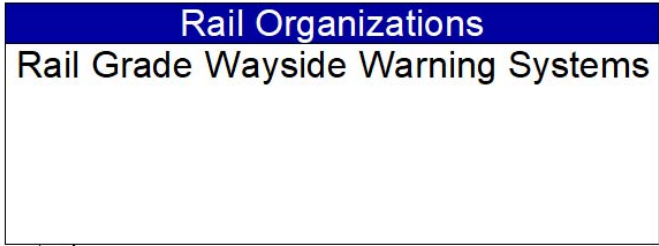
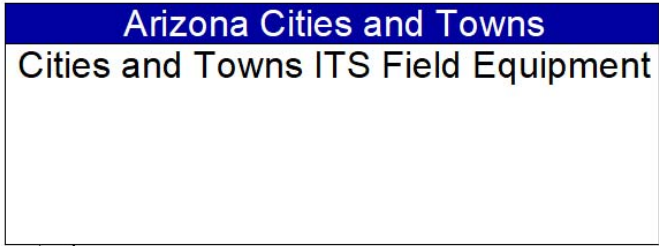

----- **Planned**

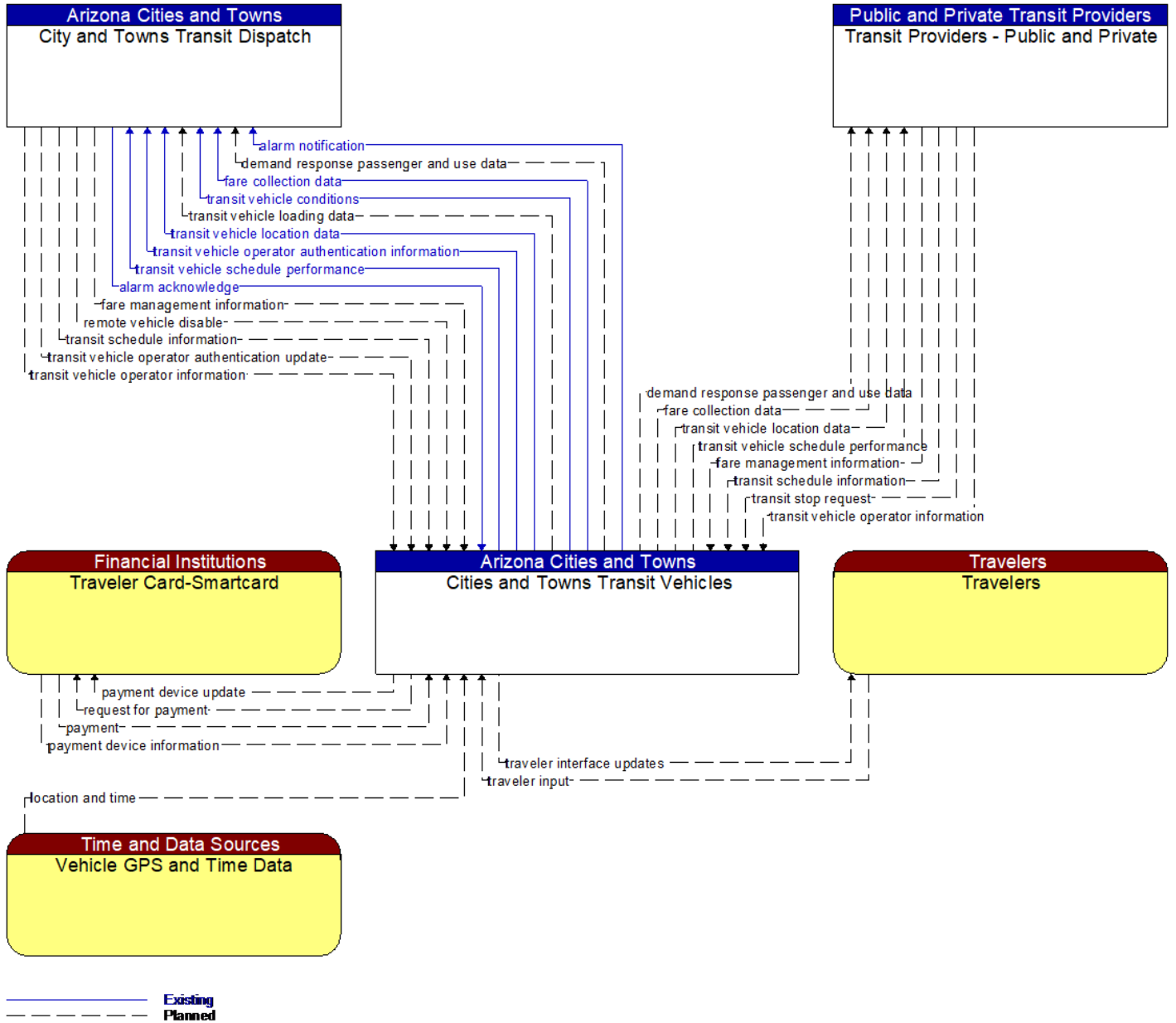

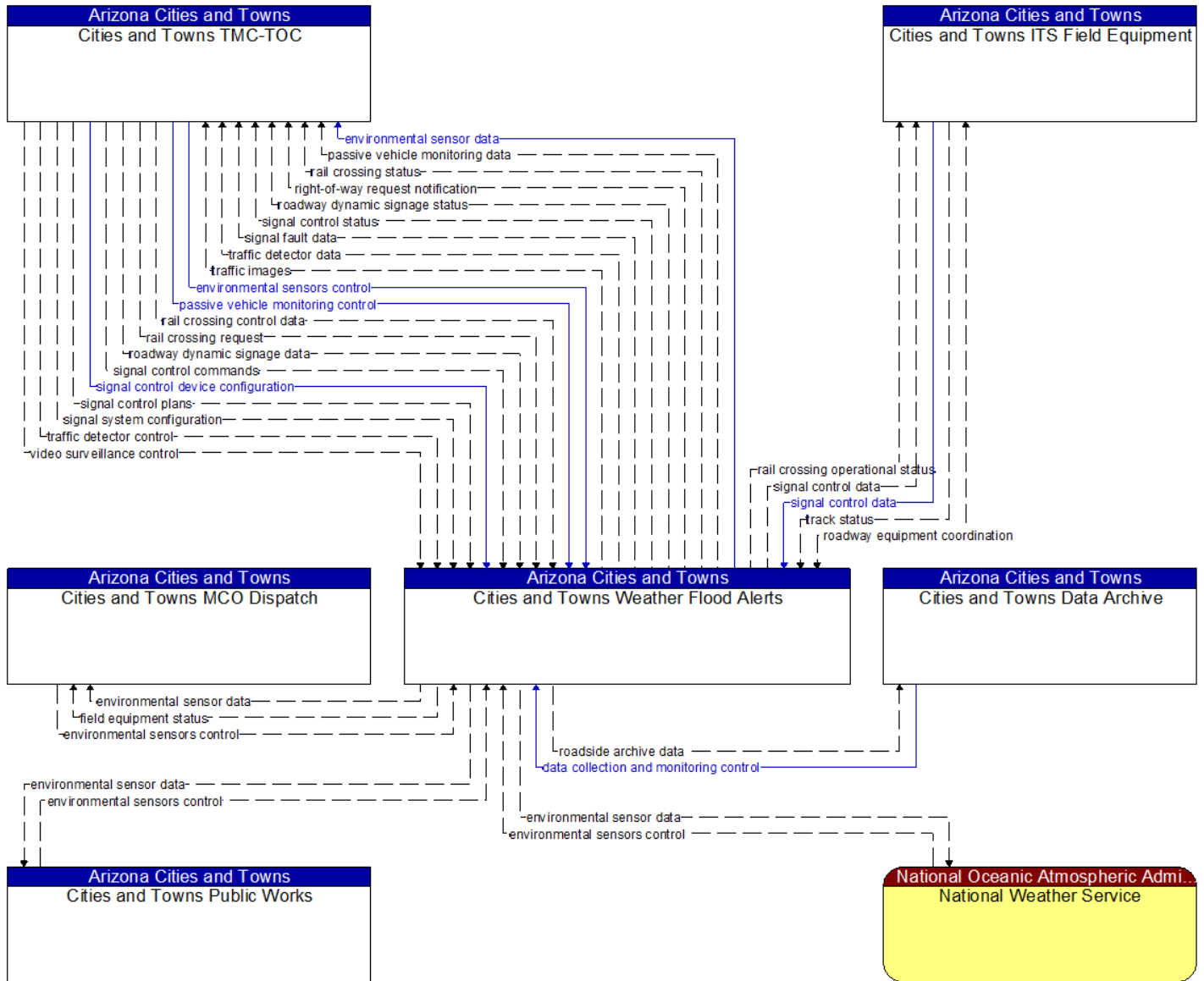

— Existing
- - - Planned

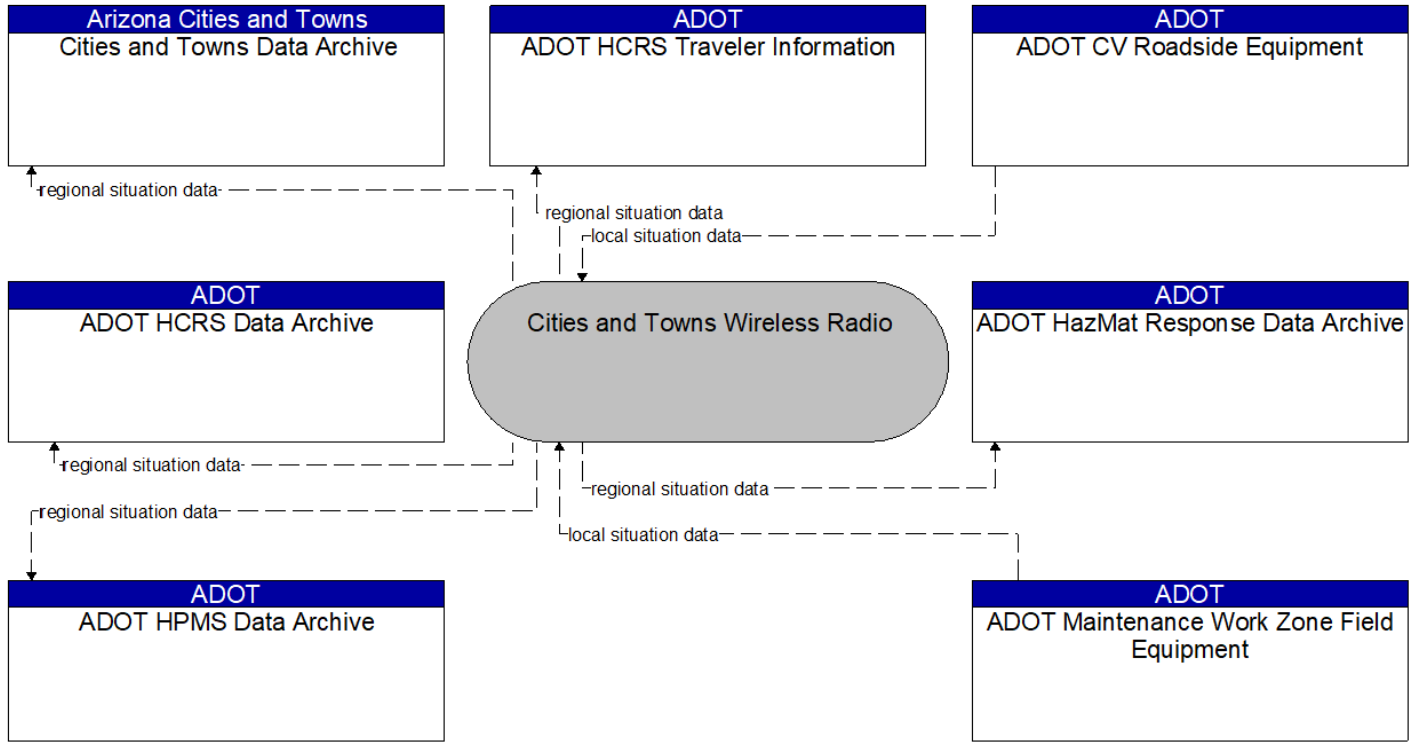

----- Planned

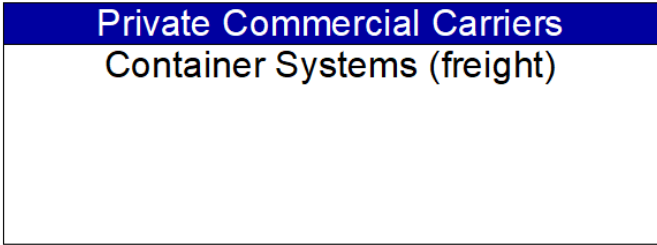
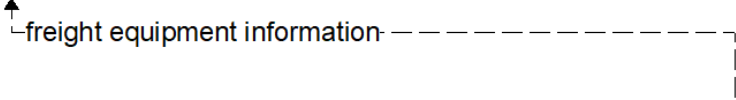
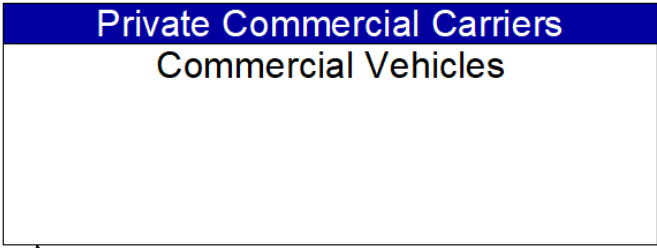

----- **Planned**

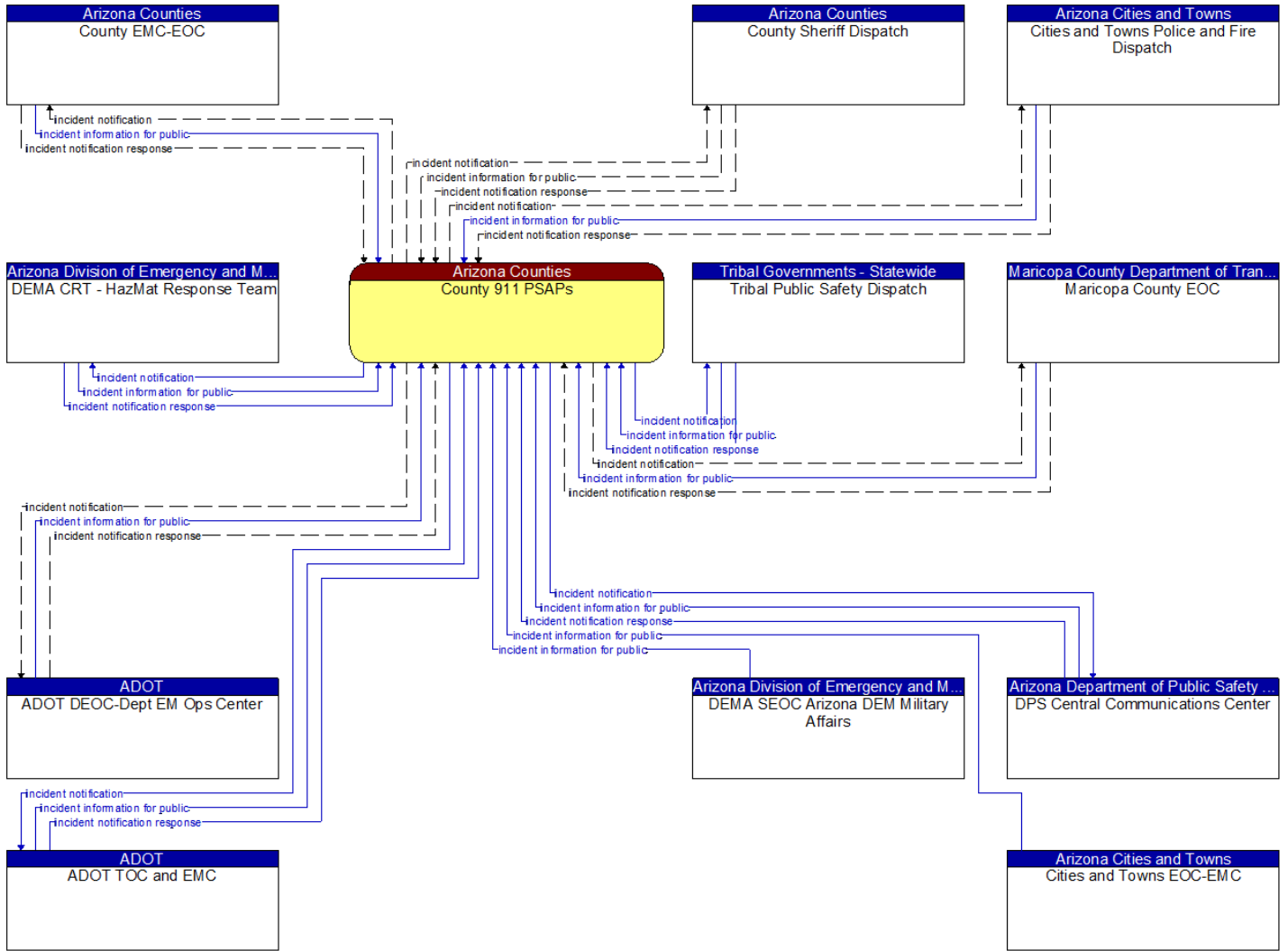

————— Existing
- - - - - Planned

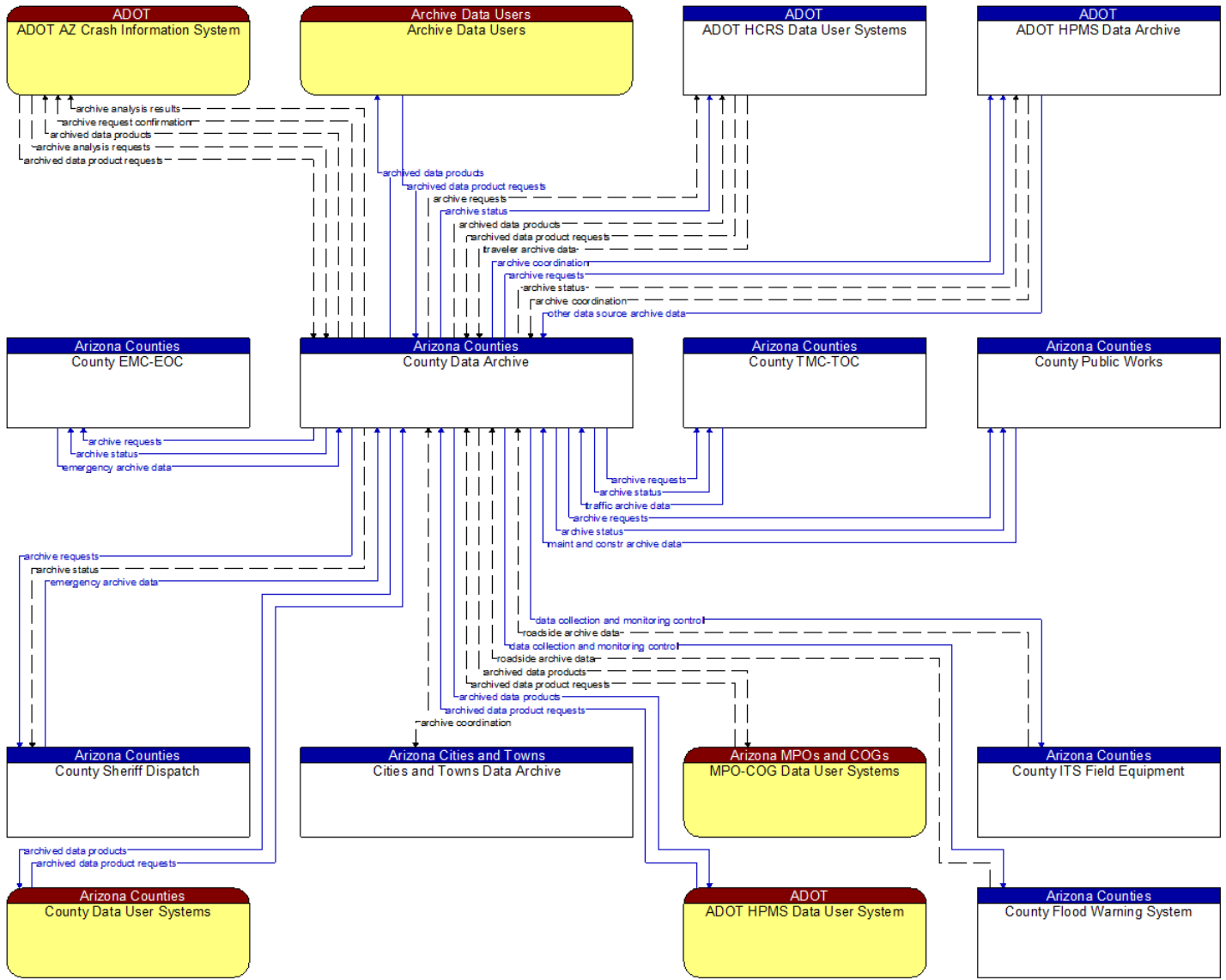

— Existing
- - - Planned

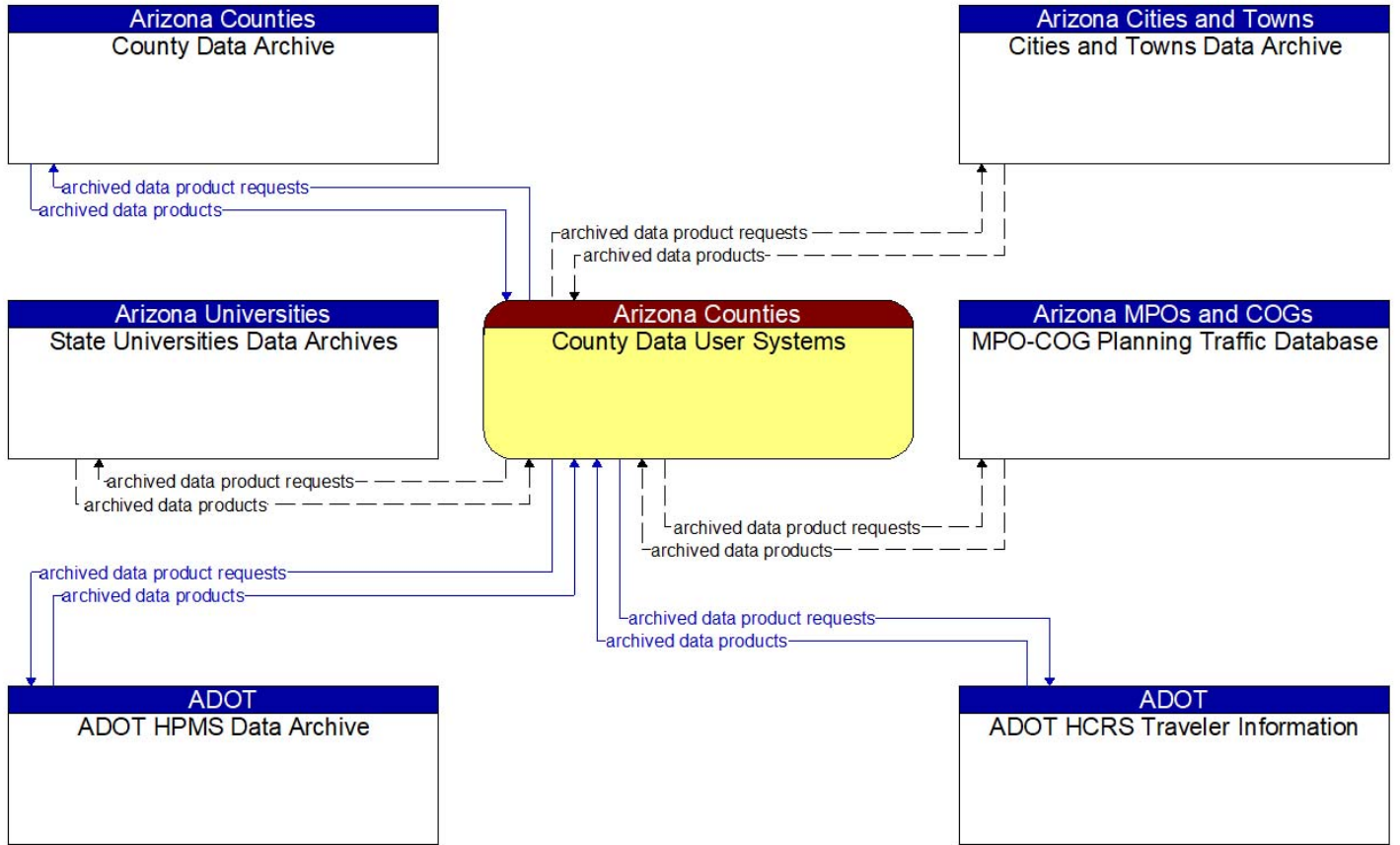

— Existing
 - - - Planned

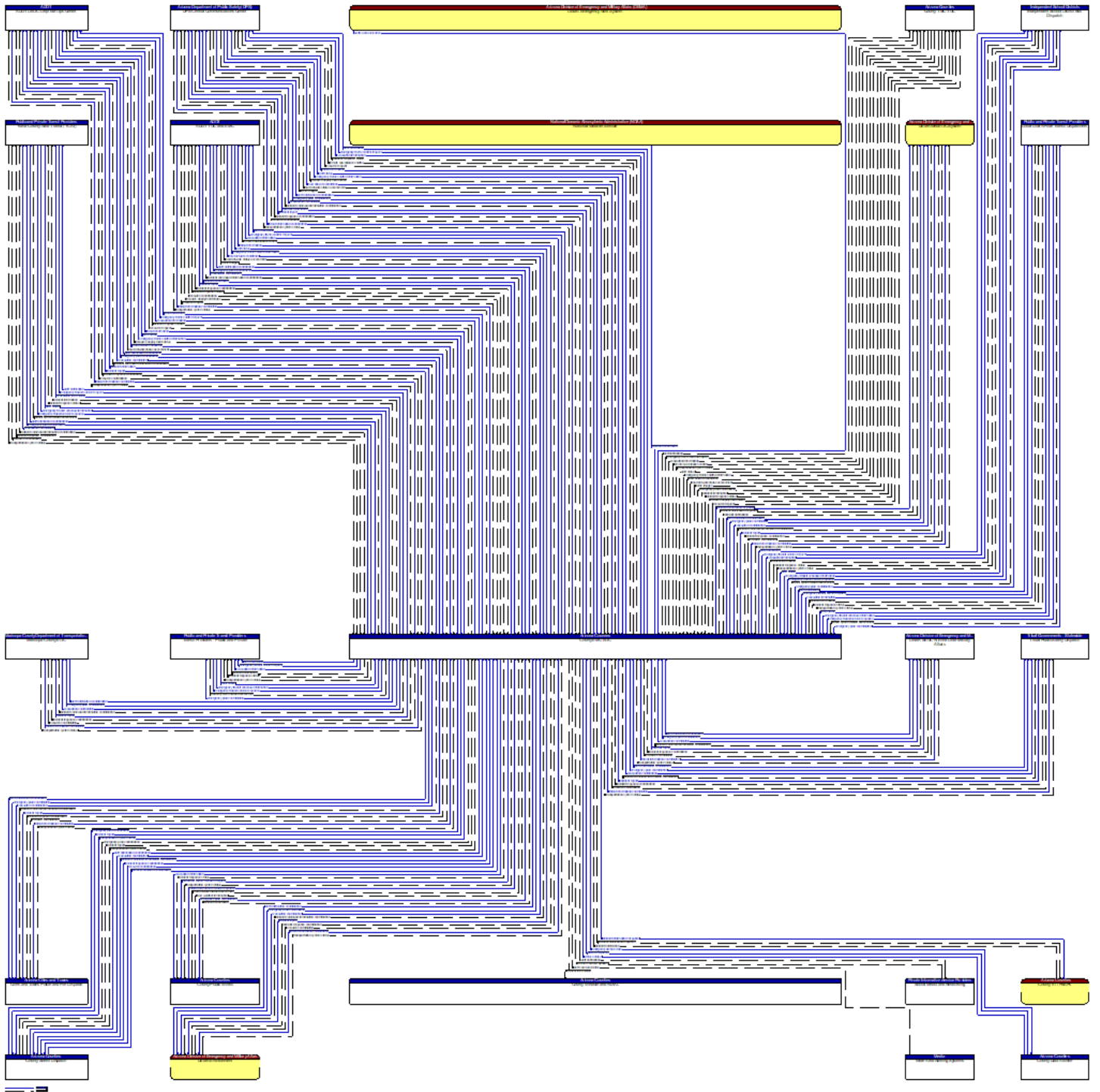

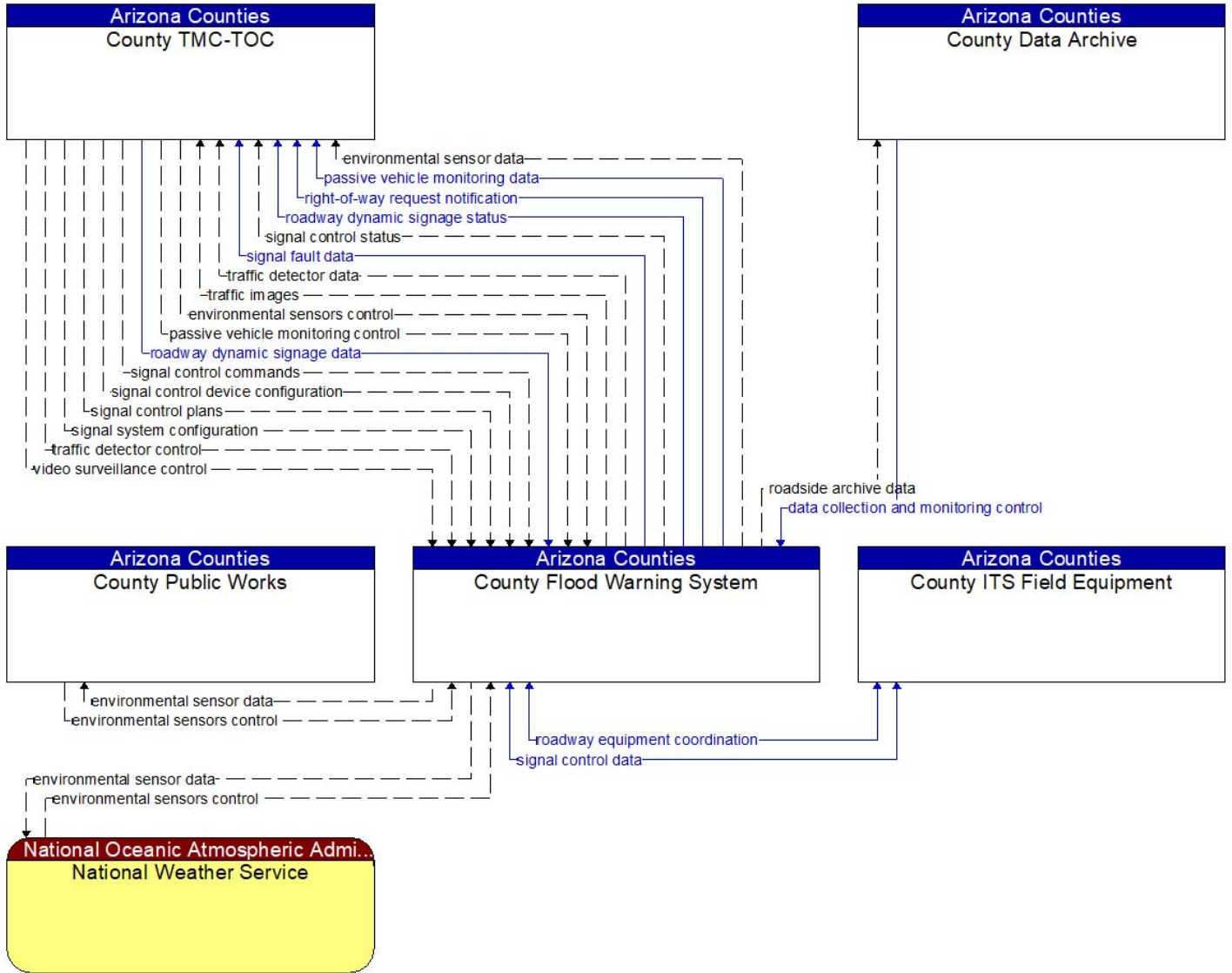

Existing
Planned

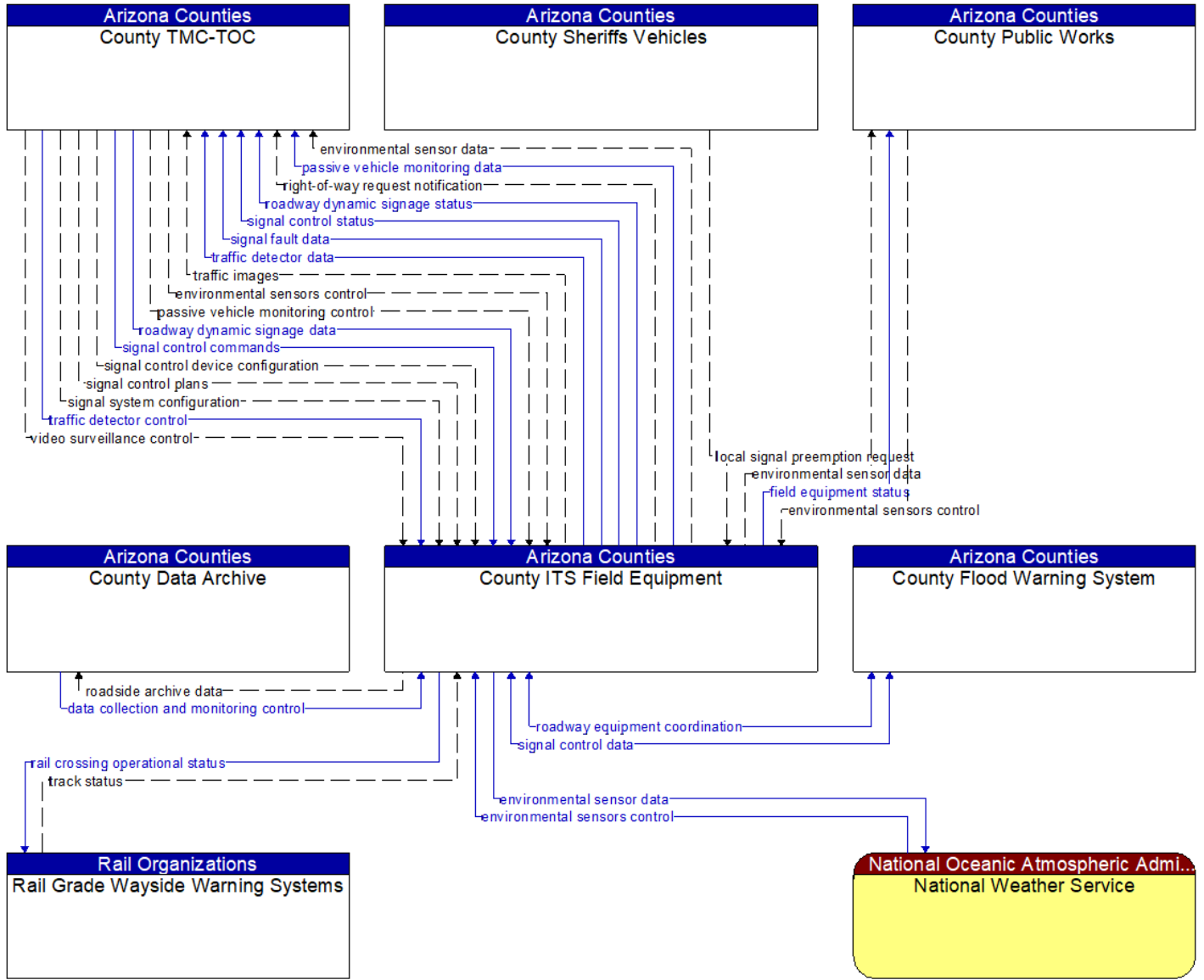

— Existing
 - - - Planned

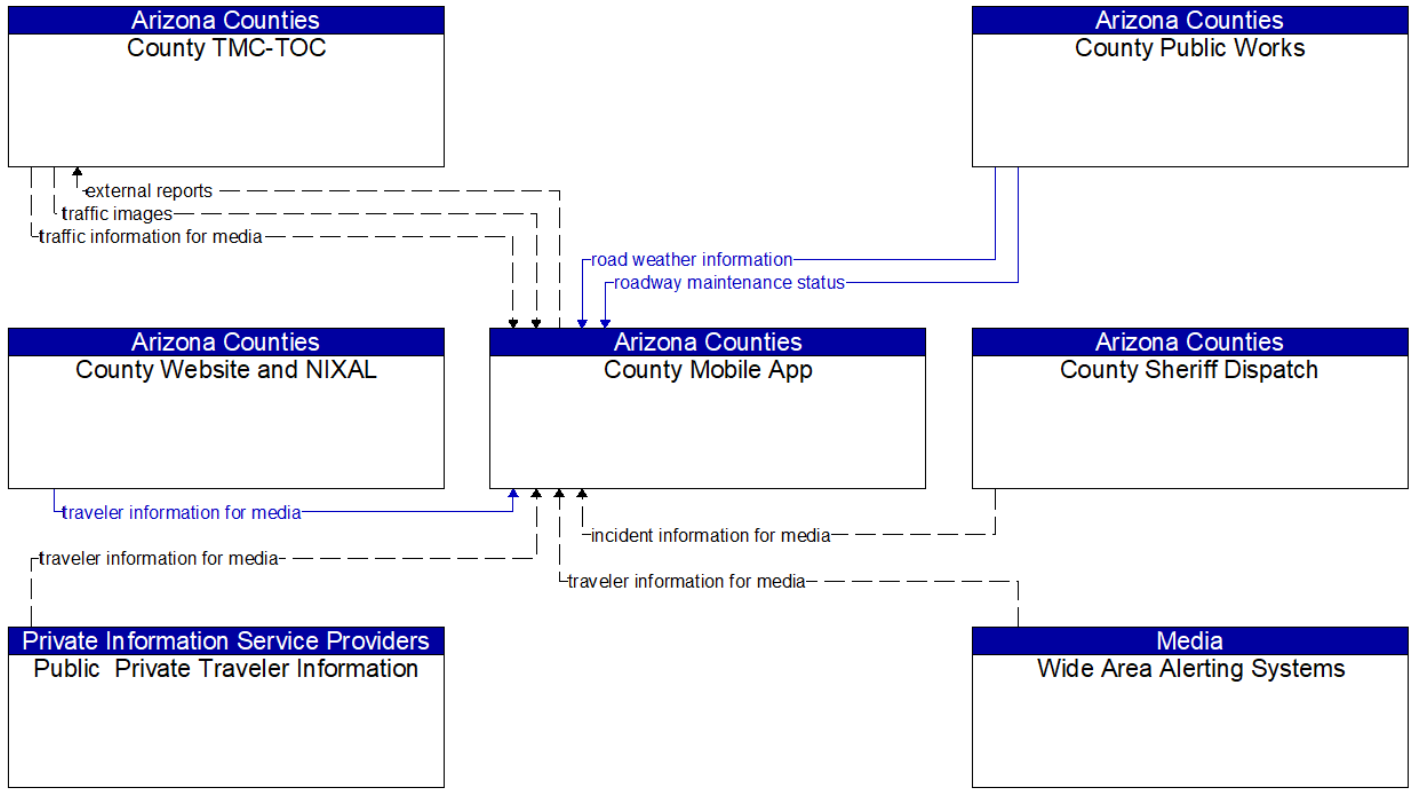

— Existing
 - - - Planned

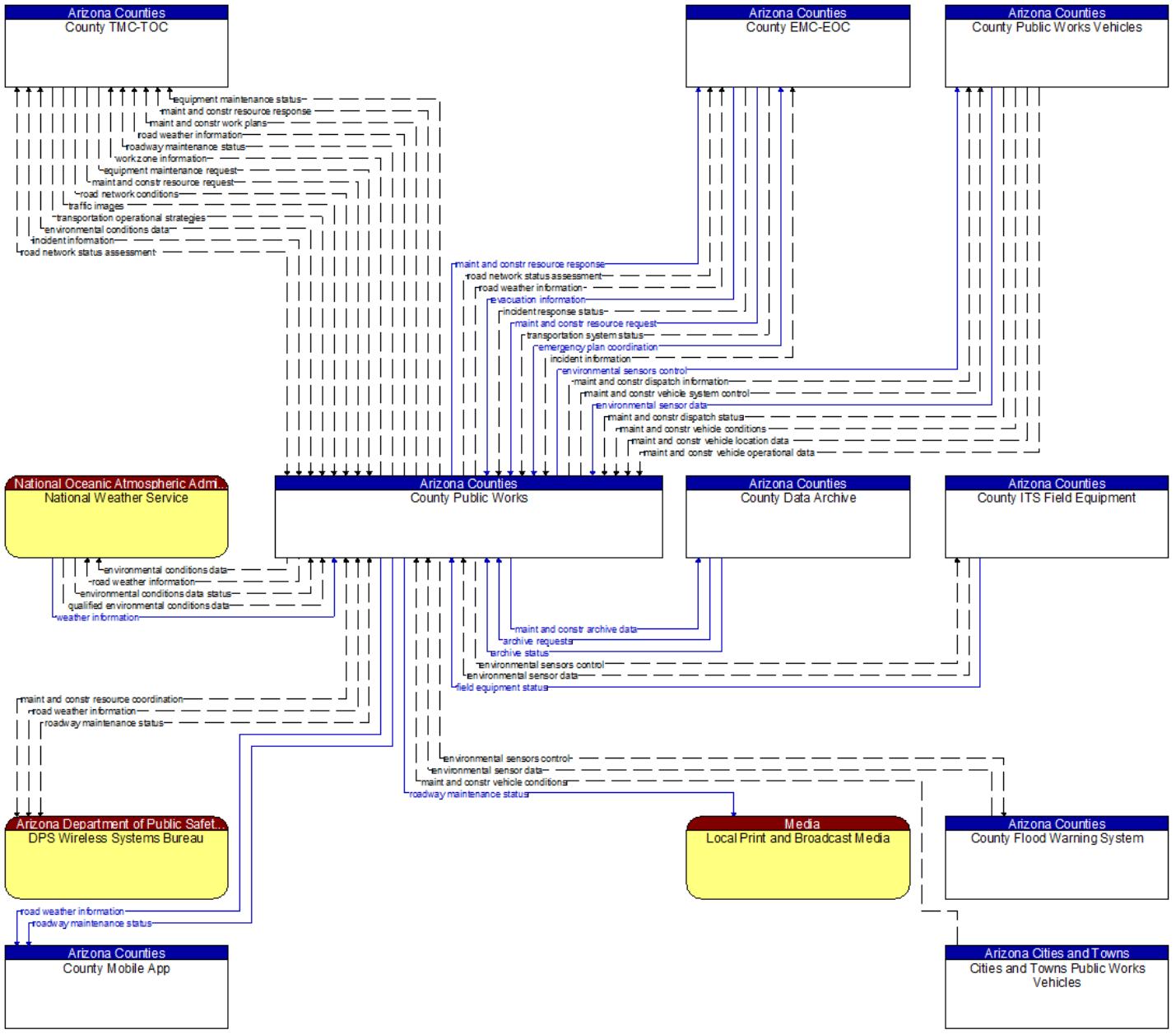

——— Existing
- - - - - Planned

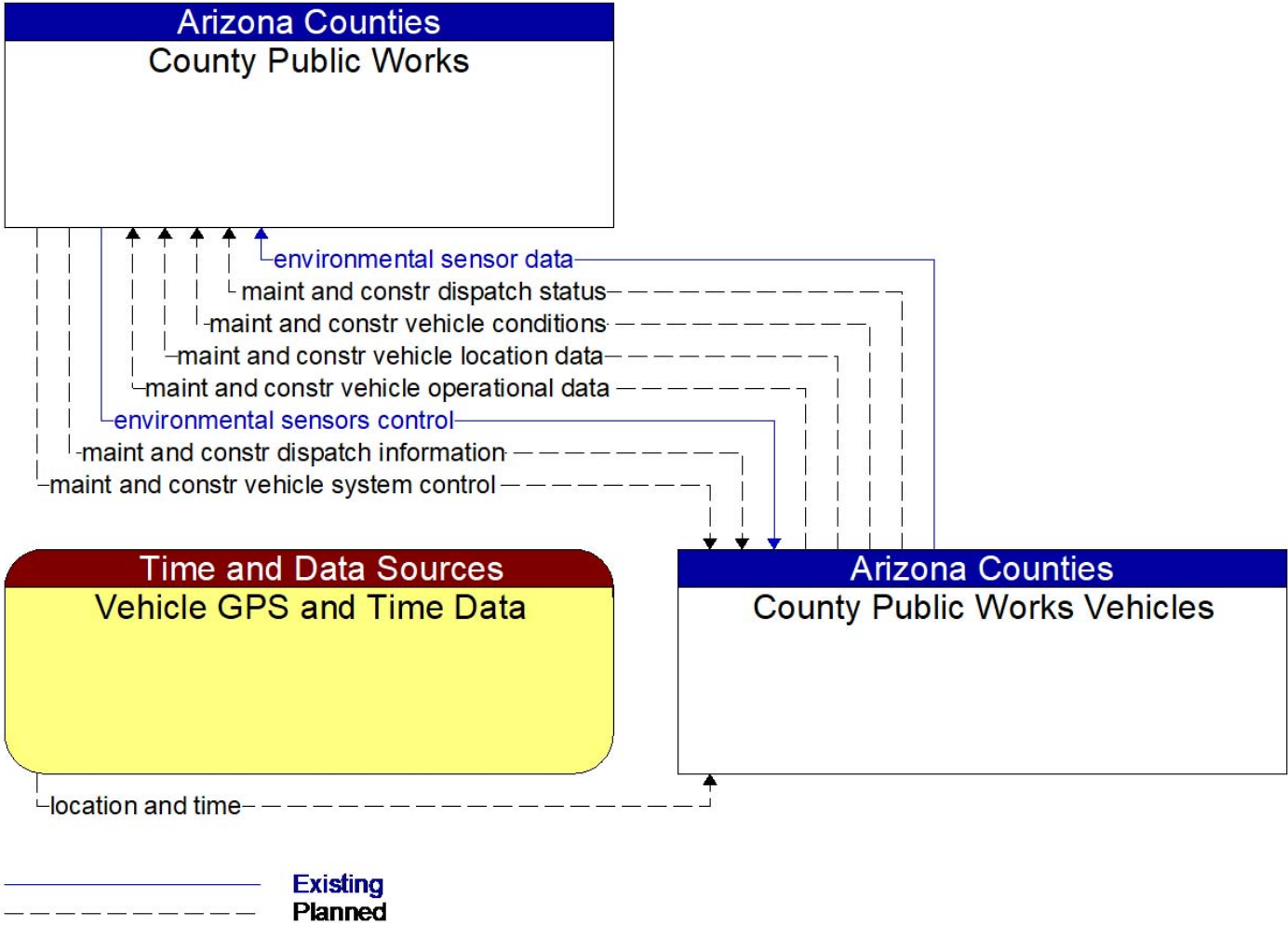

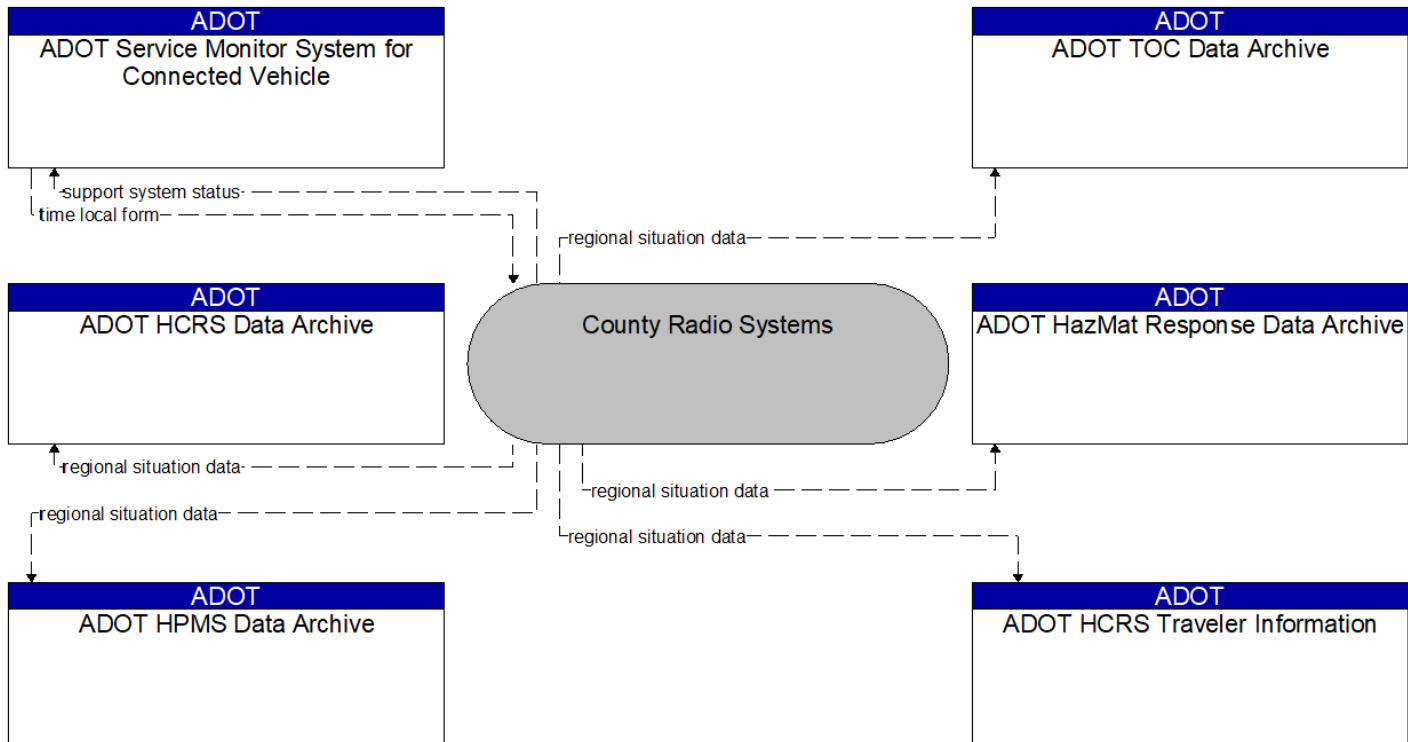

----- Planned

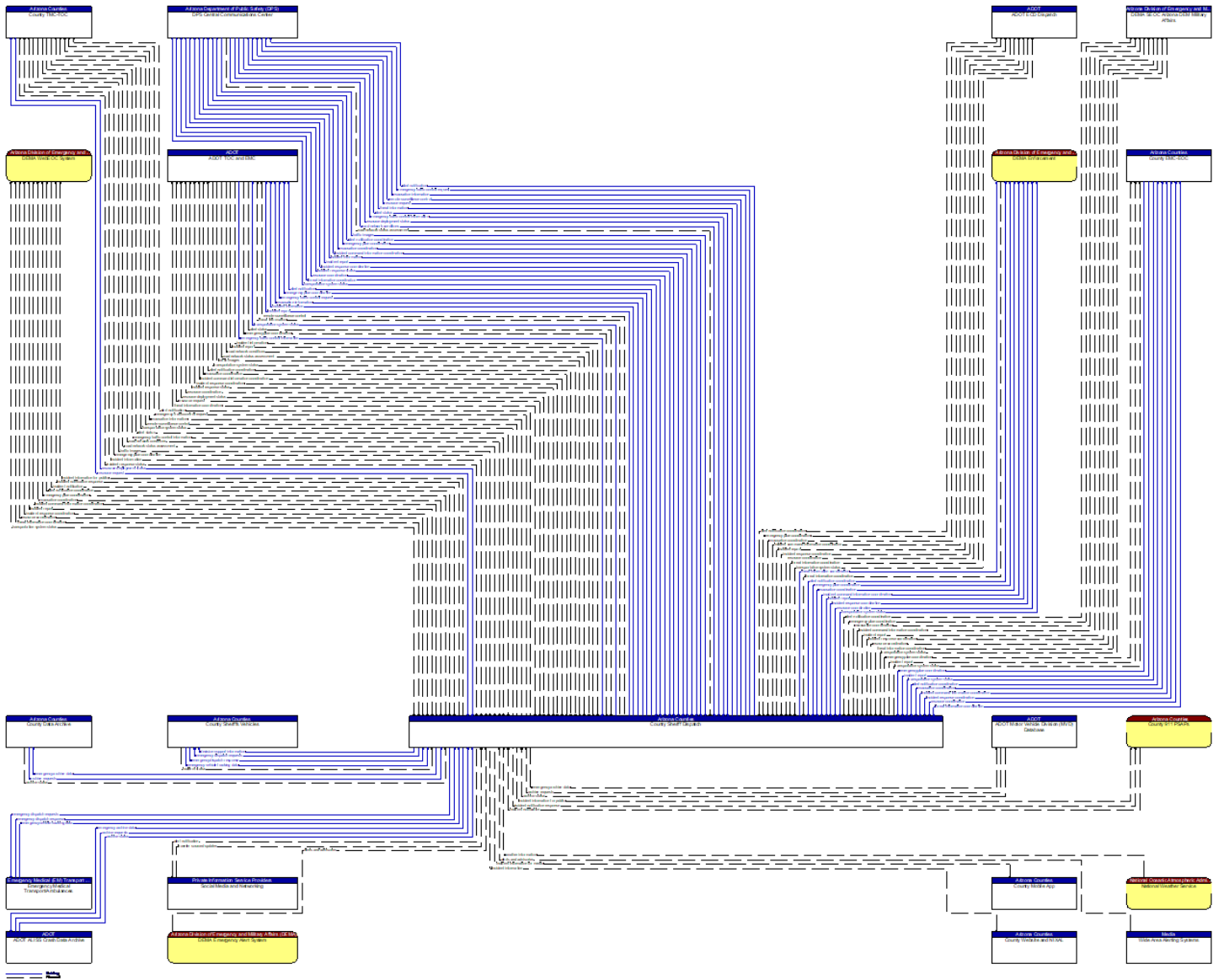

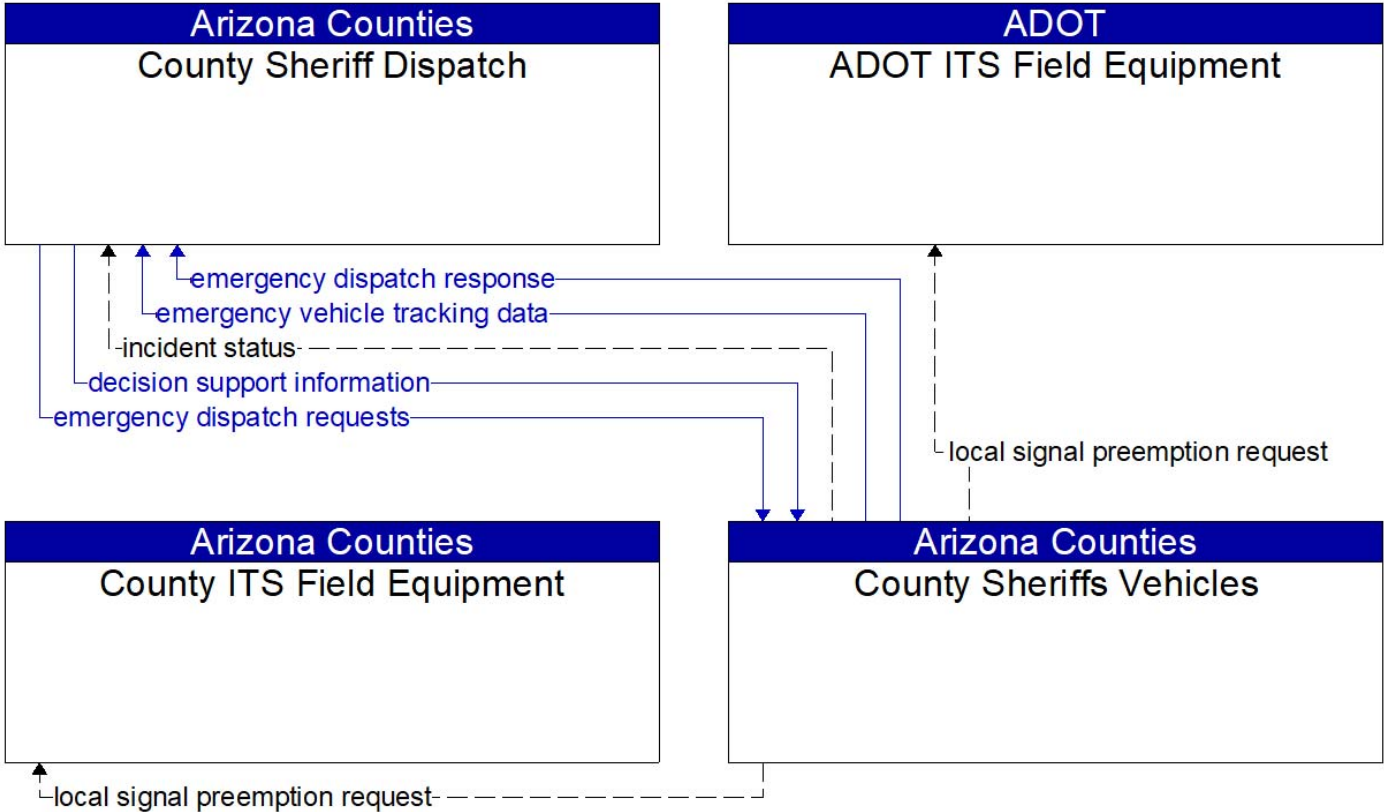

_____ Existing
 - - - - - Planned

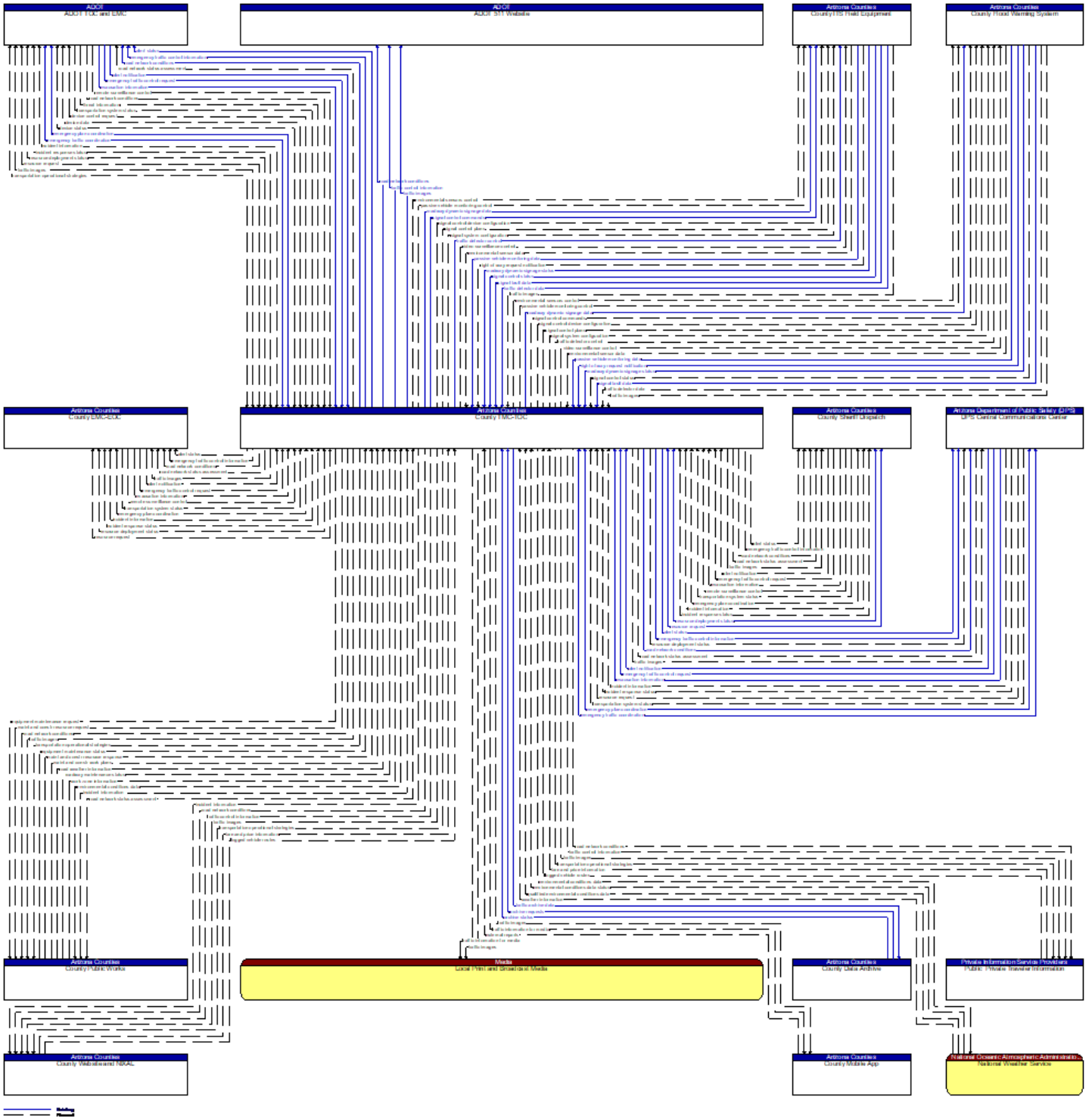

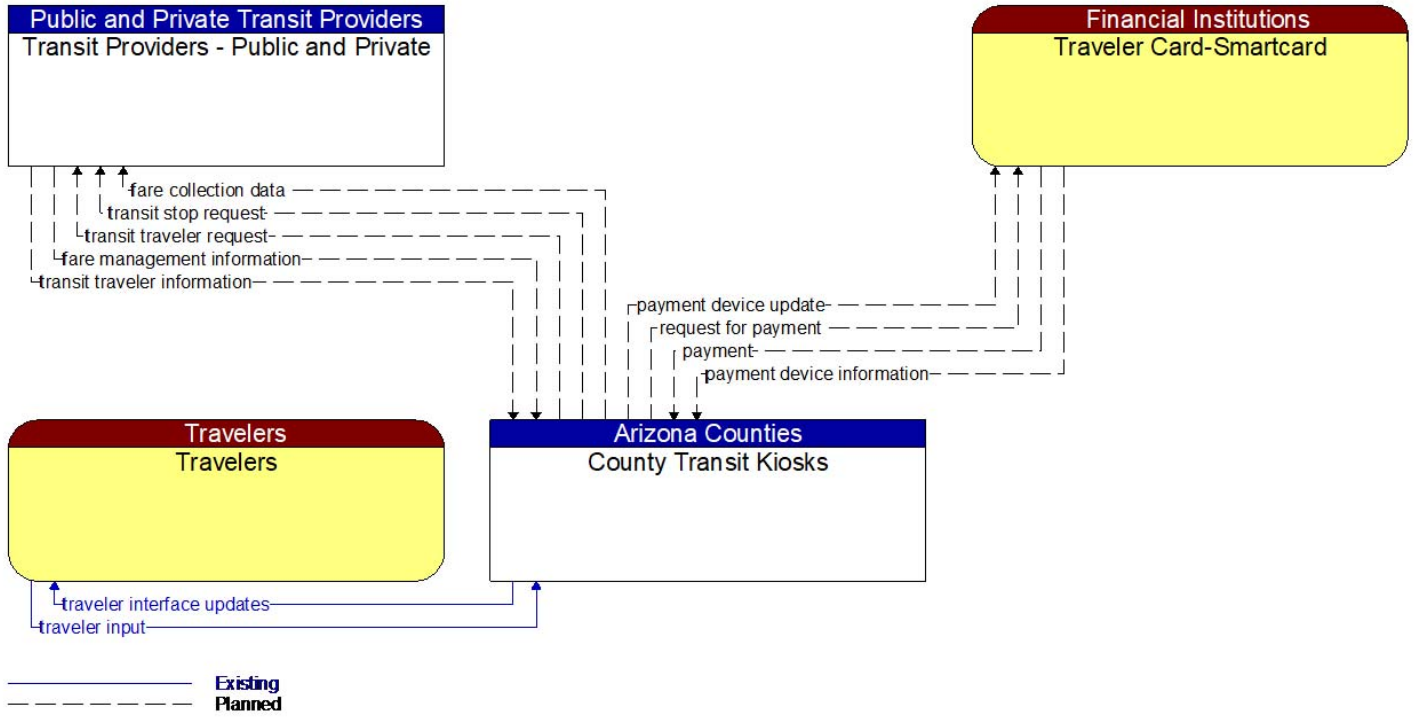

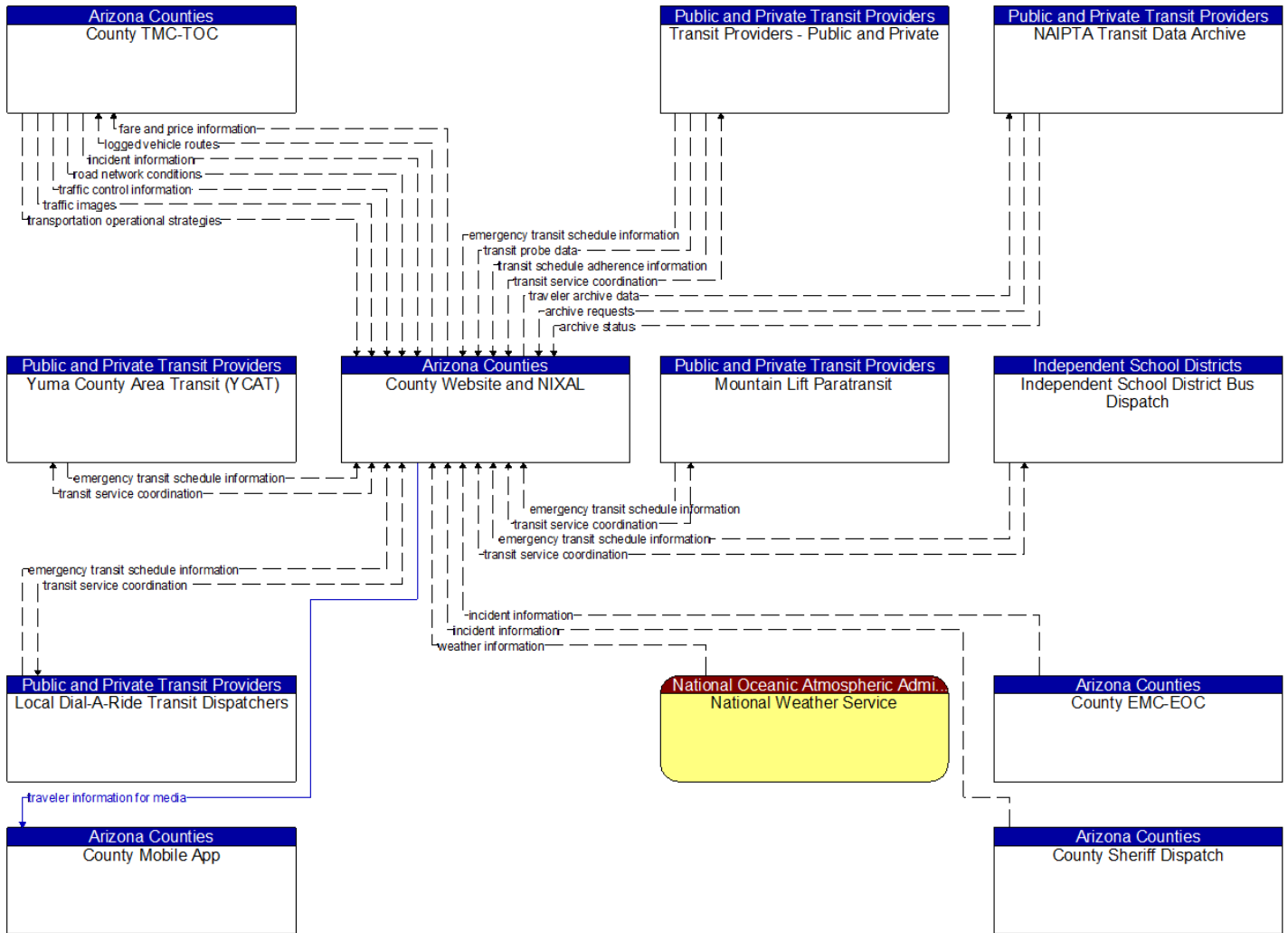

— Existing
 - - - Planned

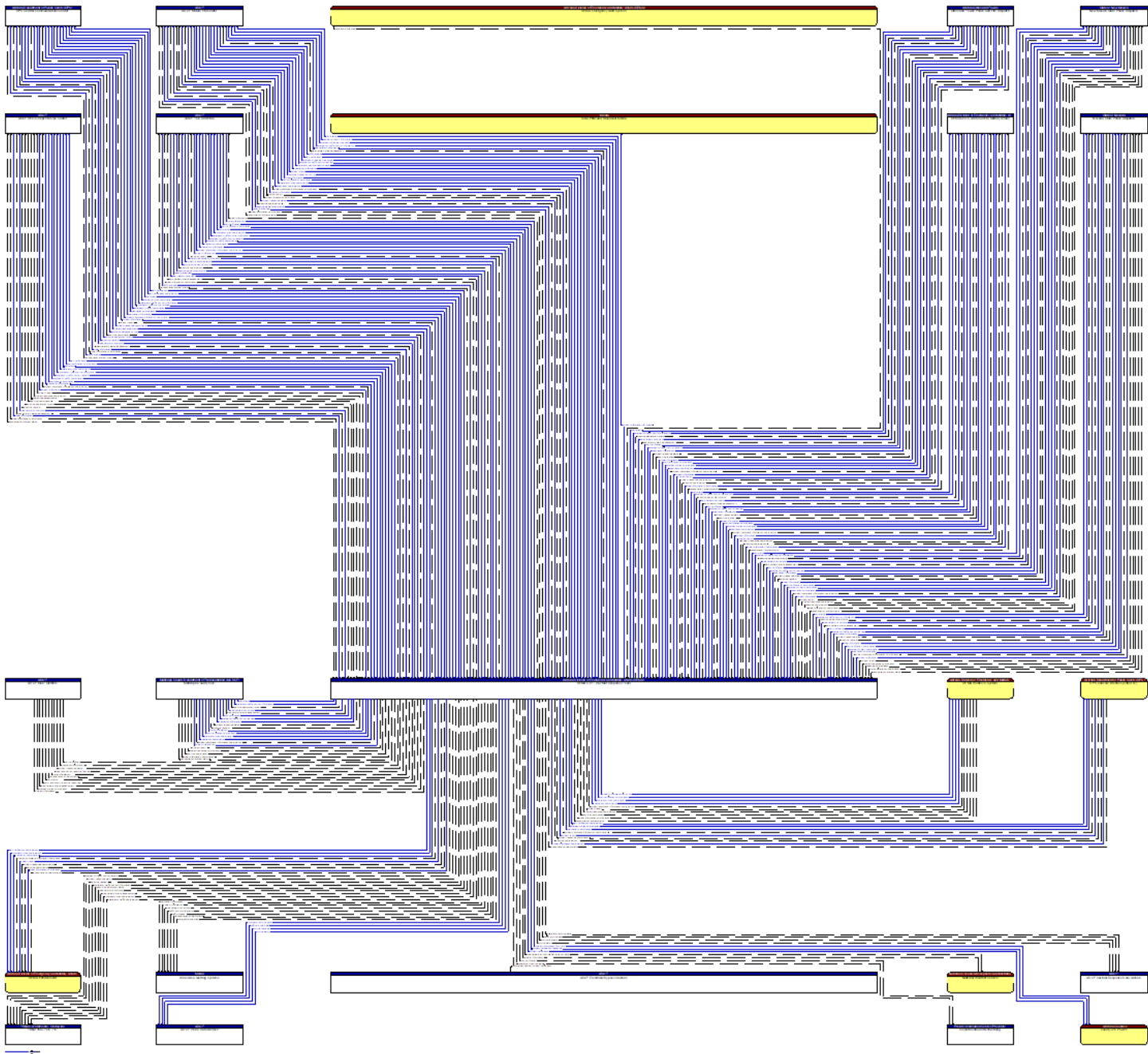

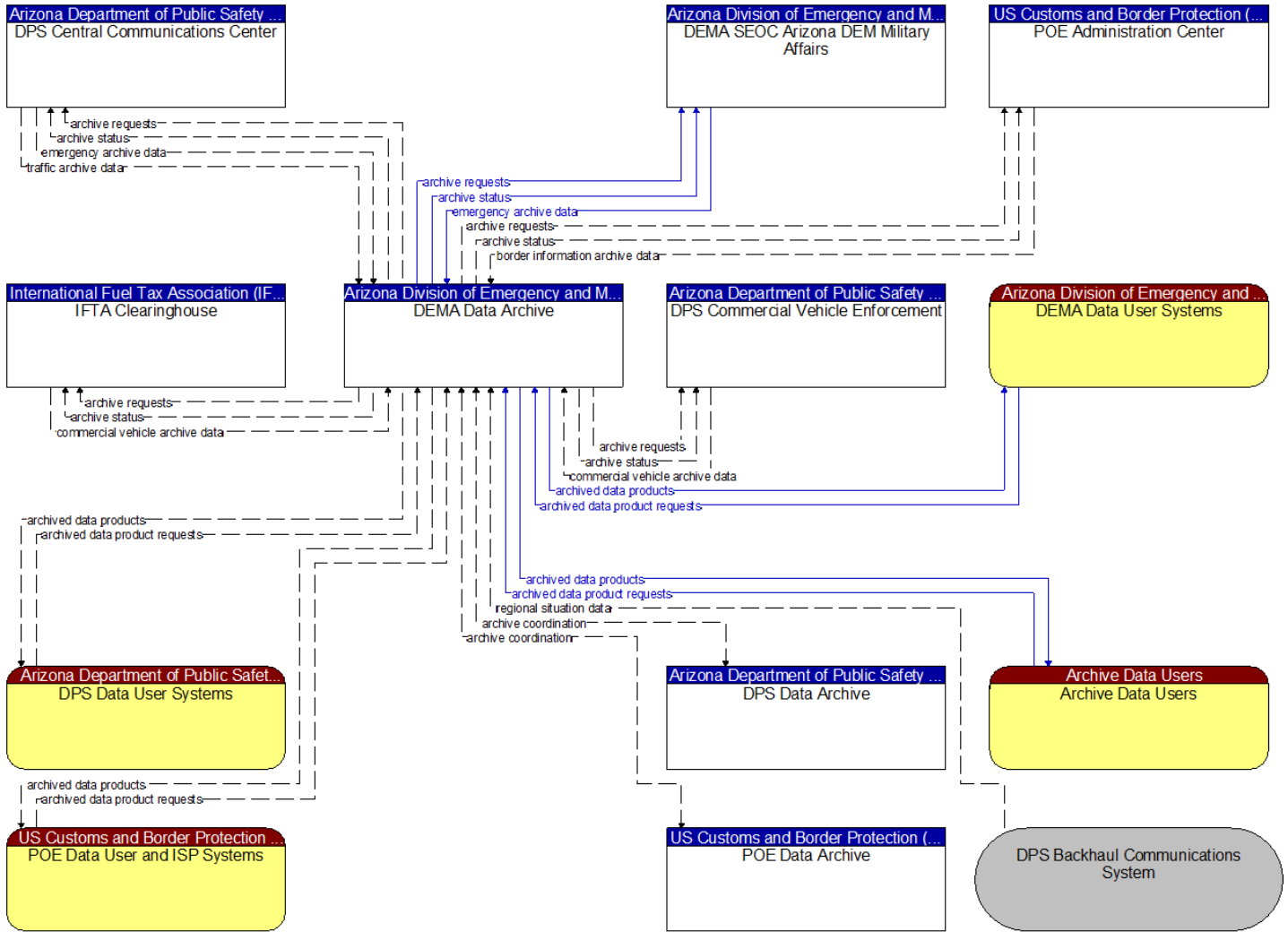

——— Existing
 - - - - - Planned

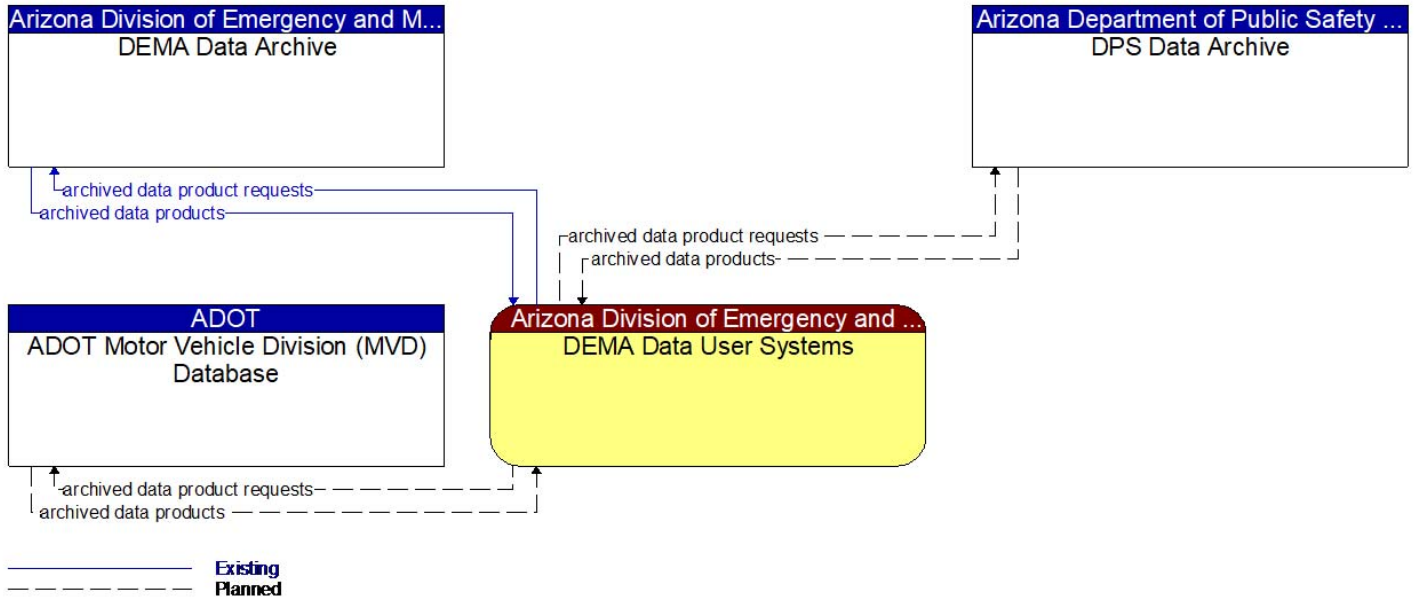
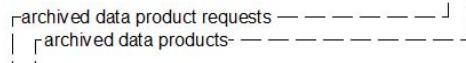
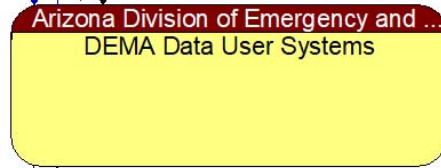
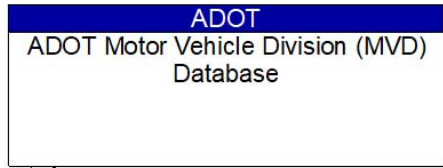
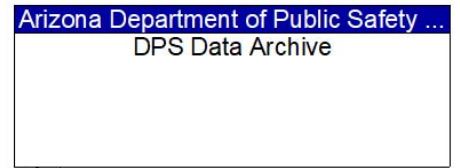
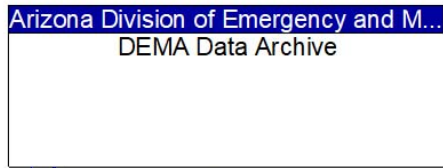

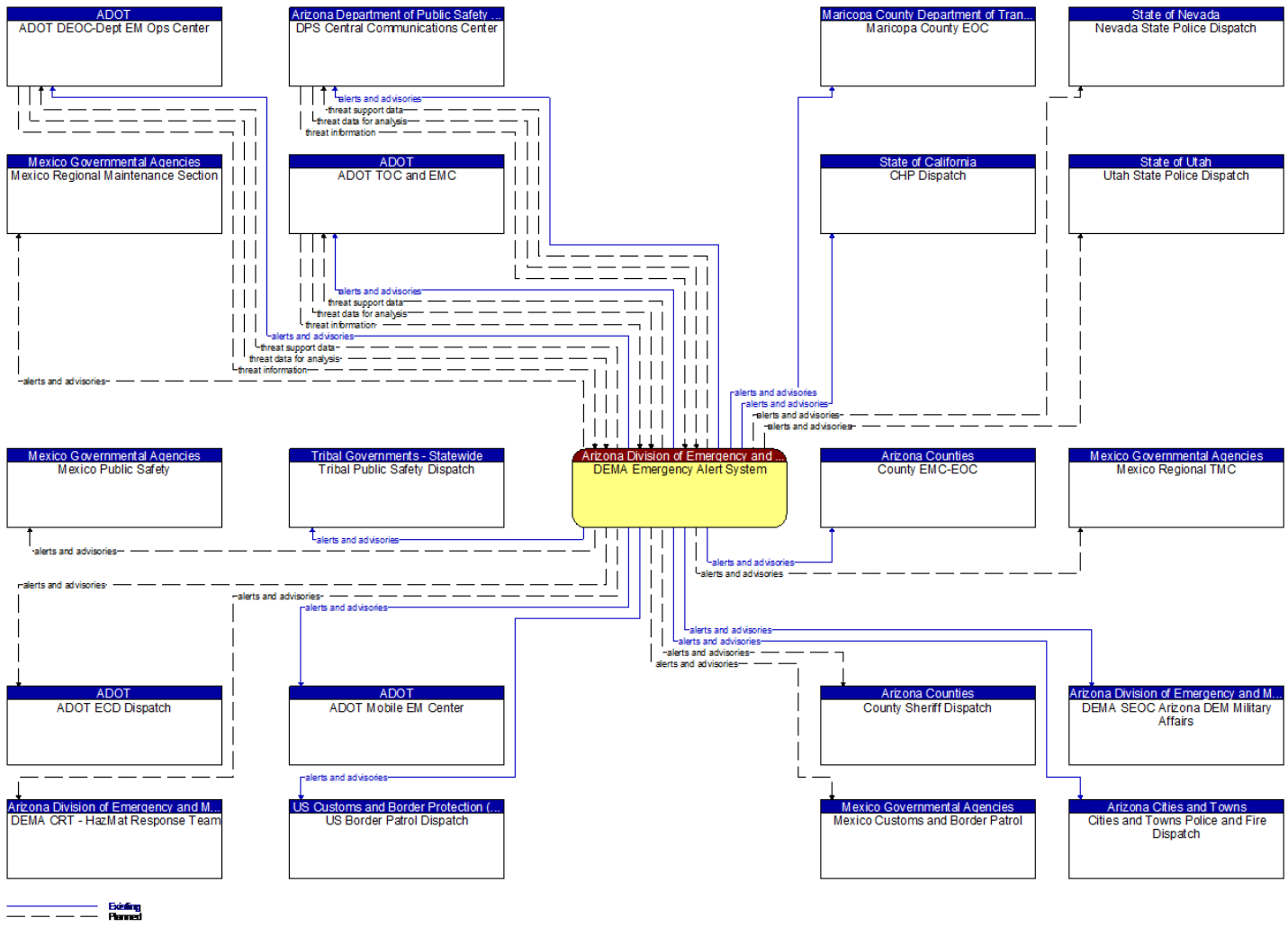

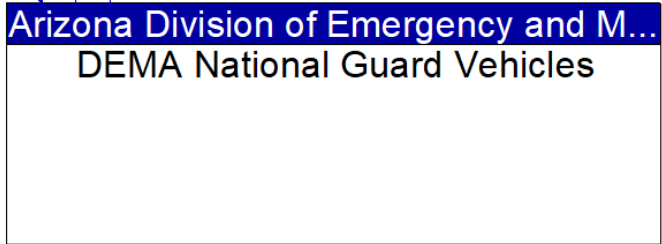
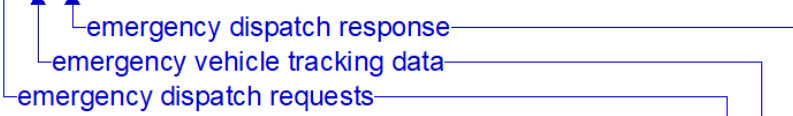
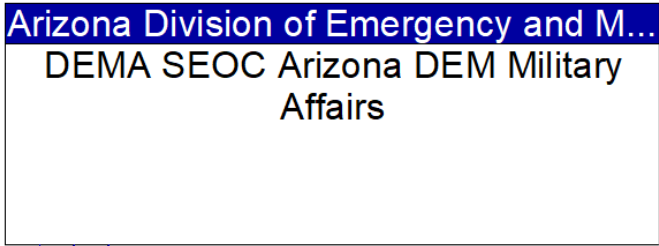

Existing