



Smart Work Zone (SWZ) Technical Concept Study

Phase No. 1

Final Working Paper 1 – Nationwide Review of SWZ Technologies

February 2019

Prepared By:

**Kimley»»Horn**



# TABLE OF CONTENTS

A. OVERVIEW .....	1
1 - Background .....	1
B. MAJOR CHALLENGES AND ISSUES WITH ARIZONA WORK ZONES .....	1
C. SWZ OVERVIEW .....	2
D. LITERATURE REVIEW .....	4
1 - Summarizing Smart Work Zone Efforts on a National Level .....	4
a. Reports and Articles on the FHWA Website.....	4
b. Reports published by FHWA and National Associations.....	5
2 - Summarizing Smart Work Zone Efforts on a State Level by ITS Applications .....	7
a. State DOT Smart Work Zone Guides .....	7
b. SWZ Applications.....	8
E. STATE DEPARTMENTS OF TRANSPORTATION USING SWZS .....	13
1 - Kansas Department of Transportation (KDOT) .....	13
2 - Iowa Department of Transportation (IOWADOT) .....	14
3 - Michigan Department of Transportation (MDOT) .....	14
4 - Texas Department of Transportation (TxDOT).....	15
F. SMART WORK ZONE VENDORS .....	15
1 - All Traffic Solutions .....	15
2 - ASTI Transportation Systems.....	15
3 - Wanco, Inc. ....	16
4 - Street Smart Rental .....	17
5 - Ver-Mac .....	17
6 - iCone.....	18
G. SWZ TYPICAL COSTS .....	19
H. SWZ COMMUNICATIONS.....	20
I. ADOT SWZ GOALS.....	21
J. ADOT SWZ OPERATIONAL CONCEPTS .....	21
1 - Determining the Need for a SWZ.....	21
a. Identifying Work Zones that Should be ‘Smart’ .....	21
b. Identifying SWZ Subsystems.....	22
2 - Recommended Technologies .....	23
a. Traffic Data Collection and GPS .....	25
b. Queue Warning .....	26
c. Dynamic Lane Merge.....	27
d. Travel Delay .....	28
e. Traffic Monitoring (Camera) .....	29
f. Variable Speed Limits .....	30
3 - Subsystem Integration Opportunities.....	31
K. PERFORMANCE MEASURES .....	31
L. REFERENCES.....	32

## APPENDIX A – FHWA SWZ DOCUMENTATION

## APPENDIX B – STATE DEPARTMENT OF TRANSPORTATION – SWZ GUIDELINES

# TABLE OF CONTENTS

<b>A. OVERVIEW</b>	<b>1</b>
1 - Background	1
<b>B. MAJOR CHALLENGES AND ISSUES WITH ARIZONA WORK ZONES</b>	<b>1</b>
<b>C. SWZ OVERVIEW</b>	<b>2</b>
<b>D. LITERATURE REVIEW</b>	<b>4</b>
1 - Summarizing Smart Work Zone Efforts on a National Level	4
a. Reports and Articles on the FHWA Website	4
b. Reports published by FHWA and National Associations	5
2 - Summarizing Smart Work Zone Efforts on a State Level by ITS Applications	7
a. State DOT Smart Work Zone Guides	7
b. SWZ Applications	8
<b>E. STATE DEPARTMENTS OF TRANSPORTATION USING SWZS</b>	<b>13</b>
1 - Kansas Department of Transportation (KDOT)	13
2 - Iowa Department of Transportation (IOWADOT)	14
3 - Michigan Department of Transportation (MDOT)	14
4 - Texas Department of Transportation (TxDOT)	15
<b>F. SMART WORK ZONE VENDORS</b>	<b>15</b>
1 - All Traffic Solutions	15
2 - ASTI Transportation Systems	15
3 - Wanco, Inc.	16
4 - Street Smart Rental	17
5 - Ver-Mac	17
6 - iCone	18
<b>G. SWZ TYPICAL COSTS</b>	<b>19</b>
<b>H. SWZ COMMUNICATIONS</b>	<b>20</b>
<b>I. ADOT SWZ GOALS</b>	<b>21</b>
<b>J. ADOT SWZ OPERATIONAL CONCEPTS</b>	<b>21</b>
1 - Determining the Need for a SWZ	21
a. Identifying Work Zones that Should be ‘Smart’	21
b. Identifying SWZ Subsystems	22
2 - Recommended Technologies	23
a. Traffic Data Collection and GPS	25
b. Queue Warning	26
c. Dynamic Lane Merge	27
d. Travel Delay	28
e. Traffic Monitoring (Camera)	29
f. Variable Speed Limits	30
3 - Subsystem Integration Opportunities	31
<b>K. PERFORMANCE MEASURES</b>	<b>31</b>
<b>L. REFERENCES</b>	<b>32</b>
<b>APPENDIX A – FHWA SWZ DOCUMENTATION</b>	
<b>APPENDIX B – STATE DEPARTMENT OF TRANSPORTATION – SWZ GUIDELINES</b>	

## LIST OF ACRONYMS

ADOT	Arizona Department of Transportation
ATIS	Advanced Traveler Information Systems
ATSSA	American Traffic Safety Services Association
CHIPS	Computerized Highway Information Processing System
CMS	Changeable Message Sign
DMS	Dynamic Message Sign
FHWA	Federal Highway Administration
HAR	Highway Advisory Radio
IDOT	Illinois Department of Transportation
ITS	Intelligent Transportation Systems
KDOT	Kansas Department of Transportation
MassDOT	Massachusetts Department of Transportation
SWZ	Smart Work Zone
TMC	Traffic Management Center
TMP	Transportation Management Plan
TOC	Traffic Operations Center
TTC	Temporary Traffic Control
TTI	Texas A&M Transportation Institute
TxDOT	Texas Department of Transportation
USDOT	United States Department of Transportation
VMS	Variable Message Sign
VSL	Variable Speed Limits
WZ	Work Zone
XML	Extensible Markup Language



## A. Overview

---

### 1 - Background

As part of Arizona Department of Transportation's (ADOT) Implementation Guidelines for Work Zone Safety and Mobility process review, ADOT is continually looking at ways to expand/enhance existing practices within work zones (WZ). Therefore, ADOT sought assistance to help develop and implement Smart Work Zone (SWZ) operational concepts. These concepts use a combination of intelligent transportation system (ITS) technologies that improve the safety of highway workers and the traveling public by optimizing WZ traffic operations. In addition, SWZ are deployed to minimize congestion by reducing delays to the motoring public within work zone areas.

ADOT has a long and proud history of being one of the nation's pioneers in the implementation of ITS, which began in the early 1990s with the deployment of ADOT Freeway Management System (FMS) Phase 1. ADOT has successfully applied these ITS operational tools to be used during construction WZs for many years, when construction is within the vicinity of ITS infrastructure. With recent advancements in SWZ technologies, ADOT is no longer limited by the reach of the state's permanent ITS infrastructure.

Although there are some core ITS operational principles used in deployments of SWZ systems, there are many operational and deployment considerations unique to SWZ technology applications. For example, ADOT should avoid burdening current Temporary Traffic Control (TTC) practices by simultaneously adding additional TTC devices (i.e., SWZ technologies) within the overall TTC plan.

## B. Major Challenges and Issues with Arizona Work Zones

---

Existing or historical challenges and issues that ADOT representatives at the Kick-Off Meeting have seen or experienced either as ADOT employees or as drivers on the roads:

- End of queue crashes occur beyond the first sign for a work zone ahead.
- Driver complying with traffic control is an issue. Travelers are ignoring signs.
- Speed limit non-compliance in work zones is an issue. Traveling speeds tend to increase further above the posted speed limits when posted speed limits are reduced for long stretches of a work zone and active workers are not present or are only present during a short stretch of a long work zone distance. Another example is when traffic control may need to be left up for curing for a period of time where workers may not be present.
- ADOT performs numerous rolling work zone applications each year. These applications consist of construction activities that last a short duration of time and move frequently such as pavement preservation projects where the work zone is continually moving or blasting operations where a small area on the roadway is closed for a short duration. Challenges with these types of set-ups include continual movement of the barricades, short durations where traffic is halted and driver speeding compliance.
- Traffic control non-compliance is an issue. When traffic control is left up (for curing or other longer-term purpose), ADOT needs to make sure it is all still there and compliant.
- More and better information to the traveling public. Accuracy of messages provided can be a challenge (incident notification does not actually mean incident is still there, travel times can be off, etc.).
- Need surveillance at work zones. ADOT receives traveler complaints due to work zones and have no eyes or data to determine what is happening at work zones.

- Need data collection to be able to calculate queue lengths and queue times for statewide reporting requirements. This is the same traveler complaint issue.
- Detour routing into areas that may or may not be able to take freeway traffic or accommodate large truck turning radius, weight, or height.
- Lane restrictions can be challenging especially for oversized vehicles. Need to maintain minimum width restrictions. This may require a change to ADOT's policy on temporary traffic control.
- Need to record all work zones in HCRS to make HCRS a more complete account of restrictions on the roadways.

Other issues that may or may not be applicable to smart work zones but are important to capture:

- Training for proper traffic control application.
- Pedestrians crossing work zones

## C. SWZ Overview

---

Governmental agencies are finding ways to reduce traffic congestion and traveler delays caused by the reduced roadway capacity within work zones. One strategy is the deployment of portable and temporary intelligent transportation systems in and around work zones; this concept is known as smart work zones. According to a report published by Federal Highway Administration (FHWA), SWZs have the capability to provide significant benefits to agencies and to those affected by the mobility reduction. Those benefits include safety, mobility, improved work productivity and durability, and customer satisfaction (Ullman, Schroeder and Gopalakrishna, Work Zone Intelligent Transportation Systems Implementation Guide 2014). As best described in the Massachusetts Department of Transportation (MassDOT) Smart Work Zone Design Standards, SWZs are portable combinations of equipment designed for flexible deployment in work zone environments (Massachusetts Department of Transportation 2016). SWZs typically consist of four features:

- **Detection and surveillance equipment** that collect speeding and queuing data and video near the work zone and send data to the central processing system.
- **Central processing system** that analyzes, processes and stores the traffic data. The central processing system also pushes messages to the public through signs and other dissemination outlets.
- **Dissemination outlets** on and off the road that make real-time information about work-zone conditions available to the public and governmental agencies.
- **Ancillary systems** provide power to the equipment and communications between the components of the system.

Combining these four features, **Table 1** provides a listing of general SWZ application concepts and describes the ITS components necessary for each application. At the Smart Work Zone Technical Concept Study Kick-Off Meeting held on November 9, 2018, Arizona Department of Transportation (ADOT) SWZ stakeholders decided that the subsystem concepts listed below should be selected for further review. SWZ subsystems can be deployed individually or together depending upon user needs, expected traffic delay, and operational concerns within the work zone. In addition, the ITS components for the subsystems can be used for dual purpose. As an example, a changeable message sign (CMS) may notify drivers that a queue is developing with slow motorists ahead, during peak periods of the day and return to a general advisory message during the off peak travel demand periods.

**Table 1: SWZ Applications**

SWZ Applications	Description	ITS Components	Issues Addressed
<b>Queue Warning System</b>	This system detects the presence of congestion at the work zone and warns approaching motorists that traffic is slowed or stopped ahead.	<ul style="list-style-type: none"> <li>• Traffic Detectors</li> <li>• Data Processing</li> <li>• CMS</li> <li>• Communications</li> </ul>	<ul style="list-style-type: none"> <li>• Safety (rear-end crashes)</li> </ul>
<b>Variable Speed Limits (VSL)</b>	VSL harmonizes speeds before and within the work zone, calming traffic and warning of slowed or stopped traffic ahead.	<ul style="list-style-type: none"> <li>• Speed Detectors</li> <li>• Data Processing</li> <li>• VSL Signs &amp; CMS</li> <li>• Communications</li> </ul>	<ul style="list-style-type: none"> <li>• Safety</li> <li>• Speed Management</li> </ul>
<b>Dynamic Lane Merge</b>	This component encourages motorists to merge at specific points as they approach a lane closure, depending upon current operating conditions.	<ul style="list-style-type: none"> <li>• Traffic Detectors</li> <li>• Data Processing</li> <li>• CMS</li> <li>• Communications</li> </ul>	<ul style="list-style-type: none"> <li>• Delay</li> <li>• Aggressive driving behavior</li> <li>• Safety</li> <li>• Queue length</li> </ul>
<b>Traffic Data Collection</b>	Traffic data to be collected may include traffic volumes, speed, travel time, and vehicle classification.	<ul style="list-style-type: none"> <li>• Traffic Detectors</li> <li>• Data logging</li> <li>• Communications</li> </ul>	<ul style="list-style-type: none"> <li>• Evaluation</li> <li>• Performance</li> </ul>
<b>Travel Time/Delay</b>	Travel time/delay systems calculate the amount of time a motorist is delayed by a work zone.	<ul style="list-style-type: none"> <li>• WiFi/Bluetooth Detectors</li> <li>• Traffic Detectors</li> <li>• Data Processing</li> <li>• CMS</li> <li>• Communications</li> </ul>	<ul style="list-style-type: none"> <li>• Reduced driver frustration</li> <li>• Reduced congestion and delay</li> <li>• Driver's ability to reroute</li> </ul>
<b>Traffic Monitoring (video)</b>	This system monitors traffic using video and provides images/live stream back to a central system or TMC.	<ul style="list-style-type: none"> <li>• Cameras</li> <li>• Communications</li> </ul>	<ul style="list-style-type: none"> <li>• Improved incident detection/response</li> <li>• Reduced secondary crashes</li> </ul>
<b>Entering/Exiting Vehicle Notification</b>	This notification warns drivers of slow moving construction vehicles that may be entering the travel lane. It can also warn travelers that a work vehicle is exiting the travel lane and not to follow it into the work space.	<ul style="list-style-type: none"> <li>• Detectors</li> <li>• CMS</li> <li>• Communications</li> </ul>	<ul style="list-style-type: none"> <li>• Increased safety of construction workers</li> <li>• Reduced vehicle collisions with construction equipment</li> </ul>
<b>Real Time Traveler Information</b>	This system provides drivers with real time travel conditions prior to and within a work zone. Information may be obtained from the applications listed above or may consist of information on alternative routes, incident information, or site specific construction information (blasting) to divert drivers away from the work zone when congestion exists.	<ul style="list-style-type: none"> <li>• Traffic Detectors</li> <li>• Data Processing</li> <li>• CMS</li> <li>• Communications</li> </ul>	<ul style="list-style-type: none"> <li>• Reduced congestion and delay</li> <li>• Credible real-time information</li> <li>• Improved safety</li> <li>• Enhanced driver awareness</li> <li>• Improved communication with motoring public</li> </ul>

(source: Ullman, Schroeder and Gopalakrishna modified by UCG November 2018)

As part of Working Paper #1, a literature review was performed to summarize smart work zone efforts on a national level, identify SWZ subsystems that leading state DOTs are deploying, and document the various SWZ components, software, and systems that SWZ manufacturers and vendors have to offer. In addition, this working paper provides general cost estimates for the various SWZ subsystems. The costs were based on interviews with the state DOTs, manufacturers, vendors and equipment rental suppliers.

## D. Literature Review

---

For over 20 years, national and state leaders in SWZ applications have been researching and documenting their benefits. Therefore, this literature review was prepared to identify guidelines and processes on a national level, determine the current SWZ deployment applications and understand SWZ practices throughout the nation, and to identify vendors within the industry that rent or sell SWZ ITS components and systems. This literature review gives a general understanding of the existing SWZ technologies, applications and components; what they typically cost to deploy, operate and own; and how other agencies applied these concepts to improve work zone operations and safety.

### 1 - Summarizing Smart Work Zone Efforts on a National Level

#### a. Reports and Articles on the FHWA Website

Multiple reports and articles published on the US Department of Transportation Federal Highway Administration (FHWA) website generally describe SWZs nationally. These reports provide concepts, overviews, guidance and benefits of SWZ. The reports introduce the need to provide drivers with real time information within a work zone and describe the characteristics of a smart work zone system (Pant 2017). Based on these reports, a smart work zone system should possess the following general characteristics: obtain and analyze traffic data in real-time, providing frequently updated information to motorists; remain portable; operate in an automated manner with as minimal supervision as possible by human operators; and provide accurate and reliable information. When SWZ are designed and implemented properly, motorists are better informed with less frustrations, drivers use alternate routes where feasible, congestion is reduced, incidents are cleared faster and overall, work zones are safer for highway workers and motorists. These reports and articles also provide challenges and tips to deploying technology. Some of the challenges listed are costs of deployment, troubleshooting/maintenance of the portable ITS components of the system, wide range of ITS equipment and detector types to choose from, and the variation of work zone needs (Scriba and Atkinson, Creating Smarter Work Zones March/April 2014). A few useful SWZ reports/articles are included in **Appendix A – FHWA SWZ Documentation**.

- Creating Smarter Work Zones by Tracy Scriba and Jennifer Atkinson, March/April 2014.
- Improving Work Zones Every Day, in Every Way by Jawad Paracha and Rachel Ostroff, 2018.
- Smart Work Zone Systems by Prahlad Pant, PhD, February 2017.

In 2015, FHWA launched the Smarter Work Zones initiative, promoted by Every Day Counts, to encourage agencies to better design, plan, coordinate and operate work zones. Two strategies for SWZ include (1) project coordination to harmonize construction projects and reduce work zone impacts (2) technology applications to dynamically control traffic in and around work zones (Paracha and Ostroff Summer 2018). This initiative promoted effective traffic management during construction and has found that the operational and safety benefits can be significant, especially in metropolitan regions and high impact corridors during special events (USDOT Federal Highway Administration 2017). Benefits of these two strategies include minimizing travel delays, enhancing safety of motorists and workers, and maintaining business and resident access. According to FHWA's Work Zone Management Program, VSLs or advisories

had been used on at least 30 interstate corridors in 14 states through 2017. In addition, 10 states implemented queue management systems that generated accurate and dependable travel times.

## **b. Reports published by FHWA and National Associations**

In 2002, FHWA researchers examined real work experiences at four locations (Michigan, Illinois, New Mexico, Arkansas) using ITS in work zones across the nation (USDOT Federal Highway Administration 2002). The four case studies were presented in detail that showed ITS technologies make a difference in reducing crashes, reducing delays and reducing costs when used in work zones. This study also identified lessons learned from the four projects that were common to most of, if not all, the systems. (1) Systems need to have reliable communications (2) It is important to allow start-up time when deploying a system. (3) Use a proactive approach in building public awareness of the project and the information that the ITS application will provide. (4) It is vital to deliver accurate information to the public. (5) Other stakeholder agencies, such as those responsible for incident management, need to be involved early. (6) Consider how to set up automated information delivery and sharing with other agencies.

Four FHWA case-study reports, prepared in 2004, were reviewed that address various ITS components of SWZs. The case study reports provide a system description, identify specific equipment used, and present system performance and the benefits and impacts to mobility, safety, and cost savings. The first case-study for the Interstate 40/Interstate 25 interchange (Big I) in Albuquerque, New Mexico, focused on a mobile traffic monitoring and management system to assist with the movement of 300,000 vehicles daily and provided delay and routing information to drivers and agency personnel. (USDOT Federal Highway Administration 2004). The second case study involved using ITS to support work zone operations during the reconstruction and widening of SR 68 in Northern Arizona and used travel time as incentive/disincentive (USDOT Federal Highway Administration, 2004). The system used automated license plate recognition and matching computer analytics with one monitoring station at the beginning and one at the end of the project limits. The third case study was performed during the re-build of a large section of Interstate 94 in Clinton Township, Michigan. This SWZ effort deployed dynamic lane merge to help smooth traffic and reduce aggressive driving prior to the transition into the construction area (USDOT Federal Highway Administration 2004). With this effort, Michigan observed a decrease in aggressive maneuvers and a lower average peak period travel time. The final case study focused on a real time traffic control system to reduce congestion and improve safety on Interstate 55, just south of Springfield, Illinois. The system included real time traveler information and a speed reduction within the work zone (USDOT Federal Highway Administration 2004). Illinois Department of Transportation (IDOT) reported that the system provided safety benefits due to the decreased number of moving violations after deployment and the low number of reported crashes that occurred in the work zone.

A comparative analysis report and the summary report on SWZ applications were written by FHWA in 2008 that quantified the benefits of ITS applications for work zone traffic management using case studies. The study focused on before and after analyses to quantify the value in mobility and safety when SWZ applications were used (USDOT Federal Highway Administration 2008). Lessons learned were also documented as a result of this effort. Some of the positive outcomes from the installation of SWZs were noted. Michigan saw reductions in aggressive driving maneuvers at work zone lane drops, observing that forced merges were seven times less frequent and dangerous merges were three times less frequent when the SWZ system was operational. Texas and the District of Columbia stated that there were significant traffic diversion rates, 10 percent and 52 percent respectively, and lower observed mainline volumes when appropriate messages were displayed during congested conditions. In Arkansas, 82



percent of the surveyed drivers felt that the SWZ system improved their ability to react to stopped or slowed traffic and 49 percent of the surveyed drivers also noted that the CMS made them feel safer.

The American Traffic Safety Services Association (ATSSA) prepared an overview to aid traffic engineers, transportation agencies, and construction contractors on the ITS tools available to help increase mobility and safety through work zones (American Traffic Safety Services Association n.d.) The document provides a description of typical SWZ system components and their benefits, identifies various traffic detection locations used to collect roadway data, and distinguishes systems that can be used to relay information to road users and workers. In addition, this document gives a general layout of the ITS equipment that should be considered for the various SWZ system components. One example of a general layout provided in the overview is shown in **Figure 1** for a stopped or slowing traffic warning system for a work zone. Multiple other layouts are provided in the document.

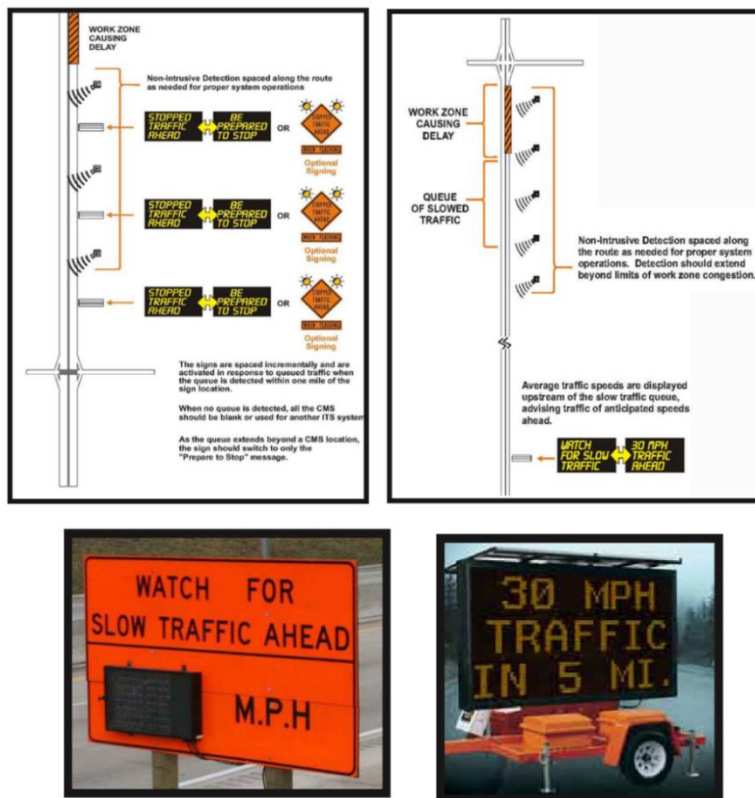

**Figure 1: General Layout for a Typical Stopped or Slowing Traffic Warning (American Traffic Safety Services Association n.d.)**

FHWA developed a Work Zone ITS Implementation Guide in 2014, presented in **Appendix A**, to assist public agencies, design and construction firms, and industry in the design and implementation of ITS in work zones (Ullman, Schroeder and Gopalakrishna 2014). The Guide provides key steps that are required to successfully implement SWZ applications by illustrating how the systems engineering process should be applied to determine the feasibility and design of work zone ITS for a given application. Each key step is defined in each chapter: assessment of needs; concept of development and feasibility; detailed system planning and design; procurement; system deployment; and system operation, maintenance and evaluation. Within the Work Zone ITS Implementation Guide, FHWA drafted a general set of scoring criteria that could be used as one possible method to assess the feasibility of using smart work zone technologies. The appendices of this document are useful and should be reviewed. Some of the key concepts include: National ITS Architecture’s user service requirements that pertain to work zone

management and safety; resources used in the preparation of the Implementation Guide; and key points and tips for consideration at each step in the implementation of SWZ.

To supplement the FHWA Work Zone ITS Implementation Guide, FHWA developed a Work Zone ITS Implementation Tool that serves as a software companion to the Guide. The software is intended for use by agencies in support of independent decision making regarding selection, design, procurement, deployment and evaluation of ITS systems for construction and maintenance projects. The tool comes with a User's Guide. The software and User's Guide can be downloaded from USDOT Federal Highway Administration Explore Application's website: <https://www.itsforge.net/index.php/community/explore-applications#/40/150> The Work Zone ITS Implementation Tool operates as a standalone executable program designed to run on individual workstations. A screen capture of the software download web page is provided in **Appendix A**.

Deeter, Roelofs, Schroeder, and Ullman (2015) suggest that Traffic Management Center (TMC) operations should assist with work zone planning and maintain an active role in the design through work zone operations, including post operation evaluation (Deeter, Roelofs, Schroeder, & Ullman, 2015). Their research provides strategies and recommendations as to TMC resources and how they might be used to support each stage. The table *Work Zone Stages and Strategies for Using Traffic Management Center (TMC) Resources* within the (2015) document gives useful guidance on each work zone stage and the various strategies and sub-strategies. The research proceeds to list specific details of the strategies and examples for each work zone stage and the coordination efforts required to successfully utilize TMC resources. For example, Strategy 1B discusses involving TMC staff in the planning of road work projects from the onset to enable TMC staff to understand the planned projects and impacts for all areas served by the TMC. The authors acknowledge each TMC is unique and resources vary; however, they conclude that there are multiple strategies where functions are common among most TMCs and therefore resources can be used for SWZ applications. The last table *Common Traffic Management Center (TMC) Capabilities and Data Definitions* in the (2015) report lists the TMC capability/data and gives a definition. This information may be a helpful resource available for work zone management. For example, one function of the TMC may be travel time calculation – determining travel times for stretches of highway based on real-time traffic data collection and surveillance. This function may assist SWZ management in determining travel times on a specific corridor prior to a work zone set up. A self-assessment questionnaire was also developed within this research that gives guidance on using the TMC for work zone management. The assessment allows DOTs the ability to assess their TMC's availability and functionality and create an action plan to increase the use of their TMC resources. The self-assessment questionnaire along with the tables from Deeter, Roelofs, Schroeder, and Ullman's (2015) research efforts are included in **Appendix A**.

## 2 - Summarizing Smart Work Zone Efforts on a State Level by ITS Applications

### a. State DOT Smart Work Zone Guides

Many states have evaluated the need for SWZs to improve mobility and safety within construction zones. As such, some state DOTs developed and published smart work zone guides to provide goals and objectives of SWZs, identify acceptable ITS applications for SWZs and help facilitate the successful implementation of SWZs. The SWZ published guides listed below are provided in **Appendix B – State Department of Transportation – SWZ Guidelines**.

### **Connecticut Department of Transportation**

- Smart Work Zone Guide – April 2017

### **Massachusetts Department of Transportation**

- Smart Work Zone Design Standards – February 2016
- Smart Work Zone Standard Operating Procedures – February 2016
- Scoring Criteria for Work Zone ITS

### **Minnesota Department of Transportation**

- IWZ Toolbox: Guideline for Intelligent Work Zone System Selection - 2008
- Decision Tree to Identify Potential ITS/IWZ Scoping Needs – January 2018

### **Texas Department of Transportation**

- Smart Work Zone Guidelines: Design Guidelines for Deployment of Work Zone Intelligent Transportation Systems (ITS) – October 2018
- Go/No Go Decision Tool for SWZ Systems is an excel spreadsheet application and is provided using the link <https://m.txdot.gov/inside-txdot/division/traffic/smart-work-zones.html>

### **Washington State Department of Transportation**

- WSDOT Design Manual Chapter 1010 Work Zone Safety and Mobility – July 2017
- WSDOT Design Manual Chapter 1050 Intelligent Transportation Systems – July 2014

### **Wisconsin Department of Transportation**

- ITS Design and Operations Guide Chapter 40 Smart Work Zones Section 1 Technology, Standards, and Functional Requirements – October 2009

## **b. SWZ Applications**

**Table 2** provides a summary matrix of ITS applications where associated states have implemented SWZ ITS systems coupled with documentation of their results in a case study or research effort. The following sections briefly describe published efforts by state DOTs for the SWZ Applications.

### **1) Queue Warning System**

Queue warning and detection systems estimate the location of the back of the queue and disseminate warning messages to approaching motorists (Li, Martinez-Mori and Work 2016). From 2011 to 2013, Illinois DOT implemented a queue warning system on Interstate 57/Interstate 64 to detect and warn approaching traffic about slow moving or stopped traffic (Ullman and Schroeder 2014). TxDOT in association with Texas A&M Transportation Institute implemented an end of queue warning system as part of a larger SWZ traveler information system to monitor traffic flow, manage mobility, reduce congestion and improve safety (Texas A&M Transportation Institute 2018). TTI research indicates that the portable CMSs provide effective communication to drivers.

### **2) Variable Speed Limit (VSL) System**

Variable speed limit systems intend to increase the volume throughput and enhance safety by providing travelers speed limits determined from the current traffic conditions (Li, Martinez-Mori and Work 2016). Multiple case studies have evaluated the effectiveness and proved to be a viable option to smooth traffic flows around construction zones. Utah Department of Transportation (UDOT) implemented a portable variable speed limit system to reduce regulatory speed limits through construction work zones (VanJura, Haines and Gemperline 2017). The goal of this system was to provide a portable yet dynamic system that was easy for construction personnel to use to reduce



speeds within an active work space and make construction work zone safer for workers and the traveling public, without the need to reduce speeds throughout the entire construction work zone. The system was designed to reduce speeds within the active work space while workers were on-site and exposed to danger of an errant vehicle; however, the speed limits were raised when the workers were not present. In addition, a queue warning system operated independent of the VSL. Alaska DOT also studied the effectiveness of VSL in construction work zones and found that through before and after studies, the portable radar VSL system significantly reduced the 85<sup>th</sup> percentile speed, mean speed, and pace throughout the work zone (Chowdhury and O.A. 2017)

### 3) Dynamic Lane Merge System

Dynamic lane merge systems aim to smooth the flow of traffic through the work zone by regulating merge movements based on traffic conditions (Li, Martinez-Mori and Work 2016). In 2009, Florida DOT evaluated the safety and operational effectiveness of dynamic lane merge for two conditions: early merge and late merge. The research indicates that for volumes ranging from 0-1000 veh/hr dynamic early merge performed better than dynamic late merge. For volumes from 1001-2000 vehicle/hr dynamic late merge performed better than dynamic early merge (Radwan, Harb and Ramasamy 2009). The study also indicated that dynamic lane merge has the potential to enhance safety and traffic operations. In 2004, Michigan DOT deployed a dynamic lane merge system on Interstate 94 to help smooth traffic flow by regulating merging movements in the transition areas where lane configurations narrowed from three to two lanes. The main goals of the project were to reduce aggressive driving at the merge point, maximize available capacity at the merge point just prior to the dropping of a lane, reduce capacity losses due to increase headways at the work zone taper and enhance traveler safety (USDOT Federal Highway Administration 2004) Based on the FHWA case study, Scriba and Luttrell found that the dynamic lane merge system was most effective at peak hour traffic volumes of 3,000 to 3,500 vehicle per hour and increased evening peak travel speeds by 15 percent (Scriba and Luttrell 2007).

### 4) Traffic Data Collection System

With most SWZ applications, data collection is an essential component of the system. SWZ traffic data can be collected and used for real-time applications, applied to further analyses (before and after studies), used for performance measures, and stored for historical information and documentation. Traffic data to be collected may include traffic volumes, speed, occupancy, travel-time and vehicle classification. Depending upon the desired data, different collection devices should be considered. Detection components could include: loop detection, radar, magnetic, piezo-electric, video, microwave, thermal imaging, radio frequency, Bluetooth, WiFi, and probe data.

One research effort undertaken by the Smart Work Zone Deployment Initiative was a study that documented best practices for managing work zone data. The main objective of the project was to investigate methods and best practices that agencies should use to manage work zone data, such as types of data collected, methods used for data collection, data architecture, methods used for geo-referencing data, how work zone data is currently being used and additional data needs (Cheng, Parker and Dong 2017). The researchers found that state DOTs would benefit from a comprehensive work zone data management strategy that would provide a consistent roadmap for development. In addition, the researchers believe that the strategy should cover a standard definition for work zone data elements to facilitate performance reporting and data sharing.

### 5) Travel Time/Delay Monitoring System

This system continuously monitors travel times through a work zone and posts the anticipated travel delay information prior to motorists entering the work zone so that they can make informed decisions about their travel route and select a detour, if desired. In 2000, Ohio Department of Transportation

(ODOT) used a travel time prediction system to post travel delay on CMS at predetermined locations prior to a construction work zone. The system was implemented on I-75 near downtown Dayton and used to determine the accuracy of predicted travel times when compared to actual travel times. The study showed that the travel time prediction system represented a definite improvement over statistic signing (Zwahlen and Russ 2001). The table *Work Zone Deployment*, within the research conducted by Li, Martinez-Mori and Work (2016), lists 12 examples where the main findings were positive and improved traffic operations. The findings were based on operational performance measures and driver survey responses. Of the 12 examples provided in the literature, three examples were shown to produce a 10 percent diversion when drivers were informed of travel times through the work zone (Li, Martinez-Mori and Work 2016).

## 6) Real Time Traveler Information System

A real time traveler information system provides traffic information to motorists, which may include travel time or delay, queue length, reroute information, incidents or site specific construction activities, such as blasting (Li, Martinez-Mori and Work 2016). Therefore, a real time traveler information system could post messages from other SWZ applications or post messages independent of those, such as a full road closure. Both Arkansas and Illinois DOTs implemented portable real time information systems in the early 2000s. Since that time, many other agencies have used this technology to notify drivers of important traveler information. As part of the Smart Work Zone Deployment Initiative, Lachhwani and Horowitz (2005) researched applications of real-time Advanced Traveler Information Systems (ATIS) within work zones in order to improve mobility and safety. Some of the real-time ATIS devices were CMS, highway advisory radio (HAR), CB citizen band broadcasts and speed advisory displays (Lachhwani and Horowitz 2005). Many of the systems showed a reduction in driver frustration, reduced speeding and calm traffic. Some systems even reduced the amount of traffic through the work zone. These effects suggest that work zones are safer when real time traveler information systems are deployed. Benefits of this system include a reduction in rear-end collisions and enhanced congestion management. From December 2013 through March 2014, MassDOT undertook the Callahan Tunnel Rehabilitation Project in Boston. The tunnel lies within a major commuter corridor carrying 30,000 vehicles per day and required a full tunnel closure for the duration of the project (MassDOT 2014). As such, the need for real time traffic condition information was necessary for stakeholders and the motoring public. As a result of this SWZ effort, MassDOT evaluated the effectiveness of the system at minimizing impacts to alternate routes and determined that there were no gridlock conditions in the network and partner agencies were able to successfully manage their systems without major traffic issues caused by the tunnel closure.

## 7) Traffic Monitoring System (video)

This system provides portable cameras and live data streaming to observe real time traffic conditions. This system can be used to view the work site from an offsite location to confirm issues and determine if interventions are required. While traffic monitoring systems are usually incorporated into other SWZ applications, no data was found that shows quantifiable benefits of a traffic monitoring system. In some instances, traffic monitoring systems are used for incident detection. When used in this capacity, incident alerts are confirmed remotely using live streaming video, snapshots or on-site personnel, as discussed within the TxDOT Smart Work Zone Guidelines. This system can also be used to provide critical information to responders and how to best approach the incident.

## 8) Vehicle Entering/Exiting Notification System

This notification system warns drivers of a slow-moving construction or emergency vehicle prior to that vehicle entering or exiting the roadway. The system can be implemented when heavy construction vehicles are required to blend into the traffic stream. While these types of systems are used and documented within work zone applications, a case study was not found that noted the benefits of

installing this type of notification system. However, based on conversations with various states and vendors, an interviewee understood that the Nebraska DOT had experience with a system that flashed a warning sign upstream when a heavy vehicle was exiting the construction site and entering the roadway. Based on discussions, the system seemed to work well in notifying drivers of the slow-moving construction vehicle ahead.

**Table 2: SWZ Application Case Studies**

SWZ Application Type	DOT	Project	Date	Main Findings	Source
Queue Warning System	Texas DOT/TTI	I-35 Expansion Project	2013-2018	Kept drivers apprised of travel delay and typically a part of the overall system to help manage mobility, reduce congestion and improve safety	(Texas A&M Transportation Institute 2018)
Queue Warning System	Illinois DOT	I-70/I-57 and I-57/I-64 interchanges	2011-2013	14% decrease in queuing crashes, 11% reduction in injury crashes	(Ullman and Schroeder 2014)
Variable Speed Limits (VSL)	Utah DOT	4 Construction Zones on State Highways	2016-2018	Increased speed limit compliance by reducing the posted speed limit within active work area when workers are present	(VanJura, Haines and Gemperline 2017)
Variable Speed Limits (VSL)	Alaska DOT	State Highways	2017	Percent of vehicles that sped through WZ was reduced from 21.8% to 9.4% with VSL.	(Chowdhury and O.A. 2017)
Dynamic Lane Merge	Michigan DOT	I-94	2002-2003	Crashes were reduced from 1.2 crashes per month to 0 crashes per month, travel time delay decreased by 16 seconds per driver, average travel speed increased from 40 to 46 mph	(USDOT Federal Highway Administration 2004)

SWZ Application Type	DOT	Project	Date	Main Findings	Source
Dynamic Lane Merge (early merge)	Michigan DOT	I-131 in Kalamazoo	2004	Significant reduction in forced merges when the system was activated. Study team observed three times the number of dangerous merges and seven times the number of forced merges when flashers were off compared to when they were operational.	(USDOT Federal Highway Administration 2008)
Dynamic Lane Merge	Florida DOT	Various locations on Florida State Highways	2009	Data gives thresholds for early and late merge.	(Radwan, Harb and Ramasamy 2009)
Travel Time Monitoring	Ohio DOT	I-17 near Dayton	2000	88% of travel times shown on the CMS were within $\pm 4$ minutes accuracy	(Zwahlen and Russ 2001)
Travel Time Monitoring	North Carolina DOT	I-95	2003	85% of survey respondents changed route in response to CMS travel time display	(Bushman and C. 2005)
Real Time Traveler Information	MassDOT	Callahan Tunnel Rehabilitation Project	2013-2014	No gridlock conditions in the state network or on partner agency networks.	(MassDOT 2014)
Real Time Traveler Information	Illinois DOT	40 miles of I-55	2001-2002	High level of satisfaction; system provided safety benefits due to decreased number of moving violations and small number of crashes within work zone	(USDOT Federal Highway Administration 2004)
Real Time Traveler Information	Arkansas DOT	Various locations on I-30	2000	Workers felt that the ITS application improved their safety	(Li, Martinez-Mori and Work 2016)

SWZ Application Type	DOT	Project	Date	Main Findings	Source
Real Time Traveler Information	North Carolina DOT	I-40 between the NC801 Interchanges and the SR1101 Interchange	2004	Issues with implementation of system which gave inconsistencies in the data	(USDOT Federal Highway Administration 2008)
Real Time Traveler Information	Washington DC DOT	CD-295	2007	Data was inconclusive due to inconsistencies, however, results show the system likely reduced delay for motorists by allowing them to choose an alternate route	(USDOT Federal Highway Administration 2008)
Real Time Traveler Information	California DOT	I-5 in Santa Clarita	2008	78% diversion due to traffic condition	(Edara, Sun and Robertson 2013)

(source: UCG December 2018)

## E. State Departments of Transportation using SWZs

Many state DOTs are utilizing SWZs to inform drivers, improve mobility and enhance safety. The following section gives an in depth review of what these five states are doing to promote SWZ applications.

### 1 - Kansas Department of Transportation (KDOT)

KDOT has implemented SWZ applications that incorporated dynamic lane merge with a queue warning system. Generally, travel times were provided for drivers on CMS prior to the work zone along with 8 CCTV cameras to monitor traffic operations throughout the work zone. Based on an interview with Garry Olson, Transportation Management Plan (TMP) Project Coordinator with KDOT Bureau of Transportation Safety and Technology, the results were favorable with observations made of driver adherence to CMS instructions. Olson stated that KDOT would implement dynamic lane merge in the future when appropriate traffic conditions suggest its need. Olson equates the success to substantial traffic volumes on the roadway, a high portion of commuter traffic, a low percentage of heavy vehicles, and a strong public informational campaign.

This project provided KDOT with some lessons learned. First, the system worked for approximately 7 hours each day based on traffic volumes, and that the hours throughout the day were not consecutive. Next, drivers appeared to be courteous which may have been promoted by the large public outreach about the smart work zone late merge application. Finally, there were many discussions on what data should be retained from the work zone. The data became quite large and was too big for the temporary unit to store. However, speeds and volumes were retained. Based on a before and after comparison, it appeared that about 10% of the traffic diverted away from the work zone during the peak periods.

The total work zone cost for this application included a system integrator at \$5,000 per month. In addition, KDOT rented three radar units at a cost total cost of \$1,500 per month. Deployment efforts totaled \$58,500

and the operation and maintenance totaled \$15,470 for a total SWZ cost of \$99,970 which equates to a daily cost of approximately \$840 a day for the dynamic lane merge with queue warning system (Kansas DOT 2016).

## 2 - Iowa Department of Transportation (IOWADOT)

IOWADOT deploys SWZ applications a bit different than design-bid-build projects, where the traffic control is bid with construction project. Based on interviews, IOWADOT has a statewide smart work zone contract where approximately 30 projects are completed per year. Because Iowa uses TransSuite in their TMC operations, TransSuite is also used to control their smart work zones and they use their own software/algorithms with their SWZ applications to estimate travel time, queue lengths, and such.

IOWADOT deployed a variety of ITS SWZ applications on 28 high traffic work zones on state managed highways (IOWADOT 2018). The ITS components included traffic sensors and cameras that monitored 24/7 and sent data on traffic speeds, queue lengths and images to the TMC. Operators in the TMC then sent messages to the public through portable CMS or their existing DMS, the 511 system and on social media platforms to alert the public of transportation issues that might impact them. In addition, engineers and inspectors were notified through automatic text messages when slowdowns of more than five minutes happened within a work zone. This application allowed IOWADOT to react more quickly to an incident and make modifications to the work zone and keep traffic flowing smoothly and safely. In an interview with Jim Webb, a district construction engineer with IOWADOT, he stated that IOWADOT "...is a big proponent of the use of [SWZ] tools on major projects in southeast Iowa because of the immediate feedback they provide. The information gathered from the devices is essential to respond to and lessen situations. By using real time video feeds, receiving notification of traffic back-ups or other disruptions in the flow of traffic from queue detection units or observe speed trends from the INRIX data, IOWADOT can better manage traffic in the work zone effectively with the ITS tools."

## 3 - Michigan Department of Transportation (MDOT)

MDOT has been implementing smart work zone applications for over 15 years, with some of the first dynamic lane merge systems to reduce aggressive driving. In an interview with Chris Brookes, Work Zone Delivery Engineer with MDOT, Michigan is deploying a combination of smart work zone applications dependent upon the type of construction and work zone needs. Michigan has used portable cameras for monitoring; however, these devices increase the cost of the system. In addition, MDOT has found that the abundance of data increases the cost of detection and in reality, the data is not processed or analyzed after the construction project is completed. One lesson Michigan DOT learned was that CMSs need to be located on both sides of the roadway for the dynamic merge condition. Blocking by heavy vehicles created issues when drivers were notified of stopped traffic ahead but never saw the sign. In addition, Brookes stated that the displayed message is an important aspect of the smart work zone. For example, "watch for back-ups" should never be posted unless there is an active work zone because this type of message can easily become disregarded by motorists if it is posted all of the time.

Brookes stated that to date they have not implemented smart rolling closures. However, there has been some consideration. Portable CMS, detectors and other devices could be leap frogged each night as the active work zone shifts to maintain continuity. Because most dynamic devices update their position every five minutes or less, this application could be seen in the near future. Both iCone and Ver-Mac are two vendors that provide dynamic SWZ components with self-locating devices.

Michigan is beginning to research the benefits of GPS mapped work zone signing. This could allow the work zone set up information to be shared with community-based traffic and navigation apps such as Waze. The system would need to be user input free reliably input the information without depending upon contractors



to map each sign, accurately. Signs that may be mapped include all those that require the driver to know about (ex: begin and end work zone, lane shifts or closures). The signs could then broadcast a message to alert motorists through their cellular phones or other handheld devices automatically through the work zone.

In conclusion, Brookes recommended using the FHWA Implementation Guide Score Sheet and scoring every project to determine the need for ITS components within a work zone. This scoring guide would provide a systematic approach to implementation. This would give a fair and adequate analysis of the need with a scoring system, because MDOT has found that when funding is limited on a construction project, the first aspect of the project to be eliminated is smart work zone components.

#### 4 - Texas Department of Transportation (TxDOT)

TxDOT has been researching SWZ applications with Texas A&M Transportation Institute (TTI) over the past few years to determine their need. As a result, SWZ efforts have been implemented on approximately 10 construction projects throughout the state. Because of the positive results and feedback from motorists, TxDOT developed their SWZ Guide and Go/No-Go Decision Tool. In addition, the Traffic Safety Section, Traffic Engineering Section and the Traffic Management Group are in the process of developing standards sheets that recommend how SWZ applications and components will be set up in the future.

### F. Smart Work Zone Vendors

---

Six smart work zone vendors were contacted to identify available SWZ systems. The following vendors offer equipment, software, and services that conform to the basic features of SWZs. The SWZ system component/application names and descriptions listed within this section are based on the information obtained by each respective vendor. As such, these vendors most likely have the ability to configure their systems to support additional types of SWZ applications that are not listed within this section.

#### 1 - All Traffic Solutions

All Traffic Solutions manufactures portable ITS equipment that can be used in smart work zones for remote management (All Traffic Solutions 2018). Some of their ITS components include portable radar speed signs and speed trailers, portable variable message signs, and vehicle counting/classification systems.

**Radar Speed Displays** – Web-enabled radar speed displays informs drivers that their speed may be excessive. The portable signs can be mounted on a pole, trailer or vehicle.

**Audible Alerts** – Built into the radar speed display, alerts can sound whenever a speeding driver passes the sign to alert the driver to slow down.

**Beacons** – Beacons flash when vehicles exceed the speed limit to alert drivers that they should slow down.

**Variable Message Signs** – Provide drivers with information before they approach a work zone, that can be programmed remotely. These signs can be mounted on a vehicle, trailer or pole.

#### 2 - ASTI Transportation Systems

ASTI Transportation Systems develops, manufactures, and integrates safety products for State DOTs. Their products include message boards, over-height vehicle detection, license plate recognition, portable video surveillance and many other items. ASTI provides smart work zone systems as listed in **Table 3** (Work Area Protection 2018).

**Table 3: ASTI Transportation Systems SWZ Systems**

SWZ System Components	Description
Information Processing System	This computerized highway information processing system (CHIPS), is a patented software/web based system for ITS applications. The system provides a central location to monitor, track and control all ITS field devices. The system features: real-time traffic management, smart work zone systems, automated work zone ITS, dynamic merge solutions and travel time systems
Message Board Trailers	Message board trailers provide real time messages to the traveling public.
Mobile Video Trailers	This trailer provides a portable, self-contained, all weather equipment platform and provides the user with a rapidly deployable real time video system viewable from a remote location.
Trailer Mounted Queue Detection	This trailer provides a versatile and light weight platform with a small footprint to mount a microwave radar unit. If equipped with ASTI's communication package, the trailer can provide data remotely to a variety of information gathering/dissemination components.
Variable Speed Limit Trailers	Can be utilized in both a fixed mounted application or as a portable application to post driver speeds. This trailer can be controlled from a remote location allowing the immediate changing of a posted speed.
Pole Mounted Cameras	This is a portable application for video needs. The system allows the monitoring of traffic conditions
Egress Warning Systems	This is a two trailer system that operates together to notify drivers when slow construction vehicles are entering the roadway with flashing beacons.

(source: ASTI website, current as of November 2018)

### 3 - Wanco, Inc.

Wanco, Inc. manufacturers and sells portable variable message signs, arrow boards and radar speed signs. In addition, Wanco partnered with PDP Smart Work Zone Systems to develop and produce portable hybrid smart work zone components using a variety of detector technologies (radar, Bluetooth, video cameras) to monitor and communicate updates to drivers when hazards or unexpected driving conditions are present. Wanco SWZ system components are included in **Table 4**.

**Table 4: Wanco, Inc SWZ Systems**

SWZ System Applications	Description
Trucks Entering Highway Warning System	Identifies when construction vehicles are leaving a worksite and entering the highway to warn drivers of oncoming vehicles.
Queue Detection and Warning System	Identifies stopped or slowed traffic in real time to warn driver ahead of time.
Travel Time Measurement System	Uses sensors to calculate accurate travel times and dynamic messaging to communicate those times to drivers.
Dynamic Late Merge Systems	Provide drivers with notification of merge decisions to increase roadway capacity near a work zone.



SWZ System Applications	Description
Portable Ramp Metering	Provides ramp metering capabilities for on-ramps that are not yet equipped or need to be maintained during peak traffic flow periods.
Traffic Camera System	Provides remote monitoring of the site and roads so that incidents can be quickly identified and cleared.

(source: Wanco, Inc web site, current as of November 2018)

#### 4 - Street Smart Rental

Street Smart Rental deploys SWZ technologies on large scale construction projects (Smart Street Rental 2018). They specialize in providing smart technology, rental equipment, and project management to enhance work zone safety. The Smart Street technical support team has the ability to assist their clients with deployment, maintenance, and troubleshooting. **Table 5** lists the various types of SMZ components that can be selected to create a customized SWZ.

**Table 5: Smart Street Rental SWZ Systems**

SWZ System Applications	Description
Dynamic Lane Merge	A merge system that notifies drivers of merge conditions. These systems could be considered for deployment as part of the traffic control plan.
Traveler Information Radio	Message broadcasts from transmitters that provide general information to the traveling public.
Temporary Roadway Hazard	System considered for deployment as part of the traffic control plan when there are known hazardous driving conditions such as curve warnings, snow plows ahead, weather conditions, falling rocks, slope movements.
Queue Warning System	Informs drivers of the presence of downstream stop and go traffic conditions.
Alternative Routes	Used with dual travel time panels to show travel time for alternative routes allowing drivers to make a selection as to their route.
Traveler Time Information	Considered for deployment as part of the project's traffic control plan when the work zone will cause delay
Conflict Warning	Used to notify drivers of reduced speeds, trucks entering/exiting or other applications with a portable CMS.
Variable Speed Limit	Should be considered when work zones will cause additional delay.

#### 5 - Ver-Mac

Ver-Mac is a manufacturer of SWZ equipment and teamed with Jamlogic Software to create complete SWZ applications. Ver-Mac has been providing SWZ equipment for over 15 years with over 250 SWZ deployments. The Ver-Mac SWZ equipment includes: portable CMS, portable sensors and cameras, speed-Mac portable sensors, work zone and VSL, speed information feedback signs and additional SWZ devices.

Ver-Mac provides SWZ applications using Jamlogic as shown in **Table 6**.

**Table 6: Ver-Mac SWZ Systems**

SWZ System Applications	Description
Automated Queue Warning	The queue warning is based on real time traffic data that automatically informs travelers of the presence of downstream stop and go traffic with the use of pre-positioned portable CMS.
Travel Time/Alternate Route Suggestion	Travel times are continuously updated to provide current travel time or length of delay to inform motorists and allow them to make informed decisions about their selected route.
Variable Speed Limits	Based on real-time traffic data, Variable Speed Limit systems automatically inform motorists of lower speed limits needed upstream due to slowing traffic or congestion.
Work Zone Speed Limits	Portable work zone speed limit trailers are designed to display work zone speeds when workers are present and posted speed limits when workers are not working or present.
Speed Awareness	Speed awareness devices display the current speed of the motorist along with the posted speed. Feedback messages can be displayed when the motorist exceeds the posted speed limit.
Dynamic Lane Merge	Utilizing portable sensors before a lane reduction, the system analyzes speed and occupancy of each lane before the merge. Based on the traffic flow data, the system will provide real-time lane information to motorists upstream to even the flow of traffic thru the merge.
Over-height Vehicle	Utilizing over-height detection sensors, the system automatically alerts drivers in advance of an alternate route or to stop if they have passed the route.
Hazardous Roadway/Weather Conditions	Utilizing a variety of weather and roadway sensing devices, these systems dynamically caution motorists about dangerous or unexpected roadway conditions.

(source: Ver-Mac web site, current as of November 2018)

## 6 - iCone

iCone is a unique system of individual barrels and pins that collect real time traffic data within work zones. The iCone is either a traffic barrel or a traffic cone with a “pin” inside that locates itself, collects volumes, monitors traffic speed and links to the web, but looks like an ordinary traffic barrel or cone to the public (iCone 2018). These products can provide data on traffic conditions and the system is portable. The iCone system processes information and allows DOTs, contractors and others to obtain information about the work zone conditions. Because iCone barrels act independently, if one barrel is disengaged from the system, the system compensates and continues to operate.

The iCone system can be used for a variety of SWZ concepts. For example, a few iCone traffic barrels or pins could be placed on a detour, when available, which would allow ADOT the ability to monitor alternative routes and instruct motorists of travel times and information on which route to take for proactive detour management based on real time conditions. Using similar techniques other SWZ concepts such as, automated queue warning, variable speed limits near active work zones and dynamic lane merge could be achieved. Reports are available that can provide the location of the end of the queue, travel time through the work zone, speeds and other metrics. iCone can be matched with portable CMS to give real time delay or slowed traffic messages to the approaching traffic.

iCone has written arrangements with principal navigation companies to provide WZ locations and data. Within a couple of minutes of activation, the data is uploaded and pushed to the navigation companies. This allows the navigation companies to more easily convey accurate WZ information to the traveling public who use these various applications to make travel arrangements or navigate while driving.

In addition to traffic barrels and pins, iCone uses their technologies within WZs in different applications. These applications include service vehicles with arrow panels, booms and hazard bar lights and flagging batons. For equipped service vehicles, the iCone system is activated and data is transmitted when a feature is triggered from the vehicle. For example: when the arrow panel is operational, the data transmitted to iCone correlates to the message on the arrow panel. The data is then pushed to the traveling public, using principal navigation systems, and provides real time traveler information on lane restrictions. For flagging batons, when activated, the system transmits the position of the flagger and detects when the paddle is laid down.

## G. SWZ Typical Costs

SWZ systems can be procured as individual bid items for each component or as a lump sum cost. Costs were difficult to obtain from vendor interviews because depending upon the SWZ applications, project location, duration, and length, costs would vary substantially. However, it is important to recognize that system integration is a significant portion of the SWZ applications and should be included in each bid accordingly.

The Texas Department of Transportation (TxDOT) Smart Work Zone Guidelines lists SWZ applications and presents system cost examples from various projects in Texas, Wisconsin, Minnesota and Hawaii. In addition, the SWZ application costs are presented as a percent of the total construction cost. The costs vary greatly of SWZ applications because the costs are dependent upon the length of the work zone and the duration of the construction. As a percent of the total construction cost, SWZ applications varied from 0.07% to 2% as shown in the examples from TxDOT.

In a FHWA Work Zone ITS Overview Webinar that featured ITS work zone experiences in Southern Illinois in 2014, costs associated with four SWZ projects were noted. The costs for the SWZ ranged from \$455,00 to \$2.5 million and varied due to the construction duration and length. These costs varied from 1.4 to 3.6% of the total construction budget, with the average around 2.6% (Nemsky 2017).

In 2014, IOWADOT performed a smarter work zones technology case study that focused on technology applications for SWZs deployed throughout Iowa. As a part of the case study, Iowa published the vendor per-device costs for three ITS SWZ systems. One vendor was selected for all three deployments. **Table 7** lists the costs by device for their SWZ deployments.

**Table 7: IOWADOT Schedule of 2014 Costs per Device (Iowa Department of Transportation 2014)**

SWZ System Component	Cost Item	Contract 1 Western Iowa	Contract 2 Eastern Iowa	Contract 3 Council Bluffs
Portable CMS	Daily Cost (per day)	\$20	\$22	\$23
	Deployment	\$2,600	\$2,900	\$3,200
	Relocation	\$480	\$480	\$480
Traffic Sensor	Daily Cost (per day)	\$18	\$23	\$25
	Deployment	\$2,200	\$2,600	\$2,800
	Relocation	\$480	\$480	\$480

SWZ System Component	Cost Item	Contract 1 Western Iowa	Contract 2 Eastern Iowa	Contract 3 Council Bluffs
CCTV	Daily Cost (per day)	\$20	\$22	\$23
	Deployment	\$2,600	\$2,900	\$3,200
	Relocation	\$480	\$480	\$480
Cell Modem in Traffic Sensor	Daily Cost (per day)	\$4	\$4	\$4
	Deployment	\$300	\$300	\$300
	Relocation	\$500	\$500	\$500

In 2014, Kansas Department of Transportation implemented a smart work zone system that included queue warning, automated variable speed limits, travel times and alternative route detour, as appropriate. The system was deployed on a 1.48 mile stretch of I-35 and the Homestead Lane Interchange, which was rebuilt. KDOT received five bids for the I-35 SWZ with the winning bid of \$1,046,540 (Bledsoe, Raghunathan and Ullman 2014). The smart work zone technology employed on this project did not eliminate any of the costs associated with traditional construction. Additionally, the report concluded that an economic analysis showed the implementation of the SWZ technology resulted in an additional cost of approximately \$1,650,000 and that the majority of the cost was associated with the lease/purchase of portable message system, associated software and upgrades to existing software, and data analysis.

## H. SWZ Communications

Communications within SWZs is an important aspect of each system. As such, different vendors use various types of services to communicate with the field devices and most vendors have the flexibility to support multiple communications options. These communications options include cellular, satellite and radio-based communication services. The selection of which communications option is used is dependent upon the existing wireless network coverage area available at the SWZ application location and the communications requirements such as reliability, latency limits, etc. specified in the departments Standard Specifications or Project Special Provisions.

The vendor interviews indicated that most projects run on cellular services and that the cellular services are reliable. However, it is recommended that the contract documents require that the contractor verify the signal strength of the cellular network within the SWZ location before the cellular communications method is approved for use.

Some vendors also indicated that communications should be based on the SWZ concept that is being performed. For example: Smart Street Rentals recommended using 900mhz radios for queue warning systems due to the quick response time (latency) in sending messages to alter traffic of slow speeds ahead. In an interview with Street Smart Rental, their experience showed that latency for cellular is about 1.5 to 2 minutes, satellite is 2-3 minutes, and 900mhz radio is 1-2 seconds. In addition, for all three types of communications there have been no impacts on the SWZ systems ability to archive data collected for obtaining historic records of traffic data and system alerts. Using a combination of satellite and cellular technologies, iCone representative Ken Smith stated that data latency is within 2 minutes of activation to posting on Extensible Markup Language (XML) feeds.

Communications costs vary depending upon options. The vendors indicated that cellular service is the least expensive. Adding radio systems to the SWZ will increase the cost because the overall SWZ system would most likely run using both cellular and radio communications. For example, communications between field devices would use the radios, but data and/or video sent to remote interested parties or servers would use

the cellular communications network. The greatest communications cost is satellite. This option is recommended by vendors for use in remote areas when cellular services are not available.

A few of the vendors recommended that the state DOTs should have the contract documents require the contractor to provide a system integrator on the project for trouble shooting any communications issues that may arise within a SWZ.

## I. ADOT SWZ Goals

---

ADOT has identified the following SWZ goals for this project:

- Better inform motorists
- Speed compliance
- Improve safety in and around work zones
- Improve mobility
- Know when work zones are active
- Adapting to latest innovations

The following goals were discussed, and it was determined that the associated performance measurers only need to be evaluated during initial deployments:

- Improved work productivity – This will be evaluated for the first few applications as proof of concept, but not applicable long term as a goal to be continually evaluated.
- Customer satisfaction – This may be measured in less customer complaints over time, although more difficult to measure unless through public traveler survey. Contractor satisfaction will be reviewed during the Lessons Learned Workshop after the first deployment of a smart work zone concept and will be documented in the final report.

## J. ADOT SWZ Operational Concepts

---

Using the framework put forth by the FHWA, the Arizona SWZ system will include the following subsystems:

- Traffic data collection and GPS;
- Queue warning system;
- Dynamic lane merge;
- Travel delay/times;
- Traffic monitoring camera system; and
- Variable speed limits.

### 1 - Determining the Need for a SWZ

#### a. Identifying Work Zones that Should be ‘Smart’

Any projects that are determined as “Significant”, per ADOT Work Zone Policy shall have a full Transportation Management Plan for the project. “Significant” in ADOT’s policy is determined by a project’s characteristics and the magnitude and extent of the anticipated work zone impacts. For “Significant” projects, a Temporary Traffic Control plan consistent with the MUTCD, Arizona Supplement to the MUTCD, and ADOT Traffic Control Design Guidelines is required. A Transportation Operations component is required that identifies strategies to mitigate impacts of the work zone on the operation and management of the transportation system: demand management, corridor/network management, safety management, enforcement, and work zone traffic management. A Public Information component is required to inform affected road users, the general

public, area residences and businesses, and appropriate public entities about the project, the expected work zone impacts and the changing conditions of the project. The intent of ADOT's Policy is to maintain flexibility in determining the level of significance (Major or Minor) for all projects added to ADOT's 5-year Construction Program.

A "Significant" project as defined by FHWA is "one that, alone or in combination with other concurrent projects nearby is anticipated to cause sustained work zone impacts (as defined in 630.1004) that are greater than what is considered tolerable based on State policy and/or engineering judgement" and "all Interstate system projects within the boundaries of a designated Transportation Management Area (TMA) that occupy a location for more than three days with either intermittent or continuous lane closures". This covers Interstate segments in higher volume urban areas to be classified as significant projects, while lower volume rural Interstates do not require to be classified as significant projects unless the DOT chooses to implement that criteria.

I-10 between Phoenix and Tucson and I-17 have been identified as "Significant" project corridors where any project associated with these corridors are considered significant projects. For any projects occurring on ADOT roadways other than I-10 or I-17, the following methodology can be used to determine if SWZ application is desired.

The first decision to be made as part of the Arizona SWZ concept is to determine if the work zone itself warrants the use of smart work zone applications. A SWZ system is useful for work zones where compliance is paramount to the safety of workers in the work zone, but a SWZ system is also more costly and requires more resources than a traditional work zone. The first course of action is for ADOT personnel to use judgement, based on their experience with the project location and general TCP impacts on traffic, to determine when or if a smart work zone should be considered for inclusion when considering the following questions:

- Is the work zone going to have a substantial negative impact to traffic?
- Are there existing traffic issues/concerns in the area?

If at least one answer to the above questions is yes, then a work zone is an ideal candidate for expending the additional costs/resources to deploy a smart work zone system.

## **b. Identifying SWZ Subsystems**

When SWZs are applied, there will be traffic data collection devices incorporated into the application of each system type. Data requirements for work zones require that devices or processes be able to collect the following information:

### **FHWA 23 CFR 630.1012d2**

- Number of crashes within the work zone
- Speed
- Travel time through work zone
- Delay
- Queue length
- Traffic volume
- Incident response and clearance criteria
- Work duration criteria



## ADOT Work Zone Policy – Subsection I

- Monitor and measure work zone impacts during construction based on criteria such as travel delay, queue lengths, and crash occurrences.

After the decision is made to pursue a SWZ implementation, the next questions are related to what applications to use. There are many factors that can be considered when deciding whether or not to implement a SWZ application. The many factors that were evaluated include vehicle speeds (high speed versus low speed), roadway type (freeway versus highway), congestion (volume/capacity ratio greater than 1.0 or less than 1.0), traffic volumes (high volume versus low volume), lane restrictions (no lanes or more than one lane), and others.

It was determined, through an evaluation of ADOT roadways and the types of factors that would support engineering judgement in the application of smart work zone technology around the state, that five specific factors should be considered to help identify the relevant subsystems that should be included in the deployment. These factors include and are specifically linked to subsystems that apply when the answer is affirmative:

- **Congestion** – Is the work zone going to cause congestion or a case where the volume to capacity ratio will exceed 1.0?
  - If yes, utilize a **Queue Warning** system.
- **Lane Restriction** – Is the work zone going to be restricting or closing lanes of traffic?
  - If yes, utilize a **Dynamic Merge** system.
- **Delay information** – Is there an alternate route option within 5 miles in advance of the work zone and/or to alleviate drive frustration?
  - If yes, utilize a **Travel Delay** system.
- **Surveillance Capability** – Is there no permanent camera or surveillance capability existing to be able to monitor the work zone?
  - If yes, utilize a **Traffic Monitoring (Camera)** system.
- **Length of Work Zone and Need for Changing Speeds when Workers are Present** – Is the length of the work zone exceeding 2 miles and there is a desire to be able to lower posted speed limits when workers are present?
  - If yes, utilize a **Variable Speed Limit** system.

When SWZs are applied, there will be traffic data collection devices incorporated into the application of each system type that provide robust data source for ADOT to understand real-time conditions in and in advance of the work zone, as well as achieve a historical record of the work zone traffic data. The use of a traveler information system will be generally covered by the use of VMS in the work zone and the sharing of data with the ADOT TOC for use.

Specific SWZ applications such as entering/existing vehicle system, pedestrian applications, or rolling closure should be determined by ADOT personnel on a project-by-project basis but were not included in the ADOT concept for consistent SWZ application.

## 2 - Recommended Technologies









Based on the SWZ subsystems that are included in the Arizona SWZ concept, a set of associated technologies will be required to achieve the subsystem functions and purposes. **Table 8** outlines the required technology components for each subsystem.

**Table 8: Arizona SWZ Technologies**

Subsystem	Associated Technologies						
	CCTV Camera	Sensors	Communications	Solar power	Message sign	Software	Geolocation
Traffic Data Collection and GPS		X	X	X		X	X
Queue Warning		X	X	X	X	X	X
Dynamic Lane Merge			X	X	X	X	X
Travel Delay			X	X	X	X	X
Traffic Monitoring	X		X	X		X	X
Variable Speed Limits		X	X	X	X	X	X

The following subsections describe each subsystem in additional detail regarding the technologies used as well as conceptualized placement of the technologies to collect the data to determine success in achieving the goals and objectives of the SWZ. Characteristics and functionalities for each subsystem are bulleted in advance of graphics showing the layout of technologies in relation to the work zone. Below is the legend of icons represented in the subsections for each system.

**Legend**

 Portable Variable Message Sign (PVMS)	 Portable Trailer Location	 Location of Active Work Space as Defined by RE
 Portable Variable Speed Limit (PVSL) Sign	 Traffic Detection Zone	 Traffic Control for Work Zone
	 CCTV Camera	 Global Positioning System (GPS) Device



### a. Traffic Data Collection and GPS

- FMS traffic detectors and/or private sector data will work great in the urban areas of the state but may not be feasible/reliable in rural areas.
- Forward fire radar traffic data collection technology mounted to portable device trailers is typically used for SWZ and may be required when implementing other advanced SWZ applications.
- Desire to have a traffic detection location within 50 feet past the posted speed limit reduction sign to capture the entering work zone vehicle speed data.
- Desire to have a traffic detection location in the middle of the work zone to track speed compliance within the work zone.
- Need to know if traffic is creating queue length longer than 20 minutes as determined by length of queuing typically experienced by RE.
  - This equates to ¼ mile detector location upstream of first work zone cone lane taper, then 1 mile back, then 1 mile back – this will cover 2.25 miles of potential queuing.
- Need a GPS/traffic data collector point at the end of the work zone at the point the lane restriction terminates.
- Need GPS location information on the first SWZ device trailer, such as a portable VMS or detection device trailer.
- GPS location information does not need to be hyper-precise.

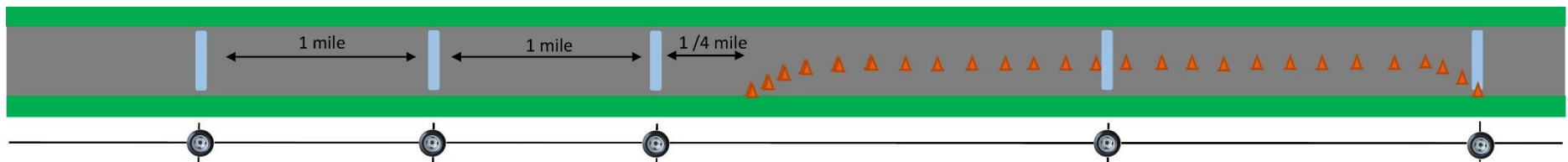

Figure 2: Traffic Data Collection and GPS – Technology Concept Layout

## b. Queue Warning

- Do not use this scenario during urban daytime operations.
- If you have a curvy roadway, guidance should state to use more detection and VMS locations.
- 2-4 mile queuing is where ADOT would be concerned and will work to remedy the situation.
- 4-6+ mile queuing is where ADOT would be very concerned and will work to remedy the situation immediately.
- Distance between first VMS and second VMS is variable but deployed on a 1-mile increment. The distance from the work zone to the first VMS is based on project in one-mile options (1, 2, 3, etc.) based on the discretion of the RE.
- First data collector point  $\frac{1}{4}$  mile upstream of first work zone cone lane taper, then variable distance to first VMS with one detector location placed in between first data collector point and first VMS.
- One data collector point in between each VMS location upstream of work zone.
- VMS should be deployed on both sides of the travel way under two conditions: 1) when there are 3 or more travel lanes for the same direction of traffic provided refuge space is available or 2) when work zone is on routes with high truck volumes (>15% of traffic is trucks) regardless of the number of lanes.

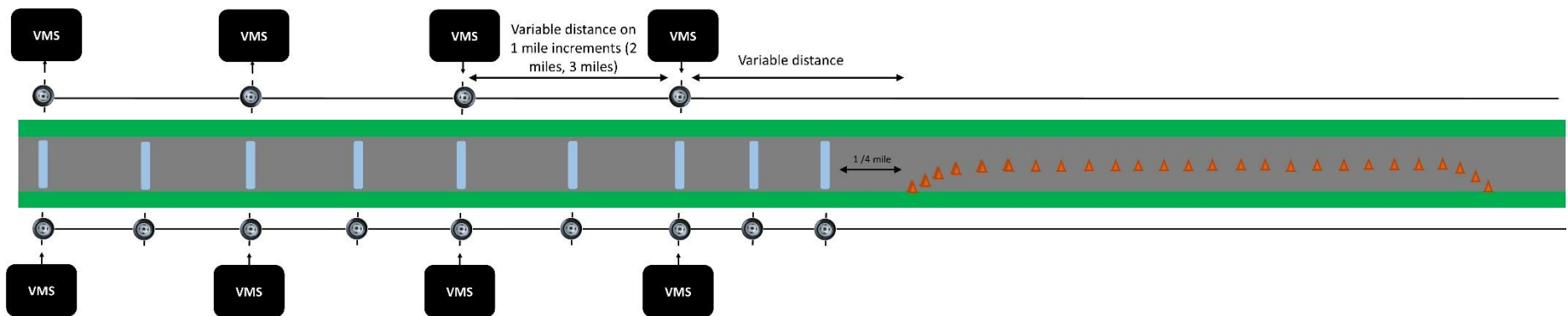

Figure 3: Queue Warning – Technology Concept Layout

### c. Dynamic Lane Merge

- This concept supports early or late merge scenarios.
- VMS at lane taper point will always be needed.
- Any VMS upstream of taper point can say USE BOTH LANES or MERGE OVER signage to support either late or early merge scenarios.
  - Early merge scenario: Low traffic volume and free flow average speed.
  - Late merge scenario: Moderate to heavy traffic volume and lower than free flow average speed.
  - Volume threshold to transition from early merge to late merge application: >1500 vehicles per hour per open lane or if a queue is detected.
  - Speed threshold to transition from early merge to late merge application: when average speed of the vehicles is less than  $\frac{3}{4}$  of the normal average speed.
- VMS should be deployed on both sides of the travel way when there are 3 or more travel lanes for the same direction of traffic.

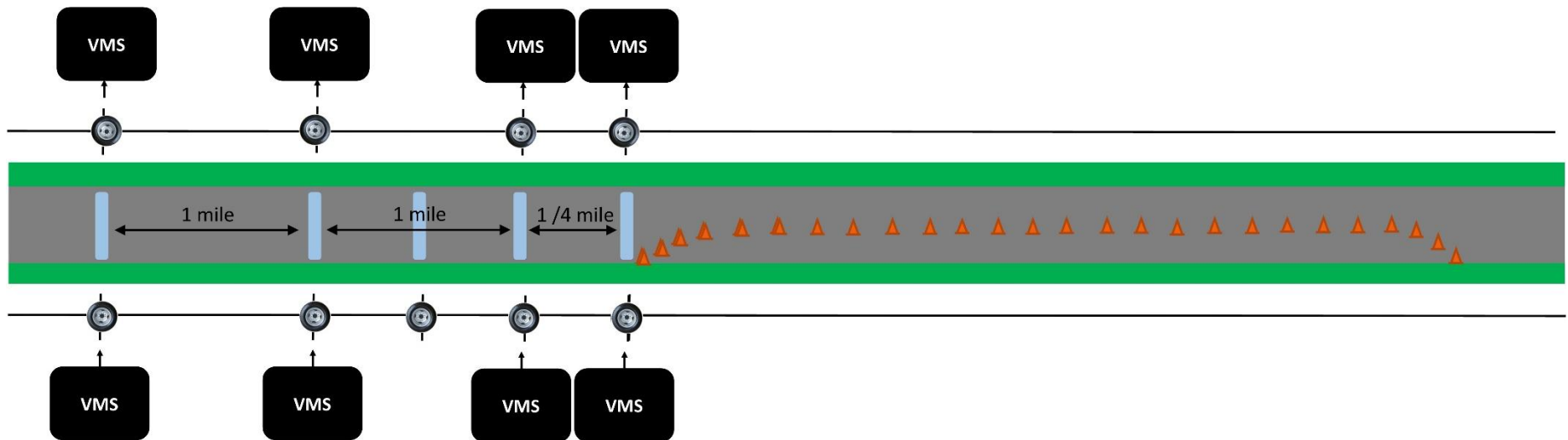

Figure 4: Dynamic Lane Merge – Technology Concept Layout

#### d. Travel Delay

- Do not use this application during urban/congested/high volume conditions.
- This application would be good along with queue warning.
- The type of technology to use to collect travel delay will be the decision of the contractor as the specification will focus on the functional requirements of the system to allow for adapting technology. The type of technology applied should be accurate within 5 minutes of ground-truth tested travel delay upon initial deployment verification.
- The VMS location in front of an alternate route location is good to have but needs to be determined on a project by project basis only if the alternate route is available within 5 miles of the work zone location. Any distance beyond 5 miles, ADOT permanent message signs will likely be able to provide that advanced message.
- No particular distance in front of work zone was desired for the first VMS location upstream of the work zone, although beyond 5 miles may be challenging for the contractor to include within a work zone traffic control deployment.
- The information collected by this application should be provided to ADOT for processing and display on the AZ511 system.
- VMS should be deployed on both sides of the travel way when there are 3 or more travel lanes for the same direction of traffic.

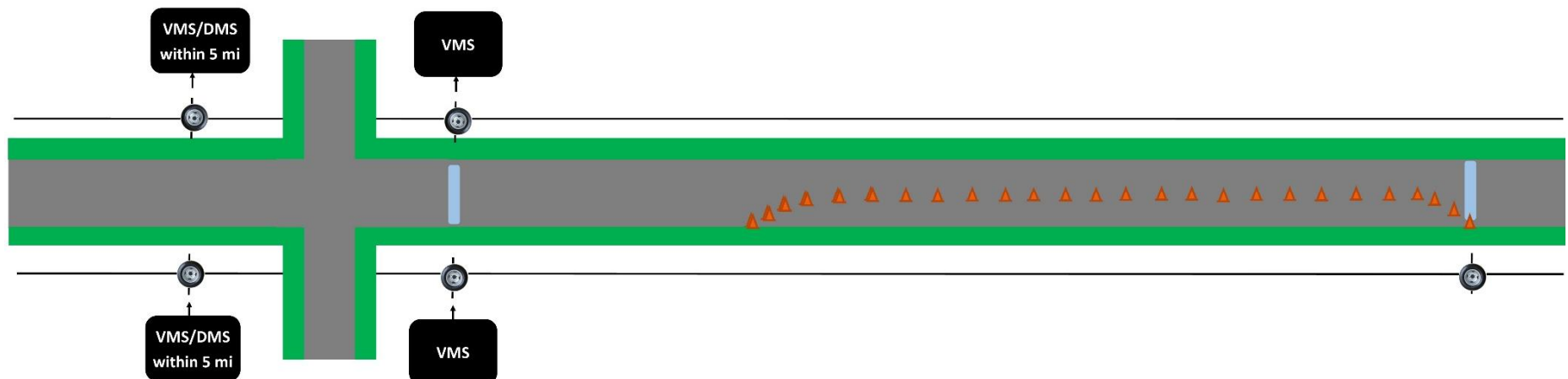

Figure 5: Travel Delay – Technology Concept Layout

### e. Traffic Monitoring (Camera)

- This system is desired if there are no permanent surveillance options in the area.
- Deploy on traffic signals if possible in work zone area.
- Desire the location of the surveillance to be at the beginning of the taper captured by either a pan/tilt/zoom camera or two cameras pointed in opposite directions mounted on one trailer.

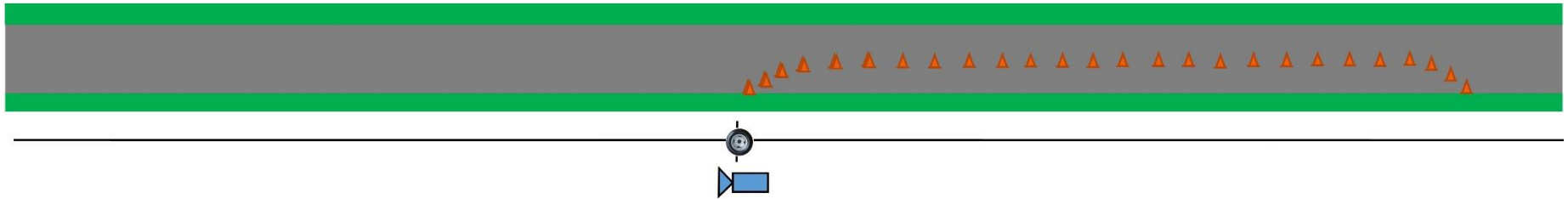

Figure 6: Traffic Monitoring – Technology Concept Layout

## f. Variable Speed Limits

- Variable speed limits should be considered on work zones longer than three miles with no physical barrier.
- Variable speed limits should be considered on work zones that have frequent periods of time when workers are not present:
  - Typical weekly work schedule doesn't include weekends,
  - Typical weekly work schedule doesn't include nighttime work, or
  - Typical weekly work schedule doesn't include daytime work.
- ADOT desires the placement of multiple VSL within the work zone, as opposed to frequent VSL movements to "Active Work Space" areas where the majority of workers are physically present and actively performing work duties within the work zone..
- Place VSL every 1 mile.
- ADOT desires VSL in advance of the work zone to help with speed harmonization in combination with queue warning to slow traffic down in advance of queues forming. These distances will need to be consistent with the distances chosen for queue warning which is "distance between first VMS and second VMS is variable but deployed on a 1-mile spacing and the distance from the work zone to the first VMS is variable depending on the type of queue anticipated and the curviness of the roadway."

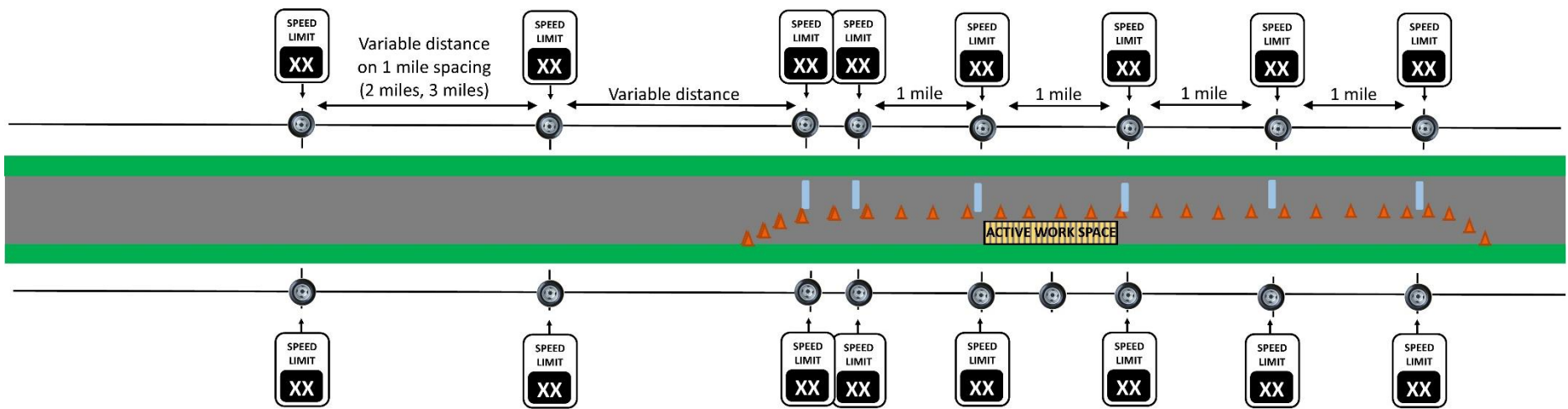

Figure 7: Variable Speed Limits – Technology Concept Layout

### 3 - Subsystem Integration Opportunities

The data and outputs from SWZ deployment strategies can be used to obtain better information about real-time and historical work zone conditions, such as delays and closures. By integrating the SWZ subsystems with existing ADOT systems and/or providing the TOC operators access to the SWZ system, the data and information from the SWZ system can be collected and disseminated more efficiently and then be used to support informed decision making, both from ADOT and the traveling public. Existing systems at the TOC include:

- **Highway Condition Reporting System (HCRS)** – central database for real-time roadway restriction information from work zones, incidents, and special events. Entries into HCRS populate the AZ511.gov website, which provides comprehensive and real-time motorist information for the state of Arizona.
- **Variable message central system (Camera Cameleon [DCAM])** – used to manage variable message signs (VMS) to provide in-route, real-time information to travelers about roadway and operational conditions. These types of VMS are also commonly referred to as dynamic message signs (DMS) and changeable message signs (CMS).
- **Closed-circuit camera television (CCTV) central system (Camera Cameleon [CamCam])** – central system where real-time camera feeds from CCTVs are collected and made viewable by TOC operators, the public, and the media.
- **(Future) Connected Vehicle Infrastructure central management** – ADOT is deploying dedicated short-range communications (DSRC) technology to support vehicle-to-infrastructure (V2I) communications, such as the broadcast of basic safety messages alerting vehicles of upcoming safety hazards on the roadway.

### K. Performance Measures

As part of the SWZ system development process, performance measures are recommended in the context of overall goals and objectives for the project. It is anticipated as part of this project to evaluate the first deployments of these SWZ concepts using the performance metrics summarized in **Table 9** as applicable to each goal and objective for Arizona SWZ systems.

The performance of the selected SWZ deployment strategies need to be evaluated, by working with the WZ stakeholders (i.e., the State, general contractors, TTC subcontractors, and SWZ vendors), to refine these strategies for optimum effectiveness and efficiency.

**Table 9: Arizona SWZ Proposed Performance Metrics**

Goal	Objective	Proposed Metric
Better inform motorists	Improved traveler information	Travel times/delay * Number of messages provided by SWZ (unique messages could be speeds, travel times, queue messages, etc.)
	Know when work zones are active	Number of work zones using SWZ
Speed compliance	Improved speed compliance in work zone	Speed variation Speed compliance when workers are present

Goal	Objective	Proposed Metric
Improve safety in and around work zones	Safer for traveling public and workers	Number of crashes * Queue length * Reduce speed limits when workers are present Traveler compliance with posted speed limits
Improve mobility	Posted speed limits coordinated with worker activity	Reduced length (distance) and/or time lower speed limits are posted
Adapting to latest innovations	Ability to be flexible with advances in SWZ technology	Performance specification flexible to new technologies

\* Metrics specifically cited in ADOT's Work Zone Policy

ADOT will need to establish a baseline of “before” data for which to compare the “after” data once the system has been implemented. ADOT should potentially consider phasing the implementation of the system on a given project, in order to test the “active” versus “not active” individual subsystems. An example would be to establish three different data points such as: 1) lay down detection with no other subsystems in place, 2) then to place technologies related to all subsystems applied to that work zone without turning them on, 3) then to activate only one subsystem, all while the normal construction activities remain consistent from one phase to another, and 4) then turn off that first subsystem while the next subsystem is activated.

## L. References

- All Traffic Solutions. *Work Zone Safety*. 2018. <https://www.alltrafficsolutions.com/solutions/work-zone-safety/>.
- American Traffic Safety Services Association. *Improving Travel Through America's Work Zones*. American Traffic Safety Services Association, n.d.
- Bledsoe, Jay, Deepak Raghunathan, and Jerry Ullman. *Kansas Demonstration Project: Improvements to the Homestead Lane/I-35 Interchange in Johnson County*. Final Report, Washington DC: USDOT Federal Highway Administration, 2014.
- Bushman, R., and Berthelot C. *Response of North Carolina Motorists to a Smart Work Zone System*. Washington DC: Transportation Research Board 84th Meeting, 2005.
- Cheng, Yang, Steven Parker, and Shuoxuan Dong. *Best Practices for Managing Work Zone Data*. Final Report, IOWADOT: Smart Work Sone Deployment Initiative, 2017.
- Chowdhury, Tanay, and Abaza O.A. *Effectiveness of VSL Signs in Reducing Crash Rates on Roadway Consturciton Work Zones in Alaska*. Conference Paper, New York City: 19th International Conference on Traffic Guidance and Transportation, 2017.



- Deeter, Dean, Tina Roelofs, Jeremy Schroeder, and Gerald Ullman. *Guidance on Using Traffic Management Centers for Work Zone Management*. DTFH61-12-D-00046, Washington DC: USDOT Federal Highway Administration, 2015.
- Edara, Praveen, Carlos Sun, and Andrew Robertson. *Effectiveness of Work Zone Intelligent Transportation Systems*. Final Report, Midwest Smart Work Zone Deployment Initiative, 2013.
- iCone. *The Instant ITS System*. 2018. [http://iconeproducts.com/?page\\_id=55](http://iconeproducts.com/?page_id=55).
- Iowa Department of Transportation. *Smarter Work Zones Technology Applications*. Case Study, Washington DC: USDOT Federal Highway Administration Every Day Counts, 2014.
- IOWADOT. *Transportation Matters for Iowa: Iowa Work Zones Are Getting Smarter*. June 25, 2018. [https://www.transportationmatters.iowadot.gov/2018/06/iowa-work-zones-are-getting-smarter.html?utm\\_medium=email&utm\\_source=govdelivery](https://www.transportationmatters.iowadot.gov/2018/06/iowa-work-zones-are-getting-smarter.html?utm_medium=email&utm_source=govdelivery).
- Kansas DOT. *Dynamic Late Lane Merge System*. Final Project Evaluation, Kansas DOT, 2016.
- Lachhwani, Vikas, and Alan Horowitz. *Criteria for Portable ATIS in Work Zones*. Milwaukee: Smart Work Zone Deployment Initiative, 2005.
- Li, Yanning, Juan Carlos Martinez-Mori, and Daniel Work. *Improving the Effectiveness of Smart Work Zone Technologies*. ICT-16-023, Springfield: Illinois Department of Transportation (SPR), 2016.
- Massachusetts Department of Transportation. *Smart Work Zone Design Standards*. Standards, Massachusetts Department of Transportation, 2016.
- MassDOT. *Smarter Work Zones Technology Applications Case Study: Technology Applications on the Callahan Tunnel Project*. 2014. <https://tti.tamu.edu/featured-project/facilitating-deployment-decisions-of-highly-portable-end-of-queue-warning-systems/>.
- Nemsky, Ted. *USDOT Federal Highway Administration Workzone Mobility and Safety Program Work Zone ITS Overview Webinar January 30, 2014*. February 2017. <https://tti.tamu.edu/featured-project/facilitating-deployment-decisions-of-highly-portable-end-of-queue-warning-systems/>.
- Pant, Prahlad. *US Department of Transportation Federal Highway Administration Mobility and Safety Program*. February 5, 2017. [https://ops.fhwa.dot.gov/wz/workshops/accessible/Pant\\_paper.htm](https://ops.fhwa.dot.gov/wz/workshops/accessible/Pant_paper.htm).
- Paracha, Jawad, and Rachel Ostroff. "Improving Work Zones Every Day, in Every Way." *Public Roads*, Summer 2018: Volume 82 No. 2.
- Radwan, Essam, Rami Harb, and Shankar Ramasamy. *Evaluation of Safety and Operational Effectiveness of Dynamic Lane Merge System in Florida*. Final Report, Tallahassee: Florida Department of Transportation, 2009.
- Scriba, Tracy, and Jennifer Atkinson. "Creating Smarter Work Zones." *Public Roads*, March/April 2014: Vol 77 No 5.

- Scriba, Tracy, and Tim Luttrell. *ITS in Work Zones: Dynamic Lane Merge System*. Case Study, Washington DC: USDOT Federal Highway Administration, 2007.
- Smart Street Rental. *Smart Work Zones*. November 19, 2018. <https://www.streetsmartrental.com/smart-work-zones.html>.
- Texas A&M Transportation Institute. *Facilitating Deployment Decisions of Highly Portable End-of-Queue Warning Systems*. 2018. <https://tti.tamu.edu/featured-project/facilitating-deployment-decisions-of-highly-portable-end-of-queue-warning-systems/>.
- Ullman, Gerald, and Jeremy Schroeder. *Mitigating Work Zone Safety and Mobility Challenges Through Intelligent Transportation Systems*. Case Studies, Washington DC: USDOT Federal Highway Administration, 2014.
- Ullman, Gerald, Jeremy Schroeder, and Deepak Gopalakrishna. *Work Zone Intelligent Transportation Systems Implementation Guide*. Washington DC: US Department of Transportation Federal Highway Administration, 2014.
- USDOT Federal Highway Administration. *Benefits of Using Intelligent Transportation Systems in Work Zones*. Summary Report, Washington DC: US Department of Transportation Federal Highway Administration, 2008.
- . *Ceter of Accelerating Innovation Smarter Work Zones*. September 8, 2017. <https://www.fhwa.dot.gov/innovation/everydaycounts/edc-3/swz.cfm> (accessed November 22, 2018).
- USDOT Federal Highway Administration. *Intelligent Transportation Systems in Work Zones: A Cross Cutting Study*. FHWA-OP-02-025, Washington DC: USDOT, 2002.
- USDOT Federal Highway Administration. *ITS in Work Zones: Using an Automated Traffic Information System to Reduce Congestion and Improve Safety During Reconstruction of the I-55 Lake Springfield Bridge in Illinois*. Case Study, Washington DC: USDOT Federal Highway Administration, 2004.
- USDOT Federal Highway Administration. *ITS in Work Zones: Dynamic Lane Merge, Reducing Agressive Driving and Optimizing Throughput at Work Zone Merges in Michigan*. Case Study, Washington DC: Federal Highway Administration, 2004.
- USDOT Federal Highway Administration. *ITS in Work Zones: Keeping Traffic Moving During Reconstruction of the Big I*. Case Study, Washington DC: USDOT Federal Highway Administration, 2004.
- USDOT Federal Highway Administration. *ITS in Work Zones: Reducing Agressive Driving and Optimizing Throughput at Work Zone Merges in Michigan*. Case Study, Washington DC: USDOT Federal Highway Administration, 2004.
- USDOT Federal Highway Administration. *ITS in Work Zones: Reducing Congesiton with the Use of a Traffic Managment Contract Incentive During hte Reconstruction of Arizona SR68*. Case Study, Washington DC: USDOT Federal Highway Administration, 2004.

VanJura, Josh, David Haines, and Andrew Gemperline. *Use of Portable and Dynamic Variable Speed Limits in Construction Zones*. Washington DC: Transportation Research Board 2018 Annual Meeting, 2017.

Work Area Protection. *Smart Work Zone Systems*. 2018. <https://workareaprotection.com/smart-work-zone-systems/>.

Zwahlen, Helmut, and Andrew Russ. *Evaluation of the Accuracy of a Real-Time Travel Time Prediction System in a Freeway Constructin Work Zone*. Paper No. 02-2371, Washington DC: Transportation Research Board, 2001.

# Appendix A

## FHWA SWZ Documentation

Creating Smarter Work Zones by Tracy Scriba and Jennifer Atkinson, March/April 2014.  
<https://www.fhwa.dot.gov/publications/publicroads/14marapr/06.cfm>

- [ARTICLES](#)

- **DEPARTMENTS**

- [Editor's Notes](#)
- [Along the Road](#)
- [Internet Watch](#)
- [Training Update](#)
- [Communication Product Updates](#)

## Creating Smarter Work Zones

*by Tracy Scriba and Jennifer Atkinson*

*Advances in high-tech tools mean improved safety and efficiency during roadwork.*



Texas A&M Transportation Institute

**The Texas Department of Transportation deployed this portable message sign as part of an end-of-queue warning system used during a construction project on I-35. This system is one of many technologies that State and local highway agencies can use to improve safety and mobility in work zones.**

Have you ever approached a work zone on a highway and found yourself in a backup that made you late for an appointment? Or driven through a work zone at night and found it challenging to navigate? Or traveled through a construction area wondering how workers stay focused with traffic driving right by their “offices?” If you drive regularly, you have likely experienced one or more of these scenarios and perhaps considered the impact that work zones have on congestion and safety.

These areas are estimated to cause 10 percent of all congestion and 21 percent of the less predictable kind of congestion that varies from day to day and makes travel times for trips unreliable. Significant congestion in urban areas can result from closing lanes during the day for roadwork, which may cause unacceptable delays to road users and businesses. This issue has led some local jurisdictions to enact policies to specify that all work on major roads must be done at night.

The conflict exists because traffic and roadwork are using the same space. A large portion of highway construction is repairing and improving existing roads. In 2008, 80.5 percent of highway capital expenditures were allocated to system rehabilitation (51.1 percent), expansion of existing roads (17.4 percent), and enhancement (12 percent) of those roads. For system rehabilitation, that amounts to about \$40.4 billion.

Safety implications result from traffic and roadwork occurring in such close proximity. In 2010, more than 87,600 crashes occurred in work zones, resulting in 576 deaths and almost 26,300 injuries. More than 20,000 workers are injured in work zones each year, with 12 percent of those due to traffic incidents. Challenges to work zone safety and mobility are also exacerbated by the growing issue of distracted driving.

Roadway work zones are necessary to maintain the transportation network for mobility, safety, and productivity, so eliminating roadwork is not an option. However, various technological tools are available to help transportation professionals effectively plan for, implement, and manage work zones on all types of roadways. Technological advances in work zone safety and efficiency, in combination with other strategies, help to address specific needs while keeping workers and the traveling public safer.

### **Technological Solutions**

The transportation community can use technology to identify and assist in remediating work zone issues. Technologies can detect and help mitigate queues, manage speeds, reduce worker exposure, gather performance data, identify and facilitate responding to incidents quickly, inform road users of traffic conditions, improve the visibility of traffic controls in work zones, improve road user and worker safety, and inform future work zone strategies.

The use of technology, including intelligent transportation systems (ITS), in work zones is one of many possible strategies that agencies can incorporate into their transportation management plans (TMPs). A TMP, as required by the Federal Work Zone Safety and Mobility Rule, lays out a set of strategies for work zone management--traffic control, public information and outreach, and transportation operations--that an agency will use to manage the impacts of a particular road project. Considering whether to deploy technology/ITS on a project and designing and deploying a system should be done as part of the impacts assessment for a work zone and the development and implementation of a TMP.





**ITS applications for use in work zones, such as this smartphone app that shows realtime messages on roadway signage, can help motorists plan ahead and make more informed decisions prior to trips.**

“The success stories of technology use to mitigate work zone impacts continue to mount nationally, to the point that the traveling public is now beginning to expect and even demand it,” says Gerald Ullman, senior research engineer at the Texas A&M Transportation Institute. “I believe that those agencies and contractors who learn how to best incorporate work zone technology into their decisionmaking processes and ways of doing business will be the most successful and profitable in the future.”

### **History and Evolution**

Technology has made work zones safer, more efficient, and “smarter.” Historically, logging work zone data meant using a clipboard while watching queues onsite. Now, agencies use transportation management centers to monitor traffic; ITS to collect data and identify issues such as queues; and other technologies to relay information to motorists, manage speeds, and perform basic work zone duties.

Technological solutions once were limited to a single purpose and operated independently. For example, speed feedback signs detected the speeds of approaching vehicles and displayed those speeds to encourage motorists to slow down. Agencies did not collect this data or feed it into a larger system to monitor work zone operations or assess performance. Although speed feedback signs are still a useful, low-cost solution in some work zones, agencies now can integrate solutions over multiple platforms to

analyze data and provide travelers and work zone practitioners with the knowledge they need to make informed decisions.

Another significant change when using technology in work zones is the availability of data collected by vendors. Agencies increasingly have the option to lease or purchase traffic data from companies that collect it via Bluetooth® and other technologies. This option enables agencies to leverage the technology already deployed by others and obtain useful information and capabilities without having to deploy and maintain their own sets of devices. For example, the Ohio Department of Transportation (ODOT) purchases historic and realtime speed data to monitor traffic flow, including that in work zones. One way ODOT uses the data is to plot travel speeds in work zones against historic travel speeds to identify significant delay issues to further explore in the field. “Use of this data vastly expands ODOT’s ability to monitor its work zones in a cost-effective manner,” says Dave Holstein, administrator of ODOT’s Office of Traffic Operations. “We can quickly identify issues and take steps to address them.”

Technology in work zones has typically included applying ITS solutions to create “smart work zones” or “smartzones.” Smart work zones are defined as those that use ITS to manage work zone traffic and operations. Agencies use sensors, communications, software, and electronic equipment to collect and analyze traffic flow and road conditions in real time and to provide updated, accurate information and guidance to drivers. The primary goal of a smart work zone is to improve mobility while enhancing safety for both motorists and highway workers.

Traditionally, ITS technologies were a means to provide accurate, realtime information to road users so they could make informed choices. Drivers who are knowledgeable about hazards, delays, and what actions they should take improve the safety of a work zone and reduce congestion. Today, agencies have additional uses for technology in work zones. For example, an agency can use technology to provide data for performance management and to automate some aspects of the setup of traffic controls, reducing or even eliminating the amount of time that workers are exposed to traffic.

Several common themes related to work zone issues--managing speeds and queues, reducing exposure, preventing incidents, gathering performance data and managing traffic, identifying incidents, managing traffic at nighttime, and providing traveler information--are benefitting from recent advances in technology. These advancements will help inform future work zone strategies and provide technologies that can be refined for future use.

<b>Work Zone Technologies</b>			
<b>Technology</b>	<b>Description</b>	<b>Work Zone Issue Addressed</b>	<b>Potential Benefits and Outcomes</b>
<i><b>Managing Speeds</b></i>			
Automated Speed Enforcement	Mobile units used in automated speed enforcement record when a vehicle’s speed exceeds a specified maximum and document the date and time of the violation. The mobile units are equipped with onboard cameras that capture images of the vehicle’s license plate and possibly the driver.	<ul style="list-style-type: none"> <li>Crashes associated with speed and involving road workers</li> <li>Speeding in work zones</li> <li>Speed differentials</li> </ul>	<ul style="list-style-type: none"> <li>May significantly reduce fatal and severe crashes</li> <li>Increases speed limit compliance and may reduce average speeds</li> </ul>
Speed	Speed feedback signs inform	<ul style="list-style-type: none"> <li>Speeding in work</li> </ul>	<ul style="list-style-type: none"> <li>Can be moved to</li> </ul>

Feedback Signs	approaching drivers of their current speeds and encourage them to slow down if they are traveling above the speed limit. The signs typically are portable and can be installed upstream of the work zone or within the work area when driver speed compliance is an issue.	zones	<p>new locations as needed</p> <ul style="list-style-type: none"> <li>• Require minimal maintenance</li> <li>• Encourage drivers to comply with the posted speed limit</li> </ul>
----------------	--	-------	---

**Reducing Exposure**

Automated System to Install Raised Pavement Markers	Automated placement of raised pavement markers reduces the need for personnel and vehicles for manual installation, while minimizing exposure to workers. A typical placement operation includes four vehicles and a six-person crew, but the Georgia Department of Transportation's automated system requires one vehicle and only two staffers.	<ul style="list-style-type: none"> <li>• Worker exposure during installation of pavement markers</li> </ul>	<ul style="list-style-type: none"> <li>• Reduces worker and road user exposure and increases safety</li> <li>• Reduces the need for multiple fleet vehicles to a single-vehicle operation</li> <li>• Lessens the wear and tear on vehicles associated with stop-and-go operations</li> <li>• Improves the installation rate versus traditional methods</li> </ul>
---	---	---	---

Automated Cone Deployment System	An automated machine for deployment places and retrieves traffic cones during roadway lane closures. This system can be operated by a single worker to open and close busy lanes for construction or maintenance work zones.	<ul style="list-style-type: none"> <li>• Worker exposure during setup and removal of traffic cones</li> </ul>	<ul style="list-style-type: none"> <li>• Reduces worker and road user exposure</li> <li>• Can be operated by a single worker</li> </ul>
----------------------------------	--	---	---

Moveable and Mobile Barriers	This technology allows quick barrier adjustments to create protected work spaces or to reallocate travel lanes in a work zone to match fluctuations in traffic flow. Unlike traditional barriers, which are difficult and time consuming to reposition, movable and mobile barriers	<ul style="list-style-type: none"> <li>• Worker safety, particularly on highways with high speeds</li> <li>• Number, duration, and impact of needed lane closures</li> </ul>	<ul style="list-style-type: none"> <li>• Can be moved to accommodate peak traffic flow</li> <li>• Provide positive protection in situations where a barrier might not otherwise be used</li> </ul>
------------------------------	---	--	--

	are designed to be quickly moved as a unit.		<ul style="list-style-type: none"> <li>• Can improve worker safety and efficiency</li> </ul>
Remotely Operated Lane Closure System	Installing temporary traffic control devices requires significant resources. And, as a work area changes, the locations of the temporary traffic control devices must also change, which requires personnel to enter the active roadway. A lane closure system that is remotely operated can reduce the interruption to traffic by deploying the temporary traffic control devices needed for lane closures one time and by modifying the setup from a remote location.	<ul style="list-style-type: none"> <li>• Workers in close proximity to traffic</li> <li>• Worker and traffic exposure as vehicle fleets set up signing packages</li> <li>• Impact on traffic flows associated with the installation and removal of signing</li> </ul>	<ul style="list-style-type: none"> <li>• Can be easily installed and relocated</li> <li>• Is operated remotely</li> <li>• Uses solar power</li> <li>• Decreases the downtime associated with multiple installations of signing, which may increase the time available for construction</li> </ul>
Work Space Intrusion Warning	A work space intrusion system alerts workers when a vehicle has entered the area closed for roadwork. The system also alerts the driver.	<ul style="list-style-type: none"> <li>• Vehicles inadvertently entering the work area</li> </ul>	<ul style="list-style-type: none"> <li>• Reduces the potential for vehicle collisions with construction equipment</li> <li>• Increases construction worker safety</li> </ul>
Automated Flagger Assistance Device	Automated flagger assistance devices are mechanically operated devices that function under the same operational principles as traditional flagging. Crews can operate the devices from a distance, which removes human flaggers from close proximity to traffic.	<ul style="list-style-type: none"> <li>• Flaggers being exposed to traffic hazards</li> </ul>	<ul style="list-style-type: none"> <li>• Increases the safety of flaggers by removing them from the traffic lane or shoulder</li> </ul>
<b>Monitoring Performance and Management</b>			
Portable Traffic Monitoring Devices	These devices use radar, cellular, microwave, and satellite technologies to monitor traffic conditions without a large investment of infrastructure or staff resources. The devices can detect queues and measure	<ul style="list-style-type: none"> <li>• Traffic condition data in work zones to monitor and assess performance, provide traveler</li> </ul>	<ul style="list-style-type: none"> <li>• Maximize resources by enabling easy relocation when areas experiencing issues change</li> <li>• Support policy</li> </ul>

	<p>the average travel speed in key areas, such as in advance of and within work zone transition areas. They also store data for analysis purposes.</p>	<p>information, and manage traffic</p>	<p>decisions</p> <ul style="list-style-type: none"> <li>• Have data warehousing capabilities</li> <li>• Can facilitate data collection in locations where permanent collection devices are disabled or not feasible</li> </ul>
--	--	--	--

**Identifying and Preventing Incidents**

<p>Notification of Construction Equipment Entering and Exiting the Traffic Stream</p>	<p>Detection technologies help to identify construction equipment entering or exiting the work area and notify motorists by changing message signage to provide an alert.</p>	<ul style="list-style-type: none"> <li>• Vehicle collisions with construction equipment entering or exiting the traffic stream</li> <li>• Vehicles inadvertently following construction equipment into the work area</li> </ul>	<ul style="list-style-type: none"> <li>• Reduces vehicle collisions with construction equipment</li> <li>• Increases safety of construction workers</li> </ul>
---	---	---	--

<p>Identifying Traffic Incidents Through Traffic Monitoring and Invehicle GPS</p>	<p>An agency can detect when incidents have occurred by monitoring travel speeds or ITS camera images. Technologies that are primarily GPS-based and located within vehicles, such as airbag activation detection, motion sensors, navigation/GPS receivers, and other in-car control devices, provide sufficient information for identifying general traffic patterns. Such realtime information may be able to infer the occurrence of a crash. These capabilities will increase as connected vehicle technology becomes more widely deployed.</p>	<ul style="list-style-type: none"> <li>• Delayed incident detection leading to congestion, queuing, and secondary incidents</li> </ul>	<ul style="list-style-type: none"> <li>• May improve emergency detection and response times to the incident location</li> <li>• May enable more appropriate response equipment to be sent because of camera images</li> <li>• Reduces the likelihood of secondary crashes</li> <li>• Improves travel times through work zones</li> <li>• May be able to</li> </ul>
---	--	--	--

			provide immediate incident notification through automated alerts
<b>Managing Traffic</b>			
Use of Sequential Warning Lights to Improve Recognition of Nighttime Traffic Control	Nighttime lane closures for work zones require motorists to shift into another lane despite reduced visibility. Sequential warning lights affixed on temporarily deployed cones or barrels at the work zone taper can improve driver recognition of the lane closure by clearly delineating the lane taper area.	<ul style="list-style-type: none"> <li>Crashes and queuing resulting from delayed driver recognition of traffic patterns in work zones at night</li> </ul>	<ul style="list-style-type: none"> <li>Increases safety in nighttime work zones by clearly defining lane taper</li> <li>Increases early merging</li> <li>Can reduce average speeds</li> </ul>
Dynamic Lane Merge	<p>Dynamic lane merge is the broad term used to describe several types of merges that agencies can use at lane closure and merge locations. The system may include traffic sensors, trailers with solar-powered flashers, equipment and batteries, dynamic message signs, and communication devices. Types of merges include the following.</p> <ul style="list-style-type: none"> <li>Lane-based signal merge: A strategy that employs a signal at the proper merging point to assign the right-of-way for traffic in each lane if the approaching volume exceeds 800 vehicles per hour per lane.</li> <li>Dynamic early merge: When traffic congestion is low, signs encourage early merging to the through lane to avoid traffic disruptions from</li> </ul>	<ul style="list-style-type: none"> <li>Queuing associated with lane drop</li> <li>Aggressive driving at the merge point and associated crashes</li> <li>Delay associated with incident response at the merge point and congestion through the work zone</li> <li>Right-of-way confusion</li> </ul>	<ul style="list-style-type: none"> <li>Improves road user safety by reducing the number of aggressive merges</li> <li>Improves travel times through the work zone associated with normalized speeds and minimizes queuing</li> <li>Lane-based signal merge increases vehicle throughput and, as a result, reduces the average vehicle delay, stopped vehicle delay, and the number of vehicle stops under congested traffic conditions</li> </ul>

	<p>merges at the lane drop.</p> <ul style="list-style-type: none"> <li>• Dynamic late merge: When traffic congestion is moderate to high, signs encourage using all lanes to the merge point to reduce queue lengths.</li> </ul>		
--	--	--	--

**Providing Traveler Information**

Dynamic Stopped Traffic Advisory	<p>Because queue lengths can vary greatly, identifying a suitable location for advanced warning signage is sometimes difficult without regularly altering the placement. The dynamic stopped traffic advisory system can be activated only when queues exist for determined lengths or sections of roadway, which may help to reduce travel times, decrease work zone congestion, and reduce the likelihood of back-of-queue crashes. The system also can be used to warn motorists about stopped traffic in situations where sight distance is impeded by roadway geometry, such as near horizontal or vertical curves.</p>	<ul style="list-style-type: none"> <li>• Back-of-queue crashes related to little or no warning about queuing</li> </ul>	<ul style="list-style-type: none"> <li>• Collects realtime or near-realtime traffic data</li> <li>• Provides motorists with information about queues and delays</li> <li>• Reduces rear-end crashes</li> </ul>
----------------------------------	--	---	--

Over-Dimension Warning	<p>Work zones may cause temporary minimal width or height clearances for large vehicles using the roadway. Efforts made on behalf of the transportation agency to reroute the affected vehicles may not be effective, so over-dimension warnings give compliance notifications as large vehicles approach the work zone.</p>	<ul style="list-style-type: none"> <li>• Congestion and traffic mobility</li> <li>• Safety</li> </ul>	<ul style="list-style-type: none"> <li>• Alerts drivers that their vehicle is over dimension and they need to use an alternate or escape route</li> <li>• Warns drivers about their inability to continue through the work zone, providing sufficient time to use an alternate or escape</li> </ul>
------------------------	--	---	---



			<p>route</p> <ul style="list-style-type: none"> <li>• Tells drivers to stop when they fail to use the designated alternate or escape route</li> </ul>
Portable Changeable Message Signs	Portable changeable message signs are useful in situations that require advance notice, such as ramp or lane closures, narrow lanes, changing geometric conditions, or realtime travel information.	<ul style="list-style-type: none"> <li>• Significant queuing and delays</li> <li>• Changing travel conditions within the work zone</li> <li>• Work zone speed variability</li> <li>• Changes in roadway alignment and surface conditions</li> </ul>	<ul style="list-style-type: none"> <li>• Provide travelers with realtime information on work zone conditions</li> <li>• Reduce speed variance</li> <li>• Increase effectiveness at night and during inclement weather</li> </ul>
Work Zone Realtime Information System	Portable queue detectors include video cameras mounted on poles in advance of work zones. System detectors collect lane occupancy and traffic speed data and send them to a computer connected to changeable message signage. The computer processes the data and, when it determines that backups are forming, it automatically displays warning messages on the changeable message signage.	<ul style="list-style-type: none"> <li>• Variability in travel time leading to traveler uncertainty</li> <li>• Potential for increased delay</li> </ul>	<ul style="list-style-type: none"> <li>• Reduces congestion associated with lane closures</li> <li>• Reduces rear-end crashes and fatal crashes due to excessive queuing</li> <li>• Improves communication with the motoring public</li> <li>• Provides realtime, credible information resulting in better compliance with suggested actions for travelers</li> </ul>



**This van is equipped with technology to detect and record vehicle speeds through work zones automatically. Mounted cameras take photographs of a speeding vehicle's license plate and driver.**

## **Managing Speeds**

The use of technology for speed enforcement in work zones has the potential to increase compliance and improve the safety of road users and workers. Excessive speeding in work zones contributes to increased frequency and severity of crashes. In addition, the speed differentials between vehicles before and after they enter work zones may be a contributing factor to crashes. Therefore, increasing motorists' compliance with speed limits has the potential to decrease the speed variance and improve safety. This technology application can take several forms.

*Technology-assisted speed enforcement* employs technology such as radar or LIDAR (Light Detection And Ranging) to indicate a motorist's speed, or uses speed-over-distance systems that photograph vehicles at both start and end points to determine whether an infraction has occurred based on the calculated average speed.

*Fixed-camera speed enforcement* uses an automated fixed-camera unit that detects and collects data on speed violators, such as speed, date, time, location, and license plate information, and sends a ticket to the vehicle owner--all without human interaction.

*Mobile speed photo enforcement* may be deployed in vehicles or as freestanding roadside units with oversight typically administered by a law enforcement officer.

In 2006, the Illinois Department of Transportation (IDOT) began using speed photo enforcement as a means to reduce fatalities and severe injuries in work zones. When speed photo enforcement is deployed in a work zone, a sign informs drivers that the system is in use. The Illinois State Police and IDOT, in conjunction with a private vendor, deploy self-contained vans outfitted with this technology. The vans log an approaching vehicle's speed and record when that speed exceeds a specified maximum. The vans are equipped with two onboard cameras: One captures an image of the driver's face, while the other acquires an image of the vehicle's rear license plate. The system also documents the date and time of the violation.

Mobile speed photo enforcement in Illinois is effective in reducing average speeds and increasing compliance with speed limits in work zones. The percentage of vehicles exceeding the speed limit near speed photo enforcement decreased from about 40 percent to 8 percent for passenger vehicles and from 17 percent to 4 percent for heavy vehicles such as trucks transporting commercial goods. Illinois found that average speeds in work zones were reduced by 3 to 8 miles per hour with speed photo enforcement.

An evaluation of speed enforcement technology in the United Kingdom showed that vehicles exceeding the speed limit were reduced at both fixed-camera sites (71 percent) and mobile-camera sites (24 percent). Speed-over-distance systems, a form of technology-assisted speed enforcement, can reduce speed by more than 12 miles (20 kilometers) per hour and lessen associated crashes.

IDOT also has experience with the use of radar speed trailers with speed feedback signs. Radar speed trailers may be supplemented with enforcement to achieve speed reductions over extended periods of time. "IDOT's Bureau of Safety began requiring the use of radar speed trailers in the 2013 construction season on the entry to all of our interstate work zones," says Ted Nemsy, engineer of construction with IDOT District 8. "We have noticed the traffic is slowing down when we use these units."

<b>Production Rates for Traditional and Automated Deployment of Raised Pavement Markers</b>				
	<b>Production Rates</b>		<b>Exposure (Per 12 hours of installation)</b>	<b>Locations of Use</b>
	<b>Two-Lane Roads</b>	<b>Four- (or More) Lane Roads</b>		
<b>Traditional Replacement</b>	750–1,500 markers per day	1,200–2,200 markers per day	72 person-hours	Widespread
<b>Automated Replacement</b>	Unknown	2,100 markers per day	24 person-hours	California, Georgia, North Carolina

### **Reducing Exposure**

Two of the most common devices to delineate work zones, raised pavement markers and traffic cones, have two commonalities: their installation requires considerable manual effort and necessitates that workers deploy the devices very near lanes of moving traffic.



Gary Meek, Georgia Tech

**GDOT uses this machine, developed by the Georgia Tech Research Institute, to install raised pavement markers automatically.**

Manual placement of raised pavement markers exposes personnel to hazards and requires extensive labor hours and fleet needs. Workers typically are separated from highway traffic by only a few inches. A standard placement operation includes a six-person crew and four vehicles consisting of lead and following trucks and operations vehicles.

The Georgia Department of Transportation (GDOT) and Georgia Tech Research Institute have teamed up to develop a way to lessen the personnel and fleet needs associated with manual installation of raised pavement markers, while reducing worker exposure to traffic. Their automated placement system reduces the personnel needed to two--a vehicle driver and an operator to load the markers and adhesive into the installation device.



Source: Minnesota Intelligent Work Zone Toolbox, 2008 Edition.

**MnDOT deploys a nonintrusive technology in some work**

**zones to detect trucks entering mainline traffic from a haul road and uses changeable and static message signs to alert motorists to prepare for trucks entering the traffic flow.**

GDOT uses the automated system on multilane highways to limit worker and equipment exposure. Other advantages to the automated system include the following:

- Changes a stop-and-go stationary operation to a continuously moving operation.
- Reduces the need for multiple fleet vehicles to a single-vehicle operation.
- Increases installation efficiency, minimizes wear and tear on the fleet, and improves the fuel mileage required by the installation process.
- Improves safety by removing one or more laborers from exposure to live traffic.
- Reduces the likelihood of workers suffering burns related to the hot bitumen adhesive used in marker placement.

Similar to the installation of raised pavement markers, manually deploying traffic cones requires workers to be in close proximity to moving traffic for setup and removal. Crews can use an automated traffic cone machine in any work zone that requires traffic cones, especially those covering a significant distance. A single operator can safely and quickly open and close lanes. The system uses just one vehicle to lay down cones automatically at regular intervals and then pick them up again later. The system also can retrieve cones that have been knocked over when hit by vehicles.

### **Preventing Incidents**

Construction contractors can employ vehicle-activated detection to warn travelers about a potential conflict or the need to slow down because of equipment entering or exiting the mainline. As construction vehicles approach a detection system, installed at locations of work area ingress or egress, in-vehicle sensors communicate with a system installed at the perimeter of the work zone. The detection of construction equipment triggers changeable message signs or static signage along the roadway to display warning messages to mainline motorists.

The Minnesota Department of Transportation (MnDOT) uses nonintrusive detection to notify motorists about construction equipment entering or leaving work zones. MnDOT considers applying this technology in three specific scenarios. In the first scenario, construction equipment must use the mainline roadway to accelerate upon leaving the work area. In another scenario, the average daily traffic count on the mainline roadway is so high that drivers of construction equipment cannot easily recognize a gap in traffic to safely enter, or construction equipment crosses traffic at a location with limited visibility. A third scenario is when construction equipment must use the mainline roadway to decelerate and the roadway volume is above the level where traffic can safely adjust speed or change lanes. In each scenario, MnDOT uses the detection and messaging system to reduce the probability of vehicle collisions with construction equipment and provide for increased safety of construction workers. MnDOT also uses the technology to caution drivers not to follow construction vehicles into the work area.

### **Gathering Performance Data and Managing Traffic**

Recent advances in traffic-monitoring technologies, battery power, and communications make it possible to more easily gather realtime data on traffic conditions around work zones. Agencies can use portable traffic-monitoring devices employing radar, cellular, microwave, and satellite technologies to monitor traffic conditions actively without a large investment of infrastructure or staff resources. Portable traffic-

monitoring devices can detect queues and measure average travel speeds in key areas, such as in advance of and within transition areas for work zones. The devices also can store data for later analysis.

The California Department of Transportation (Caltrans) and the California Highway Patrol have discussed using portable traffic-monitoring devices to collect average speeds through work zones in order to assess key times for targeted speed enforcement. If the devices show average speeds that are consistently above the posted speed limits within work zones, the California Highway Patrol could deploy officers to enforce the speed limit.

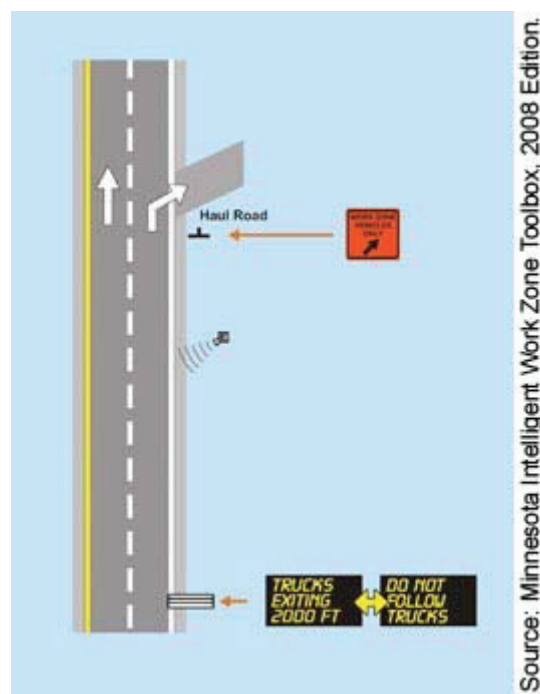

**To discourage drivers from following construction vehicles into the work zone, MnDOT's system displays messages alerting motorists that trucks will be exiting the roadway ahead and reminding them not to follow the trucks.**

A U.S. Department of Transportation report, *Final Evaluation Report: North Carolina Deployment of Portable Traffic-Monitoring Devices*, notes that in many work zones, the investment required to install and maintain full-scale temporary ITS equipment may be cost-prohibitive because of the ever-changing nature of road conditions and traffic. According to the report, traffic-monitoring devices that are permanently installed might be disabled during construction, or temporary traffic lanes might shift vehicles outside the devices' detection area during construction activities. Portable traffic-monitoring devices eliminate these issues because they are highly mobile and relatively inexpensive. Crews can easily move these devices to new locations as needed and deploy more of them when traffic conditions dictate (for example, when queues are longer than expected). Typically, procuring portable traffic-monitoring devices requires a short lead time, and because they are easy to deploy and relocate, they minimize exposure of workers to traffic. These features increase the feasibility of data collection and traffic management in more work zones.

### **Managing Traffic At Nighttime**



Nighttime lane closures for work zones require motorists to shift into another lane under conditions of reduced visibility. However, sequential warning lights affixed on temporarily deployed cones or barrels at the work zone can improve driver recognition of the lane closure by clearly delineating the lane taper.

Using wireless communication, warning lights give the impression of a single light source traveling along the defined taper limits in the same direction as motorists are traveling. A 2011 study on this application, *Cost-Benefit Analysis of Sequential Warning Lights in Nighttime Work Zone Tapers*, performed by the University of Missouri indicates a positive change of nearly 12 percentage points in the number of vehicles that merged early, indicating early recognition of the work zone taper.

Other benefits of sequential warning lights include helping to maximize traffic flow by better delineating the merge area and potentially reducing work zone crashes associated with merging at lane closures and queuing, increasing safety for both road users and workers. In addition, sequential warning lights are a low-cost improvement. Each light costs approximately \$100 (only slightly more costly than conventional warning lights) and has a battery life of more than 1,000 hours.

### Providing Traveler Information

End-of-queue crashes are a concern in work zones where congestion tends to develop, particularly when queuing is unexpected. This type of crash is often severe because it usually involves a large speed differential between the approaching vehicles and the stopped traffic. In congested conditions, any crash is likely to increase traffic backups and lead to more crashes. However, technology such as queue warning systems can effectively reduce end-of-queue crashes.

According to MnDOT's *Guideline for Intelligent Work Zone System Selection*, technologies for dynamic advisories for stopped traffic have the ability to address several issues associated with work zones. For example, queue lengths may vary greatly, even hour-by-hour, making it difficult to predict suitable locations for advance warning signage for temporary traffic control. Queue lengths also may encroach upstream beyond a motorist's reasonable expectations for stopped traffic, and geometrics may cause poor visibility of end-of-traffic queues, shortening reaction times and causing panic stopping. In addition, queues initiated on crossroads may cause traffic conflicts and delays on mainline highways (for example, backups that go beyond the length of ramps and through or around turns at intersections). The MnDOT report cites the system's benefits as including reduction in rear-end crashes, increased diversion of traffic to alternate routes, and ample time for motorists to respond safely.



**A sensor housed within this orange barrel is part of an**



## **end-of-queue warning system that can help prevent crashes in work zones.**

A queue warning system uses detection components paired with variable or dynamic message signs, or static signing with interactive flashers. Crews deploy the detection devices upstream of the work zone at successive intervals where they anticipate queues. Each detection device communicates with its own set of sign components, either activating prepopulated messages such as “Stopped Traffic Ahead/Be Prepared to Stop” or “Speed Ahead 30 MPH/Prepare to Stop,” or activating flashers on the static signing that might read “Be Prepared to Stop When Flashing.”

Because queue lengths can vary greatly, placing static warning signs is challenging. With a dynamic advisory system, messaging changes based on traffic speed and queue length. The system also can warn motorists about stopped traffic in situations where sight distance is impeded by roadway geometry, such as near horizontal or vertical curves.

“The Texas Department of Transportation [TxDOT] is using several types of technology to make the many work zones in the central Texas portion of I–35 safer and easier for travelers,” says Bobby Littlefield, Waco district engineer with TxDOT. “Systems that provide realtime monitoring of current conditions, estimates of future conditions, and localized advance warning of queues caused by lane closures have all been implemented to help travelers plan their trips and safely reach their destinations. In addition to the benefits for travelers and workers, the system is providing a wealth of data for performance monitoring.”

Using technology for queue detection and warning can be particularly effective when queues are unpredictable and therefore unexpected by drivers. When it is difficult to predict when and where queues will occur, it can be challenging and costly to use manual methods, such as to have sufficient staff available to cover extended time periods, and to keep the warning device (enforcement vehicle or truck-mounted dynamic message sign) in the proper location relative to the end of the queue.

In an analysis of a queue detection and warning system implemented at several work zones by IDOT, crash statistics from 2010 (prior to system implementation) and 2011 (after system implementation) showed nearly a 14-percent decrease in queuing crashes and an 11-percent reduction in injury crashes. These reductions occurred despite a 52-percent increase in the number of days when temporary lane closures were implemented.

### **Challenges and Tips to Deploying Technology**

Practitioners deploying these systems have sometimes encountered challenges, such as the cost of deployment, which can limit their consideration, or can result in elimination from the project late in the design phase. As in other areas of technology, practitioners may have difficulty staying abreast of current technologies, especially if their primary expertise is design or construction. ITS staff members often do not interact with construction staff, leading to reduced understanding of work zone issues by those with the technology expertise. Similarly, design and construction staff may have limited awareness of what technology is available, a reluctance to use technology or ITS, or difficulty in using it effectively.

Further complicating these decisions is the wide range of options available, as well as barriers to choosing the most appropriate and effective applications. For example, some new products have limited performance records. And, although others may have been deployed, varying conditions make it tough to estimate performance under different work zone conditions with many variables. A lack of clear goals for using technology on a project can hinder decisionmaking and decrease the likelihood that the selected technology will meet expectations.

These challenges, however, are not insurmountable. By clearly identifying project impacts and potential issues, practitioners can develop management strategies (technology or otherwise) for work zones that

will address those needs. Using a structured process, such as systems engineering, helps to define needs and develop specifications. This type of approach and tips for how to apply it are described in a recent publication from the Federal Highway Administration (FHWA) called *Work Zone Intelligent Transportation Systems Implementation Guide* (FHWA-HOP-14-008). When deciding whether to use technology, practitioners should consider expected impacts, duration of the work zone, performance goals, and the availability of existing equipment. Like other tools for managing traffic in work zones, technology should be used as part of an integrated set of strategies in a TMP.

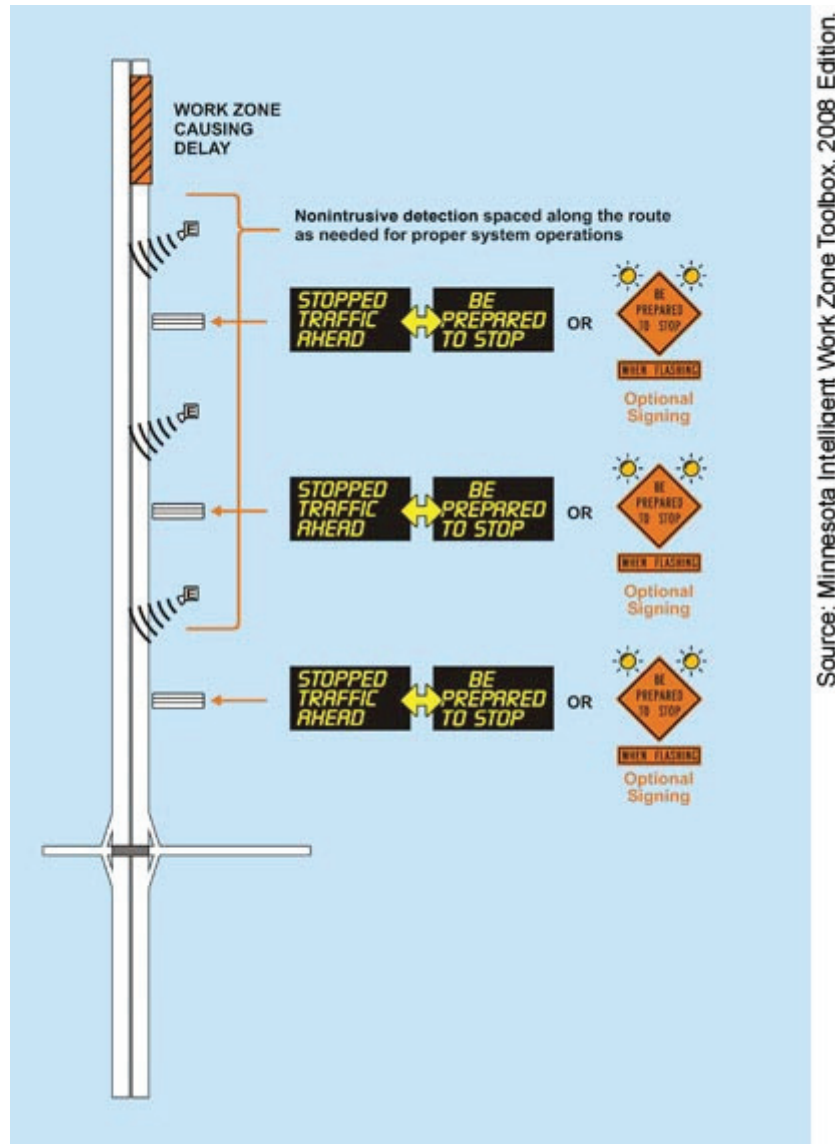

Source: Minnesota Intelligent Work Zone Toolbox, 2008 Edition.

**MnDOT uses this stopped traffic advisory system to alert motorists when work zone-induced delay downstream is a significant concern. Changeable message signs activate in response to traffic when a queue is detected within 1 mile (1.6 kilometers) of the sign's location.**

To help guide its decisionmaking, IDOT is establishing a policy for the use of different types of smart work zone systems. “One of our key lessons learned was that we need to develop a tiered statewide contract special provision for ITS that will allow for competition between all smart work zone systems and establish

a policy to guide where we want to use these different types of systems,” IDOT’s Nemsy says. “In the past, it’s been decided on a project-by-project basis based on [our] knowledge of the project area, traffic incident data, and sight distance issues. We also do queuing analysis for all interstate projects. We are envisioning having three different tiers in our policy and special provisions to recommend different types of smart work zone technology based on factors such as whether a project is on an urban or rural interstate and what level of delays are anticipated.”

In addition, when considering whether to lease or buy technology, practitioners should examine factors such as the planned amount of use; how quickly the technology is likely to change; maintenance needs and expertise of staff; cost; and whether the equipment, if procured, could be permanently deployed.

Communication among design and construction staff and ITS staff within an agency can help with effectively planning, designing, procuring, and deploying technology. Practitioners also can benefit from the knowledge and experiences of their peers when making decisions about technology in work zones. FHWA sponsored a peer exchange in May 2013 to facilitate discussion on the use of technology in work zones. The findings from the peer exchange, as well as recent case studies describing States’ experiences using technology in work zones, are available on FHWA’s work zone Web site at [www.ops.fhwa.dot.gov/wz/its/index.htm](http://www.ops.fhwa.dot.gov/wz/its/index.htm).

---

**Tracy Scriba** is the Strategic Highway Research Program 2 (SHRP2) program coordinator in FHWA’s Office of Operations. She is the former program manager of FHWA’s Work Zone Management Program, where she led many aspects of FHWA’s research, policy, and technology transfer related to work zones. She holds a B.S. in systems engineering from the University of Virginia.

**Jennifer Atkinson, P.E.**, is a senior transportation engineer for Leidos with more than 13 years of public and private sector experience in transportation design, traffic operations, highway safety, and work zone mobility and safety.

*For more information, visit [www.ops.fhwa.dot.gov/wz/its/index.htm](http://www.ops.fhwa.dot.gov/wz/its/index.htm) or contact Tracy Scriba at [tracy.scriba@dot.gov](mailto:tracy.scriba@dot.gov) or 202-366-0855.*

Improving Work Zones Every Day, in Every Way by Jawad Paracha and Rachel Ostroff, 2018.  
<https://www.fhwa.dot.gov/publications/publicroads/18summer/01.cfm>

- [ARTICLES](#)

- **DEPARTMENTS**

- [Editor's Notes](#)
- [Innovation Corner](#)
- [Along the Road](#)
- [Internet Watch](#)
- [Training Update](#)
- [Communication Product Updates](#)

## Improving Work Zones Every Day, in Every Way

*by Jawad Paracha and Rachel Ostroff*

*FHWA has developed a comprehensive set of programs, strategies, and tools for the management of safer and more efficient temporary traffic control.*

Texas A&M Transportation Institute

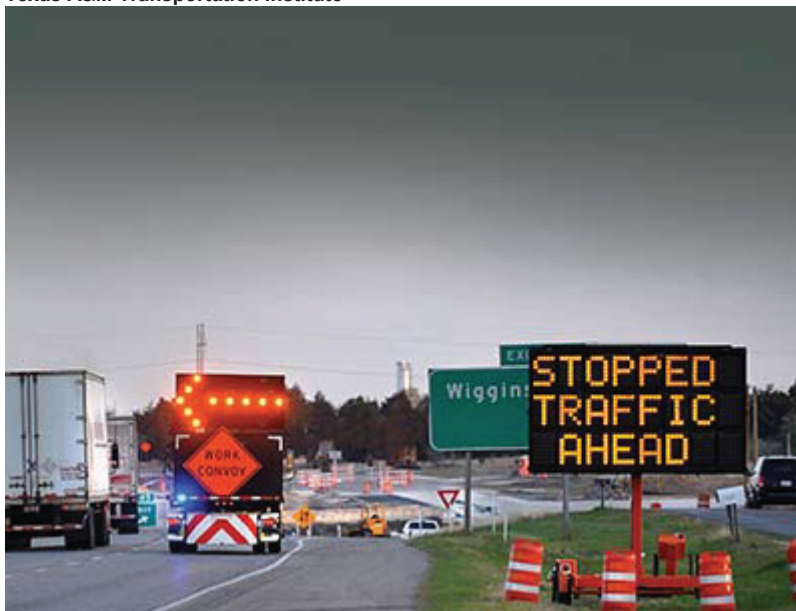

FHWA is helping transportation agencies better manage work zones to minimize delays and incidents.

The addition of work zones on busy roadways is a formula for crashes and increased congestion. In 2015, more than 96,000 crashes related to work zones resulted in 35,000 people injured and more than 700 reported fatalities. In addition, work zones are responsible for almost one-quarter of all nonrecurring freeway delays. Work zones are a necessary part of maintaining and upgrading our highway system, but in recent years, work zone crashes and fatalities have increased. Innovative construction management solutions are needed now more than ever.

Work zones are characterized by traffic pattern changes, narrowed rights-of-way, the presence of construction workers, and work vehicles frequently entering and leaving construction areas. This combination of factors presents challenges for passenger and commercial vehicles driving in and around work zones.

Crashes in and near work zones impact everyone. In addition to injuries and fatalities among travelers, work zones can create hazardous conditions for highway workers. The leading causes of death in the road and bridge construction sector are run overs, back overs, and falls, with many of these fatalities due to vehicle intrusion. Simply put, drivers, passengers, and field workers are all at risk.

The Federal Highway Administration is continuing numerous efforts under its Work Zone Management Program to mitigate the safety and mobility impacts of work zones. “In response to the current environment, the program is working to improve work zones every day, in every way,” says Paul Pisano, leader of FHWA’s Road Weather and Work Zone Management Team.

FHWA’s Work Zone Management Program supports transportation practitioners through a comprehensive set of innovative strategies and tools, including intelligent transportation systems (ITS) technologies, improved data collection, training grants, and resources tailored to the commercial trucking industry and State and local agencies. These tools and programs help with planning, designing, and implementing safer, more efficient, and less congested work zones.

### **Smarter Work Zones**

In 2015, FHWA launched the Smarter Work Zones (SWZ) initiative to help agencies better design, plan, coordinate, and operate work zones. SWZ started as one of 11 selected innovations under round three of FHWA’s Every Day Counts (EDC). SWZ includes two strategies: (1) project coordination to harmonize construction projects to reduce work zone impacts, and (2) technology applications, such as queue management and speed management systems, to dynamically control traffic in and around work zones.

Work zones may be synchronized with other work zones within a corridor, network, or region, and possibly across agency jurisdictions, to minimize combined impacts to travelers and to produce time and cost savings. Early identification of potential impacts enables agencies to improve the coordination of construction activities, resulting in a greater ability to reduce and manage traffic disruptions from road work, minimizing traveler delay and maximizing road work efficiency. ITS technologies support the dynamic management of work zones and provide actionable information to drivers and traffic managers. As a result, drivers can make more informed decisions leading to reduced congestion and improved safety.

**Texas A&M Transportation Institute**



**This dynamic message sign provides travelers with real-time information on the expected travel time to the indicated destination.**

Through EDC efforts, SWZ has been publicized to organizations nationwide. Numerous State and local agencies adopted the initiative, set goals, and showed marked improvements in work zone safety and mobility in their jurisdictions. By the end of the EDC promotional period in December 2016, 9 States had institutionalized project coordination practices and an additional 18 States had incorporated strategies and software tools into their processes for planning, design, operations, and maintenance. Eleven States had mainstreamed technology tools and strategies, and another 28 States had incorporated applications into their agency practices.

### **Smarter Work Zones: Technology Applications**

**Agencies can use a variety of ITS applications to enhance work zone mobility and safety.**

- *Real-time traveler information systems* provide drivers with real-time travel conditions prior to and within a work zone, and may also provide information on alternative routes in the corridor. The goal is to divert drivers away from the work zone when congestion exists.
- *Queue warning systems* quickly detect the presence of congestion at the work zone and warn approaching motorists that traffic is slowed or stopped ahead.
- *Dynamic lane merge systems* encourage motorists to merge at specific points as they approach a lane closure, depending on current operating conditions.
- *Incident management systems* enable agencies, contractors, and responders to detect incidents in the work zone faster, allowing quicker response and clearance.
- *Variable speed limit systems* harmonize speeds before and within the work zone, calming traffic flow and warning of slowed or stopped traffic ahead.
- *Automated enforcement systems* detect and capture images of speeding vehicles for enforcement purposes.



## Smarter Work Zones: Technology Applications

- *Entering/exiting vehicle notification* warns drivers of slow-moving construction vehicles that may be entering the travel lane. It can also warn travelers that a work vehicle is exiting the travel lane and not to follow it into the work space.
- *Performance measurement systems* monitor and archive data on traffic conditions to support real-time traveler information dissemination, modify operations, and facilitate evaluation.

Agency deployments demonstrate the SWZ program's proven impact. For example, the Smart Work Zones program of the Massachusetts Department of Transportation (MassDOT) not only implements ITS-based alerts for road users about work zones but also provides institutionalized procedures and guidelines for the applicability and recommended use of technology applications across the State. According to the concept of operations document for the program, the goal is to consider and apply ITS tools consistently based on a specific impact level and a preset scoring criteria.

"MassDOT is using a wide range of technologies... to get higher quality, real-time traffic data into the hands of its customers... to reduce delays and improve safety through our work zones," says Neil Boudreau, State traffic engineer with MassDOT.

Other examples include the promotion of connected and autonomous vehicle technologies, such as Colorado DOT's demonstration in August 2017 of a first-of-its-kind autonomous impact protection vehicle. Traditional rear protection vehicles are positioned behind road crews to protect workers from traffic, but they still involve risk to the vehicle's driver. The driverless vehicle is designed to withstand hits without the associated risk to a driver. Once positioned in a work zone, the truck mimics the position, speed, and direction of a lead vehicle, which transmits a signal to the trailing driverless vehicle. The truck uses a rear-mounted attenuator, or crash cushion, to absorb or deflect vehicles that cross into work zones.

"[Transportation agencies] across the country want to save lives and make people's lives better," says Shailen Bhatt, Colorado DOT's executive director. "Here in Colorado, every year, six crash attenuator trucks get hit... We want to use automation to get people out of these jobs."

With regard to project coordination, the District of Columbia DOT developed and is currently implementing a citywide transportation management plan to track and evaluate work zone impacts over a 5-year period. The result is cost-effective strategies to mitigate congestion and improve safety and mobility.

While official promotion through EDC concluded in 2016, SWZ resources remain available. Transportation agencies can access the SWZ final report online at [www.fhwa.dot.gov/innovation/everydaycounts/reports/edc3\\_final](http://www.fhwa.dot.gov/innovation/everydaycounts/reports/edc3_final). Other resources, related publications, case studies, tools, demonstration site visits, and webinars are available from FHWA's SWZ website at [www.workzonesafety.org/swz](http://www.workzonesafety.org/swz).

### Work Zone Data Initiative

Data are becoming increasingly integral to the operations and maintenance activities of transportation agencies. Many agencies have long faced the challenge of how to best gather work zone activity data. While once the sole purview of transportation agencies, information on work zone activity has become a topic of interest among an evolving ecosystem of stakeholders, including those developing assistive technologies for work zone management. In response, FHWA recently launched the Work Zone Data Initiative, the largest effort to tackle the data problem to date. The goals of the initiative are (1) to develop a recommended practice for managing work zone data and (2) to create a consistent language for communicating information on work zone activity across jurisdictional and organizational boundaries.

Colorado DOT



**Colorado DOT recently demonstrated the use of a driverless, autonomous vehicle with impact protection. The vehicle uses ITS technology to maintain a position behind a lead vehicle.**

“The program’s mission is broad and forward-looking, and it has significant implications beyond the traditional stakeholders of highway construction,” says Todd Peterson of FHWA’s Work Zone Management Program. “Understanding the current and future applications for the data is key.”

The data initiative is considering how work zone activity is defined and how this contributes to improved performance measurement, forecasting, real-time operations, and programmatic decision making. It is also exploring how data are generated, shared, and used between various stakeholders. Stakeholders include government, industry, academia, and the traveling public; agencies responsible for optimizing work zone safety, mobility, and constructability; and analysts leveraging big data to develop better solutions for traffic control. Other stakeholders to consider include vendors and manufacturers developing connected hardware to facilitate vehicle-to-infrastructure networks, and private-sector traveler information services that track real-time event data in map applications.

FHWA is working with practitioners across the country to develop a national specification for work zone activity data that supports use across the life cycle of project delivery, and with awareness of the broad stakeholder community. FHWA is also exploring potential uses of the data in project planning, real-time operations, and post-activity analytics. The effort includes stakeholder participation in a pilot exchange of open-source data on work zone activity. The initiative will culminate in a series of publications documenting recommended practices for implementing data management specifications and business processes for work zone activity.

For more information, visit FHWA’s Work Zone Management Program website at <https://ops.fhwa.dot.gov/wz/index.asp>.

### **Large Trucks in Work Zones**

Previous research and outreach have focused largely on passenger vehicle safety and mobility in work zones. However, the challenges that large trucks and buses must contend with when driving through work zones are different and more complex. Longer stopping distance requirements, larger blind spots, reduced maneuverability due to narrower lanes, and reduced brightness or increased glare during nighttime operations create hazards that can lead to injuries and fatalities.

Every year, large trucks are overrepresented in fatal work zone crashes. In 2016, 184 crashes involved large trucks, accounting for more than one-quarter of fatal work zones crashes nationwide. By comparison, only 9 to 12 percent of fatal crashes outside of work zones involve large trucks each year.

To address this overrepresentation, FHWA is partnering with Federal and State government agencies, trucking associations, and other safety stakeholders to conduct a multiyear campaign to improve large truck safety in work zones. The agency has developed and continues to grow its suite of resources, including webinars, brochures, and guidance documents.

In 2015, FHWA enhanced these efforts with the National Symposium on Work Zones and Large Trucks. More than 90 practitioners from State DOTs, FHWA, the American Association of State Highway and Transportation Officials, the American Traffic Safety Services Association, the Commercial Vehicle Safety Alliance, the Federal Motor Carrier Safety Administration, and the National Highway Traffic Safety Administration, as well as various law enforcement agencies, academia, and other industry representatives came together for a day of discussion to identify focus areas and solutions.

“Truck drivers deal with many unique challenges due to [the vehicles’] size and maneuverability,” says Herschel Evans of America’s Road Team, a national public outreach program. “It is critically important for drivers to know when work zones are active. The more advanced the warning, the more likely the driver is to be in the right mindset to safely maneuver through it.”

The symposium resulted in FHWA developing an outreach plan to enhance current efforts. Additionally, FHWA and others are integrating messaging about large trucks into efforts like National Work Zone Awareness Week to get the word out.

### **Work Zone ITS Planning Tool**

It is crucial for highway agencies to identify how best to manage each work zone. FHWA’s Work Zone Intelligent Transportation Systems Implementation Guide (FHWA-HOP-14-008) provides practitioners with step-by-step guidance to determine the feasibility, design, and deployment for application-specific ITS technology for work zones.

© Oleg Bezrukov, Shutterstock.com



**Several types of crashes involving large trucks can occur in work zones, like the rear-end collision shown here.**

FHWA recently developed a companion Work Zone ITS Implementation Tool. The tool helps simplify the process of planning, designing, and deploying work zone ITS by streamlining the collection of relevant data, facilitating sharing and collaboration, supporting decisionmaking based on user input, and providing useful feedback based on the principles of the guidebook. For more information, visit <https://itsforge.net/index.php/community/explore-applications#/40/150> or see “Improving Safety and Mobility: ITS in Work Zones” on page 44 in this issue of Public Roads.

### **Work Zone Safety Grant Program**

External partnership support is key to FHWA’s mission of reducing work zone-related safety impacts. FHWA’s Work Zone Safety Grant Program provides funding to nonprofit and not-for-profit organizations to develop safety-related guidelines and training courses for field workers and agency and private-sector practitioners. As of 2017, FHWA has awarded more than \$40 million in grant funds, with the following outcomes:

- Trained more than 101,000 practitioners and craft workers
- Conducted more than 3,800 training courses
- Offered more than 95 training modules, such as work zone designer training and work zone road safety audits
- Developed a comprehensive e-learning program
- Produced more than 55 guideline publications

FHWA will continue funding the development of new products through 2022. “These guidelines, training courses, and other resources are expected to provide benefits and positive impacts for years to come,” says Martha Kapitanov of FHWA’s Work Zone Management Program.



Queue warning signs like this one alert drivers of congestion or stopped traffic ahead.

For more information, visit [www.workzonesafety.org/training-resources/fhwa\\_wz\\_grant](http://www.workzonesafety.org/training-resources/fhwa_wz_grant).

### **Additional Resources for State and Local Agencies**

To support State and local transportation agencies in enhancing their work zone management practices, FHWA has produced a number of publications and other resources.

When conducting work zone planning efforts, agencies must develop and implement a transportation management plan. This plan lays out what strategies should be used and how. The plan might include temporary traffic control measures and devices, operational strategies, and public information and outreach.

To support practitioners in formulating a consistent approach to assess the effectiveness of their selected management strategies, FHWA published the Transportation Management Plan Effectiveness Framework and Pilot (FHWA-HOP-16-062) report. For each strategy, the report includes an inventory of measures of effectiveness along with a framework to guide users on the methods, scope, and effectiveness of their evaluations. FHWA also produced Federal-Aid Essentials videos on Transportation Management Plan (TMP) Requirements and Work Zone Traffic Control Reviews. The videos and many more are available at [www.fhwa.dot.gov/federal-aidessentials/indexofvideos.cfm](http://www.fhwa.dot.gov/federal-aidessentials/indexofvideos.cfm). Self-paced online TMP training modules are available at <https://ops.fhwa.dot.gov/wz/outreach/outreach.htm>.

The Code of Federal Regulations (CFR) mandates that State agencies receiving Federal-aid funds perform work zone process reviews every 2 years. In 2015, FHWA published an updated process review document, *Guidance for Conducting Effective Work Zone Process Reviews* (FHWA-HOP-15-013), to share best practices and proven methods used by States for these reviews. By implementing these practices, agencies will find more consistent and targeted improvement in work zone policies and procedures.



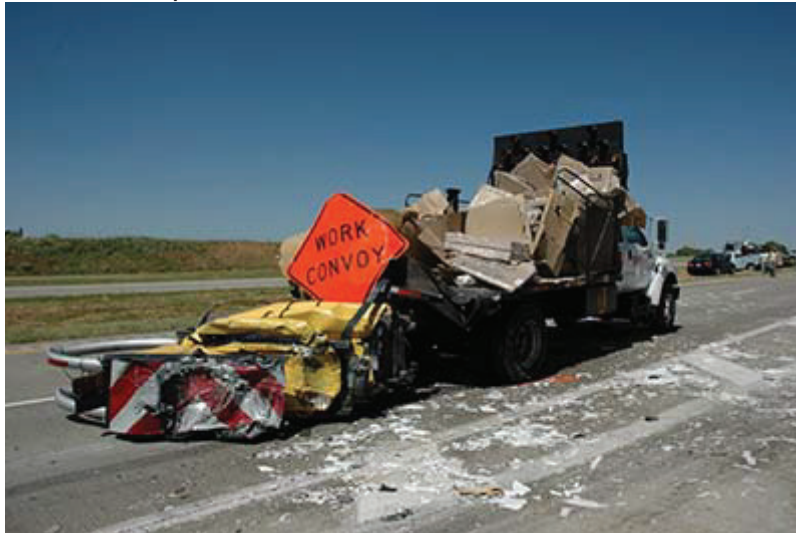

**Trucks in work zones may be equipped with attenuators, such as this one shown after a crash, to absorb the impact of vehicles that cross into a work zone, protecting the highway workers.**

In addition, a transportation agency's institutional capabilities impact its ability to manage work zones effectively. FHWA created its Work Zone Capability Maturity Framework to help practitioners assess the capability of their agency or region to effectively manage work zones. This includes assessing work zone impacts and implementing strategies for mitigating those impacts. FHWA is providing support through in-person workshops to engage regions in identifying capability levels as well as prioritizing and creating action plans to enhance their capabilities. The framework is available at [https://ops.fhwa.dot.gov/tsmoframeworktool/available\\_frameworks/work\\_zone.htm](https://ops.fhwa.dot.gov/tsmoframeworktool/available_frameworks/work_zone.htm).

FHWA continues to look for new ways to improve work zone safety and to help State and local agencies in their efforts. Recently, FHWA kicked off work to develop specific criteria and guidelines for the use of "positive protection" devices in highway work zones. These devices contain or redirect intruding vehicles and include various types of barriers and shadow vehicles with energy-absorbing attenuators. The CFR requires transportation agencies responsible for temporary traffic control planning and design to consider the use of positive protection in work zones. The positive protection devices should be used when work zone conditions place workers at an increased risk of being struck by vehicles and where the devices offer the highest potential for increasing safety for workers and road users. FHWA's guidelines will help transportation agencies determine appropriate devices and when and how to deploy them. FHWA expects to release the guidelines in 2019.

"Work zones are an integral part of maintaining our country's roads," says Mark Kehrl, director of FHWA's Office of Transportation Operations. "Through FHWA efforts, we are helping to save lives and increase mobility across the Nation's transportation network."

---

**Jawad Paracha** is the manager of the Work Zone Management Program in FHWA's Office of Transportation Operations. He holds a master of engineering degree in transportation engineering and

planning from the University of Maryland, College Park, and a bachelor of science degree in civil engineering from the University of Engineering and Technology in Peshawar, Pakistan.

**Rachel Ostroff** is a senior manager in ICF's Transportation Group. She holds a master of science degree in transportation engineering from Cornell University and a bachelor of science degree in civil engineering from the University of Maryland, College Park.

*For more information, see <https://ops.fhwa.dot.gov/wz/index.asp> or [www.workzonesafety.org](http://www.workzonesafety.org), or contact Jawad Paracha at 202-366-4628 or [jawad.paracha@dot.gov](mailto:jawad.paracha@dot.gov).*



Smart Work Zone Systems by Prahlad Pant, PhD, February 2017.  
[https://ops.fhwa.dot.gov/wz/workshops/accessible/Pant\\_paper.htm](https://ops.fhwa.dot.gov/wz/workshops/accessible/Pant_paper.htm)

# Smart Work Zone Systems

[Workshops](#) > [Work Zone Information](#)

by

Prahlad D. Pant, Ph.D.

PDP Associates Inc.

2367 Springdale Road

Cincinnati, OH 45231

Ph: 513-226-6009

Fax: 513-851-1019

E-mail: [Pant@PDPassociates.com](mailto:Pant@PDPassociates.com)

[www.PDPassociates.com](http://www.PDPassociates.com)

## 1.0 Introduction

A freeway construction work zone generally creates conflicts between vehicular traffic and work activity. Work zones not only lead to traffic conditions that violate motorists' expectations but also expose construction workers hazardously close to the fast moving vehicles. The closure of one or more lanes of a freeway section causes a bottleneck on the freeway and reduces the capacity in the work zone. Such a work zone situation is a challenge to one of the main objectives of a traffic management system - the *safe and efficient* movement of traffic. In the case of congestion that leads to queuing up of vehicles for several miles of the freeway, the motorists are generally not aware of what is going on ahead of them and how long it will take them to clear the work zone. This is because the information on changeable message signs (CMSs) that are posted along the freeway do not provide real-time information on the expected travel time, delay or speed. Typical displays include "*Construction Ahead - Expect Delays*" or "*Possible Delay Ahead*" - but for how long and why, nobody knows. Such messages do not provide specific, accurate and reliable information about the construction and, more often than not, they end up being ignored by motorists. The lack of *real-time* information is one of the major causes of motorist frustrations in work zones, wherein neither can they plan trips successfully nor adjust their trips based on the information provided. In general, once the motorists get trapped in a traffic jam on the freeway, they are left with no information as to the extent of the jam, its cause, and for how long they are going to be trapped on the freeway. Despite the possible existence of alternate routes, if no definite travel time or delay information is available, drivers are generally hesitant to take such alternate routes as in most cases they are not familiar with the adjacent routes.

A major problem in freeway work zones is the safety of motorists and workers. If motorists are not provided with real-time information, they don't know what delay, speed or travel time can be expected on the freeway. They are caught by surprise when vehicles ahead of them suddenly begin to brake, which often leads to rear-end accidents. Vehicles stray into the work area injuring construction workers. The result is a higher than normal crash rates in freeway work zones.

There exists a necessity to provide accurate and reliable real-time information to motorists as to how long it will take them to clear the work zone, how long they will be delayed by the lane closure, or what speed they can expect ahead of them. This information needs to be provided at reasonable intervals in advance of the work zone as well as through the work zone. The immediate benefit of this kind of information is that it would help the motorists decide whether to stay on the freeway or to take an alternate route since they are now aware of the expected delay due to the work zone.

## 2.0 Characteristics of Smart work Zone Systems

In recent years, the above-mentioned concerns and necessities have led to the development of smart work zone systems that are designed to predict travel time, delay or speed on a freeway work zone, on a real-time basis. These systems are intended to better inform motorists, encourage them to take alternate routes, reduce their frustrations, reduce freeway congestion, and enhance safety for motorists and workers. These systems can be used to provide real-time information to motorists during incidents, temporary closures, or any unexpected conditions on the freeway.

A "smart work zone system" is the application of computers, communications, and sensor technology to freeway transportation and would possess the following general characteristics:

- a. *Real-time*: The system obtains and analyzes traffic flow data in real-time, providing frequently updated information to motorists.
- b. *Portable*: The system is portable, hence allowing its installation (with minor modifications as necessary) at different locations.
- c. *Automated*: The system operates in an automated manner with as minimal supervision as possible by human operators.
- d. *Reliable*: The system provides accurate and reliable information, keeping in mind the serious consequences of misinforming motorists in work zone situations.

These systems, if properly designed and implemented, will:

- Better inform motorists and reduce their frustrations;
- Encourage motorists to take alternate routes;
- Reduce congestion and allow more freely flowing traffic;
- Clear incidents more quickly, thereby reducing secondary incidents;
- Make work zones safer for highway workers and motorists.

In recent years, several companies have developed and implemented smart work zone systems in different states. These companies and their systems are listed in Table 1. A review of these systems is outside the scope of this paper. More systems are expected to be offered by the private sector in the future.

In the following sections, we offer two examples of smart work zone systems called

1. TIPS (Traffic Information & Prediction System) and
2. ASIS (Advance Speed Information System).

These systems can be used in urban as well as rural freeways. A brief description of these systems is provided below

**Table 1.**

Company Name	Name of System
PDP Associates Inc.	(i) TIPS (Traffic Information and Prediction System) and (ii) ASIS (Advance Speed Information System)
ASTI Transportation Systems	CHIPS (Computerized Highway Information System)
ADDCO	Smart Zone
National Intelligent Traffic Systems	ITSWorkzone
Scientex Corporation	ADAPTIR (Automated Data Acquisition and Processing of Traffic Information in Real-time)
United Rentals	AIMS (Automated Information Management System)

(Note: The above list is provided for information only. The author is not familiar with the working or suitability of any system except TIPS and ASIS. For more information, the reader may contact individual companies)

### **3.0 Traffic Information & Prediction System (TIPS)**

The Traffic Information & Prediction System (TIPS) is a portable, real-time, automated, accurate and reliable system for predicting and displaying travel time for motorists in advance of and through work zones. It collects real-time traffic flow data using roadside non-contact sensors, processes the data in an on-site personal computer, calculates estimated travel times between different points on the freeway, and displays travel time information on portable, electronic changeable message signs positioned at pre-determined locations along the freeway. TIPS can be used as an efficient incident management tool for providing real-time information about accidents, emergency highway closures etc. to the motorists. The system has been designed to incorporate features that make the system adaptable to different work zones. TIPS allows motorists to make decisions about staying on the freeway or taking an alternate route, based on the information displayed on the changeable message signs.

The major components of TIPS are as follows:

- Microwave radar sensors for vehicle detections on each lane of the freeway;
- Microcontrollers for processing the traffic flow data;
- Radios for transmitting traffic flow data to the on-site personal computer (PC), and from the PC to portable changeable message signs;
- Mobile trailers with solar panels and batteries for providing electric power to field equipment;
- Changeable message signs with radios for displaying travel time information to motorists;
- Intelligent traffic algorithm and travel-time estimation models residing in the specially-developed TIPS software in Windows 2000 environment.

Other features of TIPS include:

- a. a website for providing real-time information to motorists, and
- b. video cameras for bringing live traffic pictures to the project office and displaying in the website.

The Base Station, consisting of a Personal Computer with the TIPS software and a radio, polls each sensor at 30-sec intervals and receives traffic flow data for each lane. It calculates travel times between different points on the freeway and sends instructions to changeable message signs to display specific real-time travel time messages. The changeable message signs display the messages and send confirmations to the Base Station. TIPS operates in a fully automated mode with minimal human supervision.

TIPS is equipped with a telephone dial-up feature that allows full control of the system from any remote location (office, home etc.). This particular feature is useful for incident management, which allows public agencies to display customized messages on the changeable message signs when necessary. For example, in the case of an emergency when motorists need to be informed of an accident, or when a freeway needs to be completely closed, project officials can remotely transmit special messages to one or more signs from any place.

A few examples of messages displayed by TIPS are shown below. Although TIPS has been shown to display travel times in these examples, the system is equally capable of displaying real-time delay or speed as necessary. *The signs below read: '40 MIN TO END OF WORKZONE', 'WORKZONE ENDS 15 MILES', '44 MIN TO END OF WORKZONE', 'WORKZONE ENDS 19 MILES', 'ACCIDENT AHEAD', and 'HIGHWAY CLOSED AHEAD'.*

TIPS was successfully deployed in the following work zones during the past two years:

(1) Deployment in 2000:

- I-75 Dayton, Ohio
  - Urban (Downtown)
  - Work zone - 3 miles
  - Advance area - 11 miles

(2) Deployments in 2001

- I-75 Dayton, Ohio
  - Urban (Downtown)
  - Work zone - 3 miles
  - Advance area - 11 miles

(3) Deployment in 2001

- I-94 Milwaukee, Wisconsin
  - Semi-rural
  - Work Zone - 12 miles
  - Advance area - 7 miles

## **Independent Evaluation of TIPS in Dayton, Ohio**

When TIPS was deployed on a 14-mile segment of northbound Interstate 75 in Dayton, Ohio during the Summer and Fall of 2000, the Ohio Department of Transportation (ODOT) hired Dr. Helmut Zwahlen, Russ Professor Emeritus at Ohio University, to conduct an independent evaluation of TIPS. The results of the study (Final Report, March 2001) are summarized in the following abstract.

"A real-time travel time prediction system (TIPS) was evaluated in a construction work zone. TIPS includes changeable message signs (CMSs) displaying the travel time and distance to the end of the work zone to motorists. The travel times displayed by these CMSs are computed by an intelligent traffic algorithm and travel-time estimation model of the TIPS software, which takes input from microwave radar sensors that detect the vehicle traffic on each lane of the freeway. Besides the CMSs and the radar sensors, the TIPS system includes the computer and microcontroller computing the travel times, 220 MHz radios for transmitting data from the sensors to the computer and from the computer to the CMSs, and trailers with solar panels and batteries to power the radar sensors, CMSs, and radios. The evaluation included an accuracy analysis between the predicted and actual recorded travel times and a survey of the motoring public. Three crews driving independently of each other in the traffic stream recorded predicted and actual travel times at three CMSs to the end of the work zone for 12 hours each day for three consecutive days, resulting in 119 trial runs. The data recorder in each crew also recorded the license plate numbers of private non-commercial vehicles with Ohio license plates. A total of 3177 different license plate numbers were recorded and a questionnaire was sent to each one. A total of 660 completed surveys were returned and analyzed. Based on the regression analysis of actual times vs. predicted times, the system does on the average a reasonable job in predicting the travel times to the end of the work zone. About 88% of the actual times recorded for each sign, and for all the signs combined, were within a range of  $\pm 4$  minutes of the predicted time. However, a few differences (actual - predicted) as great as 18 minutes were observed. Survey responses indicated that the motoring public does perceive a certain inaccuracy in the travel times. However, almost 97 % of surveyed motorists felt that a system to provide real-time travel information in advance of work zones is either outright helpful or maybe helpful. In summary we may conclude that the real-time TIPS system represents a definite improvement over any static non-real-time display system. It provides in general and most of the time useful and relatively accurate travel time predictions to the motoring public and appears to be perceived by the motoring public as helpful and useful."

Two specific results of TIPS evaluation in Dayton, Ohio will be presented below:

(1) The study revealed that the time differences for all three changeable message signs combined were as shown in the following table.

**Table 2. Time Difference Data for All Three CMSs Combined**

Minutes Off	Frequency	Percentage	Cumulative Percentage
0	49	14%	14%
1	117	33%	47%
2	75	21%	68%
3	51	14%	82%
4	20	6%	88%
5-8	17	5%	93%
>8	26	7%	100%
<i>Total</i>	<i>355</i>	<i>100%</i>	

(2) In reply to the question "Do you think that such a travel time prediction system in advance of work zones and in advance of exits in heavily traveled freeways where drivers could select an alternate route in situations where long travel times to the end of the work zone are predicted is helpful to the motoring public?", the motorists responded as follows:

*Pie Chart Results-Motorists responded with:*

*Yes, helpful (565) 85%*

*No, not helpful (17) 3%*

*Maybe (73) 11%*

No response, (5) 1%

### **Independent Evaluation of TIPS in Milwaukee, Wisconsin**

TIPS was deployed on Interstate 94 in Milwaukee, Wisconsin during the construction season of 2001 and evaluated for five States (Iowa, Kansas, Missouri, Nebraska and Wisconsin) that comprise the Midwest Smart Work Zone Deployment Initiative. The evaluation was performed by the University of Wisconsin-Milwaukee and Marquette University. The results of the evaluation were not available at the time of writing this paper. However, a preliminary report of the diversion studies performed by Professor Alan Horowitz of University of Wisconsin-Milwaukee and provided to the author by the Wisconsin Department of Department has concluded that "the before and after analysis supports the notion that TIPS is influencing drivers to change their routes". During this deployment, TIPS provided the motorists with information on real-time travel time to the end of the work zone but did not provide any information as to the availability of alternative routes. The advance area of I-94 had three lanes, which was reduced to two lanes in the work zone. The work zone had a two-lane frontage road that had stop-controlled intersections usually spaced about one mile apart. The road itself jogged at a few places, perhaps giving the impression that it was discontinuous. On Sunday afternoons, which carried the heaviest hourly traffic volumes during the months of July and August, the traffic volume on I-94 averaged to 3144 vehicles per hour between 2 pm and 6:45pm. The before and after analysis showed that 10.0 percent of I-94 drivers chose an alternative route.



## Summary of Lessons Learned from Ohio and Wisconsin Deployments

The Ohio and Wisconsin deployments have shown that TIPS is a reliable work zone system that provides:

- a. Accurate travel time information;
- b. Is overwhelmingly liked by motorists;
- c. Influences drivers to change their routes;
- d. Is an efficient tool for incident management; and
- e. Can be successfully deployed on both urban and rural freeways.

When the final report of the independent evaluation of TIPS in Milwaukee becomes available in the coming months, it is expected to provide further insights on the accuracy, reliability, and impacts of the system.

## 4.0 Advance Speed Information System

The Advance Speed Information System (ASIS) is a portable, real-time, automated system that calculates vehicular speeds at downstream segments of a freeway and displays the speed information on changeable message signs at upstream locations. By providing accurate speed information in advance, ASIS assists motorists to adjust their speed according to the most current traffic conditions and reduces the element of "surprise" that often leads to rear-end crashes.

An "ASIS sign" is a changeable message sign that has a microwave radar sensor, microcontroller, radio, modem, and antenna mounted on it and integrated as one device. The system works in the following way: Two or more ASIS signs are placed in series at previously-determined locations along the freeway including (a) advance areas where traffic backups are likely to occur and (b) the work zone itself where conditions can change quite frequently due to the changing needs of construction operations. The sensor picks up signals from each vehicle on each lane, the on-board computer calculates current speed at 30-sec intervals, and the radio/modem transmits speed information to an upstream sign, which is displayed to the motorists in an appropriate format. Examples of messages include:

*The signs below read: 'SLOW DOWN', 'SPEED AHEAD 30 MPH', 'PREPARE TO STOP', 'SPEED AHEAD 10 MPH', 'PREPARE TO STOP', and 'STOPPED TRAFFIC AHEAD ', 'NEXT ONE MILE' and 'SPEED AHEAD 25 MPH'.*

At least two signs are needed for the operation of this system. Any number of signs can be added as necessary. ASIS signs operate as stand-alone devices and no central control from a Base Station is required for their operation. The system runs 24 hours/day, seven days/week in automated mode.

Optionally, ASIS can be provided with a Base Station that centralizes the operation of the whole system. The Base Station allows project officials to transmit customized messages to any or all signs for incident management. For examples of these messages please refer to the previous photos in the TIPS section.

ASIS is a flexible system that can be tailored to meet the needs of any freeway. ASIS is expected to reduce rear-end crashes and enhance the safety of motorists and workers. Although ASIS was first developed for work zones, it can be deployed on any freeway that experiences recurring or non-recurring congestion.

(For more information on TIPS or ASIS, please visit the website [www.PDPassociates.com](http://www.PDPassociates.com).)

## **5.0 Conclusions**

Smart work zone systems are designed to improve the safety of highway workers and traveling public, the efficiency of incident management, and the reliability of highway traffic operations while minimizing congestions delays. As evidenced by the independent evaluations of TIPS previously-described in this paper, a smart work zone can provide reliable and accurate information, which can be used by motorists for making decisions. With selection of proper systems and their applications, transportation agencies can provide valuable service to traveling motorists and construction workers in work zones.



U.S. Department of Transportation  
**Federal Highway Administration**

# Work Zone Intelligent Transportation Systems Implementation Guide

Use of Technology and Data for Effective  
Work Zone Management

January 2014



### **Notice**

This document is disseminated under the sponsorship of the Department of Transportation in the interest of information exchange. The United States Government assumes no liability for its contents or use thereof. This report does not constitute a standard, specification, or regulation.

The United States Government does not endorse products or manufacturers. Trade and manufacturers' names appear in this report only because they are considered essential to the object of the document.

### **Quality Assurance Statement**

The Federal Highway Administration (FHWA) provides high-quality information to serve Government, industry, and the public in a manner that promotes public understanding. Standards and policies are used to ensure and maximize the quality, objectivity, utility, and integrity of its information. FHWA periodically reviews quality issues and adjusts its programs and processes to ensure continuous quality improvement.

Cover photo and chapter heading photos courtesy of Shutterstock, Fotolia, and Veer.

1. Report No. FHWA-HOP-14-008		2. Government Accession No.		3. Recipient's Catalog No.	
4. Title and Subtitle Use of Technology and Data for Effective Work Zone Management: Work Zone ITS Implementation Guide				5. Report Date January 2014	
				6. Performing Organization Code	
7. Author(s) Gerald Ullman (TTI); Jeremy Schroeder, Deepak Gopalakrishna (Battelle)				8. Performing Organization Report No.	
9. Performing Organization Name and Address Battelle Texas A&M Transportation Institute 505 King Ave. The Texas A&M University System Columbus, OH 43201 College Station, Texas 77843-3135				10. Work Unit No. (TRAVIS)	
				11. Contract or Grant No. DTFH61-06-D-0007 / BA07-101	
12. Sponsoring Agency Name and Address Federal Highway Administration Office of Operations (HOP) 1200 New Jersey Avenue SE Washington, DC 20590				13. Type of Report and Period Covered	
				14. Sponsoring Agency Code	
15. Supplementary Notes Project performed in cooperation with the U.S. Department of Transportation, Federal Highway Administration. Tracy Scriba, project lead					
16. Abstract  ITS is the use of a broad range of communications-based information and electronics technologies to enhance transportation. Work zone ITS is the use of ITS to enhance transportation and improve safety and mobility in and around work zones. A work zone ITS deployment can be focused around safety or mobility, but often supports both goals, and can also enhance productivity. The systems are portable and temporary in most cases, although some deployments may use either existing fixed infrastructure or become a permanent system.  The purpose of this document is to provide guidance on implementing ITS in work zones to assist public agencies, design and construction firms, and industry, including developers, manufacturers, distributors, packagers, and providers of devices, systems, and programs. Work zone ITS is one possible operational strategy of many potential solutions that an agency can include in a transportation management plan (TMP). This document summarizes key steps for successfully implementing ITS in work zones, using a systematic approach to provide a technical solution that accomplishes a specific set of clearly defined objectives. The document illustrates how a systems engineering process should be applied to determine the feasibility and design of work zone ITS for a given application, regardless of its scale, by walking through the key phases, from project concept through operation. These steps include assessment of needs; concept development and feasibility; detailed system planning and design; procurement; system deployment; and system operation, maintenance, and evaluation.					
17. Key Words Work zones, intelligent transportation systems, ITS			18. Distribution Statement No restrictions. This document is available to the public.		
19. Security Classif.(of this report) Unclassified		20. Security Classif. (of this page) Unclassified		21. No. of Pages 80	22. Price

Reproduction of completed page authorized

<b>INTRODUCTION</b>	1
What is work zone ITS?	1
Some current technology options and strategies	2
Benefits that are possible with work zone ITS	4
Purpose and organization of this document	4

### **STEP 1 – ASSESSMENT OF NEEDS** 7

1.1	What are the user needs?	7
1.2	What are the system goals and objectives?	9
1.3	Who are the stakeholders?	11
1.4	Who should be on the project team?	12
1.5	What, if any, existing ITS resources are available?	12

### **STEP 2 – CONCEPT DEVELOPMENT AND FEASIBILITY** 15

2.1	What is the overall work zone ITS concept of operations?	15
2.2	What ITS solutions are available?	18
2.3	What are the potential benefits of an ITS deployment?	21
2.4	How much will an ITS deployment cost?	21
2.5	What are potential institutional and jurisdictional challenges?	22
2.6	Addressing legal and policy issues	23
2.7	How can project feasibility be established?	23
2.8	How can buy-in be obtained from stakeholders and other agencies?	27

### **STEP 3 – DETAILED SYSTEM PLANNING AND DESIGN** 29

3.1	Determining system requirements and specifications	29
3.2	Developing the system design	31
3.3	Developing a testing strategy	32
3.4	Planning for operations and maintenance	33
3.5	Determining staff training needs for those using and operating the work zone ITS	33
3.6	Planning for public outreach	34
3.7	Investigating system security	36
3.8	Planning for evaluation	36
3.9	Estimating system benefits and costs	39

### **STEP 4 – PROCUREMENT** 41

4.1	Overview of procurement approaches	41
4.2	Deciding between direct or indirect procurement	43
4.3	Determining the procurement award mechanism	46
4.4	Issuing a request for proposals or bids	46
4.5	Selecting the preferred vendor, consultant, or contractor	47

### **STEP 5 – SYSTEM DEPLOYMENT** 51

5.1	Implementing the system plans	52
5.2	Scheduling decisions	52
5.3	System acceptance testing	53
5.4	Handling major deployment issues	53

### **STEP 6 – SYSTEM OPERATION, MAINTENANCE, AND EVALUATION** 55

6.1	Dealing with changing work zone conditions	55
6.2	Using and sharing ITS information	56
6.3	Maintaining adequate staffing	58

6.4	Leveraging public support	58
6.5	Conducting system monitoring and evaluation	58
6.5.1	System monitoring	58
6.5.2	System modification	59
6.5.3	Final evaluation	60

### List of Appendices

Appendix A.	National ITS Architecture	61
Appendix B.	Summary of Resources Reported in this Document	63
Appendix C.	Issues for Consideration	65
Appendix D.	Acknowledgements	68

### List of Figures

Figure 1.	A portable changeable message sign providing downstream traffic speeds from sensor data.	1
Figure 2.	Temporary, solar-powered vehicle detection and camera systems.	2
Figure 3.	Sequencing comparative travel time sign at a decision point for two different routes to the town of Lehi that was used for a project in Utah.	5
Figure 4.	Overview of the implementation process.	5
Figure 5.	Sub-steps to be explored in Step 1.	7
Figure 6.	Example of a work zone and area of expected impacts.	10
Figure 7.	Existing ITS resources can be used to help manage the work zone and reduce costs.	12
Figure 8.	Sub-steps to be explored in Step 2.	15
Figure 9.	General outline showing the sections of a formal concept of operations document based on the IEEE 1362-1998 standard.	16
Figure 10.	High-level sketch for the concept of operations of a work zone ITS deployment in Utah.	17
Figure 11.	The product of this step should include concept of operations scenarios, such as this graphic for a work zone traffic management system.	28
Figure 12.	Sub-steps to be explored in Step 3.	29
Figure 13.	Requirements for a work zone ITS deployment in Minnesota.	30
Figure 14.	The Las Vegas Freeway and Arterial System for Transportation (FAST) provides regional support for work zone activities.	31
Figure 15.	Example press release for a work zone in New Hampshire.	35
Figure 16.	PCMS in several states have been illegally accessed and had messages changed.	36
Figure 17.	Overall evaluation process for ITS applications in work zones.	38
Figure 18.	Sub-steps to be explored in Step 4.	41
Figure 19.	Agencies must select the work zone ITS type first, which could impact the type of procurement method and award mechanism that are used.	42
Figure 20.	Sub-steps to be explored in Step 5.	51
Figure 21.	Sub-steps to be explored in Step 6.	55
Figure 22.	PCMS messages were modified from a generic message (left) as stated in the contract to a more specific message (right).	59





## List of Tables

Table 1. Sample work zone ITS applications.	3
Table 2. Examples of site-specific issues and problems.	8
Table 3. ITS components.	18
Table 4. Communication options, advantages, and disadvantages.	20
Table 5. Examples of benefits for various work zone ITS.	21
Table 6. Example set of scoring criteria to establish feasibility of work zone ITS.	25
Table 7. Possible work zone ITS applications to consider for various critical project characteristics.	26
Table 8. Example evaluation criteria.	39
Table 9. Summary table of procurement methods.	45

## Acronyms and Abbreviations

<b>AASHTO</b>	American Association of State Highway and Transportation Officials
<b>ADT</b>	Average Daily Traffic
<b>ATIS</b>	Advanced Traveler Information System
<b>ATSSA</b>	American Traffic Safety Services Association
<b>AVI</b>	Automatic Vehicle Identification
<b>AVL</b>	Automatic Vehicle Location
<b>CCTV</b>	Closed-Circuit Television
<b>CITE</b>	Consortium for ITS Training and Education
<b>CMS</b>	Changeable message sign
<b>COTS</b>	Commercial Off-The-Shelf
<b>DB</b>	Design-Build
<b>DOT</b>	Department of Transportation
<b>FCC</b>	Federal Communications Commission
<b>FHWA</b>	Federal Highway Administration
<b>GPS</b>	Global Positioning System (Satellite)
<b>HAR</b>	Highway Advisory Radio
<b>IP</b>	Internet Protocol
<b>ITS</b>	Intelligent Transportation Systems
<b>IDAS</b>	ITS Deployment Analysis System
<b>JPO</b>	Joint Program Office
<b>LED</b>	Light Emitting Diode
<b>LTAP</b>	Local Technical Assistance Program
<b>MCO</b>	Maintenance & Construction Operations
<b>MOE</b>	Measure of Effectiveness
<b>MUTCD</b>	Manual of Uniform Traffic Control Devices
<b>NCHRP</b>	National Cooperative Highway Research Program
<b>NHI</b>	National Highway Institute
<b>NTCIP</b>	National Transportation Communications for ITS Protocol
<b>PCB</b>	Professional Capacity Building
<b>PCMS</b>	Portable Changeable message sign
<b>RFID</b>	Radio Frequency Identification
<b>RFP</b>	Request for Proposals
<b>RITA</b>	Research and Innovative Technology Administration
<b>TMC</b>	Transportation Management Center
<b>TMP</b>	Transportation Management Plan
<b>TRB</b>	Transportation Research Board
<b>UNII</b>	Unlicensed National Information Infrastructure
<b>VSL</b>	Variable Speed Limit
<b>VMT</b>	Vehicle Miles Traveled
<b>V2I</b>	Vehicle-to-Infrastructure
<b>V2V</b>	Vehicle-to-Vehicle
<b>Wi-Fi</b>	Wireless Internet/Network

# INTRODUCTION

Highway work zones present challenges to work zone safety and mobility. Work zones often reduce roadway capacity, causing congestion and traveler delay and creating irregular traffic flow. These factors, as well as the changing lane configurations and other factors in work zones, can lead to safety hazards. There are more than 500 fatalities and 37,000 injuries in work zones every year.<sup>1</sup> However, work zones are a necessary part of maintaining and rehabilitating our transportation infrastructure. These needs are increasing as our transportation system ages, which means more work zones will likely occur. These factors all combine to create challenges to moving traffic smoothly and safely through work zones and which heightens the need for finding new ways to enhance work zone traffic management. Agencies are deploying intelligent transportation systems (ITS) to help manage traffic in and around work zones more efficiently.

## What is work zone ITS?

ITS is the use of a broad range of communications-based information and electronics technologies to enhance transportation. These systems generally include:

- Sensors and other components in the field to collect traffic information, such as traffic volumes and speeds and video of traffic flow
- Communications links (wireless and wired) to transmit that data for processing or dissemination
- Software that processes and analyzes the data, converting it to information that can be used by other components and various users of the information
- Electronic equipment to disseminate the processed information to end users of the information, such as motorists and transportation agencies.

Work zone ITS is the use of ITS to enhance transportation and improve safety and mobility in and around work zones. Information provided by work zone ITS may be in the form of real-time traffic conditions, such as travel delays through a work zone or recommended diversion routes, which can be used by motorists to alter their travel behavior and by contractors and transportation agencies to alter traffic control strategies, traveler information, or work schedules. Work zone ITS may also be used to provide immediate warnings, such as to drivers that traffic is stopped ahead

or that a slow truck is entering from a work zone or to workers that a vehicle is intruding into their work area.

A work zone ITS deployment can be focused around safety or mobility, but often supports both goals, and can also enhance productivity. The systems are portable and temporary in most cases, although some deployments may use either existing fixed infrastructure or become a permanent system.

A work zone ITS deployment varies in scale based on the magnitude of the construction project and the specific concerns being addressed in a given location. Not all ITS deployments are complicated and expensive. One of the most common components of a work zone ITS deployment is a portable changeable message signs (PCMS) that can be used to communicate traffic conditions to motorists, as shown in Figure 1, based on real-time traffic data collected from sensors.

ITS deployments can have the same objective, but vary widely in how the objective is achieved. Factors that vary from deployment to deployment include:

- What type of data is collected (e.g., traffic volumes and speeds, queue detection);
- How data is collected (e.g., radar, cameras);
- How data is communicated (e.g., cellular, Bluetooth, fiber optic connection);
- What level of detail of information is disseminated (e.g., “slow traffic ahead”, “speed ahead 35 mph”);
- How that information is shared (e.g., websites, PCMS);
- How “real-time” the information is (e.g., predicted, based on current speeds).



Figure 1. A portable changeable message sign providing downstream traffic speeds from sensor data.

<sup>1</sup> As of 2010; for more information, see: [http://www.ops.fhwa.dot.gov/wz/resources/facts\\_stats/injuries\\_fatalities.htm](http://www.ops.fhwa.dot.gov/wz/resources/facts_stats/injuries_fatalities.htm).

Work zone ITS may be leased or purchased through variety of procurement mechanisms. In some cases, data may be leased/purchased from a third party that is already collecting the data (e.g., through Bluetooth) and the ITS is primarily used to process and disseminate the information.

Users of the information provided by work zone ITS may include departments of transportation (DOTs), the public and road users, nearby businesses and employers, media outlets, contractors, trucking companies, emergency services providers, motorist assistance patrols, and third party traveler information providers.

### Some current technology options and strategies

ITS can be used to help address many work zone challenges and can take many forms in work zone applications. For example:

**Challenge:** Frequent but unpredictable congestion due to long-term or short-term lane closures.

**Potential application:** Benefits may be achieved from deploying a system that detects the onset of congestion, measures conditions on nearby alternate route(s), and automatically presents current travel times on the alternate and the current roadway to encourage diversion when appropriate. If alternate routes are not available, the work zone may benefit from an automatic queue detection warning system if the speed differential between approaching traffic and the traffic already in the queue is large.

**Challenge:** Reduced or eliminated emergency shoulders.

**Potential application:** Benefits may be achieved from an ITS deployment that focuses on incident detection, verification, and response within the work zone.

**Challenge:** Need for frequent direct access by construction vehicles and equipment to/from the travel lanes may result in conflicts with other road users, such as drivers following work vehicles into the work space or large speed differentials between motorists and construction vehicles entering the travel lanes from the work space.

**Potential application:** ITS could be used to notify motorists following a work vehicle that it will be entering the work zone and not to follow the construction vehicle, or to determine when the entrance of a construction vehicle is imminent and warn approaching motorists or direct them to change lanes or to stop.

**Challenge:** Agencies may impose penalties to contractors for creating excessive delays or queues during a project, but may not have the personnel available to monitor work activities continuously to verify compliance.

**Potential application:** Work zone ITS can be deployed to monitor and archive traffic conditions continuously, and the resulting data can be used when assessing liquidated damages or lane rental fees. Archived data can also be used to evaluate traffic control plan changes or even analyze and estimate impacts in future similar work zones.



Source: FHWA

Figure 2. Temporary, solar-powered vehicle detection and camera systems.

Table 1 provides a listing of common work zone ITS applications. It summarizes the components included in each application and provides a general indication of the safety and mobility issues the application attempts to address. As Table 1 suggests, many of the same ITS components are used in each application. Consequently, there are some overlaps in how systems can be designed and implemented to address specific work zone conditions. The differences between applications lie primarily in how the systems are designed to convey information to the motorist or traveler.

The applications presented in Table 1 may be deployed individually or be grouped together depending on the work zone. Ultimately, all of these applications seek to provide a more active management capability to the agency to achieve desired mobility and/or safety goals. Additional deployment examples have been documented in numerous case studies conducted by FHWA on work zone ITS.<sup>2</sup> As a part of this project, FHWA sponsored additional case studies to examine deployments of ITS in work zones in Effingham, Illinois; Mount Vernon, Illinois; Salt Lake City, Utah; Orem/Provo, Utah; and Las Vegas, Nevada in 2012.

<sup>2</sup> Additional information on these case studies can be found at: <http://www.ops.fhwa.dot.gov/wz/its>.

Table 1. Sample work zone ITS applications.

Work Zone ITS	Brief System Description	ITS Components	Issue(s) being Addressed	Example of Deployment
Real-time Traveler Information	Drivers provided information about current travel conditions; can be used to encourage diversion	<ul style="list-style-type: none"> <li>• Traffic data</li> <li>• Changeable Message Signs (CMS)</li> <li>• Communications</li> </ul>	<ul style="list-style-type: none"> <li>• Congestion/delay</li> <li>• Safety</li> <li>• Driver awareness</li> </ul>	For the I-15 Corridor Expansion (CORE) project, Utah DOT monitored travel times for I-15 and US-89 and posted current, comparative information on changeable message signs to reduce delays, stops, emissions, and the number and severity of traffic incidents. <a href="http://www.i15core.utah.gov/">http://www.i15core.utah.gov/</a>
Queue Warning	Signs provide warnings to drivers about stopped or slow traffic ahead	<ul style="list-style-type: none"> <li>• Traffic data</li> <li>• CMS</li> <li>• Communications</li> </ul>	<ul style="list-style-type: none"> <li>• Safety (crashes)</li> </ul>	For a large work zone on I-35, Texas DOT used sensors to detect the formation of queues and warn drivers of slowed or stopped traffic downstream via CMS. <a href="http://www.ops.fhwa.dot.gov/wz/resources/news/wznews_detail.asp?id=618">http://www.ops.fhwa.dot.gov/wz/resources/news/wznews_detail.asp?id=618</a>
Dynamic Lane Merge (early merge, late merge)	Signs encourage drivers to merge at a specified point based on current conditions	<ul style="list-style-type: none"> <li>• Traffic data</li> <li>• CMS</li> <li>• Communications</li> </ul>	<ul style="list-style-type: none"> <li>• Delay</li> <li>• Aggressive driving behavior</li> <li>• Safety</li> <li>• Queue length</li> </ul>	Dynamic lane merge systems on I-95 and evaluated by Florida DOT have shown potential to enhance safety and operations. <a href="http://www.dot.state.fl.us/research-center/Completed_Proj/Summary_CN/FDOT_BD548-24_rpt.pdf">http://www.dot.state.fl.us/research-center/Completed_Proj/Summary_CN/FDOT_BD548-24_rpt.pdf</a>
Incident Management	Enables faster detection of incidents for quicker response and clearance time	<ul style="list-style-type: none"> <li>• Cameras</li> <li>• Traffic data</li> <li>• Communications</li> <li>• CMS</li> </ul>	<ul style="list-style-type: none"> <li>• Incident response and clearance time</li> <li>• Delay</li> <li>• Secondary crashes</li> </ul>	The Big I project in New Mexico incorporated an incident management system to provide accurate information, support quick identification of incidents, and help to manage area traffic. <a href="http://www.ops.fhwa.dot.gov/wz/technologies/albuquerque/index.htm">http://www.ops.fhwa.dot.gov/wz/technologies/albuquerque/index.htm</a>
Variable Speed Limits (VSL)	Can provide speed harmonization and calm traffic for slow or stopped traffic ahead	<ul style="list-style-type: none"> <li>• VSL CMS</li> <li>• Traffic data</li> <li>• Communications</li> </ul>	<ul style="list-style-type: none"> <li>• Speed management</li> <li>• Safety</li> </ul>	In 2008, VSL signs were used by Utah DOT in a work zone on I-80 and by Virginia DOT on the I-495/I-95 Capital Beltway. ( <a href="http://www.udot.utah.gov/main/uconowner.gf?n=7828313631638132">http://www.udot.utah.gov/main/uconowner.gf?n=7828313631638132</a> , <a href="http://www.virginiadot.org/vtrc/main/online_reports/pdf/10-r20.pdf">http://www.virginiadot.org/vtrc/main/online_reports/pdf/10-r20.pdf</a> )
Automated Enforcement	Automated system detects and captures images of speeding vehicles for enforcement purposes	<ul style="list-style-type: none"> <li>• Cameras</li> <li>• Radar</li> <li>• Communications</li> </ul>	<ul style="list-style-type: none"> <li>• Speed management</li> <li>• Safety of law enforcement personnel</li> </ul>	Some states utilize speed-radar photo enforcement in work zones, including Illinois, which uses vans with retrofitted equipment to reduce speeds through work zones and work zone fatalities. <a href="http://onlinepubs.trb.org/onlinepubs/trnews/trnews277tpo.pdf">http://onlinepubs.trb.org/onlinepubs/trnews/trnews277tpo.pdf</a> .
Entering/exiting vehicle notification	Signs can warn drivers of a slow-moving construction or emergency vehicle entering or exiting the roadway	<ul style="list-style-type: none"> <li>• Sensors</li> <li>• CMS</li> <li>• Communications</li> </ul>	<ul style="list-style-type: none"> <li>• Safety</li> </ul>	Pennsylvania DOT used an innovative system for a unique problem involving emergency vehicle access. The system utilized siren-activated pre-emption technology on emergency vehicles to activate CMS alerting oncoming vehicles that a slow-moving emergency vehicle would be entering the roadway. <a href="http://www.roadsbridges.com/case-fire">http://www.roadsbridges.com/case-fire</a>
Performance Measurement	Monitor and archive traffic conditions data to support real-time traveler information, modify operations, and support evaluation.	<ul style="list-style-type: none"> <li>• Sensors</li> <li>• Communications</li> <li>• Archive database</li> </ul>	<ul style="list-style-type: none"> <li>• Congestion/delay</li> <li>• Safety</li> <li>• Evaluation</li> </ul>	Both Ohio and Indiana DOTs have established policies on acceptable work zone queue length and duration. Work zone ITS can monitor and archive traffic data that can be used to evaluate performance measures, including those used in performance-based contracting.

Source: Battelle

## Benefits that are possible with work zone ITS

ITS work zone systems have the capability to provide significant benefits to agencies and to those affected by the mobility and safety impacts of road construction and maintenance work zones. Many agencies have already begun to experience benefits and to pass those experiences on to others. In general terms, potential benefit impact areas associated with the use of ITS in work zones are as follows:

- **Safety** – ITS can help to minimize the consequences of work zones on both traveler and worker safety. Credible warnings of the presence of unexpected queues, notification and reassurance of travel times to reduce driver stress, and credible warnings of construction vehicle access and egress are examples of how work zone ITS can improve the safety of both travelers and workers. Systems that automatically adjust the speed limit of the work zone to current conditions, automate enforcement of traffic laws, or help to quickly identify when incidents have occurred in work zones can also significantly improve safety. For example, the use of an incident management system in a New Mexico work zone reduced average incident clearance time by 20 minutes and is believed to have reduced the frequency of secondary crashes.<sup>3</sup>
  - **Mobility** – Reduced travel time delay is a primary benefit of many work zone ITS applications. Travelers making adjustments to their route, departure time, or mode choices based on information provided by ITS, or the use of alternate traffic management practices (e.g., dynamic lane merging, VSL) via ITS can reduce delay. For example, real-time traveler information induced up to 19% diversion away from a route with a work zone in California.<sup>3</sup> These adjustments benefit not only those travelers who made changes to their trips, but others who continued to travel through the work zone. Mobility benefits will be especially high on facilities that serve a large amount of commercial vehicle traffic, as the value of commercial vehicle travel time is very high.
  - **Improved work productivity and durability** – Work zone ITS can also improve agency and contractor productivity and efficiency, ultimately reducing the number of days that the work zone is present and reducing contractor operating costs. Reduced congestion and improved mobility can allow the contractor to use fewer trucks to bring materials
- into the work space during certain work operations. Better control over material delivery time can result in more durable, high-quality construction. Real-time monitoring of traffic volumes can allow agencies and contractors to initiate lane closure activities as soon as conditions will allow each day or night, rather than wait for a prescribed time that is typically based on a worst-case estimate of traffic demands. Further, the use of ITS in and around work zones can allow for the automation of functions that would normally have to be performed manually by agency personnel. For example, work zone ITS can be deployed to monitor and archive traffic conditions continuously, and the resulting data can assist agencies in imposing penalties on contractors for creating excessive delays or queues during a project. Archived data from work zone ITS can also be used to evaluate traffic control plan changes or analyze and estimate impacts in future similar work zones.
- **Customer satisfaction** – Information gathered and provided by work zone ITS can lead to increased customer satisfaction. ITS allows agencies to update motorists about changes in traffic conditions in the same fashion they occur—in real time. The relative ease of relaying information to the media, websites, social media, and phone applications can enable more frequent updates, as well as wider access to this information. To improve customer satisfaction by reducing delay, a project in Utah used an advanced traffic management system to monitor traffic and post comparative travel time information on CMS, as shown in Figure 3.<sup>3</sup> On the CMS, an arrow to the left indicated the travel time to Lehi using I-15 (accessible to the left) and an arrow pointing ahead indicated the travel time via an alternate route (State Street). In Little Rock, Arkansas, 82 percent of drivers surveyed agreed that an Automated Work Zone Information System improved their ability to react to slow or stopped traffic.<sup>4</sup> Awareness of real-time work zone conditions can improve the favorable perception of the agency to travelers, business owners, residents, and users within the agency.

## Purpose and organization of this document

The purpose of this document is to provide guidance on implementing ITS in work zones to assist public agencies, design and construction firms, and industry, including developers, manufacturers, distributors, packagers, and providers of devices, systems, and programs. Work zone ITS is one possible operational strategy of many potential

<sup>3</sup>For more information and other examples, see: <http://www.ops.fhwa.dot.gov/wz/its>

<sup>4</sup>Additional information can be found at: <http://www.itsbenefits.its.dot.gov/ITS/benecost.nsf/ID/76C9F2DE2BF5DB1D85257603004E031D?OpenDocument&Query=Home>.





Source: FHWA

**Figure 3. Sequencing comparative travel time sign at a decision point for two different routes to the town of Lehi that was used for a project in Utah.**

process should be applied to determine the feasibility and design of work zone ITS for a given application by walking through the key phases, from project concept through operation. In addition, the guide discusses evaluating the effectiveness of the system in achieving stakeholder goals (an important but often overlooked activity).

The guide identifies where and how existing regional and statewide ITS architectures should be considered for consistency and interoperability with currently deployed ITS elements, especially when the systems will become part of a permanent deployment.<sup>6</sup>

solutions that an agency can include in a transportation management plan (TMP). A TMP, as required by the work zone Safety and Mobility Rule<sup>5</sup>, lays out a set of work zone management strategies—work zone traffic control, public information and outreach, transportation operations—that the agency will use to manage the impacts of a particular road project. Considering whether to deploy work zone ITS on a project and designing and deploying a system should be done as part of work zone impacts assessment and TMP development and implementation.

This document is organized into chapters corresponding to the steps in the development and implementation process, which are shown in Figure 4. Each chapter addresses the challenges and barriers that agencies may face in deploying ITS applications. Lessons learned are included where appropriate (and compiled in Appendix C), to provide information on how other agencies have overcome these challenges and potential barriers.

This document summarizes key steps for implementing ITS in work zones. Successful implementation of ITS applications in work zones requires a systematic approach to provide a technical solution that accomplishes a specific set of clearly defined objectives. The document illustrates how a systems engineering

This document is intended to guide users through the deployment of any work zone ITS, regardless of its scale. Although the overall scope of the envisioned project will ultimately determine the complexity and level of effort required during planning, the steps included in this document should apply equally to the range of deployments, from small-scale, temporary deployments lasting a few months to complex, multi-year ITS deployments that may eventually be incorporated into permanent traffic monitoring and management systems.

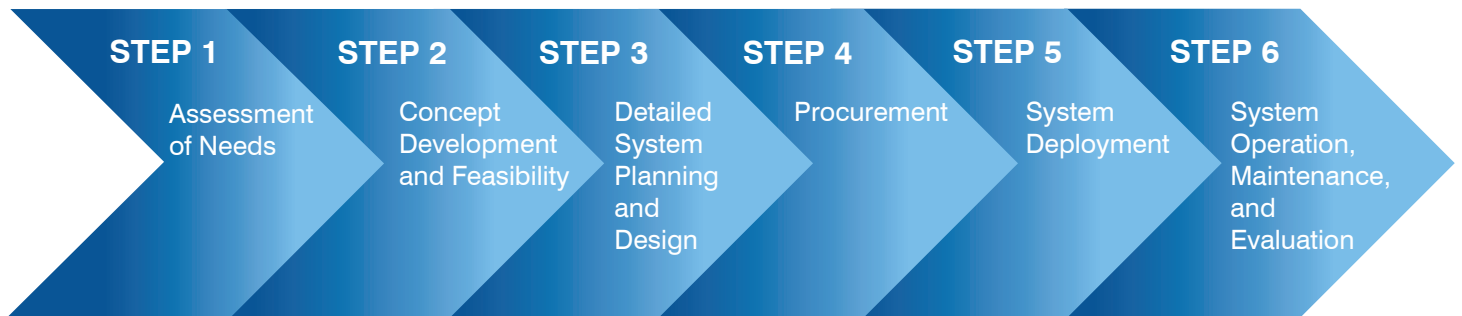

**Figure 4. Overview of the implementation process.**

Source: Battelle

<sup>5</sup> More information on the Rule (23 CFR 630 Subpart J) is available at: [http://www.ops.fhwa.dot.gov/wz/resources/final\\_rule.htm](http://www.ops.fhwa.dot.gov/wz/resources/final_rule.htm)

<sup>6</sup> More information on ITS architecture is available at: [http://ops.fhwa.dot.gov/its\\_arch\\_imp](http://ops.fhwa.dot.gov/its_arch_imp).







This section describes key activities or considerations that should be addressed in Step 1 of the implementation process, in which the work zone needs are established and preliminary information is gathered. The sub-steps that will be explored in Step 1 are depicted in Figure 5.

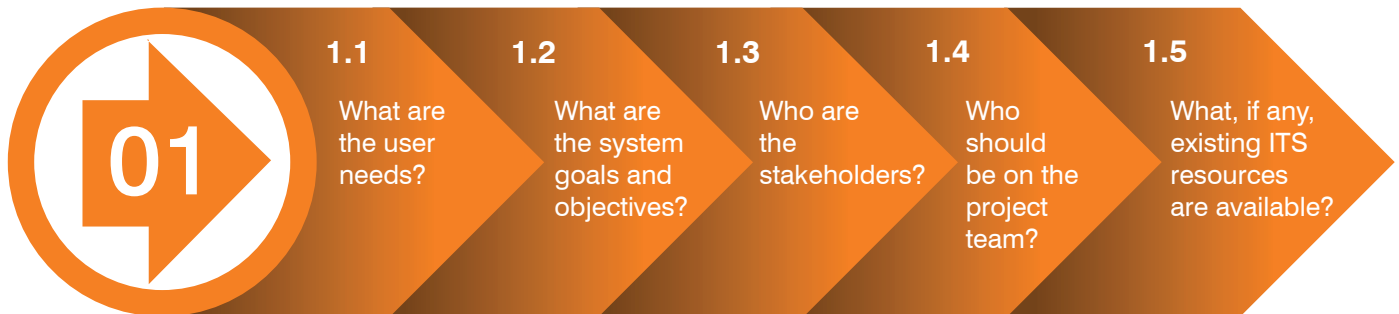

Figure 5. Sub-steps to be explored in Step 1.

Source: Battelle

**1.1 What are the user needs?**

Users are those who will use and directly benefit from the outputs of the work zone ITS system. Most often, user needs are in reference to travelers, but user needs may also be identified for the agency or contractor. Each work zone presents different challenges and unique circumstances that affect user needs. Table 2 provides examples of some of the issues that may be encountered in a work zone and need to be addressed.

The first sub-step in Step 1 is to determine what issues/needs exist for the work zone. This should be performed in the context of an overall assessment of the expected impacts of the work zone, and in coordination with the transportation management plan (TMP) development process for the work zone.<sup>7</sup> This larger perspective is important because there may be more than one TMP strategy that can address the need, and work zone ITS may not be the best alternative to mitigate these issues. Determining the user needs first will help an agency better decide whether work zone ITS will adequately address the problem at hand and if it is the most suitable solution. Work zone ITS should be intentionally applied as a carefully designed solution to a well-defined problem.

<sup>7</sup> More information on work zone impacts assessment and TMP development is available at [http://www.ops.fhwa.dot.gov/wz/resources/final\\_rule/guidance.htm](http://www.ops.fhwa.dot.gov/wz/resources/final_rule/guidance.htm).



### Example: McClugage Bridge rehabilitation, Peoria, Illinois.

This project provides an example of the importance and value of considering user needs early in the work zone planning process. The McClugage Bridge consists of two independent spans, each serving one direction of US 24/US 150 travel through Peoria and across the Illinois River. During the rehabilitation effort, the eastbound span of the bridge was closed completely, and traffic in both directions of travel was placed on the westbound span. The Illinois DOT and the contractor elected to use both a movable barrier system and work zone ITS to try to address mobility problems expected from the bridge closure. However, officials found that the movable barrier provided sufficient peak period and peak direction capacity through the work zone that the congestion that was feared never materialized. As a result, the work zone ITS never had to be activated during the project.

Not all user needs will automatically imply that work zone ITS is required. Analysis in subsequent steps of concept development may indicate that some other approach to mitigating the problem to address the user need is more appropriate, or may verify that the work zone ITS solution is needed. In this example, greater consideration of the effect of the moveable barrier may have indicated that there was not a significant user need to warn approaching traffic about travel conditions, such as stopped traffic.

Satterfield, C. Moveable Barrier Solves Work Zone Dilemma. In *Public Roads*, Vol. 65, No. 1, July/August 2001, pp. 26-29. Accessible at: <http://www.fhwa.dot.gov/publications/publicroads/01julaug/workzone.cfm>.

Table 2. Examples of site-specific issues and problems.

#### Examples of mobility issues or problems:

- Long-term capacity reductions will create daily peak-period delays.
- A contractor is managing material deliveries from the batch plant to the job site and needs to know when and how much the travel time between the two locations is changing over time because of congestion.
- Loss of shoulders will make effects of incidents more severe and longer-lasting. Ability of emergency services to reach incidents will be hampered.
- Geometric constraints upstream of the project will make it critical to minimize queue lengths due to any lane closures.
- Ridesharing and transit users during the project need to be given a travel time advantage to promote mode shift.
- Off-peak short-term lanes closures will create unexpected queues, and significant diversion is needed to keep queues at reasonable lengths.

#### Examples of safety issues or problems:

- Nighttime lane closures will create queues and large-speed differentials, increasing rear-end crash risk.
- Constrained geometrics are likely to necessitate a reduced speed limit through the project, but those constraints will make enforcement of the reduced speed limit very difficult.

#### Examples of productivity issues or problems:

- Haul vehicle difficulties to access and egress the work space will delay material deliveries, and increase the number of vehicles required to support work tasks.
- A contractor is managing material deliveries from the batch plant to the job site and needs to know when and how much the travel time between the two locations is changing over time because of congestion.

Source: FHWA

When identifying and describing the user needs for a particular project, it is important to be as specific as possible. For example, the Illinois DOT identified unexpected queue formation at work zones in semi-rural areas as a concern. They specified that these concerns existed whenever a temporary lane closure or long-term road closure was required, and whenever a vehicle stall might occur (because of a lack of emergency shoulders to move the vehicle out of travel lanes). Trying to reduce the effects of unexpected queues, coupled with the unpredictability of the events causing those queues, was the specific user need to be addressed. Similarly, the Texas DOT also had a user need to reduce the effects of unexpected queues during construction projects along I-35. However, in defining their needs they also desired to minimize the amount of equipment deployed within each of the several projects that were ongoing simultaneously along the 90+ mile corridor. They also wanted to be able to accurately detect and measure the length of queue that developed at each temporary lane closure installed so that forecasts of delay impacts from the closure could be disseminated to motorists farther upstream. Thus, their specific user needs were somewhat different from those of Illinois DOT, even though both were concerned about the same general issue.

Another consideration are regulatory requirements or agency policies associated with monitoring and assessing the impacts of a work zone. For example, an agency's policy may limit work zone delays to 20 minutes. Work zone ITS can be used to monitor if a work zone is meeting the agency's target. 23 CFR Subpart C (sometimes referred to as the 1201 rule from the SAFETEA-LU Highway Authorization Act of the 109th U.S. Congress)<sup>8</sup> establishes minimum requirements for agencies for real-time information, including work zone lane closure information for long-term construction projects. The Work Zone Safety and Mobility Rule (23 CFR 630 Subpart J) requires agencies to use work zone safety and operational data to improve projects and agency policies, processes, and procedures regarding work zone safety and mobility management. Work zone ITS is one of the possible ways to gather data for use in assessing work zone performance.

## 1.2 What are the system goals and objectives?

An agency must clearly articulate its goals at the outset of the project to best ensure deployment of a system that will satisfy those objectives. Although general goals or objectives for the system may be stated as

agency policy, it is the responsibility of staff engineers and planners to translate general goals into specific, measurable, and, most importantly, attainable objectives for the project and the work zone ITS (e.g., no more than 20-minute delays or 2-mile queues). The goals and objectives should address user needs identified in Step 1.1 and through impacts assessment, and also support TMP development. System goals and objectives should also follow SMART criteria, meaning that they are Specific, Measurable, Attainable, Relevant, and Time-bound. The key factor in this step is to set realistic objectives for the system and avoid the creation of unrealistic expectations that result in diminished credibility in the system's outputs. In other words, if a work zone ITS would be deployed, what would it do to address user needs?

Those engaged in the goal-setting process should periodically check to ensure that goals or objectives have corresponding means of measurement. In other words, how will success of a system be measured during and after it is deployed? It will be important to match data availability and/or processing capabilities of the system with the desired goals and objectives. For example, if a queue length threshold is established for the project, the system should be capable of providing reasonable queue length estimates. Conversely, if delay is the desired metric, a system that directly measures travel time and delays might be more appropriate.

In general, the system should be adequately robust to consider the full impact of the work zone. As shown in Figure 6, for example, the area of ITS influence due to a work zone may include adjacent routes. It is likely that at least some drivers will divert, regardless of whether messages encourage taking an alternate route. This additional traffic may cause congestion on those adjacent routes and should be considered when planning for the ITS. If diversion is expected, ITS devices may be required on alternate routes as well as the mainline. These alternate routes will need to be monitored and managed in order for benefits to be achieved. While the ITS zone on the mainline may extend upstream from the work zone beyond the length of the expected queue (e.g., a queue warning system), and perhaps upstream from a diversion point (e.g., real-time travel information system with comparative travel times or suggesting alternate routes), ITS could also be considered on alternate routes that could be impacted. The FHWA report "Advancing Metropolitan Planning for Operations: The Building Blocks of a Model Transportation Plan Incorporating Operations – A Desk Reference" may serve as a useful guide for this step.<sup>9</sup>

<sup>8</sup> The text of Section 511.309 can be found at: <http://ecfr.gpoaccess.gov/cgi/t/text/text-idx?c=ecfr&sid=66686edfa10d4ace67b3e67bbc442ef7&rgn=div5&view=text&n ode=23:1.0.1.6.16&idno=23>.

<sup>9</sup> Available at: <http://www.ops.fhwa.dot.gov/publications/fhwahop10027/>

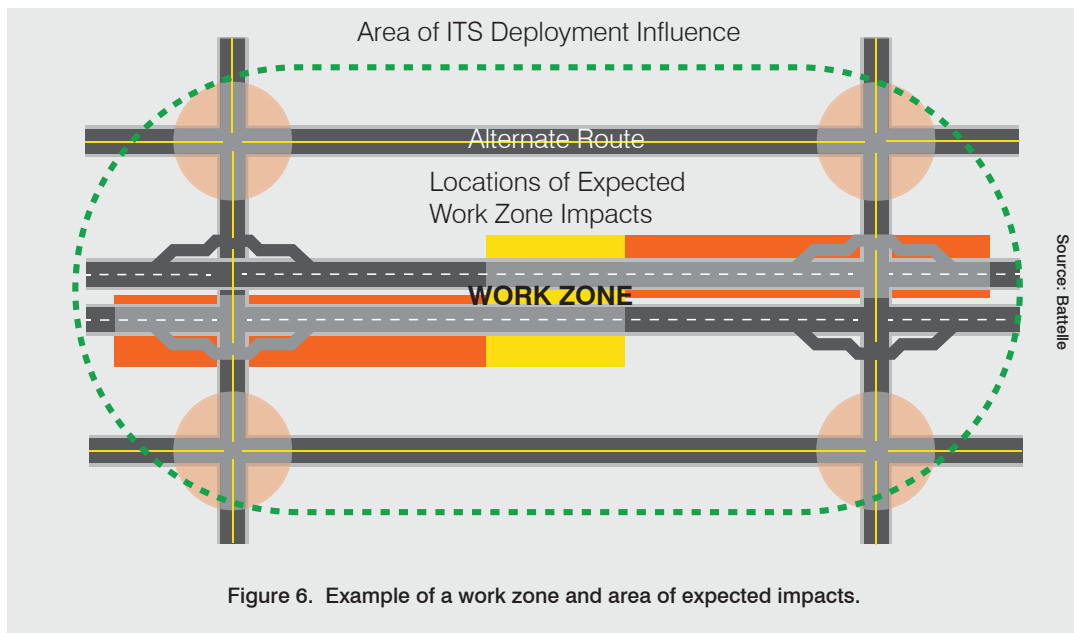

Figure 6. Example of a work zone and area of expected impacts.



**Key point: Work zone ITS is one of several tools available to address specific safety and mobility issues in work zones.**

If goals and objectives become more manageable to achieve through a different technique, that technique should be selected instead of ITS. Other strategies may be more economical and effective in meeting goals and objectives



**Tip: Have realistic expectations.**

Although some ITS applications may be promoted as a catch-all solution to safety and capacity problems, field testing has not always shown conclusive benefits. Work zone ITS should be well designed and smartly applied to scenarios in which benefits are most likely to be achieved.



**Tip: Be sure that the work zone ITS fully captures the range of impacts for which it is intended.**

This is particularly important for deployments that are intended to convey delay or queue length information to users. In some deployments, work zone impacts periodically extended beyond the limits of the ITS devices. When this happened, the system was unable to provide accurate information. More importantly, the motorists sat through several minutes of delay before encountering a message that there were delays and reduced speeds in the work zone. This severely limited the credibility, usefulness, and benefits of the system.

### 1.3 Who are the stakeholders?

Stakeholders should be engaged early in the project development process to ensure that a full range of possibilities can be considered. Stakeholders include any person or organization that may be affected by construction, and all agencies that are directly involved with motorist assistance, law enforcement, and providing traveler information. Stakeholders are a broader group than users, and include those who are not intended to be primary users of an ITS deployment. Potential stakeholders include:

- State DOT (including those with ITS expertise)
- City transportation agencies
- Metropolitan Planning Organizations
- County transportation agencies
- FHWA Division Office
- Service patrol/contractors
- Construction contractors
- State and local police departments
- Fire departments
- Emergency medical services
- Local businesses
- Shopping centers and other major traffic generators
- Major commercial trucking companies
- Motorists
- Media
- Residents
- Public officials
- Other incident management agencies.

Stakeholders should include policy makers, as well as staff from agencies involved in the deployment, operation, and maintenance of both the work zone and the ITS application. Although not all of these groups may have a direct interest in all of the project's objectives, they may be able to offer valuable insight that expands the original vision to achieve greater benefits.

If the project is within an area that has already developed a regional ITS architecture, many of the stakeholders would have already been identified. This would be a good place to start to establish a core team to further define the system concept. This group can also help identify other potential work zone information sharing opportunities between jurisdictions and agencies.

Stakeholders must be involved early on for a successful ITS implementation. Input from these groups can result in better deployment plans. It is unlikely, especially for smaller projects, that stakeholders will convene for a meeting solely about ITS; instead discussion regarding ITS will likely be part of a larger agenda, such as on the TMP or the project alternatives and schedule. It is important to ensure that ITS is included on this larger agenda to help stakeholders understand the possible deployment and gain their input and support. Smaller working groups should be developed and convened regularly to keep all stakeholders informed about the progress of an ITS deployment. The goals of such a working group should include keeping stakeholders informed, creating opportunities for input and participation, providing feedback, creating an informed consensus, and identifying the need for system adjustments during deployment. Working group discussions might be combined with related meetings such as those on maintenance of traffic.

Stakeholders need to have input in developing the goals and objectives of the implementation and should review strategies and plans to make sure their needs are being met to the fullest extent possible. Ideally, this input will be gathered as part of the project impacts assessment and TMP development process to support an efficient and coordinated process for work zone management. Stakeholders should review critical steps in system development and should be influential when decisions are being made.



**Tip: Stakeholder agencies, besides the deploying agency, need to be involved early.**

Coordination with other agencies is a primary issue that should be considered both in developing and implementing an ITS work zone. This will be important for determining how the system can work within each agency's existing procedures.



**Example: I-15 CORE Project in Utah.**

Utah DOT traffic operations personnel were incorporated early in the project planning process and strived to be proactive in addressing the various mobility concerns that could develop. During the planning process, it became apparent that it would be extremely beneficial to upgrade the arterial signal systems in Provo and Orem to become compatible with the Utah DOT centralized signal system. Utah DOT approached the cities of Provo and Orem and established cooperative agreements to convert their systems to the statewide signal control system in order to better manage travel on the arterial streets adjacent to the freeway.



### 1.4 Who should be on the project team?

The next step is to assemble the project team. The project team is the actual working group whose members are drawn from the stakeholder organizations identified in the previous step. It is recommended that the number of people on this team be small because this team will be conceptualizing and planning the project. While it is important to involve a wide range of stakeholders from the very beginning of the project, it is also important to keep working groups small so that these groups can actually get things done. Thus, not all stakeholders will have a representative on the project team. Instead, the project team will be responsible for interfacing with stakeholders that are not on the project team to keep them informed and receive their input. In addition, it is also important not to expect that all stakeholders will be fully “sold” on the project at first. Instead, the lead agency must have patience with “non-believers,” allowing them time to develop trust in the system, as well as trust in other groups involved in the project.

### 1.5 What, if any, existing ITS resources are available?

Taking an inventory of existing ITS resources in the corridor or region that can be applied to help manage the work zone can help to control system acquisition and deployment costs. For example, there may be a permanent traffic detector within or adjacent to the work zone that can provide archived or real-time data to help predict and/or monitor traffic conditions

leading up to and throughout the work zone. There may be permanent CMS upstream of the work zone that can display warnings of stopped or slow traffic ahead or encourage diversion to alternate routes, as presented in Figure 7. Closed-circuit television (CCTV) cameras in the area might also be particularly useful for helping to monitor traffic and check for incidents. Any road weather information systems (RWIS)/environmental sensor stations (ESS) in the area can help determine current weather and road conditions that will affect traffic flow. Additionally, the availability of a local traffic management center (TMC) can be very beneficial, as staff could operate ITS for the work zone. An existing traveler information website for the agency or geographic area can be used to provide updates on work zone conditions to the public.

The maintaining agency for these resources can explain the availability of ITS resources for use. For example, CMS may be needed for emergency messages, or it may not be preferred that a message is displayed for all hours due to concerns of burning out the lighting mechanisms and long term maintenance costs. Discussions about stakeholders concerns may result in some creative solutions, such as agreement to place messages on during peak hours of travel.

If existing ITS resources are available and are planned to be used for work zone management purposes, care must be taken to ensure that the resources themselves will remain operational over the duration of the project



Colorado DOT

Figure 7. Existing ITS resources can be used to help manage the work zone and reduce costs.



and access to the systems and data is readily available. The need to temporarily disconnect power or communication lines in the work zone may render permanent ITS devices near the work zone inoperable or inaccessible, or they may even be removed if they are directly in the work area. Construction equipment or vehicles have the potential to block sensors or cameras unexpectedly and repeatedly. To avoid such issues, some agencies include requirements in the bid documents that permanent ITS devices be maintained in an operational state throughout the duration of the project. Agencies may also include disincentive clauses in a contract that are applied if the ITS equipment does not work during peak hours. Functionality of ITS equipment is particularly important in congested areas where the television, radio, and/or social media traffic updates rely on information from the ITS equipment.

In some cases, it may be desirable to mesh or replace available ITS resources with additional temporary devices obtained specifically for a particular work zone. An example of this might be the purchase and installation of portable traffic sensors, cameras, and CMS within and near a work zone on a facility that is not currently covered in a regional ITS, and having the operators within the TMC monitor and manage those temporary devices in addition to the permanent ITS components they normally operate. In such instances, it is important to bring the key decision-making personnel from the center in early in the planning process to help identify needs and issues. The center may need to increase staff to handle the increased workload, for example, and need financial support through the project budget to do so. There will likely be specifications as to how temporary devices must be configured and operated (i.e., National Transportation Communications for ITS Protocol (NTCIP)-compliant cameras) in order to integrate data feeds into the operator consoles.



#### Example: Use of Permanent ITS Infrastructure during Construction.

- I-15 CORE Project in Utah. When Utah DOT officials determined that I-15 needed to be widened through the cities of Orem and Provo, they enlisted the regional ITS center in Salt Lake City to assist in managing traffic during construction. A number of value-added items were proposed by the winning design-build (DB) team that centered around the enhancement of the existing system. System officials worked closely with the DB team and with Utah DOT project officials to coordinate the purchase, implementation, and integration of technology at critical locations to help mitigate project impacts. In addition, system officials identified other components that were needed in the region to help support traffic management during construction, and that could also be useful additions to the system once construction was complete. These components were procured and installed in time to be useful for the construction project.
- Las Vegas. The Freeway and Arterial System for Transportation (FAST) is a transportation management system in Las Vegas. FAST operators have a fairly wide range of tools at their disposal to help address construction and maintenance activity-related impacts. FAST provides a convenient dissemination outlet of both advance notification and real-time roadwork-related traffic information via the roadside CMS and its website. FAST operators are trained to both identify the need for CMS messages and to properly design and post them. For certain roadwork activities, FAST operators may also make signal timing changes to support use of arterials as detour routes if either the freeway or another arterial is affected by

#### Key Takeaways

- Plan with the end in mind. Start with identifying work zone issues and user needs, and what the goals are for the work zone. Then consider possible solutions/strategies, including ITS, that can address those needs.
- Use a coordinated approach. Consider work zone issues, needs, and possible mitigation strategies in the context of overall impacts assessment and TMP development for the work zone to most effectively address issues and use resources.
- The main product of Step 1 is a preliminary framework of user needs, goals and objectives, and existing ITS resources in the area around which ITS or some other solution for the work zone can be developed. These outputs will be used in Step 2 for the development of a concept of operations.
- Additionally, stakeholders and a project team have been identified in Step 1, who will respectively provide periodic feedback and more direct input to the project moving forward.





This section describes key activities or considerations that should be addressed in Step 2 of the implementation process, in which a system concept for the ITS deployment is developed. The sub-steps that will be explored in Step 2 are depicted in Figure 8.

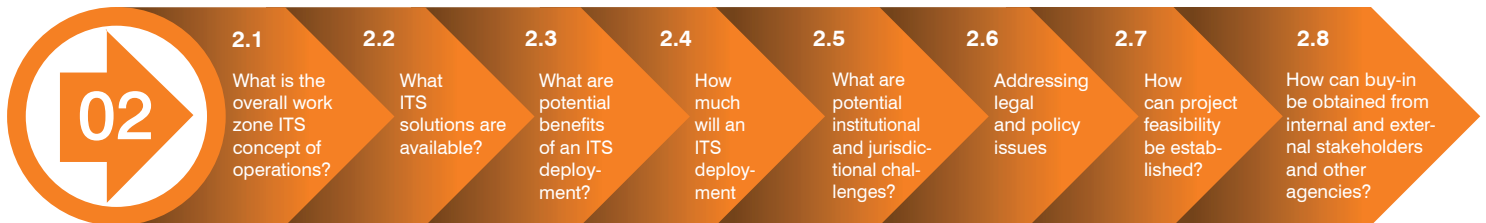

Figure 8. Sub-steps to be explored in Step 2.

Source: Battelle

### 2.1 What is the overall work zone ITS concept of operations?

The development of a work zone ITS concept of operations should take place in the early stages of the planning process. It should answer the question, how does the agency envision that the system will operate within the work zone? A concept of operations includes user needs and objectives that were developed in Step 1, as well as justification for and description of the proposed system, operational policies and constraints that will govern how the system is deployed, and scenarios describing how the system will function. Developing a concept of operations helps ensure the agency has thought through what it needs out of the system, which generally leads to a more successful work zone ITS deployment. Figure 9 shows the general

outline of a formal concept of operations document based on the Institute of Electrical and Electronics Engineers (IEEE) 1362-1998 standard document. For a small work zone ITS deployment, the developed concept of operations document may be significantly scaled back, as seen in a concept of operations developed for a Minnesota DOT work zone ITS deployment.<sup>10</sup>

Even though a concept of operations starts to formalize the type of system that is envisioned, it is important to note that this document is solution-agnostic, describing how the system will operate but not prescribing the technology components to be installed. For example, a concept of operations should not dictate whether radar or video detection should be used, even if in some situations there may be only one viable alternative that exists.

<sup>10</sup> Document can be found at: [http://www.dot.state.mn.us/guidestar/2006\\_2010/icone/iconeconceptofops.pdf](http://www.dot.state.mn.us/guidestar/2006_2010/icone/iconeconceptofops.pdf)

<b>1. SCOPE</b>
1.1 Identification 1.2 Document Overview 1.3 System Overview
<b>2. REFERENCED DOCUMENTS</b>
<b>3. CURRENT SYSTEM OR SITUATION</b>
3.1 Background, Objectives, and Scope 3.2 Operational Policies and Constraints 3.3 Description of the Current System or Situation 3.4 Modes of Operation for the Current System or Situation 3.5 User Classes and Other Involved Personnel 3.6 Support Environment
<b>4. JUSTIFICATION FOR AND NATURE OF CHANGES</b>
4.1 Justification for Changes 4.2 Description of Desired Changes 4.3 Priorities among changes 4.4 Changes Considered but not Included 4.5 Assumptions and Constraints
<b>5. CONCEPTS FOR THE PROPOSED SYSTEM</b>
5.1 Background, Objectives, and Scope 5.2 Operational Policies and Constraints 5.3 Descriptions of the Proposed System 5.4 Modes of Operation 5.5 User Classes and other Involved Personnel 5.6 Support Environment
<b>6. OPERATIONAL SCENARIOS</b>
<b>7. SUMMARY OF IMPACTS</b>
7.1 Operational Impacts 7.2 Organizational Impacts 7.3 Impacts During Development
<b>8. ANALYSIS OF THE PROPOSED SYSTEM</b>
8.1 Summary of Improvements 8.2 Disadvantages and Limitations 8.3 Alternatives and Trade-offs Considered
<b>9. NOTES</b>
9.1 Acronyms and Abbreviations 9.2 Terms and Definitions

Figure 9. General outline showing the sections of a formal concept of operations document based on the IEEE 1362-1998 standard.

The concept of operations should clearly describe all activities associated with operation of the system, from the data flows between system components to information flows between the agency and the public. Creation of data flow diagrams, information flow diagrams, and communication charts can be valuable in helping agency staff define how the system will ultimately operate, as well as in guiding decisions affecting the overall strategy for the system. An example graphic that could be used to help staff visualize the layout of the ITS deployment is shown in Figure 10. Potential strategies can vary from simple automated systems that provide traveler information upstream of the work zone to systems that serve as virtual TMCs.

Agency staff should clearly describe the operational system strategy at the outset of the project, with particular attention to how this strategy will fit within their overall construction project. In addition, the concept of operations for the ITS deployment should make sense in the context of the existing roadway network. For example, if CMS will be used to provide messages about delay or stopped traffic ahead, it would make sense to place the signs prior to exits to alternative routes. The concept of operations can be a working document during planning stages, and can be updated as needs change and system functionality is considered. The concept of operations can also include multiple subsystems, e.g., a queue warning system, incident detection system, and VSL system.

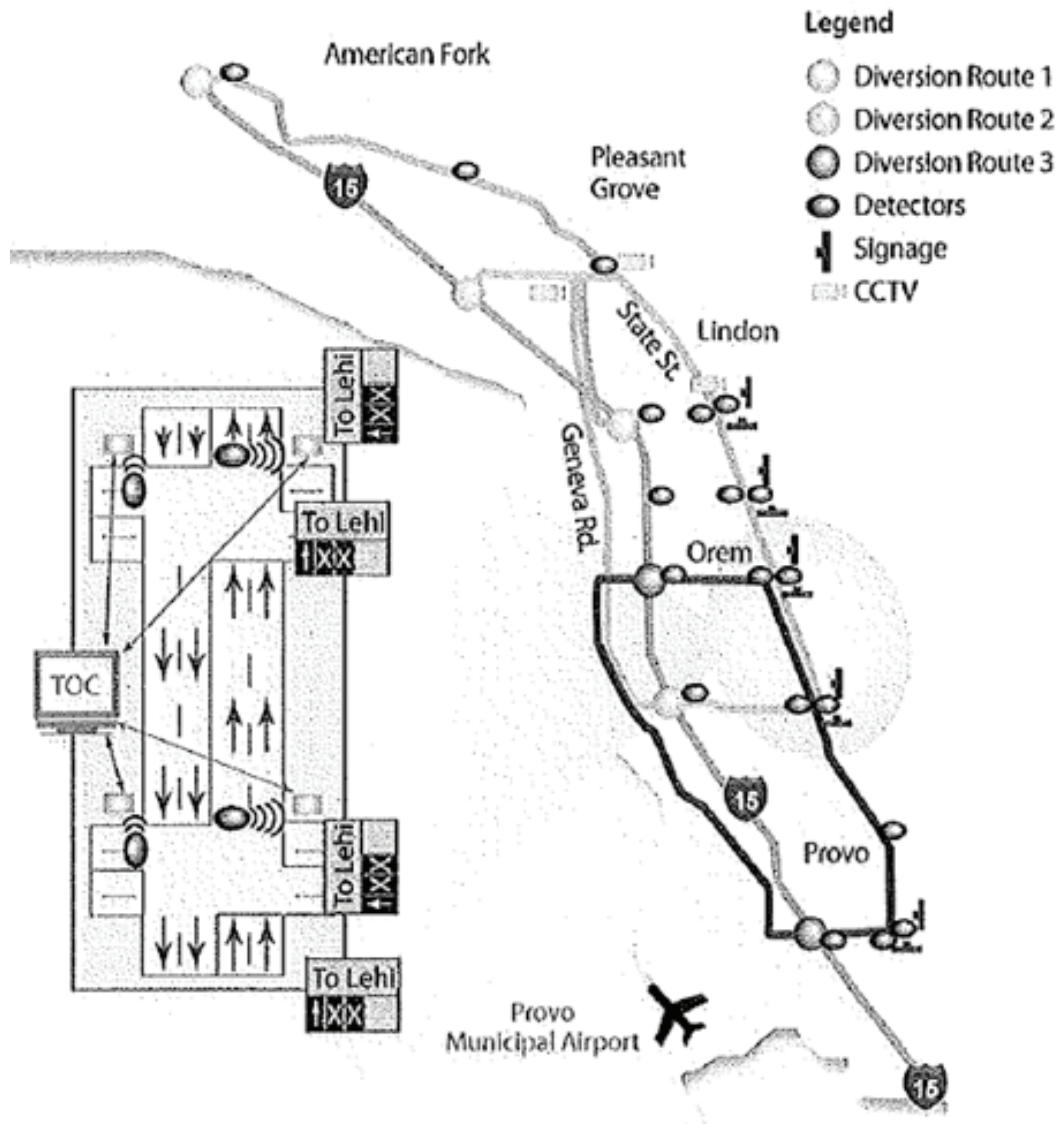

Figure 10. High-level sketch for the concept of operations of a work zone ITS deployment in Utah. Source: Utah DOT.

**! Key point: Not all ITS deployments are complicated and expensive.**

For example, an additional temporary traffic sensor or two may be all that is needed to expand or enhance an existing permanent ITS deployment to be an effective tool for managing traffic impacts at a particular work zone. This was the approach taken during the I-15 CORE project in central Utah.

### 2.2 What ITS solutions are available?

ITS technology is one tool that can be used by agencies and contractors to address a wide range of concerns or needs in a work zone. Systems can vary widely based on concerns being addressed. They also vary in scale. Not all ITS deployments are complicated and expensive.

ITS can take many forms in work zone applications. In general terms, these systems are comprised of components in the field, communications links, a TMC, and/or archived data. The National ITS Architecture provides a framework for planning, designing, and integrating ITS components.<sup>11</sup> Additionally, permanent ITS applications may already be in place in part of the work zone area, and may be useful as components for work zone ITS. More specifically, systems include one or more of the following components, which are detailed in Table 3:

- Sensors that collect data on current traffic conditions
- Communications equipment to transfer the data or information developed from that data

- Software that processes and analyzes the collected data, as well as available supplemental (e.g., weather data or traffic data from alternate routes) and archived data (e.g., historic traffic data), converting it to information for use by other components or by various end users
- Electronic equipment to disseminate the information to the end users or to implement traffic control or management decisions that were based on that information.

These systems are available in a variety of configurations. These configurations can impact the procurement options that are available to an agency, which will be discussed in more detail in Step 4 of the document. In general, the three main categories of ITS are:

- Stand-alone, commercial off-the-shelf (COTS) products to serve specific functions (i.e., smart work zone systems that can perform queue warning, travel time and delay information dissemination, dynamic late or early merge warnings at lane closures, etc.);

Table 3. ITS components.

ITS Component	Types
Sensors	<ul style="list-style-type: none"> <li>• Spot speed/volume/occupancy sensors</li> <li>• Cameras (manual visual monitoring and automated video detection)</li> <li>• Point-to-point travel time sensors (automated vehicle identification, or AVI; radio frequency identification, or RFID; automatic vehicle location, or AVL; Bluetooth; cellular telephone tracking)</li> <li>• Emissions sensors</li> <li>• RWIS/ESS</li> <li>• Vehicle-to-vehicle (V2V) and vehicle-to-infrastructure (V2I)</li> </ul>
Communications Systems	<ul style="list-style-type: none"> <li>• Cellular</li> <li>• Wireless (Wi-Fi), private or public</li> <li>• Satellite communications</li> <li>• Dedicated short range communications (DSRC)</li> </ul>
Software and Electronic Equipment	<ul style="list-style-type: none"> <li>• Portable CMS (PCMS)</li> <li>• Dynamic Signs</li> <li>• Specialized signs (e.g., variable speed limit operations)</li> <li>• Highway Advisory Radio (HAR)</li> <li>• Websites</li> <li>• Smart phone/tablet applications</li> <li>• Social Media</li> <li>• Text Alerts</li> </ul>

Source: Battelle

<sup>11</sup> For more information about the National ITS Architecture, see Appendix A, and [http://ops.fhwa.dot.gov/its\\_arch\\_imp](http://ops.fhwa.dot.gov/its_arch_imp)



- Customized work zone ITS solutions that are specially designed to meet a precise traffic management need, such as the deployment of temporary sensors or temporary ramp metering devices at selected problem locations to be integrated into and operated using an existing TMC. This type of system may require additional services, such as system design support and software development and integration;
- Services or data only (no equipment) that provides the agency with information to monitor, manage, and/or measure the performance of traffic within and around the work zone. The agency makes use of what others have already deployed and does not need to procure equipment to obtain the data.

The FHWA Work Zone Mobility and Safety Program provides numerous case studies and resources available to help transportation professionals familiarize themselves with the current state of the practice on ITS in work zones.<sup>12</sup> Topics include the benefits of using ITS in work zones, automated work zone information systems, traffic management systems including dynamic lane merge systems and speed management systems, PCMS, and work zone ITS deployment examples.



#### Example: Current strategies and how they can be used.

- The Michigan Department of Transportation deployed ITS during a total closure of I-496 in downtown Lansing. This \$2 million system used 17 cameras and six queue detectors to gather and process data on current conditions, and 12 CMS to display advance traveler information to the public to help alleviate traffic congestion resulting from the full closure of a major freeway.
- The New Mexico Department of Transportation deployed ITS during the reconstruction of the I-40 and I-25 “Big I” interchange in Albuquerque. The \$1.5 million system used eight cameras, eight modular CMS; four arrow dynamic signs; four all-light emitting diode (LED) portable CMS trailers; four portable traffic management systems, which integrate cameras and CMS on one fully portable unit; and four HAR units, all linked electronically to the temporary Big I TMC to better manage incidents during the project.

Work zone ITS applications are continuously evolving to better address issues. The Transportation Research Board (TRB),<sup>13</sup> American Association of State Highway and Transportation Officials (AASHTO),<sup>14</sup> and American Traffic Safety Services Association (ATSSA)<sup>15</sup> have committees and conference sessions that focus on work zone operations. These serve as forums for practitioners to share information on the latest applications and emerging technologies.

Additionally, emerging connected vehicle technologies that incorporate V2V and V2I communications will present major opportunities for communications and data gathering for work zone systems. Portable information devices such as smartphones and tablets provide increased opportunities for information dissemination by agencies, but must be used carefully because of the safety concerns associated with distracted driving.

Communications are a critical component of ITS. Table 4 summarizes the different communication systems that have been used and some key considerations for each communication option.

A factor to be considered is how various communication options are affected by physical features of the work zone, such as terrain, foliage, number and size of buildings in the area, and other wireless networks in use nearby. Wireless systems may not perform as well due to interruptions in the line of sight.

Two groups of professionals may be helpful to an ITS project manager when dealing with communications issues: state DOT maintenance personnel, and local radio contractors. Public agency maintenance personnel responsible for other communications systems used by the state can provide valuable assistance. Typically, these other communication systems are installed in the field and must meet high performance standards similar to what the ITS work zone system will require. This consideration is even more important in rural areas, where communication options become more limited due to lack of key infrastructure.

The FCC has identified unlicensed bands in the 2.4 GHz range that are suitable for supporting a variety of data and voice communications. The availability of unlicensed communications has stimulated many

<sup>12</sup>Available at: <http://www.ops.fhwa.dot.gov/wz/its>.

<sup>13</sup>Available at: <http://www.trb.org>.

<sup>14</sup>Available at: <http://www.transportation.org>. For information specific to work zone ITS, see: <http://ssom.transportation.org/Pages/ITSinWorkZones.aspx>

<sup>15</sup>Available at: <http://www.atssa.com>.



Table 4. Communication options, advantages, and disadvantages.

	Advantages	Disadvantages	Comments
Cellular (commercial wireless)	<ul style="list-style-type: none"> <li>• Good in areas lacking landline systems</li> <li>• Common system interfaces available</li> </ul>	<ul style="list-style-type: none"> <li>• Coverage may be limited, especially in rural areas away from major traffic corridors</li> <li>• Commercial system that may be “oversold” and subject to availability of signal</li> <li>• System is sensitive to terrain and time of year if deployed in areas with heavy foliage</li> </ul>	When using wireless Internet, the agency needs to ensure that system Internet protocol (IP) address has high enough priority, so that information flows through the network as quickly as possible.
Private Wi-Fi networks	<ul style="list-style-type: none"> <li>• Inexpensive for localized communications between devices</li> <li>• Wide area coverage is possible but more costly</li> <li>• Not dependent on commercial cellular service</li> </ul>	<ul style="list-style-type: none"> <li>• Lengthy license application may be required</li> <li>• Intermodulation studies may be required</li> <li>• Terrain may affect coverage</li> <li>• Additional infrastructure such as antenna towers may be needed for longer-range communications</li> <li>• Frequency availability may be limited</li> </ul>	
Satellite System	<ul style="list-style-type: none"> <li>• Good for areas lacking landline systems or cellular coverage that require internet access or long-range communications</li> <li>• Not dependent on location or terrain for strength of signal (urban or rural)</li> </ul>	<ul style="list-style-type: none"> <li>• Commercial system may be “oversold” and subject to availability of signal</li> <li>• Cost may be higher relative to other systems</li> <li>• Signal strength may fade during severe weather and heavy rain</li> </ul>	Compare the different options to see which system provides the best fit based on project needs.
High frequency radio	<ul style="list-style-type: none"> <li>• Wide area coverage</li> <li>• Good in areas lacking landline systems</li> <li>• Not dependent on commercial cellular service</li> <li>• Inexpensive</li> </ul>	<ul style="list-style-type: none"> <li>• Lengthy license application may be required</li> <li>• Intermodulation studies may be required</li> <li>• Terrain may affect coverage depending on frequency available</li> <li>• Additional infrastructure, such as antenna towers, may be needed</li> <li>• Frequency availability may be limited</li> <li>• Others may illegally use the same frequency causing the message to be “jumbled” or “walked on”</li> </ul>	Highway advisory radio systems use cellular due to issues with availability of Federal Communication Commission (FCC) license.

Source: Battelle

communications vendors to produce the necessary equipment. As such, the costs for implementing such connectivity have been reduced dramatically. The Unlicensed National Information Infrastructure (UNII) band does not require licensing, and many communications products operate on this band.

For ITS, determining the appropriate type of communication is key. Depending on the type of contracting arrangement (if any), it may be up to the contractor to select types of communications equipment that satisfy the requirements and specifications. Specifications can be written to allow for a desired equipment model or brand to be used, if the agency has a particular piece of equipment in mind (e.g., satellite communications for areas where cellular communications do not exist, such as mountainous areas).



**Tip: Systems need to have reliable communications.**

The communications network for an ITS application is vital to the operation of the system and must be reliable. Issues that may impact communications need to be addressed early in the system development and deployment process. What may seem like a trivial issue at the outset may evolve into a more difficult problem when deploying or operating the system. Such issues include whether adequate cellular capacity is available and whether there are obstructions to signal transmission due to geography or terrain.

### 2.3 What are the potential benefits of an ITS deployment?

As indicated previously, benefits of ITS in work zones are realized by the public, businesses, the contractor, and by the agency. Benefit impact areas associated with the use of ITS in work zones can include safety, mobility, improved work productivity and durability, and customer satisfaction. Table 5 provides a summary of benefits that have been experienced for various work zone ITS.

### 2.4 How much will an ITS deployment cost?

Developing general cost estimates for various alternatives can be extremely useful in developing a plan for a realistic system. A first step is to examine the cost of similar systems deployed elsewhere in the state or in neighboring States. It is also beneficial to develop early cost estimates for the deployment options. If there are no other systems available for comparison in one’s own state or nearby, the next step is to examine similar systems deployed in other locations in the U.S. and even worldwide. These cost comparisons are made

more difficult by factors that may differ between regions, such as labor rates and availability of certain types of communications.

The cost of ITS in work zones can vary widely and is influenced by the scope of the overall work zone, procurement method, the type of system, and system goals:

- **Scope of the overall work zone** – The relative cost of ITS seems to be largely dependent on the scope of the overall work zone, such that the portion of the cost due to the ITS may be smaller in larger work zones and vice versa.
- **Procurement Method** – The cost of the work zone ITS can be very different for a system that is leased versus one that is purchased, or even a data purchase.
- **Type of system** – A more labor-intensive, complex, and specialized system is likely to be more expensive than a more standard work zone ITS deployment.
- **System goals** – Although sometimes agencies will develop a general plan and then inquire about the costs associated with implementing the plan, an

Table 5. Examples of benefits for various work zone ITS.

Work Zone ITS	Issue(s) being Addressed	States with Studies of Example Deployments <sup>1</sup>	Example of Benefits
Real-time Traveler Information	<ul style="list-style-type: none"> <li>• Congestion</li> <li>• Delay</li> <li>• Safety</li> </ul>	CA, DC, NE, OR	16-19% reduced traffic volumes (diversion) on affected route (CA)
Queue Warning	<ul style="list-style-type: none"> <li>• Safety (crashes)</li> </ul>	IL	Significantly reduced speed variance; reduced vehicle conflicts; queuing crashes reduced 14% despite an increase in both lane closures and vehicle exposure.
Dynamic Lane Merge (early merge, late merge)	<ul style="list-style-type: none"> <li>• Delay</li> <li>• Aggressive driving behavior</li> <li>• Travel speed</li> <li>• Safety</li> <li>• Queue length</li> </ul>	FL, MI, MN	Reduced forced and dangerous merges by factors of 7 and 3, respectively (MI)
Incident Management	<ul style="list-style-type: none"> <li>• Incident clearance time</li> <li>• Delay</li> </ul>	NM	Reduced average time to respond and clear incident from 45 minutes to 25 minutes (NM)
Variable Speed Limits (VSL)	<ul style="list-style-type: none"> <li>• Speed management</li> <li>• Safety</li> </ul>	VA, UT	Greater speed compliance vs. static signs; reduced average speed and variation (UT)
Automated Enforcement	<ul style="list-style-type: none"> <li>• Speed management</li> </ul>	MD, IA, IL, OR	Significantly reduced speeds by 3-8 mph (IL)
Entering/Exiting Vehicle Notification	<ul style="list-style-type: none"> <li>• Safety</li> </ul>	MN, PA	Signs warn drivers of a slow-moving construction or emergency vehicle entering or exiting the roadway to reduce crash risk.

<sup>1</sup>Additional information on these case studies can be found at: <http://www.ops.fhwa.dot.gov/wz/its>.

Source: Battelle

agency will be better able to develop an estimate if it has clearly defined its system goals and objectives and the concept of operations.

These factors can cause the cost of work zone ITS to range from several thousand dollars to several million dollars. As a rough estimate, purchasing a few sensors to add to an existing TMC might cost about \$5,000 plus an additional \$5,000-\$10,000 for integrating them with the existing system. Purchasing a larger system that includes four sensors, a PCMS, and some operations support for communications and data software for a simple queue warning system might cost about \$125,000, while doubling this to a system with eight sensors and two PCMS might increase the costs to about \$200,000.

There are several ways an agency may achieve potential cost savings. As already discussed, any existing ITS infrastructure and resources can be used to help manage work zone conditions, reducing the need for some temporary resources. During a work zone project, some agencies choose to accelerate deployment and use of ITS components intended for a future permanent system. In both of these cases, the permanent ITS is not an additional cost for the work zone project, other than any additional capabilities that may be used for work zone management. Finally, the modularity of the work zone ITS can be assessed to separate “wants” from “needs” to accomplish system goals and objectives. Identifying essential ITS elements in the system up front can help to avoid excessive cuts that compromise the value of a system just to save money.

Several tools are available to help agencies develop an accurate estimate of ITS alternatives. The ITS Benefits and Unit Costs Database<sup>16</sup> contains unit cost estimates for over 200 ITS technologies. In addition, ITS Deployment Analysis System (IDAS) is a software tool that estimates the costs and benefits of ITS investments.<sup>17</sup> Finally, FHWA’s “Operations Benefit/Cost Analysis Desk Reference” might serve as useful guidance to agencies.<sup>18</sup>

Note that early project estimates are often insufficient to cover work zone ITS needs, and the funding amount is difficult to change by the time those who would identify a need for work zone ITS are involved in a proposed project. This re-emphasizes the need to engage stakeholders early, including staff that handle permanent ITS within the transportation agency, and to conduct work zone ITS deployment considerations with the context of TMP development so they are included in traffic management cost estimates.

## 2.5 What are potential institutional and jurisdictional challenges?

Institutional and jurisdictional challenges are often more difficult to overcome than the technical issues associated with technology deployment. Typical institutional or jurisdictional challenges for deploying an ITS application in a work zone include:

- Lack of adequate funding provided in the construction contract
- Lack of staff expertise in work zone ITS design, deployment, or operations
- Effects of delays or traffic diversion on other routes or neighboring jurisdictions
- Coordinating operations and incident response between agencies during incidents within the work zone
- Issues relating to command and control of existing ITS assets, when using existing ITS infrastructure for work zones
- Potential duplication of roles already performed by different departments
- Changing long standing operational procedures
- Increased or new maintenance requirements
- Convincing management to try something new
- Acknowledging and quantifying end user benefits for justification of work zone ITS
- Assuring acceptable system performance.

The best means of identifying and mitigating many of these challenges is to be as inclusive as possible during the development of system objectives and the overall system strategy. Discussions with all key stakeholders can help to identify potential issues at the earliest stage of the system development process. This is especially important when planning ITS to be used in work zones near jurisdictional boundaries. Agencies in the adjacent jurisdiction should be contacted at the earliest possible point in the project planning stage. Furthermore, these initial contacts should take advantage of any existing inter-agency relationships. By engaging stakeholders early to identify possible issues, time is more likely to be available to make any necessary adjustments in staffing, policies, or resources prior to the work zone ITS deployment. These discussions can lead the way to not only avoiding problems during the duration of the work zone, but can also lead to long-term coordination between jurisdictions on a wide variety of other issues.

<sup>16</sup>Available at: <http://www.benefitcost.its.dot.gov>.

<sup>17</sup>More information about IDAS can be found at: <http://idas.camsys.com>. IDAS is available for purchase from the McTrans Center for Microcomputers in Transportation at the University of Florida at: <http://mctrans.ce.ufl.edu>.

<sup>18</sup>Available at: <http://www.ops.fhwa.dot.gov/publications/fhwahop12028>.

For many agencies, a major barrier to the deployment of ITS in work zones is the reluctance to try something new. This could stem in part from a lack of staff expertise. Information is available on different types of systems and potential benefits to help educate decision-makers and practitioners to overcome this barrier. Peers at other agencies may be useful resources. The FHWA Peer-to-Peer Program for Work Zones can provide peer connections, and conducted a work zone ITS peer exchange in May 2013 that provided valuable information exchange amongst peers.<sup>19</sup> The deploying agency should seek multiple resources to gain a fuller understanding of any unfamiliar system. One barrier to ITS use can be that DOT staff with ITS expertise are in a different department from those doing road design and construction, and those two groups often do not interact regularly. Sharing expertise between those who know ITS and those who know work zones can increase the chances for an effective ITS procurement and deployment. In some cases, it may be desirable to hire staff that have more expertise and familiarity with work zone ITS for this and future deployments.

## 2.6 Addressing legal and policy issues

A number of legal issues must be considered in planning to use ITS in work zones. The most obvious question is whether the type of system being designed is permitted in the current laws and regulations. For example, if the agency desires to use automated enforcement as part of a VSL deployment, it is important to know whether automated enforcement legislation is in place in that jurisdiction. Other legal issues to be considered include the potential increased liability for placing ITS equipment in the work zone and archiving of certain data collected by ITS components. For example, some agencies have discovered legal implications related to collecting and storing video images of crashes. Additionally, the agency should consider possible liability issues about how warnings and messages are given (e.g., if the ITS fails to detect a queue and issue the appropriate warning, has liability been increased?). In considering these issues, the agency should also consider the overall benefits of having a system and any work zone risks (e.g., for crashes) it may help mitigate as well.



### Example: Automated Speed Enforcement in work zones.

Several states, including Illinois, Maryland, Washington, and Oregon, allow the use of automated speed enforcement in work zones. Each of these states has required enabling legislation before deployment of these systems. As an example, the legislation for Washington state\* includes:

- Restrictions on the locations where automated speed enforcement would be allowed
- Specified only images of the vehicle and vehicle license plate were allowed
- Requires the automated speed enforcement zone be clearly marked
- Specifies the method for notifying registered vehicle owner and vehicle owner responsibilities

\*See Engrossed Substitute House Bill 1175 of the 62nd Legislature, 2011 Regular Session for Washington: <http://apps.leg.wa.gov/documents/billdocs/2011-12/Pdf/Bills/House%20Passed%20Legislature/1175-S.PL.pdf>

## 2.7 How can project feasibility be established?

Based on the steps outlined above, key stakeholders should assess the overall feasibility of the original approach and the need to revisit overall objectives for the system. For example, objectives for the system may simply be outside the available budget, in which case objectives might be constrained. Another key consideration in assessing project feasibility is whether ITS is the best TMP strategy to deploy to address the identified needs, or if other non-ITS options may be better for the given situation.

Assessing project feasibility is especially important when planning work zone applications that involve more risk, such as larger deployments that involve more cost or deployments that may involve sensitivities. Examples of these types of deployments may include automated speed enforcement (in this case, due to higher political risk) or route diversion from highways to local roads. Such applications are more likely to draw additional scrutiny, encounter additional challenges, and may incur higher costs that should be considered when assessing project feasibility.

<sup>19</sup>For more information, including the materials from the work zone ITS peer exchange, see: <http://www.ops.fhwa.dot.gov/wz/p2p/index.htm>.

In addition to the project manager, key stakeholders that should participate in this step include senior agency managers, contracts personnel, and engineering staff. Senior managers are needed because they may have originally defined the operating strategy that may have to be revised, and because they can provide accurate information on the availability of funding and other key resources. Contracts personnel can identify various contracting options available, as well as discuss advantages and disadvantages of each of these options. Engineering staff may be needed if questions arise regarding the feasibility of the project schedule or technical approach. In some cases, it may be helpful to have engineering staff perform modeling to help establish the need for a system and to assess how likely impact mitigation is to occur in the event that a system is deployed. For example, modeling of the work zone may show long queues that become manageable if 10 percent of traffic diverts, which may be achievable with real-time traveler information provided by ITS.

Numerous sets of criteria have been developed and could be used to establish project feasibility. Some criteria, such as those developed by Michigan DOT, are specific to various ITS, e.g., dynamic lane merge system, real-time information system, and PCMS with radar capabilities. Similarly, criteria have been developed for advanced traveler information systems under the Smart Work Zone Deployment Initiative.<sup>20</sup> These criteria consider factors such as queue lengths, average daily traffic (ADT) and peak period traffic volumes, availability of alternate routes, and sight distances. North Carolina DOT developed criteria for use of an ITS-based SMARTZONE system in work zones based on whether the location is urban/suburban, rural, or mountainous.

FHWA drafted a general set of scoring criteria that agencies can tailor as desired for their use as one possible way to assess the feasibility for ITS (see Table 6). The intent for these criteria was to assist decision makers by providing a structured approach to considering the need for work zone ITS on specific projects. For each result, other mitigation treatments should be considered, as applicable, in addition to work zone ITS since ITS is only one possible solution for stakeholders to use to address a given issue in a work zone and may not be the best alternative.

Table 7 presents another possible way to consider when to use work zone ITS. It can be used as a general application guide to assess the characteristics and conditions existing or anticipated in a given work zone that would help justify implementation of one or more of the systems.

Table 7 attempts to illustrate how some of these applications may be designed to address certain conditions, but could also address other conditions through some modifications to the typical deployments or the introduction of a human operator who could make real-time adjustments in how the systems respond. Similarly, some work zone issues could be addressed through more than one type of system. As an example, a real-time traveler information system could address work zone conditions where unexpected or variable periods of travel delays and congestion will arise, and there is potential to encourage route, departure, and mode choice diversions through the provision of real-time information. However, these same conditions could also be addressed through implementation of a work zone incident management system. Whereas a typical work zone traveler information system will operate autonomously based on a limited set of rules, the incident management system would rely on an operator present to monitor and detect incidents to also modify the information dissemination devices if needed to encourage diversion.

An ITS application may not be appropriate for every work zone nor be the best solution for a given issue. Other alternatives should also be examined. The expected project location, project impacts, and project duration are likely to influence whether or not a particular ITS solution merits consideration. Other factors like traffic volumes and project layout will also influence whether or not work zone ITS are applicable for a particular project. For example, if the concern is potential congestion in a work zone, one solution can be to use ITS to monitor traffic conditions and provide traveler information. Some other possible mitigation strategy alternatives to using ITS are a public information campaign to reduce travel demand in the area; maintaining more lanes by using the shoulder to carry traffic; conducting work at night when traffic volumes are generally lower; including lane closure restrictions in the contract to affect less traffic and minimize impacts; a motorist assist patrol to quickly identify and address vehicle breakdowns and other incidents; or using a movable barrier to provide an additional lane for peak period traffic flow.

<sup>20</sup>See "Criteria for Portable ATIS in Work Zones" by Alan J. Horowitz at: [http://ssom.transportation.org/Documents/2005\\_horowitz\\_atis\\_criteria.pdf](http://ssom.transportation.org/Documents/2005_horowitz_atis_criteria.pdf)



Table 6. Example set of scoring criteria to establish feasibility of work zone ITS. (Source: FHWA)<sup>21</sup>

Criteria	Score
Factor 1 – Duration of work zone: Long-term stationary work will have a duration of: <ul style="list-style-type: none"> <li>• &gt;1 construction season (10 points)</li> <li>• 4-10 months (6 points)</li> <li>• &lt;4 months; procurement and installation timeline is available prior to work starting (3 points)</li> </ul>	
Factor 2 – Impact to traffic, businesses, other destinations, or other users (e.g., extremely long delays, high risk of speed variability, access issues) for the duration of work is expected to be: <ul style="list-style-type: none"> <li>• Significant (10 points)</li> <li>• Moderate (6 points)</li> <li>• Minimal (3 points)</li> </ul>	
Factor 3 – Queuing and Delay: Queue lengths are estimated to be: <ul style="list-style-type: none"> <li>• ≥2 miles for periods ≥2 hours per day (8 to 10 points)</li> <li>• 1-2 miles for periods of 1-2 hours per day (6 to 8 points)</li> <li>• ≤1 mile, or queue length estimates are not available but pre-construction, recurring congestion exists for periods &lt;1 hour per day (4 points)</li> </ul>	
Factor 4 – Temporal Aspects of Traffic Impacts: Expected traffic impacts are: <ul style="list-style-type: none"> <li>• Unreasonable for a time period that covers more than just peak hours (10 points)</li> <li>• Unreasonable during most of both morning and afternoon peak hours in either direction (6 points)</li> <li>• Unreasonable during most of a peak hour in either direction (3 points)</li> <li>• Unpredictable; highly variable traffic volumes (1 point)</li> </ul>	
Factor 5 – Specific Issues Expected (0 to 3 points each based on judgment) <ul style="list-style-type: none"> <li>• Traffic Speed Variability</li> <li>• Back of Queue and Other Sight Distance Issues</li> <li>• High Speeds/Chronic Speeding</li> <li>• Work Zone Congestion</li> <li>• Availability of Alternate Routes</li> <li>• Merging Conflicts and Hazards At Work Zone Tapers</li> <li>• Work Zone Hazards/Complex Traffic Control Layout</li> <li>• Frequently Changing Operating Conditions for Traffic</li> <li>• Variable Work Activities (That May Benefit From Using Variable Speed Limits)</li> <li>• Oversize Vehicles (Percent Heavy Vehicles &gt;10%)</li> <li>• Construction Vehicle Entry/Exit Speed Differential Relative to Traffic</li> <li>• Data Collection for Work Zone Performance Measures</li> <li>• Unusual or Unpredictable Weather Patterns Such as Snow, Ice, and Fog</li> </ul>	
<b>Total Score</b>	
If the total score is: <ul style="list-style-type: none"> <li>• ≥30 – ITS is likely to provide significant benefits relative to costs for procurement</li> <li>• ≥10 and &lt;30 – ITS may provide some benefits and should be considered as a treatment to mitigate impacts</li> <li>• &lt;10 – ITS may not provide enough benefit as a treatment to justify the associated costs</li> </ul>	

<sup>21</sup>This is not the only way or criteria that could be used. Agencies can tailor this to their needs or use their own criteria.

Table 7. Possible work zone ITS applications to consider for various critical project characteristics.

Critical Project Characteristics	Work Zone ITS Applications								
	Queue warning	Real-time traveler information	Incident management	Dynamic lane merge	Variable speed limit	Automated enforcement*	Construction vehicle entrance and exit warning	Temporary ramp metering	Performance measurement
Frequent planned lane closures are expected, which will create queues that cause high speed differentials between queued and approaching traffic	●	●		○	●				
Emergency shoulders will be closed through the work zone and frequent stalls and fender-benders are expected to occur that will cause queues because they cannot be quickly moved to the shoulder	●	●	●						
Travel times and delays through the work zone will be highly variable and real-time information can improve pre-trip and real-time route choice, departure time, and possibly mode choice decisions		●	○						
Roadway access for emergency response vehicles will be significantly constrained by the project, increasing response and clearance times			●						
Frequent incidents are expected to occur within the project	○	●	●						
Having an operator able to view an incident within the project and assist responders in bringing appropriate equipment to the site will significantly reduce incident duration			●						
A long-term lane closure will create a v/c condition that is very close to 1.0, and improved flow rates through the lane closure could reduce the likelihood that a queue would form, or reduce its duration significantly when a queue did form				●				●	
The potential exists for queue spillback from the work zone into upstream interchanges or intersections (and resulting increase in cross-street congestion and rear-end crashes) due to an unequal utilization of all lanes, such that the encouragement of the use of all lanes for queue storage would reduce that probability of spillback conditions.		○	○	●					
Work activities will frequently occur for which lower speed limits would be beneficial to have on a temporary basis (i.e., during temporary lane closures on freeway mainlanes, for temporary full road closures, during periods construction vehicle/equipment access into and out of the work space from the travel lanes, etc.)			○		●		○		
Traffic speeds through the project vary widely due to oversaturated conditions during the peak period, and the timing and extent of congested travel will vary significantly day to day		○			●				
A reduced speed (and thus speed limit) is believed to be necessary because of work zone hazards that are not readily apparent to motorists and so will not likely result in lower speeds driven						●			
The project plans limit ability of enforcement to operate (no shoulders, barrier on both sides, long stretches between interchanges)						●			
Access to and from the work space occurs directly from the travel lanes							●		
A high number of construction vehicle deliveries into the work space will be required during the project							●		
The location and design of the access points could create confusion for motorists (i.e., access to the work space looks like an exit ramp and is near an existing actual exit ramp)		○					●		
Little or no acceleration lane is available for construction vehicles entering the travel lanes from the work space		○					●		
Capacity reductions in the work zone now create an oversaturated condition due to merging ramp vehicles								●	
Temporary ramp geometrics have constrained acceleration lane lengths								●	
Work activities have temporarily disabled one or more permanent ramp meters within the limits of an operational ramp metering system								●	
Work zone ITS is already being deployed for other purposes									●
Project documents include traffic mobility performance requirements (i.e., maximum allowable delays) that must be monitored to ensure and quantify compliance and subsequent incentives or penalties to be issued (performance specifications of mobility impacts [delay or queues])									●
The agency chooses the project for assessment purposes as part of its federally-mandated bi-annual process review									●

\* Assumes that the state transportation code allows use of automated speed enforcement in work zones

Source: Battelle

● Characteristic could be addressed with this work zone ITS application

○ Characteristic could be addressed with this work zone ITS application if some modification(s) were made or real-time actions taken by an operator.





**Key Point: Whether to use ITS to address a work zone need has to be assessed because work zone ITS may not be the only or best way to address a particular issue.**

For example, project staff at case study sites in Effingham and Mount Vernon, IL considered whether to use ITS the need for queue warning. Because on the need for automatic queue warning and delay information dissemination, staff at both projects considered alternatives and decided early on that some type of work zone ITS would be deployed. There had been previous efforts by Illinois DOT to warn drivers approaching a work zone with queues through the use of either enforcement personnel positioned upstream of the work, or through the use of Illinois DOT staff with truck-mounted CMS. The difficulties of predicting when queues would occur, having sufficient staff available to schedule during those times, and keeping the warning device (enforcement vehicle or the truck-mounted CMS) in the proper location relative to the end of the queue reduced the practicality of these approaches. Illinois DOT staff were also concerned with the potential liability associated with sometimes, but not always, being able to have an enforcement vehicle or truck-mounted CMS present when queues were expected.

Stakeholders should consider the differences in costs, as well as benefits that each alternative would provide. For example, even though an ITS deployment would likely cost more than a public information campaign, the ITS deployment provides real-time information and can monitor the work zone status. While a public information campaign is good for steady state conditions or specific events, ITS is good for a dynamic work zone in which roadway configuration may change on a frequent basis.

In weighing the benefits and cost of different strategies for addressing work zone issues, it is helpful to keep in mind that work zone ITS can give multiple benefits that sometimes exceed the primary objectives. For example, a work zone ITS deployment may enable traffic management in real-time, better deal with changing traffic conditions, and provide data for both performance monitoring and assessment of benefits, even though initial objectives may have been focused on providing information to travelers. More benefits may be provided by work zone ITS than cheaper alternative solutions (e.g., public information campaigns that only addresses the initial objective).

Several analytical tools have been developed for use in evaluating work zone traffic control strategies. The FHWA has developed a traffic impact analysis spreadsheet, known as QuickZone.<sup>22</sup> QuickZone can estimate the delay impacts of various work scheduling or configuration alternatives, such as doing work at night instead of during the day or of diverting the traffic to various detour routes during different phases of the construction. The FHWA Traffic Analysis Toolbox includes guides for work zone modeling and simulation.<sup>23</sup> These documents provide guidance on using analytical tools in work zone planning and management, including work zone analysis, selecting a modeling program, and approach.

## 2.8 How can buy-in be obtained from stakeholders and other agencies?

Ideally, buy-in from core stakeholders should be achieved during Step 1. However, some agencies may choose to wait until the vision for the system is more mature before bringing in the entire spectrum of stakeholders listed previously. The size and magnitude of the work zone, as well as the expected complexity and scale of deployed ITS technology in the work zone, will impact the timing. For example, if a simple off-the-shelf system is being deployed, a general notification to key stakeholders should be sufficient. However, other cases will require more active participation, closer coordination, and stakeholder buy-in earlier, such as a case where ramp metering or a transit or truck bypass is being considered for a work zone.

The scope of the work zone project will affect the level of stakeholder buy-in required, as well as how difficult it will be to attain it. Buy-in for temporary or short-term work zone projects that do not affect long-term operations will generally be easier to obtain than similar buy-in for long-term projects requiring permanent changes in procedures or staffing responsibilities, although the costs may be harder to justify for shorter-term projects. As complexity or duration of the project increases, so too does the requirement for greater contact with affected agencies.

Peer-to-peer contact, i.e., developing inter-agency relationships among staff at the same level, is typically the most effective form of interaction. These relationships should be developed at the line supervisor and even the operator level, depending on the scope of the project. Cross-training, i.e., having staff from a different agency work alongside host agency staff for

<sup>22</sup>More information about QuickZone is available at [http://ops.fhwa.dot.gov/wz/traffic\\_analysis/quickzone/](http://ops.fhwa.dot.gov/wz/traffic_analysis/quickzone/). QuickZone is available for purchase from the McTrans Center for Microcomputers in Transportation at the University of Florida at: <http://mctrans.ce.ufl.edu>.

<sup>23</sup>More information on the FHWA Traffic Analysis Tools, specifically Work Zone Modeling and Simulation Guidance in Volumes VIII, IX, and XII can be found at: <http://ops.fhwa.dot.gov/trafficanalysistools>.

a fixed period of time, has been effective in fostering better working relations and understanding of key needs. Another useful tool in obtaining buy-in from varying stakeholders is to communicate the estimated benefits

for each individual agency being recruited. Answering the question “What’s in it for me?” is an effective way to elicit support from other agencies.

**Key Takeaways**

- The main product of Step 2 is a concept of operations report. This report builds on information gathered and established in Step 1, and documents a vision for the system, such as the one illustrated in Figure 11. It should incorporate the goals and objectives of the system and the system strategy, and serve as a guide for system development. The report should also provide a summary of the processes in Steps 1 and 2 and document stakeholder input. The report should be scalable to the extent and complexity of the system.
- Engage ITS staff as a source of expertise.
- Achieving a broad level of consensus in this step is a prerequisite to moving to Step 3. Presenting the results of Step 2 to a stakeholder group is essential. Agencies sometimes skip this consensus-building step and move on to requirements and design. When that happens however, the agency will likely get mired in unanticipated questions and issues from stakeholders later that would have been easier to address sooner.

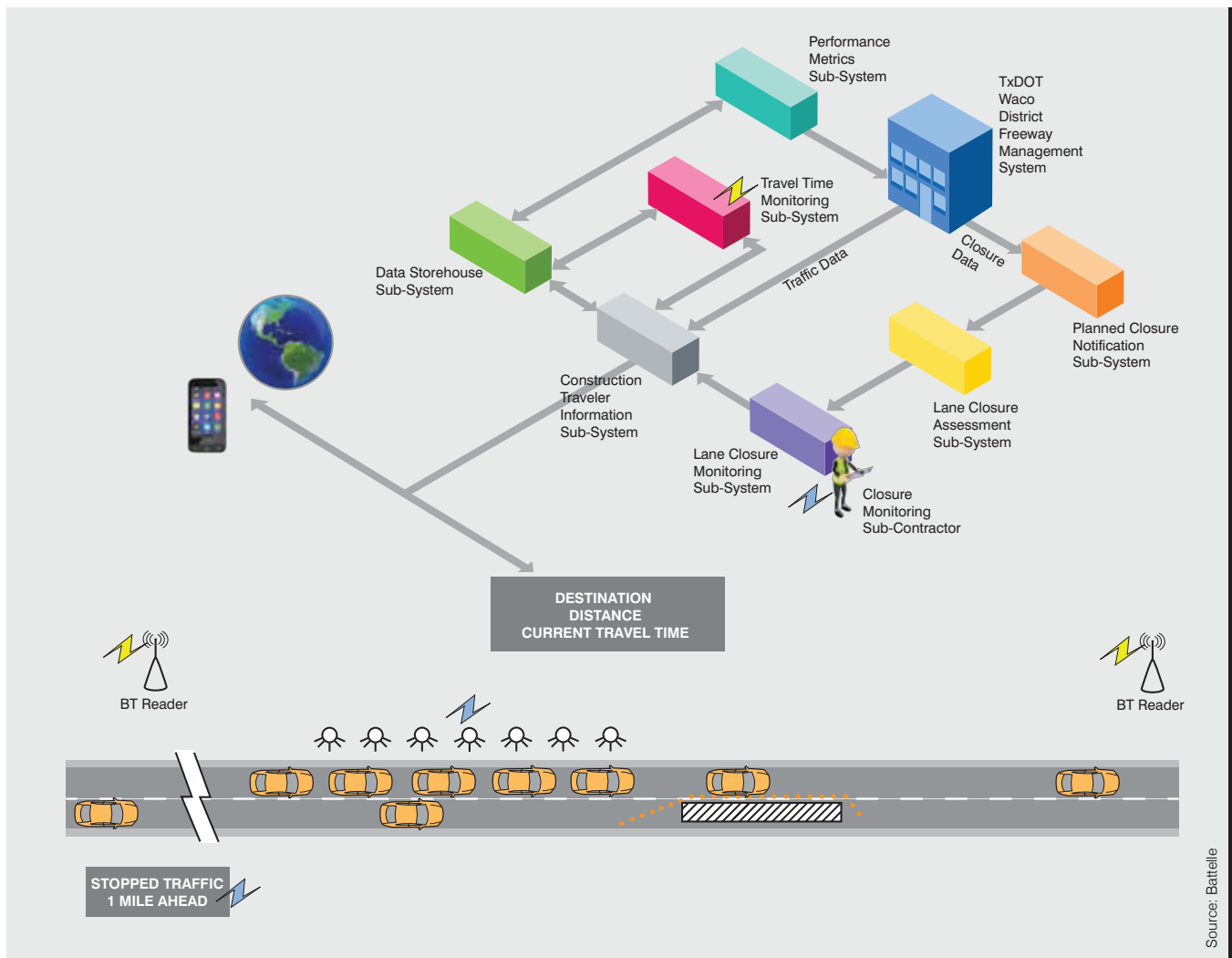

Figure 11. The product of this step should include concept of operations scenarios, such as this graphic for a work zone traffic management system.



The main objectives of Step 3 are to develop system requirements and specifications, develop performance measures for the system objectives, and prepare plans for deployment and subsequent operations and maintenance. The product of this step will be the overall Work Zone ITS System Plan. Sub-steps to developing the plan are depicted in Figure 12. These steps should be done within the context of TMP development, implementation, and evaluation for coordination with other TMP strategies.

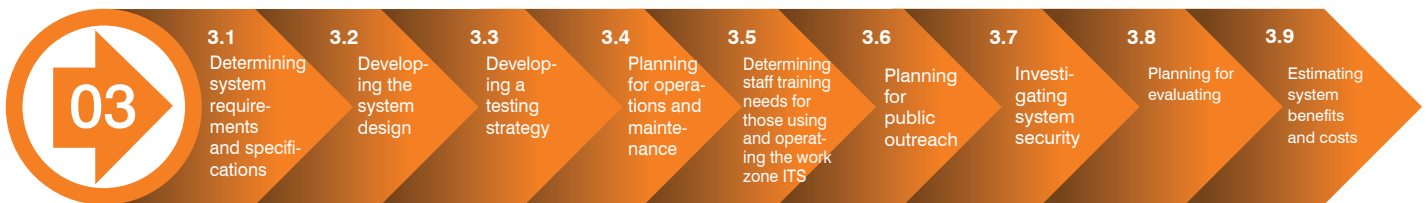

Figure 12. Sub-steps to be explored in Step 3.

Source: Battelle

### 3.1 Determining system requirements and specifications

The objectives of the ITS work zone application and the manner in which it would operate to achieve these objectives are documented in the concept of operations developed in Step 2. The next step is to develop system requirements. These requirements define what the system will do. System requirements and specifications will be most effective if they also define performance targets and requirements. Typically, a trade-off exists between the amount (and cost) of system features and components (i.e., spacing and coverage of sensors, number and types of information dissemination devices, and services to be provided, etc.). Defining performance targets and requirements provides a basis for deciding what features and components are critical to achieve system objectives. All requirements should link with specific user needs and/or operational policies and

constraints established in the concept of operations documents to preserve traceability. No requirement should exist that does not link to a user need, operational policy, or operational constraint, and vice versa.

By conducting a thorough and well-focused requirements generation process, agency staff will better manage stakeholder expectations, ensure that the key needs identified earlier are addressed, and gain consistent understanding of and buy-in for the system, and will be able to develop a more realistic estimate of the project deployment schedule and cost. The level of effort required for this activity depends on whether the agency has used a system of similar capabilities in the past and has past requirements and specifications (its own or from a peer agency) from which to work, and how many unique or unusual objectives exist. The National ITS Architecture<sup>24</sup> can help define requirements and

<sup>24</sup>For more information, see: <http://www.iteris.com/itsarch/>

specifications, and should be consulted and followed when designing such systems. For more complex projects, the requirements documentation process should be done in two levels to include first high-level requirements, then detailed requirements.

Some examples of system requirements that have been developed by state DOTs for several types of work zone ITS are available from AASHTO.<sup>25</sup> The examples are from several State DOTs, including Michigan, Minnesota, Missouri, and North Carolina, and cover real-time traveler information systems, speed management, and dynamic lane merge systems. An example of requirements for a work zone ITS are presented in Figure 13 below.

Requirements will necessarily vary for various types of systems, deployments, and agencies. As an example, a Minnesota project team developed this set of physical, functional, system, and maintenance requirements for the deployment of a traffic monitoring system in a work zone.

#### Physical Requirements

1. The system shall be self-contained in a traffic barrel.
2. The traffic barrel shall be indistinguishable from other traffic barrels to passing drivers.
3. The device shall meet crash safety standards for use on the National Highway System.

#### Functional Requirements

1. The system shall detect speed of vehicles travelling towards the sensor.
2. The system shall detect the volume of vehicles travelling towards the sensor.
3. The system shall have a cellular modem for communication to the central office when cellular access is available.
4. The system shall have a satellite modem for communication to the central office when cellular access is not available.
5. The system shall report speeds within three miles per hour of actual speeds.
6. The system shall be configurable to report data every minute.
7. The system shall be configurable to operate in a continuous data collection mode.

#### System Requirements

1. Data requirements
  - a. The system shall report data in real time.
  - b. Real time data shall be available from a designated website.
  - c. The system shall report data to the central office.
  - d. The system shall report adjustable binned historical data.
    - i. System shall report 85<sup>th</sup> percentile speed data.
    - ii. System shall report 50<sup>th</sup> percentile speed data.
    - iii. System shall provide a binned speed curve.
  - e. Binned historical data shall be downloadable from a designated website.
    - i. Historical data shall be downloadable in Microsoft Excel format.
  - f. The system shall be capable of providing per vehicle speed records.
2. Website requirements
  - a. Data recorded by the device shall be available on a designated website.
  - b. Historical data on the website shall be password protected.
  - c. The website shall provide a mapping function that pictorially illustrates the location of the devices.
  - d. The website shall provide a mapping function that pictorially displays speed data in a color-coded format.
  - e. The website shall provide both graphed and tabular historical data.
  - f. The website shall produce an XML feed that can be parsed by the DOT's traffic management software.

#### Maintenance Requirements

1. System setup shall only require one person.
2. System shall be powered with a sealed 12-volt battery.
3. System shall function for a minimum of 14 days on a single battery charge.
4. System battery shall be replaceable in the field without losing data.
5. System shall recharge within a 12-hour period when connected to 120 VAC power.

These requirements can be found at: [http://www.dot.state.mn.us/guidestar/2006\\_2010/icone/iconefinalrequirements.pdf](http://www.dot.state.mn.us/guidestar/2006_2010/icone/iconefinalrequirements.pdf).

Figure 13. Requirements for a work zone ITS deployment in Minnesota.

Source: Minnesota DOT

<sup>25</sup>The AASHTO work zone ITS website can be found at: <http://ssom.transportation.org/Pages/ITSinWorkZones.aspx>.



As part of the system requirements and specifications process, agencies should consider the potential need for, or opportunities of, establishing interoperability and connectivity with other ITS components and transportation management system components in the region. Doing so can result in significant economies of scale and expand the potential range of influence of a work zone ITS. For example, a work zone traveler information system could be designed to feed information to an agency's existing traveler information website or 511 system, rather than establishing a separate website or not making the information available online to the public and others. A work zone incident management system may be best accomplished by installing temporary devices in and around the work zone to monitor and view traffic conditions, and sending the data and images back to the regional TMC already in place, as depicted in Figure 14, rather than developing a separate temporary TMC for the project or relying solely on DOT project staff to monitor the images. The FHWA publication *Designing for Transportation Management and Operations: A Primer* would be a useful resource for these considerations.<sup>26</sup>

Work zones are often dynamic and frequently changing throughout a project. Consequently, the system requirements and specification definition process should also address if and how the system must respond to changes in the work zone environment over time. Whether it be a change in device location to accommodate major traffic switches, adjustments in the thresholds being used to activate certain control and management functions, or provisions in a contract

that determine when the system is no longer needed, it is important to think through and capture these requirements at this point in the design process. With respect to system duration considerations, work zones can be finished ahead of schedule or be delayed. Consequently, it is often a good idea to include contingency plans within the system design process. Adding a contingency plan could increase costs somewhat, but may be preferable to having to retrofit the system after the fact.

### 3.2 Developing the system design

Development of the system design will take into consideration much of the documentation assembled in previous steps. The concept of operations from Step 2 describes how the system will work, and system requirements and specifications provide more specific details for what the system needs to do. In this step, the hardware and software interfaces, site plans for the system components, and the integration of the COTS elements are designed. It is important that the design team or contractor has access to all of this documentation when developing the system design, especially if innovative contracting methods are used.

The project team will establish the number and type of technological components during system design, if not already identified through the development of the requirements and specifications in substep 3.1. Alternatively, an agency may choose to allow a contractor to propose all or some aspects of the work zone ITS system design, given the requirements and specifications that the agency has developed. The system design provides additional detail regarding



Source: FHWA

Figure 14. The Las Vegas Freeway and Arterial System for Transportation (FAST) provides regional support for work zone activities.

<sup>26</sup>This document can be found at: <http://www.ops.fhwa.dot.gov/publications/fhwahop13013/index.htm>

the placement of components within the project area. Strategic placement of components such as sensors and PCMS is important for the work zone ITS deployment to be effective. For example, PCMS used for a queue warning system need to be placed upstream of the maximum expected queue length.

This is also an appropriate time to consider driver capabilities to verify that the system being planned for and/or designed will be satisfactory from a human factors perspective. Motorists can only process a limited amount of information while driving. It is important that any messages planned for display on CMS follow current guidance to ensure that the information is clear, concise, and credible. Characteristics of the devices and their deployment locations should also be considered. For example, the Manual on Uniform Traffic Control Devices<sup>27</sup> provides specifications for CMS, stipulating that the size of the text on a message display must be sufficiently large and visible (a minimum of 18 inch characters for freeway conditions) so that drivers do not have to slow down to give themselves more time to read. Message boards should be positioned away from obstructions that might limit viewing times, such as piers, abutments, parked construction equipment, etc. In areas with significant truck traffic, the agency should consider whether some message boards need to be on the left as well as the right side of a multi-lane road for visibility. The location should also be far enough upstream of key decision points to allow drivers time to process the information and take appropriate action.

The California DOT "Systems Engineering Guidebook For ITS" may serve as a useful reference during this step.<sup>28</sup>

### 3.3 Developing a testing strategy

Development of a coherent testing strategy to validate the functionality and accuracy of the ITS is a key component of successful deployment of the system in the demanding environment represented by a work zone. (Note: testing involves validation of the ITS functionality and accuracy before activation, while evaluation assesses the ITS system performance after activation.) The test plan can be prepared by an outside contractor, but should be closely scrutinized by the agency. The test plan does not need to be extensive in all cases; simple validation may be sufficient for a COTS system. Inadequate testing could fail to detect problems in system component operation until after the system is activated for the public.

The test plan should be scheduled to provide sufficient time for resolving any problems that may arise, as well as retesting, in case any part of the system fails the initial testing. Tests should be established for each detailed level requirement defined in Step 2. A table listing all detailed level requirements in one column and corresponding tests in the adjacent column is a useful tool for ensuring that the test plan is adequate. There should be one test for each requirement and a requirement for each test. If either a requirement or a test is missing its corresponding element, the table is not complete.

Acceptance testing typically consists of the following tests:

- **Functional testing** – requirement-by-requirement testing of the system's ability to meet specifications as envisioned.
- **Performance testing** – evaluates how well the system performs under various conditions
- **Throughput testing** – measures how quickly the system processes a discrete event of data transfer or how quickly the system responds to operator input
- **Storage testing** – measures the ability of the system to store data or handle the operation of multiple programs simultaneously
- **Stress testing** – evaluates system operation under the peak load it is expected to encounter
- **Failure mode testing** – evaluates the system's ability to diagnose, report, and respond to failures (e.g., field devices, central system computer, power)
- **Operability testing** – tests the system's ability to operate for long periods without failing (e.g., central software crash).

Test plans for the system should include the following elements:

- Test schedule developed as part of the overall project schedule, including sufficient time for resolving any problems that may arise, as well as retesting in case any part of the system fails the initial test
- Consistent test data used to populate files and databases prior to collection of actual data
- Data sheets used to record test data
- Expected test results including detailed level specifications that define expected system operating parameters (e.g., system reporting every 2 minutes), or other expected results if not called for in the specifications
- Requirements table listing requirements and corresponding tests

<sup>27</sup>Available at: <http://mutcd.fhwa.dot.gov>.

<sup>28</sup>Available at: [http://www.dot.ca.gov/newtech/docs/se\\_guidebook\\_ver1-12\\_14\\_05.pdf](http://www.dot.ca.gov/newtech/docs/se_guidebook_ver1-12_14_05.pdf)

- Test reports that tell the project team how well the system performed.

### 3.4 Planning for operations and maintenance

During the planning step, the agency needs to consider what will be needed for operating and maintaining the work zone ITS. For example, incorporation of work zone ITS components into a permanent ITS deployment may place additional demands on TMC staff. This needs to be recognized during the planning process. Ideally, these types of needs should be addressed as part of TMP development and implementation. Automated systems may require fewer agency operational considerations since operations and maintenance may be handled by the vendor.

The level of effort required for system maintenance planning depends largely on how the ITS portion of the work zone is procured. For example, some DOTs have procured work zone ITS as part of a larger construction contract, and maintenance was the responsibility of the contractor. Operations and maintenance are frequently overlooked in ITS application development.

In general, work zone ITS deployments tend to be concerned primarily with corrective maintenance issues, due to the short life span of these deployments. Short-term maintenance issues include tasks such as replacement of power source for the equipment (e.g., recharging or replacing batteries); minor adjustments of the location of system signs and detectors to reflect queue lengths that are different from what was anticipated; movement of equipment due to work zone configuration changes; and troubleshooting and repairing malfunctions. Longer-term issues, such as system enhancements, are less of a consideration.

Implementing agencies should carefully plan for maintenance needs when determining the response requirements for system uptime and penalties for system downtime. For example, the agency should specify if someone needs to be on-site 24/7, what response times are expected (e.g., within 4 hours, 24 hours), and what penalties will be assessed if a system is down and at what point (e.g., after 2 hours) the penalties will begin.

It is also important that provisions be made to maintain functionality of existing ITS. Many projects result in power (and thus system functionality) being lost, for example, unless special arrangements for maintaining capabilities are made in advance.

Due to the limited duration typical of work zones, operations and maintenance responsibilities can be

included with the procurement of the system. For example, an agency can pay a contractor a “per day” fee for the ITS application that includes operation of the ITS. The “per day” fee technique can result in significant staff time cost savings for the agency, as agencies are not required to dedicate staff to these projects or maintain inventories of spare parts. The agency should not be overly prescriptive regarding operational aspects of the ITS, such as requiring that the system process data on-site; vendors may be able to more cheaply process data off-site, and send it back to the field, as needed.



#### Example: Operations and Maintenance costs – I-70/I-57 Project in Effingham, Illinois.

Operations and maintenance costs can vary significantly for various reasons. A traffic management system was procured as part of the overall bid by the contractor for a work zone project on the I-70/I-57 interchange in Illinois. This was budgeted at \$1,800/month over 25 months (\$45,000 total) for 70 devices. Illinois DOT intended for the system to remain operational and used during 3 other contracts that were scheduled to occur within the section over the next several years. The next contract that was let also included this component, but was bid at much a different value: budgeted at \$29,767/month over 25 months (\$744,187 total) with only a few devices added from the previous contract. Agency and contractor understanding of desired operational conditions is important for requesting and submission of bid requests because the bid costs can vary greatly.

### 3.5 Determining staff training needs for those using and operating the work zone ITS

The amount of training needed will be determined by the approach that will be taken to procure, operate, and maintain the system. If the system will be leased, operated, and maintained by the vendor or a contractor, training of agency staff will focus primarily on operational aspects of the system. This can be very important as the agency, contractor, and vendor work to fine-tune the system. For example, for a recent work zone ITS deployment in Illinois, the agency, contractor, and vendor worked together to identify ways to improve the queue-end warning system, calibrating it to generate messages from queue length data, and make adjustments as necessary throughout the course of the project. However, if the agency will be responsible for operating and maintaining the ITS, agency staff will need to receive in-depth training on all aspects of the system. Agency staff will need to learn about each component of the system, and how the components work together, as well



as system set-up, maintenance requirements, testing techniques, and troubleshooting. The agency will need to determine the most appropriate people to receive the training, which would most likely be provided by the system supplier. Redundancy in staff training should be included to account for staff turnover and absences.

The National Highway Institute (NHI) offers courses addressing a wide variety of aspects of ITS.<sup>29</sup> The curriculum covers several topics of interest to project managers of work zone ITS, including systems engineering, project management, telecommunications, software acquisition, and ITS procurement.

The Consortium for ITS Training and Education (CITE),<sup>30</sup> composed of numerous university and industry partners, offers a wide variety of ITS online courses on topics that include incident and emergency management, transportation management, systems engineering, and rural ITS.

Other resources include ITS courses available through the Local Technical Assistance Program (LTAP).<sup>31</sup> Also, some agencies that operate and maintain permanent ITS have developed their own curriculum.

### 3.6 Planning for public outreach

An important step in the planning process is to determine the amount and type of public outreach that the agency wants to pursue to alert local residents and businesses to the system and its capabilities, including web-based information. For example, how useful would it be to display real-time traffic information on a website if nobody knew that the website existed or how to access it? Carefully prepared press releases and involvement in community meetings are some of the strategies employed with success by state agencies.<sup>32</sup> A number of agencies have learned that proactively working with the media has been a highly successful means of reaching out to the public. The media provides the agency with a free means of disseminating information to the public. It is important to plan for public interaction throughout the course of the project and should be done within the context of TMP development, implementation, and evaluation for the project, in order to keep the public informed and receive their feedback. An example of a press release is exhibited in Figure 15.

The FHWA offers a guide about “Work Zone Public Information and Outreach Strategies” that is designed to help agencies plan and implement effective public information and outreach campaigns to mitigate the negative effects of work zones.<sup>33</sup>



**Tip: It is important to use a proactive approach in building public awareness of the project and the information that the ITS application will provide.**

Successful techniques include holding press conferences, issuing news releases, and keeping local media (especially those the public turns to for traffic information) up to date.

<sup>29</sup>More information about the ITS curriculum is available on the ITS Professional Capacity Building (PCB) Program website at: <http://www.pcb.its.dot.gov>.

<sup>30</sup>More information at: <http://www.citeconsortium.org>.

<sup>31</sup>The LTAP resource database can be searched at: <http://www.ltap.org/resources/searchdbs.php>.

<sup>32</sup>Note that the Manual of Uniform Traffic Control Devices (MUTCD) prohibits the display of website addresses on CMS and PCMS.

<sup>33</sup>This guide is available online at: [http://www.ops.fhwa.dot.gov/wz/info\\_and\\_outreach/public\\_outreach\\_guide.pdf](http://www.ops.fhwa.dot.gov/wz/info_and_outreach/public_outreach_guide.pdf).

# NEWS RELEASE

STATE OF NEW HAMPSHIRE, DEPARTMENT OF TRANSPORTATION  
*Charles P. O'Leary, Commissioner*

For Immediate Release  
October 8, 2007

Contact: David Rodrigue  
I-93/ITS Project Manager  
(603) 271-6862  
Public Information Office  
(603) 271-6495

## **NHDOT DEPLOYS "SMART WORK ZONE" ON I-93 PROJECT IN SALEM**

***PURPOSE IS TO INFORM MOTORISTS OF WHAT TO EXPECT AHEAD***

The New Hampshire Department of Transportation (NHDOT) has deployed a Smart Work Zone System as part of the Interstate 93 Exit 1 rebuilding project. The primary goal of this system is to provide a safe and efficient travel corridor through the work zone by alerting motorists about what is happening along the road ahead.

The Exit 1 Smart Work Zone consists of changeable message signs that provide information to motorists as they travel through the work zone, traffic sensors that measure vehicle volumes and speed, and a mounted camera that provides images of traffic through the construction corridor.

Motorists will be able check travel conditions in the work zone via the internet and will receive vital incident or road construction information through changeable message signs strategically located within three miles north and south of the project area. Motorists will be able to use this information to prepare for stopped or slowed traffic ahead, or they may choose an alternative route. The idea is to let the motorist decide what action to take. Also benefiting from the Smart Work Zone will be emergency personnel responding to incidents on I-93 in the vicinity of Exit 1 in Salem.

The Smart Work Zone has a website link that may be accessed through the I-93 project website at [www.rebuilding93.com](http://www.rebuilding93.com). This website link provides the traveling public an Internet location to view the messages displayed on the message signs, the speeds measured through the work zone and an image of the traffic on I-93.

The volume, speed and queue (length of stopped or slowed vehicles) data will be collected and used by the NHDOT to evaluate the impact of the work zone on traffic in this portion of the I-93 corridor.

-XX-

Public Information Office - P.O. Box 483 - 7 Hazen Drive - Concord, New Hampshire 03302-0483  
Telephone: (603) 271-6495 Fax: (603) 271-3914 web address: [www.nhdot.com](http://www.nhdot.com)

Figure 15. Example press release for a work zone in New Hampshire.

Source: New Hampshire DOT

### 3.7 Investigating system security

Agency staff need to take system security into consideration to ensure that access to the ITS application is protected from unauthorized intrusion. System security is especially critical for systems providing traveler information. Most COTS and permanent ITS deployments rely on a multi-level architecture that grants varying levels of access to the system, depending on the attributes of the user. Some users, for example, will be granted the ability to review the system operating conditions on a website, but not be able to change operational strategies or access more detailed data. Other user may be designated managers of the system, and be allowed to make certain changes to the system. Typically, one or two users may be designated as the system administrator, with the greatest level of access and control privileges granted to them.

In addition, agencies also need to consider the vulnerability of the system's physical components. Sturdy locks and strong passwords should be placed on cabinet doors and computer access points, respectively, where possible. All keys and passwords for the equipment should be stored away from the devices. Also, many agencies position devices in locations where it is difficult for thieves to access and steal the device. Although these are basic security procedures, several locations around the country have experienced security violations where PCMS were programmed to display a false message (see Figure 16), which was made possible by easily guessable or visible system passwords. Easily portable components, such as solar panels, trailer tires, and barrels with sensors have also been stolen. Advances in global positioning satellite (GPS) and other technology in recent years has made monitoring and tracking of equipment easier, reducing theft and vandalism problems.



Figure 16. PCMS in several states have been illegally accessed and had messages changed.



#### Example: Work Zone ITS Security Issues.

Vandalism was a problem on the I-40 reconstruction project in West Memphis, Arkansas. Although securely locked, the control center trailer was broken into by vandals, who ripped the system wires from their connections and destroyed the monitor for the computer. The vandalism resulted in several days of downtime while a replacement computer was sent from the system developer, and damaged wiring was reconnected.

At a separate project in Illinois, a set of portable traffic sensors was stolen. However, officials used the location tracking technology built into the device to identify their location in the thief's garage, making apprehension and recovery of the equipment by local law enforcement personnel very easy.

### 3.8 Planning for evaluation

Evaluation is the rational assessment of how well system goals and objectives are being achieved, and it is an essential ingredient in good project management. The most effective evaluations occur when the goals and objectives for a work zone ITS are explicitly stated, measurable, and agreed to by all stakeholders. Considerations for evaluation at the early stage of the project, particularly during concept development and development of requirements, can greatly facilitate subsequent evaluation of the system. Although evaluation should be considered during each step of the process, formal planning for evaluation cannot occur until the system is well defined.

The primary purposes of evaluations are to:

- Identify changes needed to fine tune and optimize existing system operation or design and improve performance. In this way, the deployment is more likely to meet or exceed established goals and objectives.
- Understand and quantify the benefits of the system, which can help to identify future work zone ITS investment decisions (by documenting conditions for a successful implementation).
- Document lessons learned.

Planning for evaluation should begin with a determination of the appropriate scope for the evaluation. The scope for the evaluation establishes the extent of the assessment (e.g., effort, level of detail, how frequently evaluation will be done for the project) and might be based on the complexity of the system, as well as the duration and scale of the project.

Quantifying benefits need not be overly complex: for example, a North Carolina Smart Work Zone system was observed to have fewer crashes compared to other work zones without the technology.<sup>34</sup> Another example of quantified benefits was documented in the case of a California automated work zone information system that reduced traffic demand through the work zone, having a maximum average peak delay 50 percent lower than expected.<sup>35</sup> Public satisfaction is also valuable, and comments and feedback from the public can be a useful gauge of the value of a system. In Little Rock, Arkansas, for example, 82 percent of drivers surveyed agreed that an Automated Work Zone Information System improved their ability to react to slow or stopped traffic.<sup>36</sup>

An evaluation includes, at a minimum, periodic monitoring of the data and analysis of performance measures, which necessitates a plan to collect and archive relevant data to adequately assess system performance. For example, an evaluation of a traveler information website might include counting hits or user sessions. Tracking visitor sessions or “visits” to the website is recommended as a tool to easily compare between sites. Trends on website usage may also assist in evaluating other facets of the work zone project, such as the effectiveness of a public awareness campaign and whether a website is a good investment that should be included on future ITS deployments.

Evaluation can benefit the agency responsible for the deployment of the work zone, as well as the traveling public. The lessons learned can be used for adjustments to the current system and can also be incorporated into future work zone applications. By framing a plan for a robust evaluation early, an agency can plan data collection activities, rather than piecing together available shreds of data after the project. This is also a time to consider data needs for agency process review. In addition, evaluation results can serve as a valuable resource for other agencies and planners. In general, the need exists for more data collection to better quantify benefits. Ensuring that work zone ITS will archive data in a format and level of completeness to allow the analyst to drill down to detailed impacts will allow agencies to better quantify those types of impacts, and develop strategies to minimize their occurrence in the future.

Several FHWA documents provide useful guidance for the use of work zone safety and mobility performance measures. First, *A Primer on Work Zone Safety and Mobility Performance Measurement*<sup>37</sup> offers information for understanding data requirements for generating useful performance measures. A companion document, the *Work Zone Performance Measures Pilot Test*<sup>38</sup> summarizes lessons learned through the identification and testing of a candidate set of work zone mobility-related performance measures at five projects nationwide. A third document, *Guidance on Data Needs, Availability, and Opportunities for Work Zone Performance Measures*<sup>39</sup> provides more in-depth information and guidance on the usefulness of various measures, and the data necessary to develop and use them effectively.



#### Tip: Helpful hints for planning an evaluation.

- Evaluations can be either qualitative or quantitative; however, the best evaluations employ a combination of both types of information.
- Examining the role of research in the evaluation step of the project will help clarify the types of analyses that can be performed to produce benefits data.
- The most effective evaluations occur when the goals and objectives for a work zone ITS are explicitly stated, measurable, and agreed to by all stakeholders.
- It is helpful to provide a mechanism for the public to offer feedback on the project. Several agencies have used comment sections on the project websites to collect this feedback.
- The formality and magnitude of an evaluation should match the level of the ITS deployment. An informal evaluation may be sufficient for simple systems, while a more formal evaluation would be better suited for a larger-scale deployment.

The ITS JPO at USDOT has developed a six-step process for evaluating ITS projects, which is shown graphically in Figure 17, and should be considered at this stage of the project. Some of these steps will be carried out later during and after system deployment, but the planning should occur now.

<sup>34</sup>Additional information can be found at: <http://www.itsbenefits.its.dot.gov/ITS/benecost.nsf/ID/AAD0A64995FF6FFA8525733A006D5298?OpenDocument&Query=Home>.

<sup>35</sup>Additional information can be found at: <http://www.itsbenefits.its.dot.gov/ITS/benecost.nsf/ID/F1F2919AE17E081285257172005C8569?OpenDocument&Query=Home>.

<sup>36</sup>Additional information can be found at: <http://www.itsbenefits.its.dot.gov/ITS/benecost.nsf/ID/76C9F2DE2BF5DB1D85257603004E031D?OpenDocument&Query=Home>.

<sup>37</sup>This is available online at: <http://ops.fhwa.dot.gov/wz/resources/publications/fhwahop11033/fhwahop11033.pdf>.

<sup>38</sup>This is available online at: <http://www.ops.fhwa.dot.gov/wz/resources/publications/fhwahop11022/>.

<sup>39</sup>FHWA-HOP-13-011, February 2013, [http://www.ops.fhwa.dot.gov/wz/decision\\_support/performance-development.htm](http://www.ops.fhwa.dot.gov/wz/decision_support/performance-development.htm).

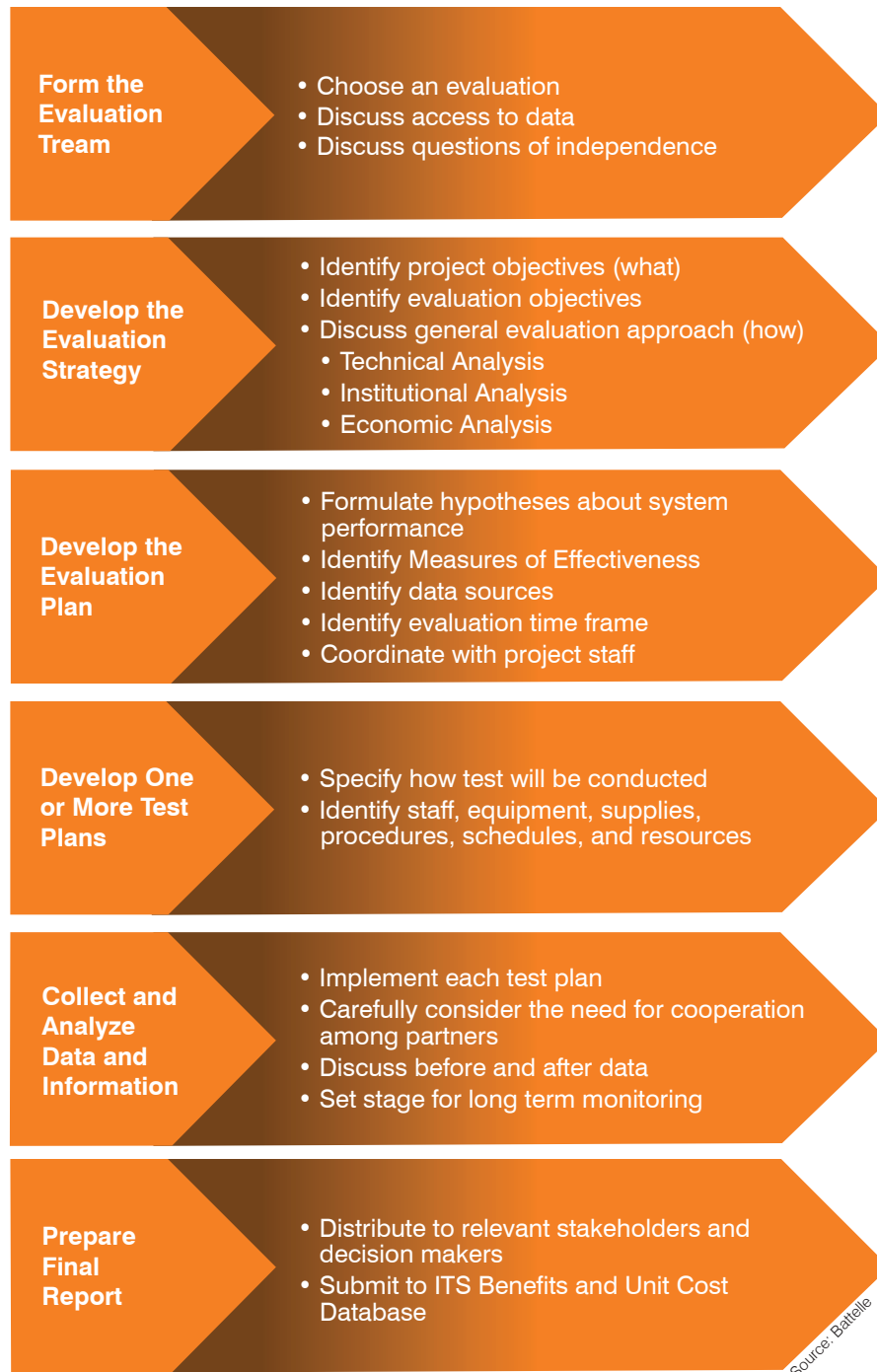

Figure 17. Overall evaluation process for ITS applications in work zones.

The *ITS Evaluation Resource Guide*<sup>40</sup> contains a more detailed explanation of this six-step process, as well as a discussion of evaluation measures that correspond to overall ITS goal areas – safety, mobility, efficiency, productivity, environmental impacts, and customer

satisfaction. Sample evaluation strategies, evaluation plans, test plans, and final reports are also available for downloading from the website. Table 8 presents some example criteria that might be used for a work zone ITS evaluation.

<sup>40</sup>Available online at: [http://www.its.dot.gov/eval/eguide\\_resguide.htm](http://www.its.dot.gov/eval/eguide_resguide.htm).



Table 8. Example evaluation criteria.

Evaluation Objective	Hypothesis	Measures of Effectiveness	Required Data
<b>Mobility</b> – Reduce delay and optimize travel times through the construction corridor by providing advanced traveler information	The ITS will reduce travel time through the corridor during construction.	<ul style="list-style-type: none"> <li>• Change in travel time over baseline conditions in the primary direction during construction</li> <li>• Change in the overall corridor-wide travel time reliability</li> <li>• Change in travel time on recommended or viable alternate routes</li> </ul>	<ul style="list-style-type: none"> <li>• Observed corridor travel time during construction</li> <li>• Observed travel time variability</li> <li>• Observed alternate route travel times during construction</li> <li>• Observed queue lengths before and after ITS on mainline routes</li> </ul>
<b>Safety</b> – Improve traveler safety in the construction corridor	The ITS implementation will reduce crash risks during construction.	<ul style="list-style-type: none"> <li>• Changes in the number of crashes or crash severity occurring in the corridor</li> <li>• Changes in speed variability along the corridor during construction</li> <li>• Change in the number of conflicts that occur in the corridor during construction</li> </ul>	<ul style="list-style-type: none"> <li>• Historical crash data</li> <li>• Real-time crash data</li> <li>• Observed speed variability during construction</li> <li>• Observed number of conflict situations occurring during construction</li> </ul>
<b>Customer Satisfaction</b> – Improve travel satisfaction for corridor users during construction	The ITS will result in improved satisfaction among corridor users.	<ul style="list-style-type: none"> <li>• Corridor traveler perceptions</li> <li>• Corridor traveler behavioral response to system components</li> <li>• Update frequency and perceived accuracy of provided information</li> </ul>	<ul style="list-style-type: none"> <li>• Opinions of corridor travelers serving on a panel survey</li> <li>• Traffic volumes on alternate routes and mainline</li> <li>• Wide distribution of customer satisfaction surveys</li> </ul>
<b>Institutional</b> – Improve coordination among implementing agencies.	The ITS will result in improved coordination among implementing agencies.	<ul style="list-style-type: none"> <li>• Number of institutional issues</li> </ul>	<ul style="list-style-type: none"> <li>• Documented institutional issues</li> </ul>

Source: Battelle

### 3.9 Estimating system benefits and costs

A key part of system planning is estimating system benefits and costs. In estimating the benefits that the system will have on traffic, mobility and safety are both key factors to consider. Estimation of these impacts will become easier as results become available from more ITS in work zone deployments. At present, traffic modeling and traffic flow theory can be used to estimate impacts on delay through factors such as diversion of traffic around the work zone. The level of effort spent to evaluate potential system impacts should be proportional to the size, duration, and complexity of the work zone. A complex 25-mile, 3-year work zone would require a more extensive evaluation of system impacts than that for a simple 1-mile, 2-month work zone. In

estimating system impacts, it is important to consider the whole area that the ITS deployment will influence (see Figure 6).

By this stage, the general cost estimates developed in Step 2 can be refined based on better-defined system characteristics. When refining cost estimates, agencies should be sure to consider ancillary costs such as required training, agency labor, outreach activities, and system maintenance. It is also recommended that agencies include a reserve or contingency fund to pay for unexpected items, such as fixing system integration and communications problems (e.g., costs for cellular modems and pagers, etc.).



System costs will vary widely depending on whether the system is purchased or leased, and whether labor associated with operating and maintaining the system is provided internally by agency staff or by an outside contractor. These procurement options and issues will be discussed further in the next section.

The ITS JPO maintains an ITS Benefits and Unit Cost Database to assist users with estimating system and unit costs of ITS elements and deployments across the country.<sup>41</sup>

### Key Takeaways

- The main products of Step 3 are detailed system plans that build on the concept of operations from Step 2. The concept of operations describes the objectives of the system and how it would operate to achieve the objectives. Step 3 develops the system requirements and specifications that define what the system will do and ideally include performance targets.
- Documentation should include plans for system testing, operating the deployed system, the staffing approach, any necessary public outreach, system security considerations, and evaluation throughout and at the conclusion of the project. It is important to plan for each of these aspects to avoid issues later with system deployment and to ensure that data will be available for system evaluation.
- The most effective evaluations occur when the goals and objectives for a work zone ITS are explicitly stated, measurable, and agreed to by all stakeholders. Then it is much easier to pick appropriate performance measures for evaluation and to know what data to collect to best determine system success and value.

<sup>41</sup>The database is available online at: <http://www.benefitcost.its.dot.gov>; the website has instructions on how to contribute.



The objective of Step 4 is to procure the work zone ITS. This requires first considering a number of options, based on the type of deployment being procured. Sub-steps to developing the plan are depicted in Figure 18.

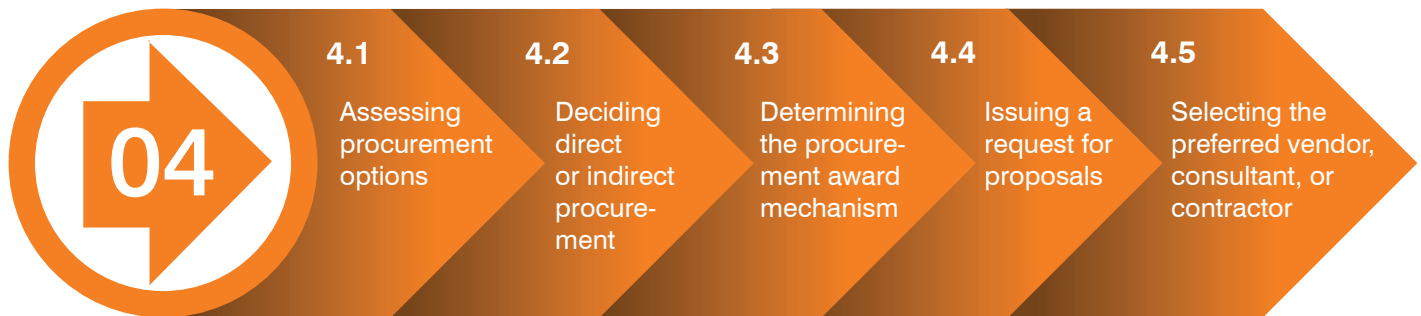

Figure 18. Sub-steps to be explored in Step 4.

Source: Battelle

### 4.1 Overview of procurement approaches

In many ways, the procurement options available for work zone ITS depends on the characteristics of the ITS needed. Traditionally, ITS procurement for work zone applications has primarily been for either COTS or customized ITS solutions. An agency or contractor would obtain the equipment, software, and operational expertise to gather, process, and use data to monitor conditions, measure performance, disseminate information to drivers, and otherwise manage traffic through and around the work zone. However, the potential now exists for agencies and contractors to purchase data collected by private-sector data providers for similar purposes.

An agency can *directly* procure ITS equipment, services, and/or data for its own use and dissemination as part of work zone safety and mobility management efforts, or can procure these items *indirectly* through specification of the ITS needs as part of the roadway construction or maintenance contract. A number of alternatives then exist within these two basic approaches. These approaches and alternatives are described in the following sections. It is important to realize that the type of work zone ITS selected will influence the procurement options, which will impact the choices for procurement award mechanisms in the next step, as shown in Figure 19.

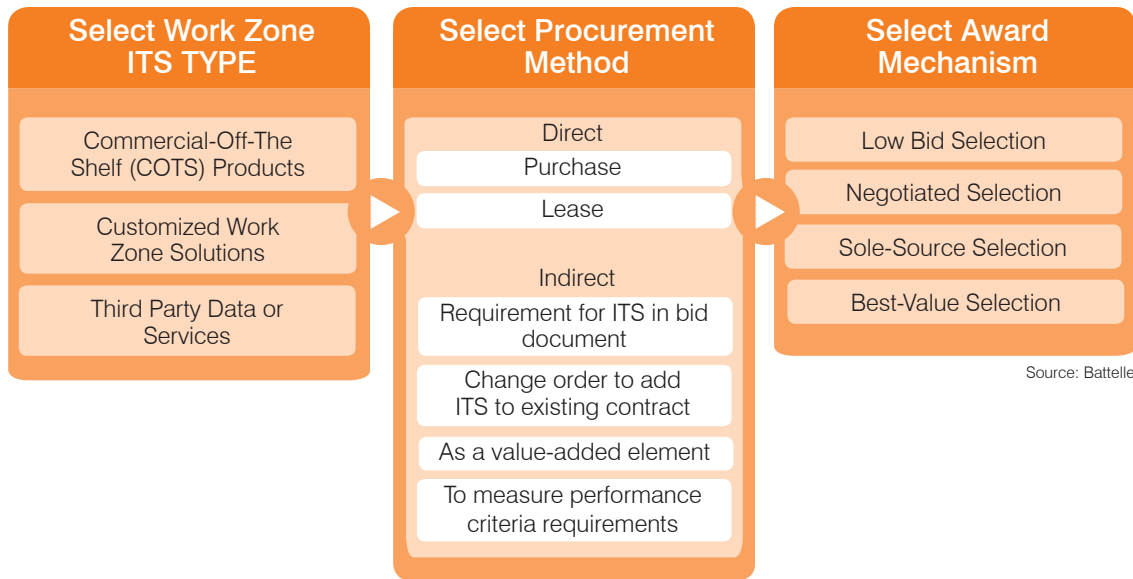

Figure 19. Agencies must select the work zone ITS type first, which could impact the type of procurement method and award mechanism that are used.

### Procuring private-sector data

The procurement of private-sector data is a relatively new approach for agencies. Two types of private-sector data providers exist:

- Private-sector information providers that supplement their motorist travel time information to meet agency needs; or
- Vendors who install, operate, and maintain sensors for the agency and provide the data from the sensors to the agency in the desired format.

The first type is the private-sector information service providers who focus on providing real-time travel time information to drivers on an ongoing basis. These providers typically rely heavily on probe-based travel time data sources, and have developed sophisticated data fusion and travel time and congestion location

dissemination capabilities. Recently, these providers have begun marketing their data to agencies who wish to establish or supplement traffic condition monitoring or performance measurement capabilities on various routes in their jurisdiction. In essence, these companies license the data to the agencies rather than sell the data, as restrictions often exist in how the data can be used or distributed by the agency.<sup>42</sup> As of 2013, the number of contracts (non-work zone) established to obtain this type of data has been limited and is generally negotiated between the data provider and the agency. In one example, the agency paid \$800 per mile per year for access to the data in real time (plus an initial \$200 per mile the first year).<sup>43</sup> If the agency is only interested in historical data (for computing a priori work zone performance metrics as an example), it is anticipated to cost less to have access to the data.<sup>44</sup>

<sup>42</sup>Turner, S. et al. *Private Sector Data for Performance Measurement – Final Report*. Report No. FHWA-HOP-11-029. FHWA, U.S. Department of Transportation, Washington, DC. July 2011.

<sup>43</sup>Middleton, D. et al. *Synthesis of TxDOT Uses of Real-Time Commercial Traffic Data*. Report No. FHWA/TX-12/0-6659-1. Texas Transportation Institute, College Station, TX. January 2012.

<sup>44</sup>Edwards, M.B. and M.D. Fontaine. Investigation of Travel Time Reliability in Work Zones with Private-Sector Data. *In Transportation Research Record: Journal of the Transportation Research Board* No. 2272. TRB of the National Academies, Washington, DC. 2012. pp. 9-18.

The second type of private-sector data availability involves the installation, operation, and maintenance of sensors at locations requested by the agency. This type of private-sector data allows the agency to leverage private-sector experience, supplement existing resources, and lower agency risk. One vendor offered bi-directional spot speed data to agencies for \$110 per location per month in 2012, providing all installation, operation, and maintenance of the sensors, and providing the data in the format designated by the agency.<sup>45</sup>



**Key Point: Procurement of ITS need not conform to a traditional approach.**

The Minnesota DOT issued a stand-alone, design-bid-build, best-value contract to facilitate work zone ITS for a set of three simultaneous construction projects with separate contractors on a single stretch of highway. This mechanism helped assure contractor qualifications and expertise for designing, deploying, and operating a single, quality ITS, along with performance-based considerations for the projects.

The Minnesota DOT has also discussed issuing a general contract to have an ITS contractor on call. The ITS contractor would engage stakeholders and provide input and recommendations for work zone ITS early on for selected projects the agency believes will require it, stay abreast of rapidly changing technologies, and help the agency use ITS to its maximum potential.

## 4.2 Deciding between direct or indirect procurement

### Direct Work Zone ITS Procurement Approaches

An agency has the option of directly **purchasing** work zone ITS from a vendor or consultant, or **leasing** it. The difference between these two approaches is in the duration of availability of the equipment/service/data, and who owns it, and in the operations and maintenance responsibility.

**Purchase:** The agency owns the equipment/service provided/data and is free to use it for as long as deemed necessary. An agency typically also has the responsibility for maintenance of the system, and replacement of any components that become inoperable due to accidents, wear, or neglect. This maintenance could be performed by in-house staff if properly trained, or purchased from a service consultant.

**Lease:** The vendor owns the equipment/services provided/data, and the agency obtains the equipment/service/data for a predetermined length of time (i.e., the term of the lease). When that term is completed, the

vendor retains ownership of the equipment and access to the services/data end. Maintenance, and possibly operations, efforts are handled by the vendor and incorporated into the lease price.

In determining whether to purchase or lease work zone ITS, an agency must consider the following:

- Anticipated duration of usage;
- Whether the agency expects to use similar equipment on future projects and when;
- Expertise on staff to operate, troubleshoot, and maintain the system;
- Reliability of the equipment hardware and software being considered;
- Source of funds to be used; and
- Agency policies and regulations.

Purchasing work zone ITS is sometimes an agency's preferred approach. Longer duration work zones, or the desire to use ITS on multiple work zones that are scheduled in sequence, often make purchasing more cost-effective than leasing. Similarly, purchasing is usually more appropriate for deployment of equipment that is integrated into a permanent regional ITS and will remain as part of that system after the work zone is completed.

For other situations, leasing work zone ITS is the preferred option. The procurement of private-sector traffic data by an agency will almost always be a leasing arrangement unless already available for use through existing contracts for permanent applications. Agencies that do not have expertise on staff to support the operation and maintenance of a work zone ITS deployment may be better served by leasing it and relying on the vendor to provide that expertise. These contracts can specify and restrict allowable downtime when issues with the system arise, levying fines or reduced reimbursement if the ITS deployment has not resumed operations by a certain time. For COTS deployments, leasing does appear to be the preferred method of most vendors and many agencies. Maintenance and removal by a vendor puts the responsibility for proper operation, quality control, and updating of equipment/using newer technologies on the vendor.

Most agencies allocate their available transportation funds into different categories for different purposes, with restrictions on how those funds can be used (much of the federal funding received by state agencies has restrictions on how it can be used as well). Some funds

may only be used for capital equipment purchases, for example, whereas other funds may be designated for operations and maintenance purposes with a restriction that such funds cannot result in agency ownership of any capital equipment.

Agencies typically also follow different procedures depending on how the specific work zone ITS deployment is categorized. For example, it may be feasible to either purchase or lease a COTS system because it can be procured through a traditional low-bid process. However, a customized deployment that requires system design support as well as software design and integration, could be categorized as an information technology project and be subject to additional procedures and regulations and may not be suitable for low bid.

### Indirect Work Zone ITS Procurement Approaches

In addition to the approaches available for agencies to directly procure work zone ITS, there exist a number of approaches where agencies can indirectly procure it. With indirect procurement, in most cases, the actual procurement (purchase or lease) is done by the construction contractor rather than the agency, and thus the agency would not be directly responsible for the later substeps in the procurement process, or even in Step 5 for the system deployment or Step 6 for system operations. Instead, for an indirect procurement approach the primary responsibility of the agency will be in oversight of the work zone ITS and evaluation of the system both throughout and at the conclusion of the project. The indirect procurement methods include the following:

- Line item specification or special provision of the desired ITS functions or components in the original bid documents;
- Change order addition during the project to achieve the desired ITS functions or components (via specification or special provision);
- Assigned additional value to work zone ITS components included within best-value bid proposals (such as for design-build projects); and
- Incorporation of traffic performance requirements into the bid documents that could be monitored through the incorporation of work zone ITS.

The first two approaches above would ensure that ITS is deployed, while the latter two approaches may (but not necessarily) result in an ITS deployment.

One of the most common ways for ITS to be indirectly incorporated into a work zone project is for the agency to specify through a line item in the bid documents that it be provided as part of the contractor requirements

for performing the work. This approach requires a specification or special provision outlining the purpose, functions, and possibly operational requirements of the system (e.g., messages to be presented on PCMS, speed thresholds at which different messages are to be displayed, response time and maintenance requirements such as allowable downtime before penalty when issues arise, etc.). The contractor has the option for either purchasing or leasing the system. Overall, vendors prefer for specifications or special provisions to be very precise in the types and amount of equipment to be procured, as it allows them to be competitive when providing bids. However, agency personnel tasked with establishing the specification or special provision often do not have the technical expertise to create such a precise specification without unduly biasing it towards a particular type of technology or vendor. The actual system to be procured by the contractor and the amount to be paid by the agency to the contractor may be accepted initially by the agency, or may be part of negotiations between the agency and the contractor selected. Agencies should also be aware that if a project is delayed that specifications may need to be updated prior to issuing a request for bids to ensure it addresses current needs and system options.

Another way for ITS to be indirectly procured by an agency is by issuing a change order to an existing contract to add the system. This approach is used when the need or value of an ITS deployment is identified after the initial construction contract has been awarded. A change order may also be needed to further enhance the equipment or capabilities of ITS that have already been deployed. Like a line item bid approach, a specification or special provision is needed for bidding purposes. Both purchase or lease options are again possible, and different approaches can be used even if the change order is an addition to an already-deployed system (e.g., a system initially purchased could be enhanced through the leasing of additional equipment procured through a change order). This approach can result in slightly higher costs than those obtained during the initial project bid, as the contractor attempts to account for the additional time and cost to his or her operations in executing the change order.

A third indirect method of work zone ITS procurement is through the assignment of value to ITS deployments proposed as part of a design-build or best-value bidding process. (Note that the fourth method, the specification of performance criteria, may be included in a design-build process also.) For this approach, a consultant-contractor team develops needs, objectives, and methods for deploying work zone ITS and incorporates a proposed plan for the ITS deployment into their bid. The agency then considers the value of the proposed work

zone ITS deployment, typically using a point system and assessment process. Ideally, the value and scoring criteria that the agency uses in proposal evaluation would be based on the agency’s assessments of expected impacts that could occur during the project and the potential for the proposed ITS deployment to mitigate those impacts. It is important to note that this approach may not result in an actual ITS deployment, since a winning contractor or contract team may not be one that actually proposes the use of ITS.

The fourth and final method of indirect work zone ITS procurement involves specification of performance criteria in the construction contract alongside a requirement for the contractor to verify said performance. In this case, the contractor (or subcontractor) determines the best approach to meet and verify performance requirements. Although this approach would not

specifically require that ITS be used, the contractor could decide that an ITS solution is the best or only approach towards meeting the requirement of monitoring performance. This method would be best suited for well-defined mobility measures, such as maximum travel times or delays allowed. Agencies would designate any incentives to be awarded if monitored impact thresholds are maintained, as well as any penalties that will be incurred if such thresholds are exceeded.

A listing of the key advantages and disadvantages of each of the procurement approaches are summarized in Table 9. Theoretically, indirect procurement could involve equipment/COTS systems, data from third-party vendors, or a combination of both. To date, indirect procurement has involved mainly ITS equipment, particularly COTS systems. However, a more complex approach is certainly possible. For instance, a

**Table 9. Summary table of procurement methods.**

	Method	Key Characteristics
Direct Agency Procurement	Purchasing	<ul style="list-style-type: none"> <li>• Can be most cost-effective approach for very long duration projects or when system is to be re-used on other projects</li> <li>• Necessary when components are to be integrated into permanent regional ITS and retained after the work zone is completed.</li> <li>• Agency has maximum control over the system</li> <li>• Data licensing agreements for private-sector data can involve some restrictions on use and dissemination</li> </ul>
	Leasing	<ul style="list-style-type: none"> <li>• Agency limits or eliminates need for ongoing maintenance and updating their technology</li> <li>• Agency not required to maintain expertise on staff for set up, troubleshooting, maintaining, and updating equipment</li> <li>• Maintenance and removal by vendor allows them to ensure proper operation, quality control over equipment used, and up-to-date equipment</li> <li>• A preferred method by vendors and agencies for COTS deployments</li> <li>• Direct engagement with vendor keeps high focus on work zone ITS</li> </ul>
Indirect Agency Procurement	Specific requirement for ITS in bid documents	<ul style="list-style-type: none"> <li>• Contractor has responsibility for determining and selecting a vendor (agency does not make vendor selection)</li> <li>• Contractor determines whether to purchase or lease the system</li> <li>• Agency can retain ability to negotiate with the contractor regarding pricing and other aspects of the ITS deployment</li> <li>• Agency does not have direct link to vendor to provide input on set-up and adjustments during operation</li> </ul>
	Change order to add ITS for existing construction contract	<ul style="list-style-type: none"> <li>• Contractor has responsibility for determining and selecting a vendor (agency does not make vendor selection)</li> <li>• Contractor determines whether to purchase or lease the system</li> <li>• Agency can retain ability to negotiate with the contractor regarding pricing and other aspects of the ITS deployment, but may cost more than including it in the original contract</li> <li>• Enhancements to existing work zone ITS by a contractor can be procured by a different approach than used for the original system (purchase versus lease)</li> </ul>
	As a value-added element	<ul style="list-style-type: none"> <li>• Design-build or contractor team develops ITS needs, objectives, and methods and may not have all the traffic data to tailor the ITS</li> <li>• Agency determines value of the proposed ITS deployment, and considers it within the overall transportation management approach being proposed</li> <li>• Winning contractor or contract team may not propose an ITS solution</li> </ul>
	To measure performance criteria requirements in a contract	<ul style="list-style-type: none"> <li>• Contractor decides best approach to meet the defined need to monitor impacts</li> <li>• Monitoring of impacts is commonly tied to incentive and/or disincentive clauses that depend on whether or not the impacts exceed a threshold</li> <li>• System may or may not be used to improve traffic operations</li> </ul>

Source: Battelle



contractor could, in cooperation with the highway agency, choose to purchase travel time data from a third-party data provider in real time with the intent to disseminate that information via portable or permanent CMS in advance of the work zone. Dissemination could involve manual monitoring of the data coming in from the third party and creation/posting of the travel times, or could potentially even be automated.

### 4.3 Determining the procurement award mechanism

Historically, ITS procurement has been accomplished through various award mechanisms, depending on the type of system needed. These mechanisms include:

- Low bid selection (commonly referred to as sealed bidding);
- Negotiated selection (based on evaluation of a technical approach, qualifications, and experience submitted as a proposal);
- Sole source selection (to obtain services or equipment when no competitors exist); and
- Best value selection (a weighted combination of the low-bid and negotiated selection mechanisms).

Often, direct procurement of COTS systems can be safely awarded through low-bid mechanisms, whereas more complex customized solutions and private-sector data are usually procured through one of the other mechanisms. The effectiveness of low-bid selections depends significantly on the quality of the bid specification itself. As noted previously, specifications that are too prescriptive technology-wise can result in only a single bidder (if the bidder is aware that they are the one, this can result in a higher bid price). On the other hand, specifications that are too general can result in procurement of lower-quality, less durable equipment or systems.

For indirect procurement through line item project bids or change orders, however, a COTS procurement will often be a negotiated or best-value selection. In some instances, a contractor may simply identify a work zone ITS vendor they prefer to work with, which could be considered a type of sole-source procurement. However, most agencies will include provisions in the bid documents to approve the system and vendor, as well as to limit the amount by which the contractor can increase the bids for profit purposes. The proposal of a work zone ITS as a value-added feature for a particularly large complex design-build project has occurred in a few instances in recent years, and may become more commonplace in the future as agencies develop procedures on how to objectively consider the value of these features in the overall bid package. Theoretically,

the project bid document could require a contractor to provide multiple bids from work zone ITS vendors and to select the low-bid option. To date, however, it does not appear that many agencies are willing to be so prescriptive, relying instead on the contractor to work up their best price with a vendor they feel gives them the best opportunity at being successful and profitable.

Although there has not been a significant amount of experience with procuring data from third-party vendors specifically for work zone purposes, it would seem that all of these approaches would be valid for work zone data procurement as well, depending on the location of the work zone (e.g., third-party data is not always sufficient on lower-volume facilities or for overnight hours).

### 4.4 Issuing a request for proposals or bids

After the procurement award mechanism has been selected, the agency has everything necessary to procure the system if the agency is directly procuring the system or system components. For a complex, uniquely designed system, this may involve the development and issuance of a request for proposals (RFP).

The RFP should contain clear specifications for the system, including any additional resources needed for operations and maintenance. The products of previous steps should contain all of the information necessary for inclusion to the RFP. The system requirements and system design are particularly important items to include, as is the testing strategy in order for the contractor to understand the desired system.

The structure of a given RFP will vary greatly based on a number of factors. Depending on the extent to which the agency plans to operate and maintain the system, staffing needs and maintenance considerations should also be included in the RFP document. It could be valuable to consult with several vendors or contractors in advance to research various options available in order to draft.

A separate consideration is the option of hiring an independent evaluator of the ITS deployment. An independent evaluator can assist an agency with making an unbiased comprehensive assessment of the deployed system. If an independent evaluator is preferred, this will be done through a separate RFP process. It is recommended that the contract be awarded early enough for the evaluator to make recommendations for data collection or documentation throughout the implementation.

If the need is more for a COTS system by the agency for which the agency has a good idea as to the functions, devices, and operating criteria to be used, a request-for-bid may be used in lieu of the more complex RFP for an agency's direct purchase. In these situations a purchase specification of the desired components and performance of the system are issued for vendors to follow. In a request-for-bid approach, lowest cost typically controls the award selection.

When a work zone ITS is to be procured indirectly, as part of an overall construction contract, the contractor has the primary role in determining what to provide. For these situations, the agency will normally include a special specification in the overall bid package. It is then up to the contractor to identify the technology, system, and if necessary, subcontractor to help meet the specification. Depending on how the specification is written, the agency may have some opportunity to work cooperatively with the contractor in selecting the ITS technology and subcontractor. Typically, this collaboration occurs more often once a contractor determination has been made, so as to keep from influencing the overall bid process.

#### 4.5 Selecting the preferred vendor, consultant, or contractor

For direct work zone ITS procurements by the agency that involve an RFP, the next step is for all proposals that have been received to be evaluated by the agency and the winning proposal selected. The review team should verify that the proposed system will meet the required objectives for the needed ITS before delving further into the details of the proposal and evaluating it. It can be helpful to include someone with ITS and traffic management expertise who is familiar with the project TMP on the review team.

The final selection of the winning proposal should be based on the award mechanism established in substep 4.3 using the criteria established in the RFP in substep 4.4. Generally, the specified set of criteria from the RFP is used by those evaluating the proposals to rank the proposals in various categories. If the proposal includes additional elements, these can be considered for the potential value added to the required system in comparison to the higher costs that may be incurred, depending on the award mechanism. This may be particularly applicable for best value or design-build (DB) procurements.

Upon selecting the winning proposal, notification should be sent to the contractor with clear guidance regarding next steps. This should include information regarding a kick-off meeting. A kickoff meeting provides a forum to

discuss schedule information, expectations regarding system deployment and agency communications, and any changes that have occurred since the RFP was issued.

For simpler procurements, such as for a direct agency procurement of a COTS system for which a purchase specification and request-for-bid was issued, the process is very straightforward. The agency first verifies that the specifications included in the request-for-bid can be met by the vendors providing a bid, and then selects the lowest bid from those deemed to be acceptable.

Finally, procurements of a system or system components indirectly by a contractor as part of the overall contract may or may not involve the agency as part of the selection process, depending on when the procurement process is initiated (i.e., as part of the initial bid package or through a change order) and how the bid specification was crafted. Desirably, some level of involvement is incorporated into the bid specification (such as the requirement that the system be approved by the agency), since few contractors have enough experience with work zone ITS to be able to assess which vendor and/or subcontractor will best provide devices or a system that will best meet the requirements of the specification. Even then, it is still up to the contractor to first find the vendor/subcontractor, and then bring them to the negotiation table to bet agency approval of the selection.



#### Example: Massachusetts Service Contract.

The Massachusetts DOT has entered into a two-year service contract directly with a vendor to deploy, calibrate, and oversee operations of smart work zone equipment at projects as directed by the agency. Emphasis has been on short-duration projects where the Massachusetts DOT is pushing for construction to be accelerated. The Massachusetts DOT purchased the equipment directly and so will retain it at the end of the service contract. The Massachusetts DOT spent slightly more than \$370,000 on three pan-tilt-zoom capable portable camera trailers, nine portable traffic sensors, and three portable changeable message signs. The on-call portion of the contract consists of a \$30/day deployment cost of the equipment, and a \$1,000/month hosting charge for web-based monitoring of the system components.

### Key Takeaways

- In this step, the procurement type and mechanism is determined, an RFP is issued, and a proposal is selected.
- In procuring work zone ITS, there are three different perspectives: the contracting agency that desires work zone ITS, the contractor responsible for the overall construction project, and the vendor who supplies work zone ITS. Lessons learned from each of these perspectives were gathered from five FHWA-sponsored case studies that examined deployments of ITS in work zones in Effingham, Illinois; Mount Vernon, Illinois; Salt Lake City, Utah; Orem/Provo, Utah; and Las Vegas, Nevada in 2012; interviews with agency officials from five States that are active in work zone ITS; and interviews with four experienced work zone ITS vendors. These lessons are provided below.

### General Agency Perspectives

- Methods for estimating potential benefits and costs of work zone ITS are not well developed, such as expected diversion rates, resulting reduction in road user costs, or expected reductions in incident rates. Further, work zone ITS and its estimated benefits must compete for other construction (“hard-dollar”) needs when assessing whether work zone ITS is actually the best use of funds.
- Once implemented, it is often hard for an agency to assess whether the work zone ITS was beneficial. Agencies want equipment to be activated as soon as it is deployed to get the most out of their investment and to preempt liability concerns should an incident occur in the work zone when the system is inactive. If the agency leaves the system turned off to get data for a true “before” condition for comparison, criticism may result for not using equipment that has already been paid for and is supposed to alleviate issues caused by the work zone. Other methods of estimating impacts, such as through simulation models, are time-consuming and are not guaranteed to provide realistic estimates.
- Current agency procurement processes are difficult to apply to bid estimation for work zone ITS because there are not enough unit price experiences. Differences in various system objectives, designs, roadway and work zone characteristics complicate matters in trying to establish average unit pricings.
- Agencies should verify the qualifications of any ITS subcontractors that the contractor may propose or select. Contractors have limited experience with procuring work zone ITS technology and may be more focused on the main project, making the skills and capabilities of the subcontractor critical for a successful work zone ITS deployment.
- A separate ITS contract can allow for a better functioning work zone ITS, since that is the primary focus of the contract. With these contracts, the direct interaction between the agency and the vendor can reduce the time it takes to make the system work properly or make any necessary modifications.

- Language in separate contracts should include provisions for cooperating with adjacent projects since nearby projects may affect the work zone and functioning of the ITS.
- Best value contracts are useful, particularly if the vendor is required to demonstrate past successes and incorporate those proven technologies and strategies in their bid. Vendors with successful past experiences are more likely to reduce the time needed to make the system function properly, which is critical since the first days of deployment are critical to retain driver respect and attention.
- Agency access and use of third-party traffic data can be challenging, as the roadway segments used by the vendor may or may not line up well with actual work zone project limits, or even with how the agency defines segments within its own roadway inventory files.
- If third-party data is obtained for the purpose of post-hoc performance assessment of a work zone, the price of the “historical” data is likely to be relatively low but the data itself may be aggregated to a level that inhibits analyses of detailed work activities (i.e., a temporary lane closure occurring on a particular day or night). Conversely, leasing of real-time data for work zone monitoring and dissemination will typically allow for detailed assessment of specific work zone impacts, but will likely cost more to obtain.

### Construction Contractor Perspectives

- Most contractors have very limited experience with procuring work zone ITS technology, and so many contractors rely on subcontractors for expertise. Generally, the technical knowledge needed for work zone ITS is much different than what normally exists on contractor staff. Contractors need to seek out qualified and experienced subcontractors to ensure that work zone ITS needs are sufficiently met.

- The addition of work zone ITS to a contract through a change order can be daunting for some contractors, who tend to be risk-averse. If the contractor does not have experience with similar issues or work zone ITS, the change order may be resisted and/or priced higher than might otherwise have occurred if included in the original bid documents, and the agency may have difficulty obtaining what was desired.
- Benefits to the contractor of a work zone ITS deployment, such as reduced delivery times or reduced litigation potential, are typically not considered or quantified by the contractor.
- Work zone ITS is often a small piece of an overall construction contract and therefore may not seem to warrant much effort or attention by the contractor.

### Vendor Perspectives

- Not all agencies adequately verify that all required aspects of the bid specifications are met by the selected vendor prior to deployment of the system, or even once the system is deployed. The specification often does not spell out exactly what will happen should the system not meet the criteria in the contract (such as overall accuracy of each sensor, or the accuracy of the overall travel time that is estimated through the system).
- As a result, some vendors may propose on a project even if they are less than fully certain that they meet all the specification elements, since the consequences of not fully meeting the full specification are outweighed by the potential benefit of winning the contract.
- Some vendors prefer bid specifications that specify how much of each type of equipment is to be procured and deployed for a given work zone, so that competitive bids can be developed. Others prefer that the specifications only identify the functions and level of performance required, and allow the vendor to propose the number and location of devices that would meet the specification.
- Agencies who would like to see innovation in best value proposals should consider stating so in the bid documents. Otherwise, best value procurement requirements could restrict vendors from proposing innovative strategies that may be new but untested, given rapid changes in work zone ITS technologies.
- A standalone ITS contract allows the vendor to focus on the work zone ITS, as opposed to an indirect procurement where the contractor has its primary focus on the construction project itself.



### Tip: Strategies for Successful Procurement.

- Agencies need to consider the necessary personnel experience for operating and maintaining work zone ITS before deciding whether to purchase or lease work zone ITS, so that the procured system can be effectively operated and maintained.
- Regardless of whether ITS is procured directly by an agency or indirectly through a construction contract, it is important that there be expertise available locally (either on agency, contractor, or vendor staff) who are tasked with day-to-day responsibility for operations and maintenance of the system to enable quick response and resolution of issues.
- Typically, for indirect procurements it is better to include work zone ITS as part of the construction contract than as an addition through a change order to minimize costs and reduce frustration. In addition, change orders over a given amount or percent on a project may require high-level administrative approval before procurement, which can delay when the system can be obtained and deployed.
- While change orders are not the preferred procurement approach, agencies should also recognize the potential need for change orders to modify or enhance the system once it is implemented and operational experience is gained regarding actual work zone impacts.
- Hybrid approaches that mix two or more of the procurement approaches discussed herein are possible. For example, an agency may choose to purchase a COTS system itself through a low-bid selection process, and then hire a vendor to deploy, calibrate, and operate the system on an as-directed basis through a low-bid or other type of selection process. As another example, an agency could specify that the contractor obtain a COTS system for the purpose of providing queue warning protection upstream of temporary lane closures, considering the payment for the system as a type of mobilization cost. Then, each time the system needs to be deployed, a per-use or per-day fee could be negotiated with the contractor to cover labor costs for deployment, operation, and retrieval.
- In some cases, agencies will specify that project funding will be withheld if ITS components are not maintained in a satisfactory operating condition as one way of increasing its importance with the contractor.
- It is important to remember that 3rd party traffic data collected primarily by vehicle probes can provide good work zone travel time and delay information, but will be less sensitive to the onset of queues that form until the queues reach a substantial length. Only those vendors that can provide spot speed data will be effective for supporting queue detection and warning systems.



# STEP 5

## SYSTEM DEPLOYMENT

The planning, design, and procurement efforts culminate in the actual deployment of the selected work zone ITS. Although considerable effort may have already gone into earlier steps in getting ready for deployment, this is the point at which things can really get busy. Unlike permanent ITS deployments which are typically the objective and focal point of efforts, a work zone ITS deployment must be matched to the overarching goal of completing whatever construction project or projects are necessitating the work zone in the first place. A work zone deployment becomes another cog in the overall project to be coordinated, managed, and otherwise adjusted so as to achieve the main desired goal: to complete the tasks required correctly, on time, and within budget while at the same time minimizing the impacts of those tasks upon the public, especially the traveling public.

As those who have been involved in performing and completing a work zone project can attest, project coordination involves chasing a constantly changing target in many cases. Field changes in project scope, phasing, scheduling, etc. can all affect how a work

zone ITS component fits and will work as a mitigation strategy. Even if such changes in a project do not occur, it is not known for certain how effective a particular ITS application will be until it is deployed. Consequently, field adjustments to the system are often necessary. Additional equipment may be needed because impacts exceed what was anticipated, or system operation may need to be altered to improve driver understanding and response to the system. These changes may be needed immediately upon deployment, or develop when the project changes to a new phase with a different maintenance-of-traffic (MOT) approach. As such, system deployment is not so much as step as it is a process.

System deployment includes initial implementation, as well as scheduling decisions, systems acceptance testing, and handling major deployment issues, as depicted in Figure 20. Deploying the system should be done in coordination with the deployment of other TMP strategies.



Figure 20. Sub-steps to be explored in Step 5.

Source: Battelle



## 5.1 Implementing the system plans

The role of an agency during system deployment depends on the size and complexity of the system, whether it is a COTS system or a unique system designed to address a highly specialized need, and whether it is to operate independently or be integrated into other ITS operational components in the region. For small, COTS systems that are intended to operate independently, agency involvement during deployment may consist of the project engineer and inspectors keeping track of the system and monitoring and validating the information being collected and disseminated. For larger and/or more novel or complex deployments and deployments that involve integration with existing ITS components, the level of agency involvement may span across several offices and divisions, and require significant staff time to test, troubleshoot, validate, monitor, and maintain the system.

Personnel with expertise in ITS deployment must be available through all steps of the deployment. For COTS systems, that expertise often resides with the vendor; for customized system designs, such expertise may need to reside with the agency or the consultant hired to design and oversee the deployment of the system. For customized system designs or deployments that are connected to existing permanent ITS infrastructure, it is also vital that key staff understand the overall vision developed in Step 2 and the requirements defined in Step 3. Subcontractors may look at each requirement individually, but not take into account the overall system vision. Such a “stove pipe” analysis can result in an installation that, while consistent with the literal system requirements, does not support the overall vision and other TMP strategies as intended.

## 5.2 Scheduling decisions

Scheduling can play a major role in the deployment of ITS applications for work. Testing and ultimate system calibration can take longer than anticipated, for example. It is critical that a work zone ITS deployment be available and functioning at the beginning of a project or major phase change for which it is intended, as this is the time when drivers first encounter unexpected conditions and need real-time information.

Scheduling decisions could include:

- **Plan for sufficient lead time to deploy:** Some agencies that are incorporating work zone ITS deployments into their construction contracts require that the system be operating before actual construction work starts. Contractors need to allow sufficient time for this requirement in their overall project scheduling.

Agencies or their consultants who are deploying work zone ITS themselves to support a particular project need to plan sufficient lead time as well.

- **Plan for sufficient calibration time and effort:** Systems that provide real-time travel time and delay information to motorists typically require some level of calibration to fine tune the values presented. Normally, this will need to occur after work and its associated congestion have begun. Efforts should be taken to ensure the availability of staff to assist during the calibration process very early in the project. Continued display of inaccurate travel times or delays will significantly erode credibility of the system with drivers, and make it more difficult to get drivers to react to the real-time information.
- **Consider the potential for the unexpected to occur:** It can be difficult to predict in advance the traffic impacts that a work zone might generate, and thus the amount of coverage needed for a work zone ITS deployment. It can be beneficial for agencies to have contingency plans, or at least have options available to them, with regards to modifying the system slightly. For example, an agency can designate that the contractor obtain an initial work zone COTS system meeting a set of specifications and equipment requirements as part of the original bid process. However, if additional equipment or functionalities are later found to be required, the potential implications for using a change order process to obtain that additional equipment or functionality should be thought through.

Agencies should ensure that as much time as possible be built into the implementation process and construction schedule, especially with regard to system calibration and sensor programming. Systems can be developed and deployed in short timeframes when needed. Additionally, flexibility is important for the ITS deployment schedule due to uncertainties in the construction project schedule. The initiation or conclusion of a construction project, or individual phases of a project, often change due to a variety of factors. While delays may be more common, sometimes projects or project phases can begin or end earlier than planned with only short notice from the construction contractor or agency staff. If ITS changes are necessary between phases, paying closer attention to the schedule is warranted to minimize ITS downtime. On the other hand, the steps outlined in this guide do require time to complete, and so it is important to allow for sufficient time.

**Tip: Allow start-up time when deploying a system.**

Problems will arise—such as the operation of sensors, communications (wireless or wired), calibration, or software—and will take time to address. These “bugs” require time to locate and address. Failure to allow for sufficient start-up time can lead to less than optimal performance of the system during the initial days of the project. Unfortunately, this is often the time at which the system is most needed, as drivers are encountering unexpected conditions due to the capacity and operational constraints imposed by the MOT plan, are surprised, and need and would benefit significantly from having improved information and guidance in how to best accommodate the work zone.

**Tip: Quickly deploying work zone ITS is possible but can require extra resources.**

Although it is desirable to begin the process for considering, planning, designing, and deploying a work zone ITS early in the overall project development process, circumstances sometimes dictate that an accelerated timeline be followed. It is important to recognize when such circumstances arise and to dedicate enough resources to be successful in meeting that timeline. For example, a work zone ITS deployment used on the Big I (I-40) project in Albuquerque, New Mexico, was able to go from concept to full operation in only 15 weeks. However, to accomplish this, the agency had to employ several experienced ITS contractors for the ITS design, system selection, and system installation.

### 5.3 System acceptance testing

Before the work zone ITS is activated, system acceptance testing must be conducted. These tests should be comprehensive to ensure that all system requirements and user needs are met. System acceptance testing will follow the testing strategy proposed in substep 3.3 and will validate the functionality and accuracy of the work zone ITS to make sure the system is working as planned.

Following the test plans from substep 3.3, data sheets should be used to record test data and compare recorded results with expected results. Test reports should be compiled that document how well the system performed and any modifications that need to be made prior to system activation.

As applicable, driver capabilities should be re-examined at this time to verify that the system will be satisfactory from a human factors perspective. Messages displayed on CMS should follow current guidance to ensure that the information is clear, concise, and credible. Characteristics of the devices and their deployment locations should also be checked. For example, the size of the text on a message display must be sufficiently large and visible (a minimum of 18 inch characters for freeway conditions) so that drivers do not have to slow down to give themselves more time to read. Message boards should be checked to be sure they are positioned away from obstructions that might limit viewing times, such as piers, abutments, parked construction equipment, etc.

### 5.4 Handling major deployment issues

Issues identified in system acceptance testing that are likely to affect deployment include problems with communications, power, sensors, and other system components deployed in the field. Communications can especially be a challenge in rural areas. While it is impossible to anticipate every possible contingency that could arise during deployment, availability of staff experienced in the deployment of ITS is one of the best means of mitigating issues that arise during deployment.

The key is to prevent issues from arising in the first place by selecting an experienced/qualified contractor and providing sufficient time within the schedule to handle issues that are not anticipated. Maintaining flexibility is crucial, as unexpected things like parked construction vehicles, construction equipment storage, or law enforcement positioning in front of sensors can cause issues that will need to be addressed. Developing and sustaining good working relationships among project team members are helpful for when issues arise. Frequent communication within the team can also assist in this process by helping to establish a positive working relationship among contractors, ITS subcontractors (if used), and government agencies.

Other issues like construction design or plan changes can also affect the ITS deployment. For example, an initial decision to keep a particular entrance ramp open during a major freeway reconstruction project may be changed based on poor safety performance of similar entrance ramps experienced at an ongoing project immediately upstream. If the initial decision was to deploy a work zone ITS with temporary ramp metering at that entrance ramp, the ramp metering component might need to be eliminated.

### Key Takeaways

- In this step, the work zone ITS is deployed following the system plans, schedule, and system acceptance test plans.
- Coordination of the deployment with other aspects of the project, including other TMP strategies, is important.
- Deployment of the ITS must be considered a process. It should follow the implementation plan developed but be flexible to deal with changes in overall work zone scope and scheduling, unanticipated driver needs and responses, and a wide range of field conditions and actions which could influence system operations. An example of such demonstrated flexibility is evident in the following case study in Salt Lake City.



### Example: Testing performance specifications – Salt Lake City, Utah.

Utah used performance-based specifications for work zone traffic control during a design-build project on SR 154 (Bangerter Highway) in Salt Lake City, developing and implementing a travel time monitoring system that used a Bluetooth address matching system. Utah DOT and the contractor spent a considerable amount of time once the antennas were deployed to fine-tune the overall operation of the system. A number of settings on the devices themselves had to be calibrated depending on how traffic was behaving near the antenna itself. Some of the calibration involved settings on the antenna itself, others in terms of how the data coming in from the detectors are handled during processing. It took the Utah DOT/contractor team a significant amount of time to understand the nuances of the system and to get the system to operate as desired. Another aspect of system operation that took some time for Utah DOT and the contractor to reach a consensus on was the minimum number of Bluetooth matches between antenna locations needed in a given time period to develop a good travel time estimate. Once calibrated, the system worked as intended, and yielded significant benefits to both Utah DOT and the contractor.



This step covers system operation and maintenance and includes sections on dealing with changing work zone conditions, using and sharing ITS information, maintaining adequate staffing, modifying the strategy and plan based on operational results, and leveraging public support, as depicted in Figure 21.

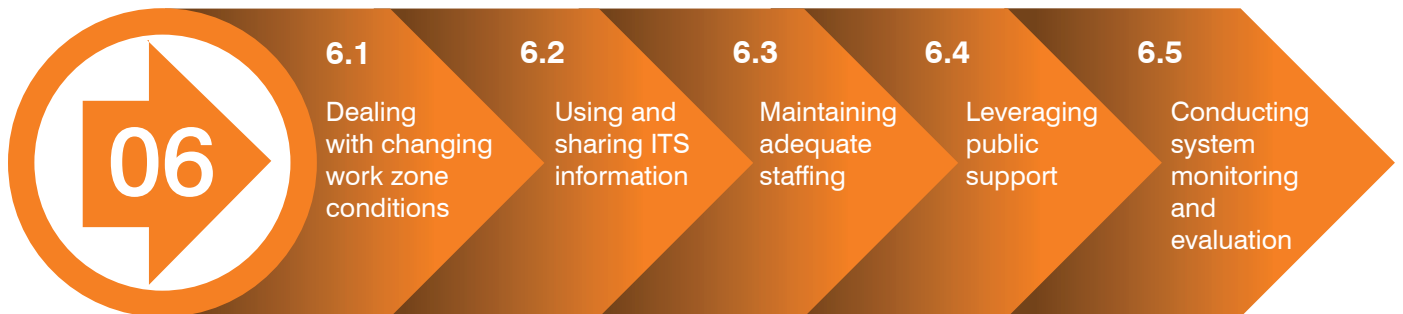

Figure 21. Sub-steps to be explored in Step 6.

Source: Battelle

**6.1 Dealing with changing work zone conditions**

One of the challenges for agencies operating ITS applications in work zones is maintaining system performance while adapting the system to changing work zone conditions and roadway geometries. The system may have to be repositioned or adjusted for various phases of construction that may involve different lane shifts or capacity reductions, for example. Other unexpected activities, such as parked construction vehicles, construction equipment storage, or law enforcement positioning in front of sensors, can cause issues that will need to be addressed in a timely manner.

Flexible and proven work zone ITS that can be dynamic or react in real-time is important for meeting real-time conditions. Not surprisingly, most agencies select highly portable systems built around proven

technologies and wireless communications. Some systems have capabilities to communicate via cellular network or satellite depending on whether or not cellular communication is available in an area.

The provision of power for work zone ITS is another important consideration. Many work zones are located in rural areas that will not have convenient, direct access to power. However, if a wired power source is used, fewer options may be available for moving the system as changes in the work zone arise. Portable systems are typically powered through batteries with solar arrays for charging, or by having vendor staff continuously charging spare components and switching out charged components as needed. Power levels of batteries should be monitored periodically to ensure adequate charge, particularly if overcast conditions may have reduced solar charging.

Supporting a changing work zone requires significant coordination among the construction team, agency staff, and ITS operators. These challenges illustrate the importance of these considerations in system planning in Step 2, as well as developing close working relationships in the earliest stages of the planning process.



**Key Point: Sometimes conditions in the field may differ from what was expected during systems planning and design, and adjustments may be needed.**

For example, queues may be longer or shorter than what was estimated before construction actually started. Personnel should monitor conditions in the field such that if queues regularly extend beyond the system signs (or detectors), the agency/contractor can consider adjusting the placement of the system components to make the most effective use of the system or adding additional devices to extend coverage.

## 6.2 Using and sharing ITS information

Information gathered from the work zone ITS might be used internally for traffic management purposes and to inform the use of other TMP strategies. Information about the work zone may provide insights about adjusting work zone hours, the lane closure schedule, the procedure to identify incidents, or fine tuning of alternate routes, diversion messages, or public outreach efforts.

Additionally, the benefits of the stakeholder relationship-building conducted in earlier stages of the project begin to appear. It is important to keep the stakeholders informed throughout the system operation step to ensure that cooperation and support for the effort continues. Discussion regarding the work zone ITS might be combined with related meetings such as those on maintenance of traffic, which are a venue for sharing ITS information, getting stakeholder input, and coordinating with other TMP strategies and the rest of the project. However, it is also important not to overload stakeholder partners with too much information.



**Tip: Manage expectations.**

It is important to assess and update expectations based on true experiences of the deployment in the work zone. The deployment may have greater or lesser impacts than originally anticipated, and it is important for stakeholders to understand why that is the case.

Work zone ITS differ in how they relay information to travelers via various media for pre-trip (i.e., website, email, text message) or en route (i.e., CMS or PCMS, HAR, in-vehicle navigational aids) decision making. In some systems, this information delivery is fully automated, whereas other systems require human confirmation of current traffic conditions and specific messages. Fully automated systems must be thoroughly and regularly tested to ensure that they are measuring conditions properly and that they are supplying the correct information for those measured conditions. Other ITS must be managed by operators, and require personnel to be available at all times while the system is running to confirm the conditions and to approve the message to be delivered to the travelers. Whichever option an agency chooses, the information delivered to travelers must be accurate; otherwise the public will lose confidence in the system.

Controls should be placed on message boards to prevent conflicting messages from being displayed along the same approach to the work zone area, to prevent messages from changing too often, and to prevent display of unhelpful information (e.g., work zone speed is 85 miles per hour). In addition, personnel from the implementing agency should have real-time access to archived system data in order to identify any issues and monitor system functionality. A website could easily provide password protected access to the data being used by the system to make decisions.

One of the most valuable products of ITS work zone applications is the development of real-time information that can be disseminated to a wide variety of users. ITS work zone systems collect data from several different types of roadside systems, process the data, and – with minimal human interaction – translate those data into valuable information for facility operators, emergency responders, and the traveling public. Provision of information can be a key in developing and maintaining stakeholder relationships, especially those involving agencies in other jurisdictions. Users of the information provided by the system may include state DOTs, the public and road users, nearby businesses and employers, media outlets, contractors, trucking companies, fleet operators, emergency services providers, motorist assistance patrols, neighboring jurisdictions, and third party traveler information providers.

A common method of information dissemination is through websites operated by state DOTs and other agencies. These websites also frequently include closed circuit television (CCTV) imagery from the ITS, which tend to be popular with travelers. Dissemination of this high





**Tip: It is important to ensure that information delivered to the public is as accurate as possible.**

If inaccurate information is provided, the public can quickly lose confidence, resulting in negative public relations.

quality information not only contributes to the operation of the system, but also builds credibility for the operating agency with the traveling public.

Finally, it is important that data be archived or reported in a way that will be accessible and useful for evaluation of effectiveness. Data are required for project performance monitoring in real time, for post-project assessments of impacts that could be fed back to project designers to aid future project designs, and for agency process reviews, and assessment of work zone policies and procedures as required in federal regulations.

For example, many agencies specify maximum delay or queue length/duration thresholds that will be tolerated as part of their overall bid documents for a project. However, very few employ any type of actual monitoring efforts to aid field inspectors in determining if such threshold are being exceeded (and thus a need to shut down the activity causing the impacts), or to implement any type of penalties or damages for violating the thresholds. Archived work zone ITS data can provide an accurate, objective measure for such efforts.

As another example, work zone ITS data can be used during the project to help accelerate project activities and result in a quicker overall project with reduced impacts to the public. Many agencies have established hours that lane closures are restricted from occurring on high-volume roadways due to concerns over excessive delays and queues. However, oftentimes these restrictions are not tailored to the travel patterns that exist at a given project, but are agency-wide restrictions. During one recent arterial reconstruction project in Salt Lake City, work zone ITS was used to by the contractor to justify requests to Utah DOT to increase the allowable lane closure hours, still avoiding peak travel times and directions, that allowed the project to be completed faster than expected and not result in significant queues or delays for the traveling public.

As part of post-project assessments and overall process reviews, having more data available allows for a more thorough analysis and better conclusions. Work zone ITS, depending on the technology deployed, can assist an agency in assessing the frequency, duration, and

magnitude of impacts that actually occurred. These can then be provided back to the work zone designers to compare against the results of their analyses. If their initial analyses were incorrect, it is often possible to determine the reasons for the incorrect outputs (i.e., error in estimating work zone capacity, diversion rates, etc.). This is an approach that the Michigan DOT has used regularly for its major work zones across the state. Consolidated across several projects, these work zone ITS data can also aid an agency in conducting its required bi-annual work process review. Basic performance measures can be determined for each project, such as<sup>45</sup>:

- Maximum person throughput during peak hour;
- Average per-vehicle delay during lane closure hours;
- Percent of time when delays exceed the established maximum threshold;
- Percent of travelers experiencing a traffic queue; and
- Change in peak-period buffer time through a project.

Once project-specific measures are obtained and examined, it is also possible to aggregate across projects to develop an agency-wide perspective of performance. Examples of process-level measures for an agency could include:

- Percent of projects where delays exceeded the maximum threshold;
- Percent of projects experiencing increases in peak-period buffer indices by more than xx percent; and
- Percent of projects experiencing traffic queues greater than some maximum threshold for some maximum duration.



**Tip: Carefully consider how to set up automated information delivery and sharing with other agencies.**

Particularly with an automated information delivery system, it is possible to deliver too much information for the agency and its partner agencies to process effectively. The frequency, usefulness, and volume of information delivered to managers and partners needs to be appropriate or it will likely be discarded or ignored. Many ITS applications can be set to automatically deliver texts or e-mails to the agency or partners such as the media and public safety agencies. If the thresholds for delivery of these messages are not carefully considered, a recipient may be inundated with information and unable to sort out what is useful.

<sup>45</sup>Ullman, G.L. et al. Guidance on Data Needs, Availability, and Opportunities for Work Zone Performance Measurement. Report FHWA-HOP-13-011. FHWA, U.S. Department of Transportation, Washington, DC, March 2013.



### 6.3 Maintaining adequate staffing

If operations and maintenance are contracted out, it is the contractor's responsibility to ensure that adequate, trained staff is available. However, if in-house staff are engaged, the agency must take steps to ensure that it has multiple staff members trained in system operations, maintenance, and troubleshooting. If these steps are not taken, the retirement or vacation of a key person may cripple the operation of the system or result in additional costs. It is in the agency's best interest to select a set of project personnel who are expected to be available for the duration of the project.

### 6.4 Leveraging public support

A common thread that runs through comments made by agency personnel responsible for implementing ITS in work zones is the need to engage the public during the earliest stages of the project. Publicizing the advanced features of the work zone system and the type of information that will be available to the public is the first stage in developing public support for these systems. In this early stage, while it is important to share potential system benefits with the public, it is likewise important to temper expectations of the system, in case any of the benefits do not ultimately develop. Support from the public and elected officials combined with quantified benefits will help to ensure long-term funding availability for appropriate applications of ITS in future work zones.

### 6.5 Conducting system monitoring and evaluation

It is important to monitor the work zone ITS during its operation to ensure that it is working correctly and meeting the needs of its users, and that the vendor is meeting contract obligations. The data collected and analyzed over the course of the project can then be used as part of a more comprehensive evaluation at the conclusion of the project. In some instances, it may be necessary to modify the deployment to improve operations based on the results from system monitoring.

#### 6.5.1 System monitoring

System monitoring and evaluation will be conducted based on the evaluation plan from Step 3. Data should be collected throughout the course of the ITS deployment according to the plan. Various data elements can be analyzed periodically throughout the course of the project to assess the system performance. It is expected that some data elements will be monitored and analyzed more frequently than others, e.g., on a daily, weekly, monthly, quarterly basis. Data should be used to determine whether system modifications are needed, and also assess the impacts of work zone operations on safety and mobility in the work zone.

Data alone will not be able to address all aspects of the ITS deployment that need to be monitored. Agency staff also need to make observations in the field, which can be logged as qualitative data. Together, the quantitative data and qualitative observations will help ensure that the system is working correctly or identify any changes that may need to be made. For example, system monitoring may show that it takes a long time to recover from the queues that develop before the system puts diversion messages on the PCMS. This may lead to changing the threshold for when diversion messages are displayed (e.g., from 3 mile queues to 2-mile queues). Depending on the location, scale, and duration of the project, it may be desirable to have cameras in the field for staff to monitor traffic conditions from an off-site location to validate sensor data and system-generated PCMS messages with observations. If issues are identified, they should be addressed immediately with the appropriate staff, i.e., contractor, vendor, or agency. It is important for the agency to then ensure that adjustments have corrected the problem and are made in a timely manner.



#### Tip: Questions to consider as you monitor the system during deployment.

- Is the system working correctly? Are messages accurate based on conditions?
- Is the vendor meeting the contract? Are issues being addressed promptly?
- What are the data saying about work zone operations and safety and mobility in the work zone?
- Does the system need to be adjusted (e.g., adjust thresholds, change the wording or timing of PCMS messages, reposition sensors, add sensors)?

System monitoring must be in line with the expectations of all groups that require feedback regarding the work zone ITS deployment. While system monitoring occurs for the entirety of the deployment, the detail of any ongoing monitoring and evaluation reports will likely vary at different intervals throughout the course of the project. Some DOTs maintain dashboards with various performance measures, which may require certain inputs from the deployment on a monthly basis, for example. Agency managers may request updates on a weekly basis, with more detailed reports on a quarterly basis. System monitoring must be scheduled in a way that meets these expectations.

Many work zones consist of multiple phases and many different tasks, which may or may not impact travelers. An evaluation of a work zone ITS deployment should be designed to evaluate effectiveness during those times and locations where impacts were expected to be most

significant. The average delay per vehicle computed over an entire project may be very small, for example, if most of the work occurs off the roadway and only one or two days of work involves reductions in travel lanes. During those one or two days of lane closures, though, the average delay per vehicle will be much higher, and the effect of the work zone ITS on this delay is what will be of most interest to the agency. In other words, a work zone ITS evaluation must be carefully coordinated with field personnel to ensure that the evaluation is both appropriate and meaningful.

The work zone ITS evaluation should be done within the context of the TMP implementation, monitoring, and evaluation of the project. Data collected by the work zone ITS and the evaluation of the work zone ITS deployment may also inform an evaluation of other TMP strategies being used.

### 6.5.2 System modification

System monitoring may identify areas where modifications might be made to improve the performance of the work zone ITS. Discussions with stakeholders can also help to identify adjustments that are needed to system operation or information delivery mechanisms, content, and timing. For example, it may become apparent that additional sensor coverage is needed in a certain location because feedback from customers indicates that travel times being posted to PCMS are not as accurate as expected. In other instances, equipment (e.g., CMS) might be more effective if repositioned or by changing CMS messages for better user understanding.

Modification of a work zone ITS application will depend on both the scope of the system and the duration of the work zone. Adjustments to the deployment can sometimes be made without significant change orders



#### Example: Making modifications to work zone ITS deployments – Illinois.

Agency and contractor staff should monitor work zone conditions, whether formally or informally, to identify ways to improve the system. A traffic management system was procured as part of the overall bid by the contractor for a work zone project on the I-70/I-57 interchange in Effingham, Illinois. Several PCMS were deployed as per the bid specification. Initially, PCMS displayed messages as called out in the contract, as shown on the left in Figure 22. However, as both Illinois DOT and the contractor gained experience with the system and with how motorists responded to the various messages presented, changes to some PCMS messages were made, deviating from the contract. This included the display of specific speeds downstream as shown on the right in Figure 22. For example, the presentation of a given speed (as opposed to a generic “REDUCE SPEED AHEAD” message) was felt to elicit greater compliance by approaching motorists.

Other modifications may require additional funding. On a different project on the I-57/I-64 interchange in Mount Vernon, Illinois, queues occurred that were longer than originally expected. A change order was executed to add sensors and PCMS to the work zone traffic monitoring system that had already been deployed.

or other efforts. Many of these adjustments do not require funding, but some may have additional costs that could pose a challenge for funding. Ideally, costly changes will be avoided through good system planning. In some cases, there may simply not be enough time to evaluate the system thoroughly, make changes, and then implement those changes in the midst of an ongoing construction project. However, some informal assessment of the system is always possible in order to verify the system is operating properly.



Source: FHWA

Figure 22. PCMS messages were modified from a generic message (left) as stated in the contract to a more specific message (right).

### 6.5.3 Final evaluation

At the conclusion of the system deployment, a final evaluation should be conducted. A major objective of the final evaluation is to document lessons learned and benefits of the ITS deployment. This might include the collection of some final qualitative data from stakeholders, e.g., surveys or interviews. Analysis of all collected quantitative and qualitative data that has been collected over the course of the project should be conducted as described by the evaluation plan developed in substep 3.8. Examples of the results of two such evaluations are presented below.

The results, conclusions, and recommendations of the evaluation should be documented in a final report. These results can be used not only by the project partners for continual refinement of similar systems at other locations, but also by others wanting to implement similar systems in the future. The report might also be utilized to justify investments in work zone ITS deployments. ITS evaluation final reports can be entered in the ITS Benefits and Unit Cost Database,<sup>46</sup> so that the evaluation results can be shared with other interested transportation professionals.

#### Key Takeaways

- In this step, the work zone ITS becomes operational in the field with appropriate staff operating and monitoring the deployment, as necessary.
- Flexibility is important. Agency or contractor staff need to be available to make adjustments, as necessary, due to changing work zone conditions and findings from ongoing system monitoring and evaluation.
- A final evaluation should be conducted to include findings from any available data and detail the benefits and lessons learned from the system.



#### Example: Effectiveness of a work zone ITS deployment – Effingham, Illinois.

A work zone ITS was deployed at the I-70/I-57 interchange in Effingham to mitigate the potential for end-of-queue crashes occurring due to traffic incidents or temporary lane closures within the project limits. An assessment of crashes occurring during the two construction seasons of the deployment suggests that the system was useful and effective. From the first year to the second year of construction, the number of lane closure days increased, as did the amount of traffic exposure through the project. Even so, preliminary analysis by the Illinois DOT found that crashes decreased slightly, including end-of-queue crashes. Specifically, from 2010 (prior to system implementation) and 2011 (after system implementation) saw nearly a 14 percent decrease in queuing crashes, and an 11 percent reduction in injury crashes, despite a 52 percent increase in the number of days when temporary lane closures were implemented in the project. Although it is not certain whether the queuing frequencies and conditions between the two years were similar, the trends were very encouraging.



#### Example: Effectiveness of work zone ITS deployment – Comparative Analysis.

An FHWA study of work zone ITS deployments revealed that 50 percent to 80 percent of surveyed drivers diverted at least sometimes due to messages provided on travel time, delay, or alternate routes. The same study noted 56 percent to 60 percent reductions in queue lengths were possible. Finally, it was found that speed monitoring displays could reduce speeds by 4-6 mph, with one study finding a 20 percent to 40 percent reduction in vehicles traveling at least 10 mph over the speed limit with these devices present. (see [http://www.its.dot.gov/jpodocs/repts\\_te/14320.htm](http://www.its.dot.gov/jpodocs/repts_te/14320.htm)).

<sup>46</sup>The database is available online at: <http://www.benefitcost.its.dot.gov>; the website has instructions on how to contribute.

## Appendix A. National ITS Architecture

National ITS Architecture provides a framework for planning, designing, and integrating ITS. It provides important standards for hardware components and software that will allow for integration with other systems. The architecture includes:

- Function – what the system will do;
- Location – where the information will reside; and
- Integration – path that allows information to flow among the physical components.

The use of ITS in work zones has grown to the point that steps have been taken toward its inclusion in the *National ITS Program Plan* and the National ITS Architecture 7.0.<sup>47</sup> The work zone related portions of the National Architecture can help to define the functionality of the work zone system and are also useful in developing functional specifications.

The Maintenance And Construction Operations (MCO) User Service Description features work zone management and safety as one of its main functional areas. The MCO User Service underscores the value of work zone information and smart work zones when states and regions establish regional ITS architectures for ITS deployment. MCO User Service functional areas include:

- Maintenance Vehicle Fleet Management: monitors and tracks locations and conditions of fleets of maintenance, construction, and specialized service vehicles
- Roadway Management: monitors and forecasts conditions and manages treatment of roadways during various travel conditions
- Work Zone Management and Safety: supports effective and efficient roadway operations during work zone activities
- Roadway Maintenance Conditions and Work Plan Dissemination: coordinates work plans and communicates conditions

<sup>47</sup>For more information about the National ITS Architecture, see [http://ops.fhwa.dot.gov/its\\_arch\\_imp](http://ops.fhwa.dot.gov/its_arch_imp)

MCO User Service Requirements that pertain to work zone management and safety are:

8.1.3	Maintenance and Construction Operations shall provide a Work Zone Management and Safety (WZMS) function, which provides support for the effectiveness, safety, and efficiency of roadway operations during all work zone activities. This function includes interactions among Traffic Managers, Supervisors, Dispatchers, Field Crews, Construction Crews, Public Safety Organizations, Information Service Providers, and Travelers.	8.1.3.2.1	WZMS shall collect information concerning work zone activities, including but not limited to:
		8.1.3.2.1(a)	Location
		8.1.3.2.1(b)	Nature / type
		8.1.3.2.1(c)	Scheduled start time
		8.1.3.2.1(d)	Duration
		8.1.3.2.1(e)	Lane shifts
		8.1.3.2.1(f)	Staging areas
		8.1.3.2.1(g)	Length of work zone
8.1.3.1	WZMS shall monitor, control, and direct activity in the vicinity of work zones.	8.1.3.2.1(h)	Scheduled phases of work zone configuration
		8.1.3.2.1(i)	Alternate routes
8.1.3.1.1	WZMS shall provide information about work zones, including but not limited to:	8.1.3.2.1(j)	Anticipated delays for travel route
		8.1.3.2.1(k)	Anticipated delays for diversion route
8.1.3.1.1(a)	Anticipated delays	8.1.3.2.2	WZMS shall correlate planned activities with actual work.
8.1.3.1.1(b)	Alternate routes	8.1.3.2.3	WZMS shall support preparation of reports on work zone activities.
8.1.3.1.1(c)	Suggested speed limit	8.1.3.2.4	WZMS shall provide information on work zone activities to other agencies, including but not limited to:
8.1.3.1.2	WZMS shall provide support for automated speed enforcement around work zones.	8.1.3.2.4(a)	Other maintenance and construction operations systems
8.1.3.1.3	WZMS shall be able to divert vehicles around work zones via automated lane changing techniques.	8.1.3.2.4(b)	Commercial vehicle fleets
		8.1.3.2.4(c)	Emergency vehicle fleets
8.1.3.1.3.1	WZMS shall collect information used to support automated lane changing, including but not limited to:	8.1.3.2.4(d)	Traveler information systems
		8.1.3.2.4(e)	Traffic management systems
8.1.3.1.3.1(a)	Volume	8.1.3.3	WZMS shall provide systems that communicate reliable, accurate, and timely traveler information, including but not limited to:
8.1.3.1.3.1(b)	Occupancy		
8.1.3.1.3.1(c)	Speed	8.1.3.3(a)	Location, including lane closure information
8.1.3.1.3.1(d)	Headways	8.1.3.3(b)	Alternate route / detour
8.1.3.1.3.1(e)	Vehicle characteristics	8.1.3.3(c)	Work zone speed limit
8.1.3.1.3.1(f)	Merging distance	8.1.3.3(d)	Delay
8.1.3.1.3.2	WZMS shall support archiving of field data.	8.1.3.4	WZMS shall support the provision of vehicle intrusion warnings.
8.1.3.1.3.3	WZMS shall support use of field data for developing AHS-merging strategies.	8.1.3.5	WZMS shall be capable of tracking individual crew movements.
8.1.3.2	WZMS shall support the management of data about work zones.		



## Appendix B. Summary of Resources Reported in this Document

### Primary resources

- FHWA Work Zone Mobility and Safety Program – numerous resources to help transportation professionals familiarize themselves with work zone planning, analysis, and traffic management and with the current state of the practice on ITS in work zones (<http://www.ops.fhwa.dot.gov/wz>).
- American Traffic Safety Services Association (ATSSA) ITS Council. “ITS Safety and Mobility Solutions: Improving Travel Through America’s Work Zones.” This describes various ITS applications for work zones and potential benefits, considerations for use, and system layouts ([http://www.atssa.com/galleries/default-file/2008July21\\_ITS\\_Safety\\_and\\_Mobility.pdf](http://www.atssa.com/galleries/default-file/2008July21_ITS_Safety_and_Mobility.pdf)).
- American Association of State and Highway Transportation Officials (AASHTO) – a work zone ITS site as part of its System Operations and Management Subcommittee, including evaluation reports, sample specifications/standards, and drawings (<http://ssom.transportation.org/Pages/ITSinWorkZones.aspx>).

### Published documents and resources to support ITS strategic planning

- “Best Practices of Rural and Statewide ITS Strategic Planning” ([http://ntl.bts.gov/lib/jpodocs/repts\\_te/13608.pdf](http://ntl.bts.gov/lib/jpodocs/repts_te/13608.pdf)).
- “Regional ITS Architecture Guidance” by the National Architecture Team (<http://www.ops.fhwa.dot.gov/publications/regitsarchguide/raguide.pdf>).
- The ITS Architecture Implementation Program ([http://ops.fhwa.dot.gov/its\\_arch\\_imp](http://ops.fhwa.dot.gov/its_arch_imp)).
- Research and Innovative Technology Administration (RITA) ITS JPO (<http://www.its.dot.gov>).
- FHWA guide “Work Zone Public Information and Outreach Strategies” – designed to help agencies plan implement effective public information and outreach campaigns to mitigate the negative effects of work zones ([http://www.ops.fhwa.dot.gov/wz/info\\_and\\_outreach/public\\_outreach\\_guide.pdf](http://www.ops.fhwa.dot.gov/wz/info_and_outreach/public_outreach_guide.pdf)).
- The FHWA Peer-to-Peer Program for Work Zones – contains materials from a Work Zone ITS Peer Exchange Workshop conducted in May 2013 (<http://www.ops.fhwa.dot.gov/wz/p2p/>).

### Helpful publications for work zone ITS solutions

- “Advancing Metropolitan Planning for Operations: The Building Blocks of a Model Transportation Plan Incorporating Operations – A Desk Reference” (<http://www.ops.fhwa.dot.gov/publications/fhwahop10027>).
- “Designing for Transportation Management and Operations: A Primer” (<http://www.ops.fhwa.dot.gov/publications/fhwahop13013/index.htm>).
- The FHWA ATDM program presents numerous strategies that may be effectively utilized in work zones (<http://www.ops.fhwa.dot.gov/publications/fhwahop12032>).
- The Caltrans “Systems Engineering Guidebook For ITS” ([http://www.dot.ca.gov/newtech/docs/se\\_guidebook\\_ver1-12\\_14\\_05.pdf](http://www.dot.ca.gov/newtech/docs/se_guidebook_ver1-12_14_05.pdf)).

### Guidance for the use of work zone safety and mobility performance measures

- “A Primer on Work Zone Safety and Mobility Performance Measurement” offers information for understanding data requirements for generating useful performance measures (<http://ops.fhwa.dot.gov/wz/resources/publications/fhwahop11033/fhwahop11033.pdf>).
- “Work Zone Performance Measures Pilot Test” summarizes lessons learned through the identification and testing of a candidate set of work zone mobility-related performance measures at five projects nationwide (<http://www.ops.fhwa.dot.gov/wz/resources/publications/fhwahop11022>).
- “Guidance on Data Needs, Availability, and Opportunities for Work Zone Performance Measures” provides more in-depth information and guidance on the usefulness of various measures, and the data necessary to develop and use them effectively ([http://www.ops.fhwa.dot.gov/wz/decision\\_support/performance-development.htm](http://www.ops.fhwa.dot.gov/wz/decision_support/performance-development.htm)).



### **Use of private sector data for work zone performance measurement**

- Middleton, D. et al. Synthesis of TxDOT Uses of Real-Time Commercial Traffic Data. Report No. FHWA/TX-12/0-6659-1. Texas Transportation Institute, College Station, TX. January 2012.
- Edwards, M.B. and M.D. Fontaine. Investigation of Travel Time Reliability in Work Zones with Private-Sector Data. In Transportation Research Record: Journal of the Transportation Research Board No. 2272. TRB of the National Academies, Washington, DC. 2012. pp. 9-18.
- Turner, S. et al. Private Sector Data for Performance Measurement – Final Report. Report No. FHWA-HOP-11-029. FHWA, U.S. Department of Transportation, Washington, DC. July 2011.

### **Professional development in work zone ITS**

- The National Highway Institute (NHI) offers courses addressing a wide variety of aspects of ITS, including systems engineering, project management, telecommunications, software acquisition, and ITS procurement (<http://www.pcb.its.dot.gov>).
- Web-based courses are available through the Consortium for ITS Training and Education (CITE, <http://www.citeconsortium.org>).
- LTAP resources are also available for work zones and ITS (<http://www.ltap.org/resources/searchdbs.php>).

### **Helpful resources for evaluating and comparing options for ITS deployment**

- Benefit/cost analysis is one useful tool in evaluating and comparing multiple options for ITS deployment, including the option not to deploy ITS in the work zone at all. The ITS Benefits and Costs Database ([www.benefitcost.its.dot.gov](http://www.benefitcost.its.dot.gov)) can be a useful resource. The database includes unit cost data for many of the ITS items related to work zones.
- The ITS Deployment Analysis System (IDAS) is a software tool that estimates the costs and benefits of ITS investments (<http://idas.camsys.com>).
- QuickZone is a spreadsheet developed by the FHWA, which provides a general and quick work zone traffic impact analysis capability (Information at: <http://www.fhwa.dot.gov/research/topics/operations/travelanalysis/quickzone/>).
- The FHWA Traffic Analysis Toolbox includes guides for work zone modeling and simulation (<http://ops.fhwa.dot.gov/trafficanalysistools>).
- Criteria for Portable ATIS [Advanced Traveler Information Systems] in Work Zones: Lane Merge, Travel Time and Speed Advisory Systems, Horowitz, 2005 (<http://www.ctre.iastate.edu/smartwz/details.cfm?projectid=10>).
- Operational and Safety Benefits of Using ITS in Work Zones, Fontaine, 2005 (<http://ssom.transportation.org/Pages/Sept2005Workshop.aspx>).
- The USDOT ITS Joint Program Office (USDOT ITS JPO) has developed the ITS Evaluation Resource Guide to assist agencies in conducting evaluations of ITS projects ([http://www.its.dot.gov/eval/eguide\\_resguide.htm](http://www.its.dot.gov/eval/eguide_resguide.htm)).
- The work zone performance measures primer is a useful source of information for understanding data requirements for generating useful performance measures (<http://ops.fhwa.dot.gov/wz/resources/publications/fhwahop11033/fhwahop11033.pdf>).
- The “Operations Benefit/Cost Analysis Desk Reference” might also serve as useful guidance for benefit-cost analyses (<http://www.ops.fhwa.dot.gov/publications/fhwahop12028>).

## Appendix C. Issues for Consideration

Below is a list of key points and tips that have been presented throughout this work zone ITS implementation guide.

### Step 1 – Assessment of Needs

- **Key Point: *Work zone ITS is one of several tools available to address specific safety and mobility issues in work zones.*** If goals and objectives become more manageable to achieve through a different technique, that technique should be selected instead of ITS. Other strategies may be more economical and effective in meeting goals and objectives.
- **Tip: *Have realistic expectations.*** Although some ITS applications may be promoted as a catch-all solution to safety and capacity problems, field testing has not always shown conclusive benefits. Work zone ITS should be well designed and smartly applied to scenarios in which benefits are most likely to be achieved.
- **Tip: *Be sure that the work zone ITS fully captures the range of impacts for which it is intended.*** This is particularly important for deployments that are intended to convey delay or queue length information to users. In some deployments, work zone impacts periodically extended beyond the limits of the ITS devices. When this happened, the system was unable to provide accurate information. More importantly, the motorists sat through several minutes of delay before encountering a message that there were delays and reduced speeds in the work zone. This severely limited the credibility, usefulness, and benefits of the system.
- **Tip: *Stakeholder agencies, besides the deploying agency, need to be involved early.*** Coordination with other agencies is a primary issue that should be considered both in developing and implementing an ITS work zone. This will be important for determining how the system can work within each agency's existing procedures.

### Step 2 – Concept Development and Feasibility

- **Key point: *Not all ITS deployments are complicated and expensive.*** For example, an additional temporary traffic sensor or two may be all that is needed to expand or enhance an existing permanent ITS deployment to be an effective tool for managing traffic impacts at a particular work zone. This was the approach taken during the I-15 CORE project in central Utah.
- **Tip: *Systems need to have reliable communications.*** The communications network for an ITS application is vital to the operation of the system and must be reliable. Issues that may impact communications need to be addressed early in the system development and deployment process. What may seem like a trivial issue at the outset may evolve into a more difficult problem when deploying or operating the system. Such issues include whether adequate cellular capacity is available and whether there are obstructions to signal transmission due to geography or terrain.
- **Key point: *Whether to use ITS to address a work zone need has to be assessed because work zone ITS may not be the only or best way to address a particular issue.*** For example, project staff at case study sites in Effingham and Mount Vernon, IL considered whether to use ITS the need for queue warning. Because on the need for automatic queue warning and delay information dissemination, staff at both projects considered alternatives and decided early on that some type of work zone ITS would be deployed. There had been previous efforts by Illinois DOT to warn drivers approaching a work zone with queues through the use of either enforcement personnel positioned upstream of the work, or through the use of Illinois DOT staff with truck-mounted CMS. The difficulties of predicting when queues would occur, having sufficient staff available to schedule during those times, and keeping the warning device (enforcement vehicle or the truck-mounted CMS) in the proper location relative to the end of the queue reduced the practicality of these approaches. Illinois DOT staff were also concerned with the potential liability associated with sometimes, but not always, being able to have an enforcement vehicle or truck-mounted CMS present when queues were expected.

### Step 3 – Detailed System Planning and Design

- **Tip: *It is important to use a proactive approach in building public awareness of the project and the information that the ITS application will provide.*** Successful techniques include holding press conferences, issuing news releases, and keeping local media (especially those the public turns to for traffic information) up to date.

**• Tip: Helpful hints for planning an evaluation.**

- Evaluations can be either qualitative or quantitative; however, the best evaluations employ a combination of both types of information.
- The most effective evaluations occur when the goals and objectives for a work zone ITS are explicitly stated, measurable, and agreed to by all stakeholders.
- Examining the role of research in the evaluation step of the project will help clarify the types of analyses that can be performed to produce benefits data.
- It is helpful to provide a mechanism for the public to offer feedback on the project. Several agencies have used comment sections on the project websites to collect this feedback.
- The formality and magnitude of an evaluation should match the level of the ITS deployment. An informal evaluation may be sufficient for simple systems, while a more formal evaluation would be better suited for a larger-scale deployment.

**Step 4 – Procurement**

**• Key Point: Procurement of ITS need not conform to a traditional approach.** The Minnesota DOT issued a stand-alone, design-bid-build, best-value contract to facilitate work zone ITS for a set of three simultaneous construction projects with separate contractors on a single stretch of highway. This mechanism helped assure contractor qualifications and expertise for designing, deploying, and operating a single, quality ITS, along with performance-based considerations for the projects. The Minnesota DOT has also discussed issuing a general contract to have an ITS contractor on call. The ITS contractor would engage stakeholders and provide input and recommendations for work zone ITS early on for selected projects the agency believes will require it, stay abreast of rapidly changing technologies, and help the agency use ITS to its maximum potential.

**• Tip: Strategies for Successful Procurement.**

- Agencies need to consider the necessary personnel experience for operating and maintaining work zone ITS before deciding whether to purchase or lease work zone ITS, so that the procured system can be effectively operated and maintained.
- Regardless of whether ITS is procured directly by an agency or indirectly through a construction contract, it is important that there be expertise available locally (either on agency, contractor, or vendor staff) who are tasked with day-to-day responsibility for operations and maintenance of the system to enable quick response and resolution of issues.
- Typically, for indirect procurements it is better to include work zone ITS as part of the construction contract than as an addition through a change order to minimize costs and reduce frustration. In addition, change orders over a given amount or percent on a project may require high-level administrative approval before procurement, which can delay when the system can be obtained and deployed.
- While change orders are not the preferred procurement approach, agencies should also recognize the potential need for change orders to modify or enhance the system once it is implemented and operational experience is gained regarding actual work zone impacts.
- Hybrid approaches that mix two or more of the procurement approaches discussed herein are possible. For example, an agency may choose to purchase a COTS system itself through a low-bid selection process, and then hire a vendor to deploy, calibrate, and operate the system on an as-directed basis through a low-bid or other type of selection process. As another example, an agency could specify that the contractor obtain a COTS system for the purpose of providing queue warning protection upstream of temporary lane closures, considering the payment for the system as a type of mobilization cost. Then, each time the system needs to be deployed, a per-use or per-day fee could be negotiated with the contractor to cover labor costs for deployment, operation, and retrieval.
- In some cases, agencies will specify that project funding will be withheld if ITS components are not maintained in a satisfactory operating condition as one way of increasing its importance with the contractor.
- It is important to remember that 3rd party traffic data collected primarily by vehicle probes can provide good work zone travel time and delay information, but will be less sensitive to the onset of queues that form until the queues reach a substantial length. Only those vendors that can provide spot speed data will be effective for supporting queue detection and warning systems.

## Step 5 – System Deployment

- **Tip: Allow start-up time when deploying a system.** Problems will arise—such as the operation of sensors, communications (wireless or wired), calibration, or software—and will take time to address. These “bugs” require time to locate and address. Failure to allow for sufficient start-up time can lead to less than optimal performance of the system during the initial days of the project. Unfortunately, this is often the time at which the system is most needed, as drivers are encountering unexpected conditions due to the capacity and operational constraints imposed by the MOT plan, are surprised, and need and would benefit significantly from having improved information and guidance in how to best accommodate the work zone.
- **Tip: Quickly deploying work zone ITS is possible but can require extra resources.** Although it is desirable to begin the process for considering, planning, designing, and deploying a work zone ITS early in the overall project development process, circumstances sometimes dictate that an accelerated timeline be followed. It is important to recognize when such circumstances arise and to dedicate enough resources to be successful in meeting that timeline. For example, a work zone ITS deployment used on the Big I (I-40) project in Albuquerque, New Mexico, was able to go from concept to full operation in only 15 weeks. However, to accomplish this, the agency had to employ several experienced ITS contractors for the ITS design, system selection, and system installation.

## Step 6 – Operation, Maintenance, and Evaluation

- **Key Point: Sometimes conditions in the field may differ from what was expected during systems planning and design, and adjustments may be needed.** For example, queues may be longer or shorter than what was estimated before construction actually started. Personnel should monitor conditions in the field such that if queues regularly extend beyond the system signs (or detectors), the agency/contractor can consider adjusting the placement of the system components to make the most effective use of the system or adding additional devices to extend coverage.
- **Tip: Manage expectations.** It is important to assess and update expectations based on true experiences of the deployment in the work zone. The deployment may have greater or lesser impacts than originally anticipated, and it is important for stakeholders to understand why that is the case.
- **Tip: It is important to ensure that information delivered to the public is as accurate as possible.** If inaccurate information is provided, the public can quickly lose confidence, resulting in negative public relations.
- **Tip: Carefully consider how to set up automated information delivery and sharing with other agencies.** Particularly with an automated information delivery system, it is possible to deliver too much information for the agency and its partner agencies to process effectively. The frequency, usefulness, and volume of information delivered to managers and partners needs to be appropriate or it will likely be discarded or ignored. Many ITS applications can be set to automatically deliver texts or e-mails to the agency or partners such as the media and public safety agencies. If the thresholds for delivery of these messages are not carefully considered, a recipient may be inundated with information and unable to sort out what is useful.
- **Tip: Questions to consider as you monitor the system during deployment.**
  - Is the system working correctly? Are messages accurate based on conditions?
  - Is the vendor meeting the contract? Are issues being addressed promptly?
  - What are the data saying about work zone operations and safety and mobility in the work zone?
  - Does the system need to be adjusted (e.g., adjust thresholds, change the wording or timing of PCMS messages, reposition sensors, add sensors)?

## Appendix D. Acknowledgements

The authors of this report are grateful for the assistance and feedback provided throughout this project by the FHWA work zone team. Tracy Scriba was FHWA's Task Manager for the project and directly provided invaluable support and guidance throughout the effort. Numerous representatives of the State Departments of Transportation and vendors also provided support in the development of the guidance contained herein. We are most grateful for the assistance of all the individuals who provided suggestions and feedback, and have tried to incorporate all of the helpful input to improve this guide.



U.S. Department of Transportation  
**Federal Highway Administration**

U.S. Department of Transportation  
Federal Highway Administration  
Office of Operations  
1200 New Jersey Ave., SE  
Washington, D.C. 20590

[www.fhwa.dot.gov/workzones](http://www.fhwa.dot.gov/workzones)

FHWA-HOP-14-008



Screen capture of FHWA Work Zone ITS Implementation Tool V1.0 dated December 29, 2018.  
Source: <https://www.itsforge.net/index.php/community/explore-applications#/40/150>

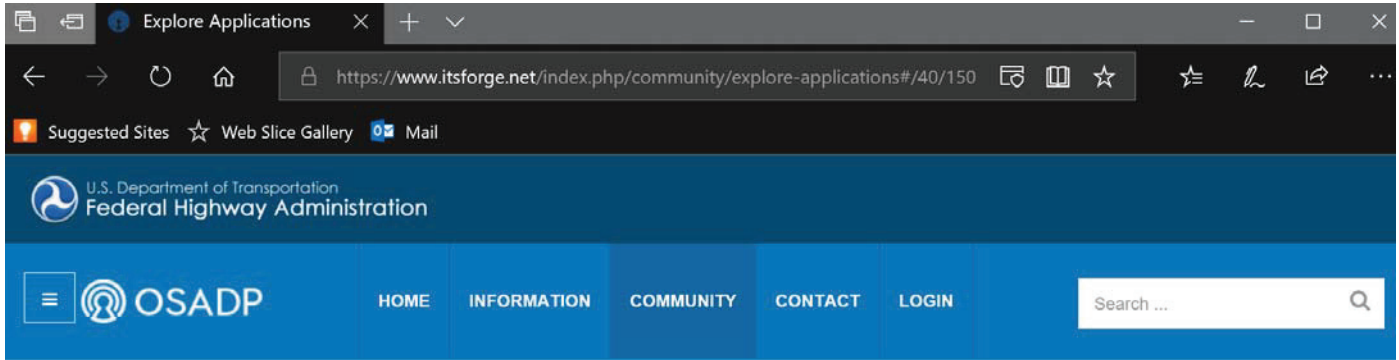

**Explore Applications**

**Work Zone ITS Implementation Tool v1.0** LOGIN TO DOWNLOAD

Published: 2018-03-07 00:00:00

Downloads: 105

**STABLE**   

Categories: [Roadway Operations & Maintenance](#), [Information Management](#)

- Overview
- Description
- Release Notes
- Documentation
- Discussion
- Similar Applications

Intelligent Transportation System (ITS) technology enables solutions that serve broader Transportation System Management and Operations (TSMO) objectives. Specifically, ITS deployments can be part of an effective TSMO strategy for highway work zones. The Work Zone ITS Implementation Guide (FHWA-HOP-14-008), presents a systems engineering framework for assessing the suitability of ITS as part of an agency's work zone management program. The **Work Zone ITS Implementation Tool** serves as a software companion to the Guide, with features that enhance the data collection and quantitative assessments necessary to determine the suitability of ITS solutions. This software is intended for use by agencies in support of independent decision-making regarding selection, design, procurement, deployment and evaluation of ITS systems for construction and maintenance projects.

# Appendix B

## State Departments of Transportation – SWZ Guidelines

**Connecticut Department of Transportation**

Smart Work Zone Guide – April 2017

[http://www.ct.gov/dot/lib/dot/documents/dconstruction/wzs\\_reviews/STR\\_SWZ\\_Guide\\_FINAL\\_2017-04-06\\_with\\_Cover.pdf](http://www.ct.gov/dot/lib/dot/documents/dconstruction/wzs_reviews/STR_SWZ_Guide_FINAL_2017-04-06_with_Cover.pdf)

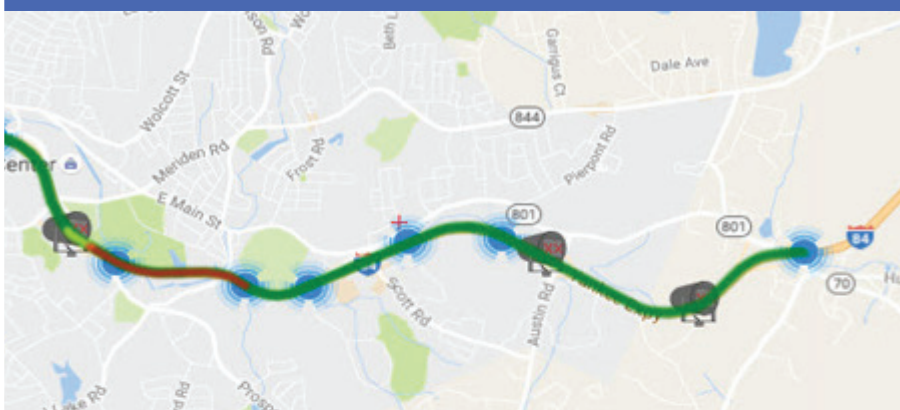

	<p>CCTV6 I-84 (W of Exit 25/Austin Rd) EB traffic is closest to camera</p>					
	<p>I-84 EB PCMS Exit 23 (P-66)</p>	<p>EXIT 25A 3 MILES 5 MIN</p>				
	<p>I-84 Sensor 01 (at Exit 23 E Off Ramp/Hamilton Ave)</p>	<table border="1"> <tr> <td>EB</td> <td>WB</td> </tr> <tr> <td>57 mph</td> <td>50 mph</td> </tr> </table>	EB	WB	57 mph	50 mph
EB	WB					
57 mph	50 mph					



April 2017

# Connecticut Department of Transportation Smart Work Zones Guide

<b>CLIENT:</b>	Connecticut Department of Transportation
<b>PROJECT NAME:</b>	Connecticut Bridgeport Operations Center
<b>REPORT TITLE:</b>	Smart Work Zones Guide
<b>IBI REFERENCE:</b>	BO-33630
<b>VERSION:</b>	Final Version
<b>DIGITAL MASTER:</b>	J:\33630_Bridgeport2013-2017CT\5.0 Design (Work) Phase\Smart Work Zone\Final Guide\STR_SWZ_Guide_FINAL_2017-04-06.docx
<b>ORIGINATOR:</b>	Padma Venugopal, Hasti Tajtehranifard, Tina Le
<b>REVIEWER:</b>	James Sorensen
<b>IMAGE REFERENCE</b>	Images used in the cover sheet provided by CTDOT

Smart Work Zones (SWZ) are applications of Intelligent Transportation Systems (ITS) in work zones, utilized to help increase safety and mobility.

Smart work zones guide presents the basic guidelines for the consistent and uniform usage of SWZ in the State of Connecticut. Project designers remain responsible for customizing and adapting this guidance to meet specific project needs, conditions, and context. All Smart Work Zones in the State of Connecticut shall conform to standards and guidance provided in Part 6: Temporary Traffic Control of the Manual on Uniform Traffic Control Devices (MUTCD), as well as any standards and practices set by the Connecticut Department of Transportation (CTDOT).

Through appropriate use of SWZ, CTDOT aims to improve safety for roadway users and work zone personnel, increase mobility in work zones, and reduce work zone traffic incidents.

This guide provides an introduction to SWZ concepts, components, goals, and objectives to be pursued by CTDOT, as well as an overview of different SWZ applications to be used by CTDOT. These applications currently include, but are not limited to, real-time traveler information notifications, performance measurements, queue warning, intrusion detection, excessive speed warning, entering/exiting vehicle notifications, and over height vehicle notifications.

This guide also outlines the roles and responsibilities of different entities involved in the process of SWZ implementation. Such entities include CTDOT's SWZ Feasibility Determination Committee, Highway Operations, Office of Construction, Division of Traffic Engineering, District Offices, Office of Planning, the Project Designer, and the Contractor.

Guidelines for SWZ project-level feasibility determination and proper implementation are also explained in this guide.

The presented guidelines are designed to facilitate successful application of SWZ and bring about a variety of benefits including, but not limited to, increased safety to work zone personnel, emergency responders and general traffic, reduced delay, queue length, congestion and probability of secondary crashes, improved work zone travel time, travel speed and traveller information, and decreased incident clearance time.



<b>1</b>	<b>Purpose of Guide</b> .....	<b>1</b>
<b>2</b>	<b>Introduction to SWZ Technologies</b> .....	<b>2</b>
2.1	SWZ Overview .....	2
2.2	SWZ Components.....	3
2.3	SWZ Applications.....	3
2.4	Benefits of SWZ .....	4
<b>3</b>	<b>CTDOT SWZ Policies</b> .....	<b>5</b>
3.1	SWZ Goals and Objectives.....	5
3.2	Roles and Responsibilities.....	6
<b>4</b>	<b>Project-Level Feasibility of SWZ</b> .....	<b>8</b>
4.1	Project Criteria .....	8
4.2	Project Characteristics and SWZ Applications .....	10
4.3	SWZ Applications.....	11
4.3.1	Real-Time Traveler Information .....	12
4.3.2	Performance Measurement .....	13
4.3.3	Queue Warning.....	14
4.3.4	Intrusion Detection .....	15
4.3.5	Excessive Speed Warning .....	16
4.3.6	Entering/Exiting Vehicle Notification .....	17
4.3.7	Over Height Vehicle Notification .....	18
4.3.8	Other SWZ Applications.....	19
4.4	Integration of Existing Permanent ITS .....	20
4.5	Typical SWZ Deployment Cost.....	20
<b>5</b>	<b>Guidelines for Implementation of SWZ</b> .....	<b>21</b>
5.1	Design .....	21
5.2	Procurement .....	22
5.3	Deployment.....	22
5.4	Operations and Data Collection.....	23

5.5	Security .....	24
5.6	Maintenance and Evaluation.....	24
5.7	Removal.....	25
	REFERENCES .....	26

### **List of Appendices**

Appendix A –SWZ Implementation Plan	A-1
Appendix B – Data Analysis Examples	B-1
Appendix C – Sample SEAFORM	C-1

# 1 Purpose of Guide

The purpose of the smart work zones guide is to present basic guidelines for the **correct, consistent and uniform usage** of Smart Work Zones (SWZ) in the State of Connecticut.

Smart Work Zones in the State of Connecticut shall conform to the standards and guidelines contained in Part 6: Temporary Traffic Control of the Manual on Uniform Traffic Control Devices (MUTCD)<sup>1</sup> (see also References for this manual), as well as those standards and practices put in place by CTDOT. Project designers remain responsible for customizing and adapting this guidance to specific project needs, conditions, and context.

If there are any questions on this guide, please contact CTDOT Highway Operations ITS Engineering and Support at DOT.ITSEngineering@ct.gov for further clarification.

Acronyms used in this guide are defined in the table below:

ACRONYM	DEFINITION
ADT	Average Daily Traffic
BOC	Bridgeport Operations Center
CCTV	Closed-Circuit Television
CTDOT	Connecticut Department of Transportation
DOT	Department of Transportation
FHWA	Federal Highway Administration
HOC	Highway Operations Center
ITS	Intelligent Transportation Systems
MPT	Maintenance and Protection of Traffic
MUTCD	Manual on Uniform Traffic Control Devices
NOC	Newington Operations Center
PVMS	Portable Variable Message Sign
RWIS	Road Weather Information System
SEAFORM	Systems Engineering Analysis FORM
SWZ	Smart Work Zones
TMP	Traffic Management Plan
TTC	Temporary Traffic Control
USDOT	United States Department of Transportation
VMS	Variable Message Sign

<sup>1</sup> Federal Highways Administration, U.S. Department of Transportation. Manual on Uniform Traffic Control Devices. 2009 Edition with Revisions 1 and 2, May 2012.

## 2 Introduction to SWZ Technologies

### 2.1 SWZ Overview

Smart Work Zones are applications of Intelligent Transportation Systems (ITS) concepts in work zones to increase safety and mobility. SWZ components are also sometimes referred to by other agencies as “Work Zone ITS” or “Portable Work Zone Technology.” SWZ typically collect real-time information at work zones, run a decision logic (standalone in the field or coordinated at a central location), and disseminate actionable information such as delay, travel time, queue warning, intrusion alert, etc. to end-users.

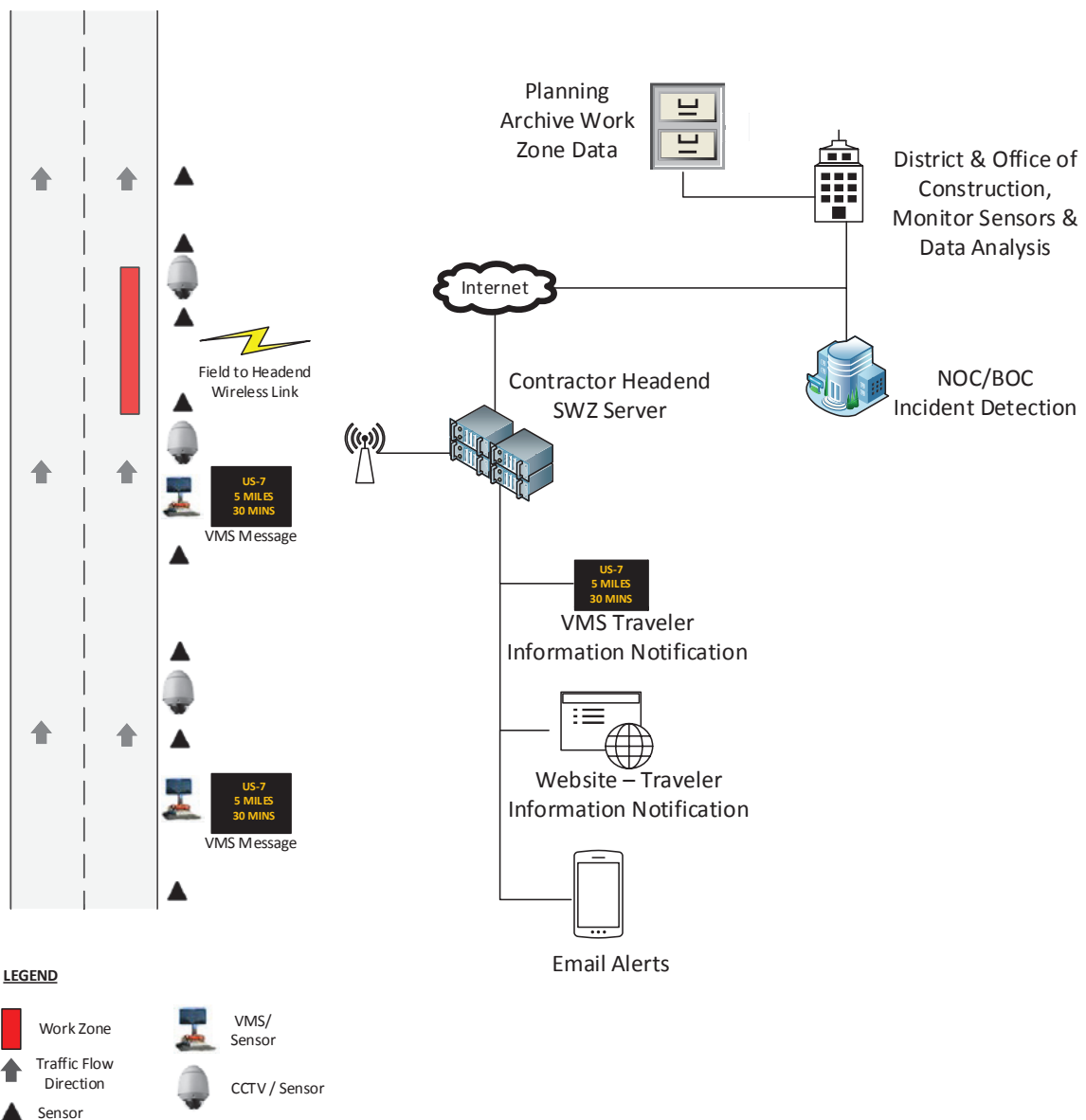

**Example Concept of Operations Block Diagram**

## 2.2 SWZ Components

A typical SWZ consists of field sensors or ITS equipment, communications systems, software application and electronic information distribution components.

COMPONENTS	DESCRIPTION
<b>Sensors and ITS Field Components</b>	<p>Sensors can be deployed along work zones to gather real time data such as traffic volume, speed, occupancy, etc. When additional monitoring of work zone conditions provides valuable information, ITS equipment such as Closed-Circuit Television (CCTV), Road Weather Information System (RWIS), etc. can be deployed. These field devices are typically portable and mounted on a trailer.</p> <p>There is also potential for future use of real-time traffic data collected and disseminated by providers such as Inrix, Here (formerly NAVTEQ Maps), WAZE, TomTom, etc.</p>
<b>Communications Systems</b>	<p>Communications Systems are used to transmit data collected at work zones to a central location for processing and dissemination, and/or communication between SWZ devices in the field. Due to the portable nature of SWZ devices, the typical communications systems used in SWZ deployments are wireless cellular communication.</p>
<b>Software Application</b>	<p>Vendor supplied or custom developed software application processes and analyzes data collected at work zones by applying decision logic based on parameters set. A typical software application allows for:</p> <ul style="list-style-type: none"> <li>• configuration of constraints for various parameters (ex. traffic speed limits)</li> <li>• actions to be taken when the constraints are met (ex. display messages via Portable Variable Message Signs (PVMS)<sup>2</sup> in work zones)</li> <li>• provision of status and location information of field devices in a map view</li> <li>• dissemination of actionable information to end-users via electronic information exchange means (websites, email text alerts, PVMS, etc.) and visible or audible alarms</li> <li>• archiving raw and processed information and retrieval of archived data</li> </ul>
<b>Information Distribution Equipment</b>	<p>The output of decision logic applied in the software application is disseminated to end-users using various information distribution methods such as PVMS, websites, email/text alerts, audible/visual alarms, or other means. Information such as travel time through work zone, delay, queue warning and speed reduction in work zone, incidents and construction vehicle entering and exiting work zone, are often communicated to end-users.</p>

## 2.3 SWZ Applications

Using the SWZ components described in Section 2.2, various work zone ITS applications can be developed to address specific work zone needs. The following table provides a short description of some of the applications which are of interest and applicable to CTDOT.

<sup>2</sup> CTDOT typically uses the terms Variable Message Sign (VMS) and Portable Variable Message Sign (PVMS). The terms Changeable Message Sign (CMS), Portable Changeable Message Sign (PCMS), and Dynamic Message Sign (DMS) are also used in the industry.

APPLICATION	DESCRIPTION
<b>Real-Time Traveler Information</b>	The Real-Time Traveler Information SWZ application provides real-time travel time information through a work zone. A typical system includes sensors in field to collect traffic data, PVMS to display travel time through work zone, communications systems, and software applications to process, analyze, disseminate, and archive data.
<b>Performance Measurement</b>	The Performance Measurement SWZ application is similar to Real-Time Traveler Information, except that the data collected is mainly used for the purpose of performance measurement and enables modifications to operations and support. This system is not designed to provide notifications to the general public.
<b>Queue Warning</b>	The Queue Warning SWZ application provides warning information on slow or stopped traffic ahead in a work zone. A typical system includes field sensors to collect traffic data, PVMS to display delay/stopped traffic in work zone, communications systems, and software applications to process, analyze, disseminate, and archive data.
<b>Incident Management</b>	The Incident Management SWZ application allows for increased visibility, management and quicker response and clearing of traffic incidents. A typical system includes field sensors to collect traffic data, CCTV cameras to provide live feeds, PVMS to communicate incident related delays to end-users, communications systems, and software applications to process, analyze, disseminate, and archive data.
<b>Dynamic Lane Merge (early merge, late merge)</b>	The Dynamic Lane Merge SWZ application provides information to drivers to enable merging earlier or later based on current conditions in the work zone. A typical system includes field sensors to collect traffic data, PVMS to display instructions to merge traffic at specific points in work zone, communications systems, and software applications to process, analyze, disseminate, and archive data.
<b>Excessive Speed Warning</b>	The Excessive Speed Warning SWZ application can be used to provide warning to drivers of vehicles travelling above the speed limit in or prior to approaching a work zone. A typical system includes a radar trailer with a speed display sign to measure and display vehicle speeds and alert drivers to reduce potentially excessive speed.
<b>Entering/Exiting Vehicle Notification</b>	Entering/Exiting Vehicle Notification SWZ application can be used to warn drivers of slow moving construction or emergency vehicles, entering or exiting the roadway. A typical system includes field sensors that activate PVMS to display notification to motorists.
<b>Intrusion Detection</b>	The Intrusion Detection SWZ application can be used to alert work zone personnel when a vehicle enters a work zone. A typical system includes field sensors connected to speakers and/or lights to immediately notify work zone personnel of an intrusion.
<b>Over Height Vehicle</b>	The Over Height Vehicle notification/warning SWZ application can be used to provide warnings to drivers of over height vehicles prior to entering areas with low clearance due to construction activity. A typical system includes field sensors along with flashing lights or signs alerting drivers about over-height restrictions, and possibly PVMS to display notification of an alternate route.

## 2.4 Benefits of SWZ

Work zones face issues of reduced roadway capacity; causing congestion and traveler delay and creating irregular traffic flow. Additionally, changing lane configurations, traffic incidents, and



factors such as slow or stopped traffic in work zones, can lead to safety hazards. SWZ applications provide actionable information to end users to reduce risk, delay and congestion, and improve safety. The FHWA<sup>3</sup> SWZ implementation guide cites various studies demonstrating benefits of using SWZ. The various applications described in Section 2.3 can be used to achieve the following benefits in a work zone:

- Increased safety to work zone personnel, emergency responders and general traffic;
- Reduced delay;
- Reduced queue length;
- Reduced congestion;
- Reduced secondary crashes;
- Improved work zone travel time;
- Improved travel speed;
- Improved traveler information; and
- Decreased incident clearance time.

## 3 CTDOT SWZ Policies

### 3.1 SWZ Goals and Objectives

CTDOT's overall SWZ goal is to improve safety for roadway users and work zone personnel, increase mobility in work zones and reduce work zone traffic incidents. SWZ goals and objectives specific to offices within CTDOT are listed below.

**Highway Operations** goals and objectives for SWZ are to:

- Obtain video feeds from work zones, where available, to maintain situational awareness of traffic flow and incidents in work zones;
- Obtain access to real-time traffic data to maintain situational awareness of traffic flow, traffic speeds, and incident detection; and
- Coordinate SWZ with existing ITS infrastructure along state roadways.

**Office of Construction** goals and objectives for SWZ are to:

- Gather data for performance measurement, including queue length, speed, volume, and delay information in work zones to create a knowledge base for roadways throughout the state;
- Manage queue length and alert vehicle entry and exit into/from construction zones;
- Obtain performance measure data points during construction and analyze and modify traffic management plans accordingly (take lanes earlier to expedite construction); and
- Facilitate incident / crash reporting.

<sup>3</sup> Work Zone Intelligent Transportation Systems Implementation Guide. FHWA-HOP-014-008. Washington D.C.: Federal Highway Administration. January 2014, Pg.21.

**Office of Traffic Engineering** goals and objectives for SWZ are to:

- Analyze the relationship between queue, volume, speed, and other traffic data collected in work zones with a goal of understanding how certain staging plans result in specific traffic patterns;
- Utilize volume data to develop generalized traffic diversion rates for various work zone types and patterns; and
- Obtain traffic data before and during staged construction to be used in developing limitation of operations for future projects.

**Federal Highway Administration** goals and objectives for SWZ are to:

- Monitor and measure performance;
- Gather crash, speed, and throughput data in work zones; and
- Reduce queue length.

## 3.2 Roles and Responsibilities

This sub-section discusses roles and responsibilities of various units within CTDOT.

**SWZ Feasibility Determination Committee:**

- A committee consisting of representatives from the Office of Traffic Engineering, Office of Construction, and Highway Operations is responsible for determining whether a project meets the criteria for the application of SWZ.
- The committee shall evaluate types of SWZ applications that should be applied to the project during the preliminary design phase and once the Maintenance and Protection of Traffic (MPT) methods have been established.
- The committee shall make recommendations to the designer on types of SWZ applications to be developed and work zone performance data to be collected for the project.
- The committee reviews SWZ design submitted as part of traffic management plans (TMP) to ensure that the initial objectives for using SWZ for the project have been addressed. The committee shall be responsible for maintaining and updating SWZ guidelines and specifications.

**Project Designer**

- The project designer shall provide the SWZ feasibility determination committee with information needed to determine whether the project meets the criteria for the application of SWZ. Information provided to the committee by the designer shall include, at a minimum, project description, project location, duration, anticipated construction staging, and preliminary cost information.
- For all projects determined to require SWZ, the designer shall develop a separate SEAFORM submittal specifically for the SWZ applications.
- The designer shall be responsible for adapting SWZ application guidelines to the specific project needs and project conditions.
- The designer shall follow all MUTCD and CTDOT standards, guidelines, and practices while developing project-specific customized plans.

**Highway Operations:**

- Owns the specifications for the SWZ bid items.
- Member of the committee that determines project-level feasibility of SWZ.

- Reviews SWZ design submitted as part of the TMP for integration with existing ITS infrastructure.
- Has access to real-time video feeds and sensor information from work zones for situational awareness and incident detection.
- Monitors operation of SWZ and reports device outages to Contractor.
- Reviews and confirms that all proposed PVMS sign locations and PVMS messages meet the MUTCD and CTDOT PVMS guidelines.

**Office of Construction:**

- Member of the committee that determines project-level feasibility of SWZ.
- Determines if coordination is needed for lane closures and construction signage between adjacent projects and adds necessary requirements in project contract documents.
- Reviews SWZ design submitted as part of the TMP.
- Reviews Average Daily Traffic (ADT) data and variance request from the Contractor during construction to allow lanes to be taken earlier in an effort to expedite construction.

**Division of Traffic Engineering:**

- Member of the team that determines project-level feasibility of SWZ.
- Reviews SWZ design submitted as part of the TMP.
- Reviews Average Daily Traffic (ADT) data and variance request from the Contractor during construction to allow lanes to be taken earlier in an effort to expedite construction.
- Participates in on-site Work Zone Safety reviews and determines work zone safety standards compliance and the potential necessary changes to be made. These inspections will also include SWZ as the systems are installed.

**District Offices:**

- Responsible for monitoring daily operations of construction and SWZ in work zones.
- Review SWZ design submitted as part of traffic management plans (TMP).
- Escalate the Contractor's request for changes to the limitations of operations to the Division of Traffic Engineering for review.
- Review periodic<sup>4</sup> work zone traffic performance reports submitted by the Contractor.
- The Engineer is responsible for making the decision to deploy or remove the SWZ or individual devices in the field.
- The Engineer approves relocation of SWZ components in work zone. Following relocation of SWZ, Engineer confirms that SWZ components and software have been reconfigured, recalibrated, and re-tested as necessary.
- Oversee coordination of lane closures and construction signage between adjacent projects as needed.

**Office of Planning:**

- Responsible for archiving work zone data.
- Utilizes archived data for planning purposes.

<sup>4</sup> Please refer to section 5.6 for further information on periodic work zone traffic performance reports.

**Contractor:**

- The Contractor's responsibilities include:
  - installation, deployment, calibration, and testing of SWZ
  - daily operations and maintenance of SWZ
  - configuration of SWZ software as directed by the Engineer and Contract requirements
  - work zone data collection, processing and archiving as directed by the Engineer and contract requirements
  - submittal of periodic work zone traffic performance reports to the District
  - responding to and fixing any failure, to provide continuous operation of SWZ as defined in the contract requirements
  - relocation, re-calibration, and re-testing of SWZ as needed (with the Engineer's approval) and as directed by the Engineer
  - removal of SWZ
- The Contractor shall request approval for the following items from the Engineer:
  - acceptance of initial SWZ testing and calibration data
  - changes to location of SWZ devices in the field
- The Contractor shall request and obtain approval for proposed PVMS sign locations and PVMS messages from the Office of Highway Operations.
- Under the direction of District Engineer, the Contractor shall coordinate lane closures and construction signage with adjacent projects as needed.

## 4 Project-Level Feasibility of SWZ

Project level feasibility determination and recommendation for SWZ will be provided by a committee comprised of members from Office of Traffic Engineering, Office of Construction, and Highway Operations.

### 4.1 Project Criteria

The Project Designer is responsible for recommending a project for evaluation by the SWZ feasibility determination committee. The committee may also recommend projects for the use of SWZ based on Department needs. Once recommended, the SWZ feasibility determination committee shall evaluate each recommended project to determine what types of SWZ applications, if any, should be applied to the project. During the evaluation process, the committee may take into consideration the criteria listed below:

- **Project cost** categories such as: (1) significant projects (>\$50 Million), (2) medium projects (\$20-\$50 Million), or (3) small projects (<\$20 Million) can be considered as a determining criterion; however, the decision on the feasibility of SWZ applications for projects is needs-based and not solely based on dollar amounts.
- **Duration of work zone** Large scale, long-term projects resulting in long term traffic issues due to complex traffic control layout.
- Projects with **staged construction** (e.g. bridge projects) resulting in frequent changes to traffic patterns and work zone traffic issues.
- **Extent of traffic impact** (traffic delay, increased travel time, queue length) due to temporary lane closure (e.g. mill and pave, deck patching on bridges)
- **Extent of queue length/delay** due to temporary signalization projects (e.g. alternate one-way traffic patterns around bridge projects, intersection improvements) or long-term MPT where lane/shoulder widths are reduced. Impact on traffic, businesses, other

destinations, or other users (e.g., extremely long delays, high risk of speed variability, access issues) for the duration of work is also a determining criterion.

- **CTDOT's internal need for traffic data** during construction on a particular roadway. In some projects, the value gained from performance data collection and evaluation may be a driving factor to implement SWZ.
- Other roadway types and traffic conditions that should be considered during the evaluation process are listed below.
  - Traffic speed variability
  - Back of queue and other sight distance issues
  - High speeds/chronic speeding
  - Work zone congestion
  - Availability of alternate routes
  - Merging conflicts and hazards at work zone tapers
  - Work zone hazards/complex traffic control layout
  - Frequently changing operating conditions for traffic
  - Variable work activities
  - Oversize vehicles (percentage of heavy vehicles >10%)
  - Construction vehicle entry/exit speed differential relative to traffic
  - Data collection for work zone performance measures
  - Unusual or unpredictable weather patterns (such as snow, ice, and fog).

## 4.2 Project Characteristics and SWZ Applications

Based on the project needs and characteristics, the committee may recommend use of one or more specific SWZ applications. The following table is adapted from FHWA Work Zone ITS Guidelines<sup>5</sup> that shows potential situations and possible mitigation measures.

CRITICAL PROJECT CHARACTERISTICS	QUEUE WARNING	REAL-TIME TRAVELER INFORMATION	INCIDENT MANAGEMENT	DYNAMIC LANE MERGE	EXCESSIVE SPEED WARNING	CONSTRUCTION VEHICLE ENTERING AND EXITING	PERFORMANCE MEASUREMENT
Frequent planned lane closures are expected, which will create queues that cause high speed differentials between queued and approaching traffic.	x	x		o	x		
Emergency shoulders will be closed through the work zone and frequent stalls and fender-benders are expected to occur that will cause queues because they cannot be quickly moved to the shoulder.	x	x	x				
Travel times and delays through the work zone will be highly variable and real-time information can improve pre-trip and real-time route choice, departure time, and possibly mode choice decisions.		x	o				
Roadway access for emergency response vehicles will be significantly constrained by the project, increasing response and clearance times.			x				
Frequent incidents are expected to occur within the project.	o	x	x				
Having an operator able to view an incident within the project and assist responders in bringing appropriate equipment to the site will significantly reduce incident duration.			x				
The potential exists for queue spillback from the work zone into upstream interchanges or intersections (and resulting in increase in cross-street congestion and rear-end crashes) due to an unequal utilization of all lanes, such that the encouragement of the use of all lanes for queue storage would reduce that probability of spillback conditions.		o	o	x			
Work activities will frequently occur for which lower speed limits would be beneficial. Drivers will need to slow down significantly prior to entering the work zone.			o		x	o	
Access to and from the work space occurs directly from the travel lanes.						x	
A high number of construction vehicle deliveries into the work space will be required during the project.						x	
The location and design of the access points could create confusion for motorists (i.e., access to the work space looks like an exit ramp and is near an existing actual exit ramp).						x	
Little or no acceleration lane is available for construction vehicles entering the travel lanes from the work space.						x	
Capacity reductions in the work zone now create an oversaturated condition due to merging ramp vehicles.		o					
Temporary ramp geometrics have constrained acceleration lane lengths.		o					
Work zone ITS is already being deployed for other purposes.							x
Project documents include traffic mobility performance requirements (i.e., maximum allowable delays) that must be monitored to ensure and quantify compliance and subsequent incentives or penalties to be issued (performance specifications of mobility impacts [delay or queues]).							x
The agency chooses the project for assessment purposes as part of its federally-mandated bi-annual process review.							x

“x”: Characteristics could be addressed with this work zone ITS application

“o”: Characteristics could be addressed with this work zone ITS application if some modification(s) were made or real-time actions taken by an operator

<sup>5</sup> Ibid, Pg. 26.



### 4.3 SWZ Applications

This section presents typical setups for various SWZ applications. For each application, a brief description of system overview, sample setup, and notes on considerations for design and deployment are provided.

NOTE: The sample SWZ applications shown in this section are overview representations and not detailed designs. The Designer and the Contractor are responsible to ensure all applicable CTDOT and MUTCD<sup>6</sup> standards, guidelines, and practices are followed in the development of SWZ plans and during field deployment.

Illustrations of SWZ applications are adapted from MUTCD standards and NHDOT SWZ Tool Box<sup>7</sup>.

The legend for the icons used in the diagrams are adapted from CTDOT Specifications for SWZ<sup>8</sup>:

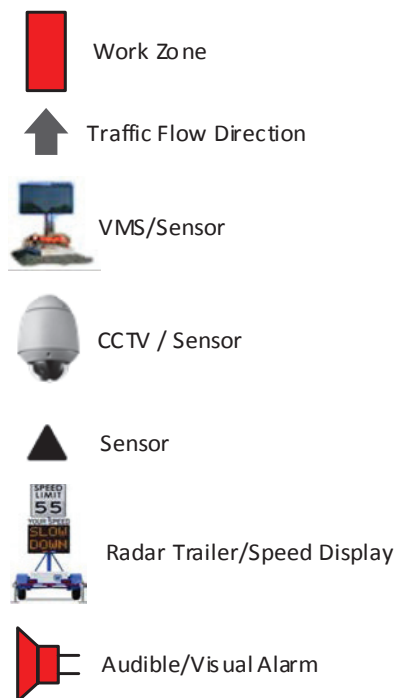

<sup>6</sup> Federal Highways Administration, U.S. Department of Transportation. Manual on Uniform Traffic Control Devices. 2009 Edition with Revisions 1 and 2, May 2012.

<sup>7</sup> New Hampshire Work Zone ITS Toolbox, Work Zone ITS Guideline for Smart Work Zone System Selection, 2011 Edition.

<sup>8</sup> CTDOT Specification for Waterbury and Bridgeport Fairfield SWZ projects.

### 4.3.1 Real-Time Traveler Information

#### REAL-TIME TRAVELER INFORMATION

**System Overview:** A typical real-time traveler information system includes sensors collecting traffic data, PVMS to display travel time through work zone, communications systems and software application to process, analyze, disseminate and archive data. Typically, PVMS is used to display estimated travel time to an exit or route prior to entering work zone.

#### Overview Diagram:

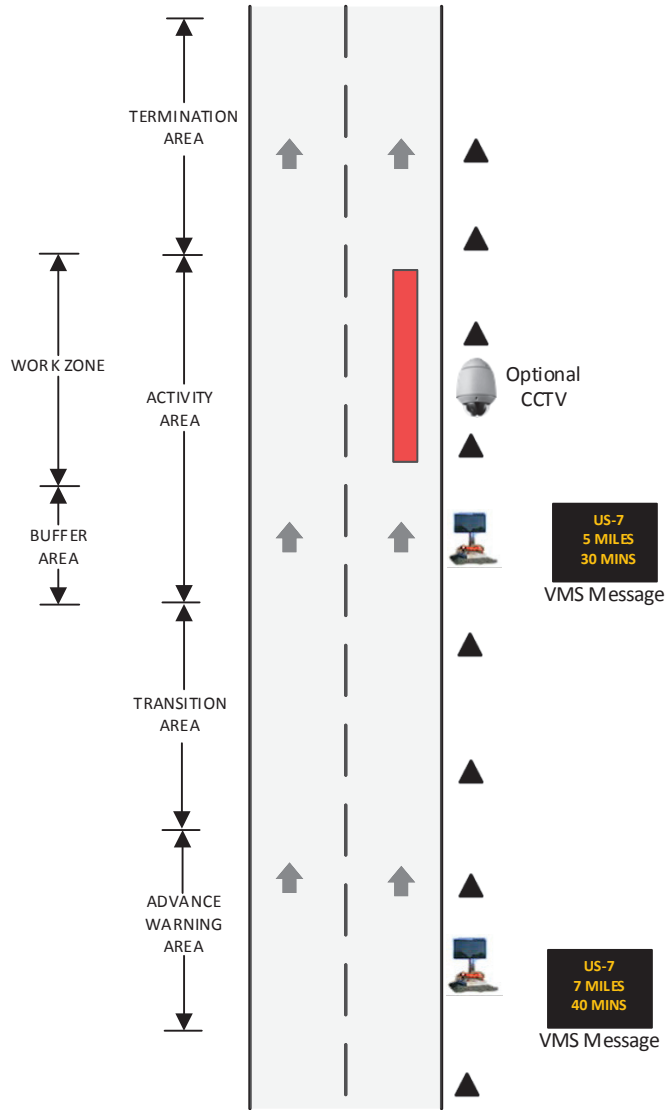

#### LEGEND

-  Work Zone
-  Traffic Flow Direction
-  Sensor
-  VMS/Sensor
-  CCTV/Sensor

#### Notes:

- Distance between sensors shall be as specified in the special provisions of the project.
- Actual number of sensors and location of sensors and PVMS are dependent on total project distance, road curvature and other specifics related to the project and roadway.
- CTDOT shall provide input to SWZ specification regarding what message shall be displayed on the PVMS at what threshold. During construction/deployment these initial requirements could be modified at the Engineer's discretion.
- CCTV camera is optional for this application. If visibility into work zone conditions is needed, CCTV on a trailer could be included as part of SWZ or an existing CCTV feed can be utilized.
- PVMS message size, legibility, etc. shall comply with CTDOT PVMS guidelines.
- As SWZ are considered to be part of temporary traffic control, the Contractor shall follow all applicable MUTCD standards and guidelines for placement of SWZ trailers at construction sites. Placement of field components shall take into consideration, requirements for off the road distance, position of SWZ equipment in relation to other highway signs, curvature of highway, ramps, etc. Final design should to be approved by CTDOT.
- Construction signage is not shown in this overview drawing and the Contractor shall follow all MUTCD and CTDOT standards, guidelines, and practices while developing the project specific customized plan.

### 4.3.2 Performance Measurement

#### PERFORMANCE MEASUREMENT

**System Overview:** A typical performance measurement system includes sensors to collect traffic data in a work zone, communications systems, and software applications for processing, analyzing, and archiving data. The data collected is mainly used for the purpose of performance measurement and to obtain insight into traffic conditions in work zones. The information is not intended for notification, but rather to allow for modifications to current project operations and future project designs.

#### Overview Diagram:

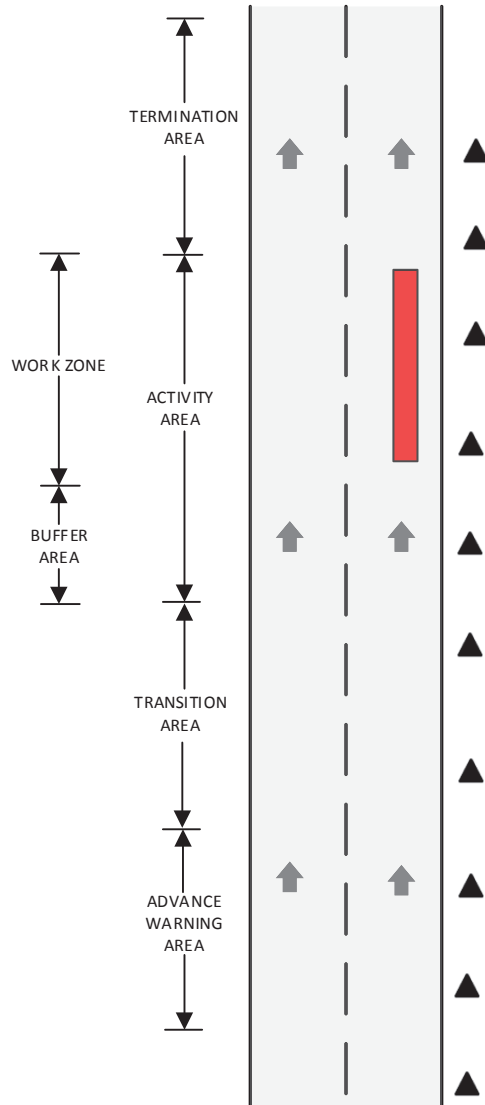

#### LEGEND

- Work Zone
- Traffic Flow Direction
- Sensor

#### Notes:

- Distance between sensors shall be as specified in the special provisions of the project.
- Actual number of sensors and location of sensors are dependent on total project distance, road curvature, and other specifics related to the project and roadway.
- CTDOT may consider the option to purchase portable sensors to implement the performance measurement SWZ application. These portable sensors could be moved to different projects and used year round to gather data from different parts of the state as needed.
- The sensors could be moved during construction/deployment at the Engineer's discretion.
- CCTV camera is optional for this application. If visibility into work zone conditions is needed, CCTV on a trailer could be included as part of SWZ or an existing CCTV feed can be utilized.
- As SWZ are considered to be part of temporary traffic control, the Contractor shall follow all applicable MUTCD standards and guidelines for placement of SWZ trailer/sensor at construction sites. Placement of field components shall take into consideration requirements for off the road distance, position of SWZ equipment in relation to other highway signs, curvature of highway, ramps, etc. Final design to be approved by CTDOT.
- Construction signage is not shown in this overview drawing and the contractor shall follow all MUTCD and CTDOT standards, guidelines, and practices while developing the project specific customized plan.

### 4.3.3 Queue Warning

#### QUEUE WARNING

**System Overview:** A typical queue warning system includes sensors to collect traffic data, PVMS to display delay/stopped traffic in the work zone, communications systems, and software applications to process, analyze, disseminate, and archive data.

#### Overview Diagram:

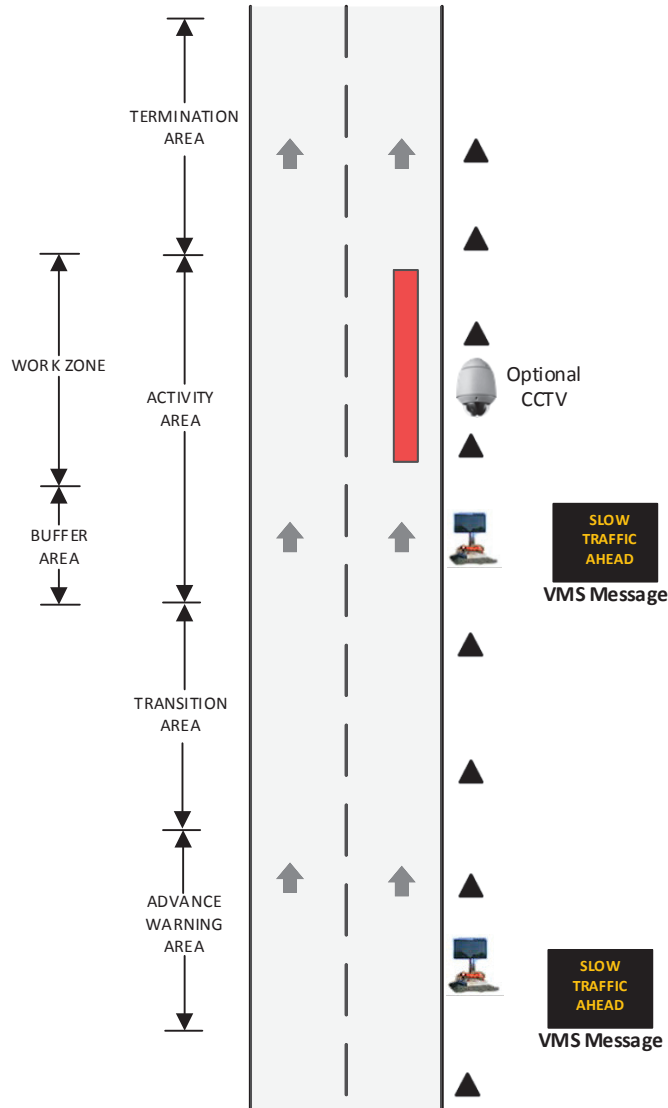

#### LEGEND

-  Work Zone
-  Traffic Flow Direction
-  Sensor
-  VMS/Sensor
-  CCTV / Sensor

#### Notes:

- Distance between sensors shall be as specified in the special provisions of the project.
- Actual number of sensors and location of sensors and PVMS are dependent on total project distance, road curvature, and other specifics related to the project and roadway.
- CTDOT shall provide input to SWZ specification regarding what message shall be displayed on the PVMS and at what threshold. During construction/deployment these initial requirements could be modified at the Engineer's discretion.
- PVMS might need relocation depending on the typical queue length observed during construction.
- CCTV camera is optional for this application. If visibility into work zone conditions is needed, CCTV on a trailer could be included as part of SWZ or an existing CCTV feed can be utilized.
- PVMS message size, legibility, etc. shall comply with CTDOT PVMS guidelines.
- As SWZ are considered to be part of temporary traffic control, the Contractor shall follow all applicable MUTCD standards and guidelines for placement of SWZ trailer/sensor at construction site. Placement of field components shall take into consideration requirements for off the road distance, position of SWZ equipment in relation to other highway signs, curvature of highway, ramps, etc. Final design to be approved by CTDOT.
- Construction signage is not shown in this overview drawing and the contractor shall follow all MUTCD and CTDOT standards, guidelines, and practices while developing the project specific customized plan.

### 4.3.4 Intrusion Detection





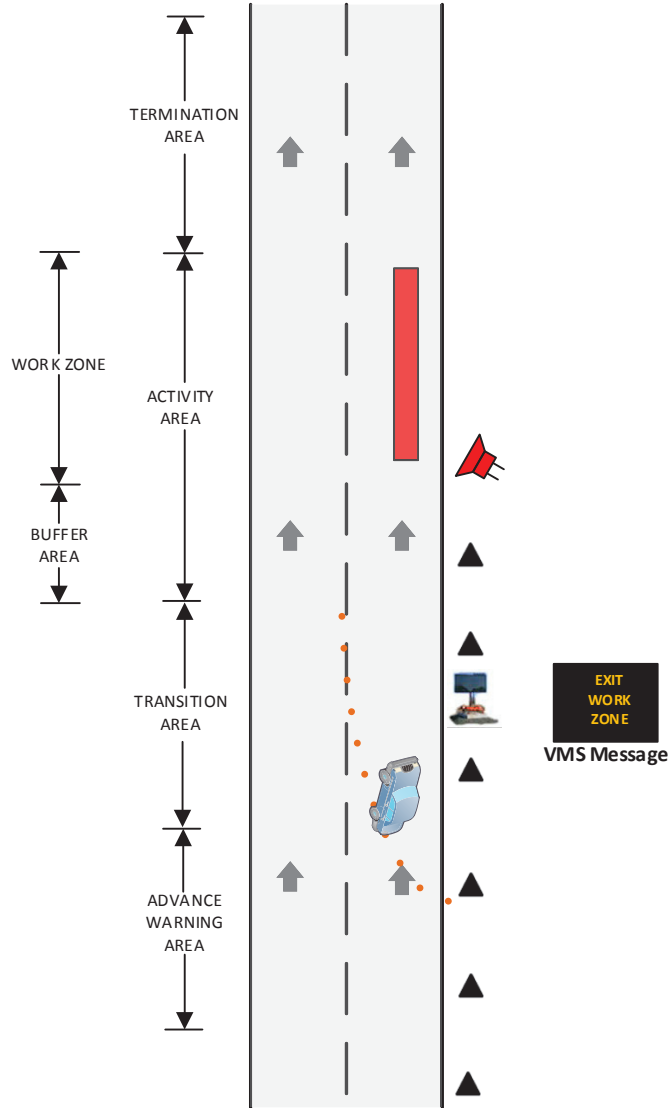

#### INTRUSION DETECTION

**System Overview:** A typical intrusion detection system includes sensors in field and speaker and/or light to notify intrusion.

**Overview Diagram:**



**LEGEND**

-  Work Zone
-  Traffic Flow Direction
-  Sensor
-  VMS/Sensor
-  Audible/Visual Alarm
-  Safety Cones

**Notes:**

- Actual number of sensors and location of sensors are dependent on total project distance, road curvature and other specifics related to the project and roadway.
- As SWZ are considered to be part of temporary traffic control, the Contractor shall follow all applicable MUTCD standards and guidelines for placement of SWZ trailer/sensor at construction site. Placement of field components shall take into consideration requirements for off the road distance, position of SWZ equipment in relation to other highway signs, curvature of highway, ramps, etc. Final design to be approved by CTDOT.
- Construction signage is not shown in this overview drawing and the contractor shall follow all MUTCD and CTDOT standards, guidelines, and practices while developing the project specific customized plan.

### 4.3.5 Excessive Speed Warning



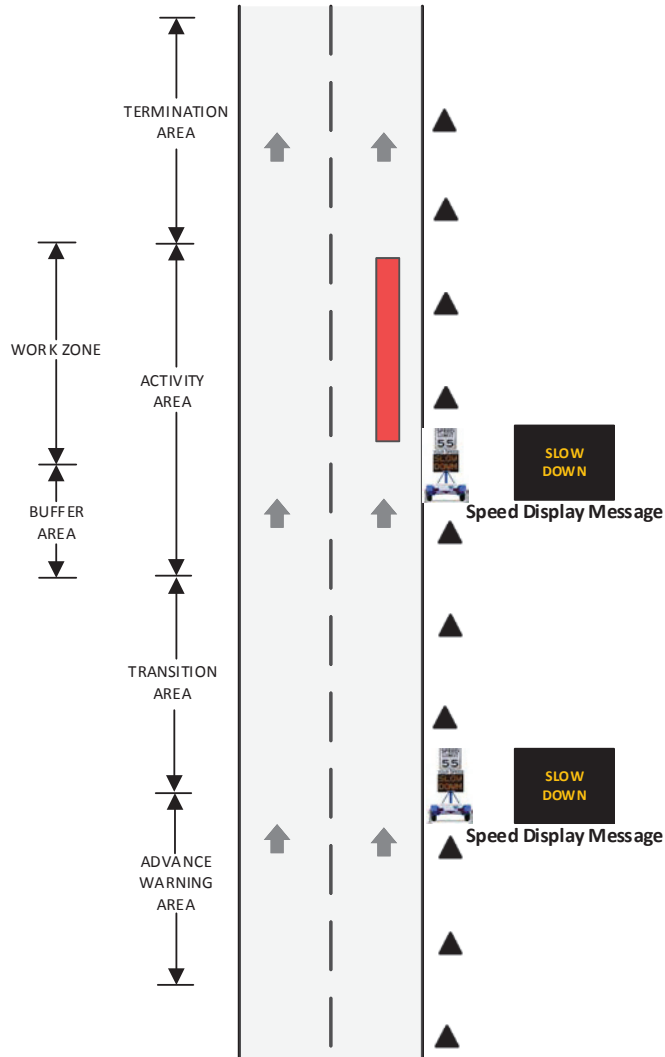

#### EXCESSIVE SPEED WARNING

**System Overview:** A typical excessive speed warning system includes sensors to collect traffic data, a radar trailer with a speed display sign to measure and display vehicle speeds and alert drivers to reduce potentially excessive speed, communications systems, and software applications to process, analyze, disseminate, and archive data.

#### Overview Diagram:



#### LEGEND

-  Work Zone
-  Traffic Flow Direction
-  Sensor
-  Radar Trailer/Speed Display

#### Notes:

- Distance between sensors shall be as specified in the special provisions of the project.
- Actual number of sensors and location of sensors and radar trailers are dependent on total project distance, road curvature, and other specifics related to the project and roadway.
- CCTV camera is optional for this application. If visibility into work zone conditions is needed, CCTV on a trailer could be included as part of SWZ or an existing CCTV feed can be utilized.
- As SWZ are considered to be part of temporary traffic control, the Contractor shall follow all applicable MUTCD standards and guidelines for placement of SWZ trailer/sensor at construction site. Placement of field components shall take into consideration requirements for off the road distance, position of SWZ equipment in relation to other highway signs, curvature of highway, ramps, etc. Final design to be approved by CTDOT.
- Construction signage is not shown in this overview drawing and the contractor shall follow all MUTCD and CTDOT standards, guidelines, and practices while developing the project specific customized plan.



### 4.3.6 Entering/Exiting Vehicle Notification

#### ENTERING/EXITING VEHICLE NOTIFICATION

**System Overview:** A typical entering/exiting vehicle notification system includes sensors in field that activate PVMS to display notification of slow moving construction or emergency vehicles, entering or exiting the roadway.

**Overview Diagram:**

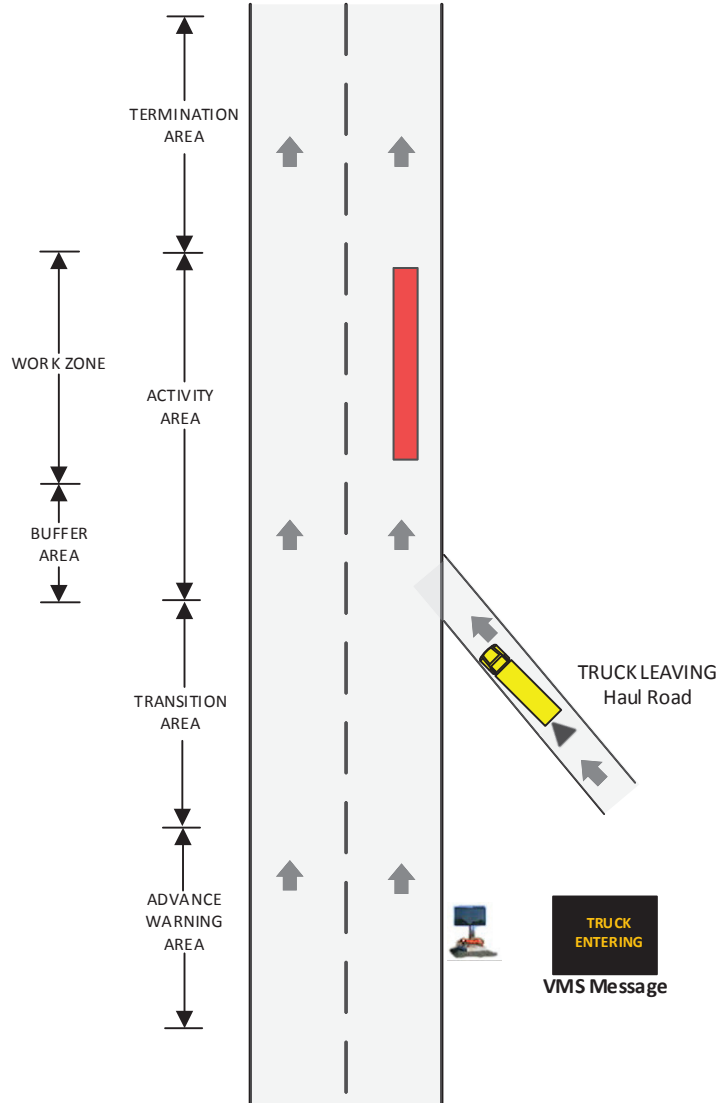

**LEGEND**

- Work Zone
- Traffic Flow Direction
- Sensor
- VMS/Sensor

**Notes:**

- Actual number of sensors and location of sensors are dependent on total project distance, road curvature, and other specifics related to the project and roadway.
- As SWZ are considered to be part of temporary traffic control, the Contractor shall follow all applicable MUTCD standards and guidelines for placement of SWZ trailer/sensor at construction site. Placement of field components shall take into consideration requirements for off the road distance, position of SWZ equipment in relation to other highway signs, curvature of highway, ramps, etc. Final design to be approved by CTDOT.
- Construction signage is not shown in this overview drawing and the contractor shall follow all MUTCD and CTDOT standards, guidelines, and practices while developing the project specific customized plan.

### 4.3.7 Over Height Vehicle Notification



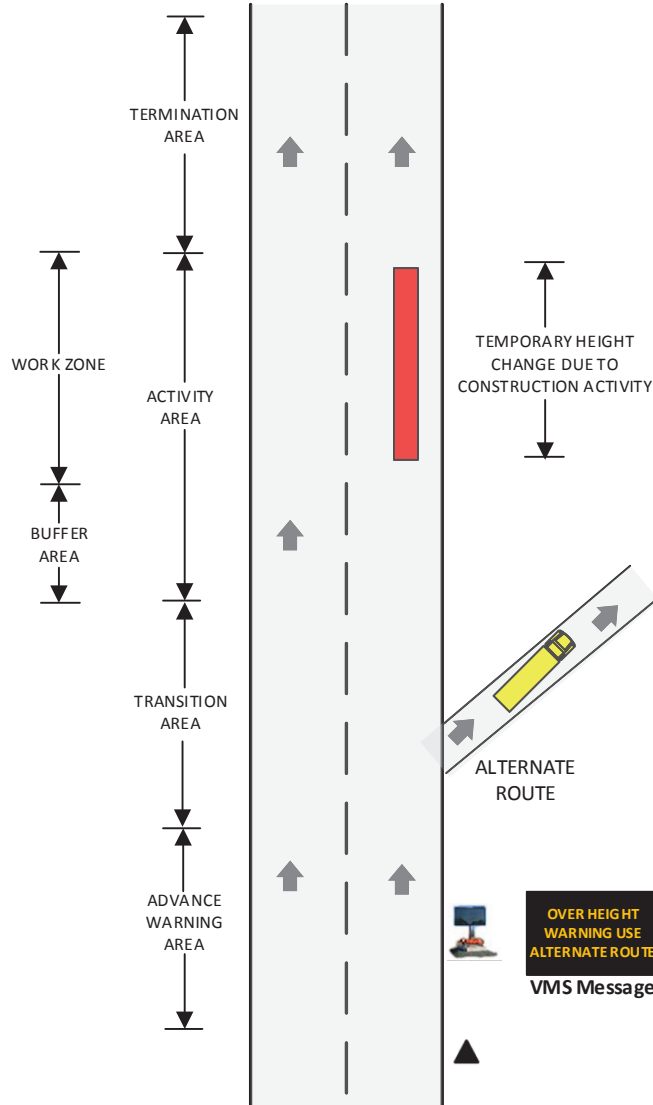

#### OVER HEIGHT VEHICLE NOTIFICATION

**System Overview:** A typical over height vehicle notification system includes sensors, PVMS to display notification with an alternate route.

**Overview Diagram:**



**LEGEND**

-  Work Zone
-  Traffic Flow Direction
-  Sensor
-  VMS/ Sensor

**Notes:**

- Actual number of sensors and location of sensors are dependent on total project distance, road curvature, access to an alternate route, and other specifics related to the project and roadway.
- As SWZ are considered to be part of temporary traffic control, the Contractor shall follow all applicable MUTCD standards and guidelines for placement of SWZ trailer/sensor at construction site. Placement of field components shall take into consideration requirements for off the road distance, position of SWZ equipment in relation to other highway signs, curvature of highway, ramps, etc. Final design should be approved by CTDOT.
- Construction signage is not shown in this overview drawing and the contractor shall follow all MUTCD and CTDOT standards, guidelines, and practices while developing the project specific customized plan.

#### 4.3.8 Other SWZ Applications

The following is a list of other SWZ application types. Some of these applications are variations of the applications described above.

- **Alternate Route:** Real-Time Traveler Information SWZ application could be extended to provide travellers with alternate route information to encourage use of alternate routes.
- **Variable Speed Limit<sup>9</sup>:** The Variable Speed Limit SWZ application allows for speed limits to be changed dynamically in work zones based on current delay and traffic speeds experienced in the work zone. A typical system includes field sensors collecting traffic data, portable variable speed limit message signs to display changing speed limits set in work zone, communications systems, and software application to process, analyze, disseminate, and archive data.
- **Congestion Advisory/Stopped Traffic Advisory:** This system uses PVMS to broadcast appropriate messages in case of congestion or stopped traffic ahead of work zone. This application is a variation of Queue Warning and Real-Time Traveler Information applications. Stopped Traffic Advisory could be used for projects which result in frequent occurrence of stopped traffic.
- **Hazardous Conditions Warning:** This SWZ application alerts hazardous conditions that might arise temporarily during construction. Examples: falling debris or temporary flooding during roadway construction.
- **Dynamic Lane Merge:** Dynamic Lane Merge SWZ application provides information to drivers to enable merging earlier or later based on current conditions in the work zone.
- **Incident Management:** Incident Management SWZ application allows for increased visibility, management, and quicker response and clearing of traffic incidents.

<sup>9</sup> Implementation would require legal review and counsel, as well as approval by the Office of the State Traffic Administration (OSTA) and possible modification to the Connecticut General Statutes.

## 4.4 Integration of Existing Permanent ITS

If existing ITS infrastructure such as CCTV and VMS (Variable Message Signs) exist within the project limits, integration with this existing infrastructure should be taken into consideration as part of SWZ design. Existing ITS may provide additional video feed and information dissemination points but they may not completely eliminate the need for CCTV or VMS as part of SWZ design, as the field equipment may not be located at the right point within the work zone. Additionally, existing VMS may have other operational uses, and may not be available for dedicated work zone use.

## 4.5 Typical SWZ Deployment Cost

Typical SWZ deployment cost depends on number of SWZ components (CCTV, sensors, PVMS, etc.) used in the system, duration of project, extent of changes to construction staging, etc. The cost details provided here are for planning purposes only and are not to be used to obtain exact cost of deployment.

- Typical SWZ costs often range between 3% and 5% of total project cost. This cost includes equipment purchase/lease and cost of mobilization, operation and maintenance. This cost will vary depending on project duration, complexity, and number of SWZ applications employed.

Some sample cost information from other DOTs and vendors:

- State of Illinois District 8 presentation “ITS Smart Work Zones”<sup>10</sup> shows that based on six projects during 2014/2015 construction season, the average cost of SWZ deployment is about 3% of total project cost.
- In the case study “Massachusetts Department of Transportation Technology Applications on the Callahan Tunnel Project”, construction Dec 2013 to Mar 2014<sup>11</sup>:
  - MassDOT procured equipment as a lump sum bid item and it accounted for 5% of total project cost. Project duration was about 4 months and deployment occurred during winter requiring maintenance.
  - MassDOT noted unit monthly costs to be in the range of:
    - Portable camera with trailer: \$1,000-\$1,300
    - PVMS, solar with remote operation: \$500-\$750
    - Queue Sensor Trailer with lane-by-lane data capture: System Operation with unlimited data plan: \$2,500 - \$3,500/month
- FHWA, Work Zone ITS Implementation Guide, Jan 2014<sup>12</sup>:
  - “As a rough estimate, purchasing a few sensors to add to an existing TMC might cost about \$5,000 plus an additional \$5,000-\$10,000 for integrating them with the existing system”.
  - “Purchasing a larger system that includes four sensors, a PVMS, and some operations support for communications and data software for a simple queue

<sup>10</sup> State of Illinois District 8 presentation “ITS Smart Work Zones” at THE Conference 2015.

<sup>11</sup> Case study: Massachusetts Department of Transportation Technology Applications on the Callahan Tunnel Project.

<sup>12</sup> Work Zone Intelligent Transportation Systems Implementation Guide. FHWA-HOP-014-008. Washington D.C.: Federal Highway Administration. January 2014.

warning system might cost about \$125,000, while doubling this to a system with eight sensors and two PVMS might increase the costs to about \$200,000”

- Vendor i-cone<sup>13</sup> offers products for owning or leasing. i-cone products are primarily used for traffic data collection.
  - Cost of owning: \$7500 per cone plus additional monthly charge of \$150 per cone or \$1500 per year for internet and data access.
  - Rent about \$1000 per cone per month. Cost of data access and wireless is included in rent/lease rate. The Contractor may require separate labor charge for mobilization.

## 5 Guidelines for Implementation of SWZ

This section defines guidelines for implementation of SWZ in the state of Connecticut. The process defined in this section allows for customization of generic SWZ applications presented in Section 4.3 to address needs and constraints specific to each project. CTDOT SWZ will closely follow federal guidelines and the Systems Engineering process for implementation of work zone ITS / SWZ. The SWZ implementation process defined in this section is presented in Appendix A in table format.

### 5.1 Design

As part of the preliminary engineering design phase and once the Maintenance and Protection of Traffic (MPT) methods have been established, the SWZ feasibility determination committee shall evaluate which types of SWZ applications should be applied to the project. The committee shall make a recommendation to the designer on types of SWZ applications to be developed for the project.

For all projects determined to require SWZ, the designer shall develop a SEAFORM specifically for the SWZ. Consistent with the May 2015 Stewardship and Oversight Implementation Manual<sup>14</sup> program responsibilities, the designer shall be responsible for following the federally required Systems Engineering process and documenting its efforts using the SEAFORM. A sample SEAFORM has been provided as Appendix C. If guidance in properly filling out the SEAFORM is needed, the person filling out the form can contact the CTDOT Office of Highway Operations.

The designer shall customize the generic SWZ application to take into consideration project-specific details such as: project length/distance, roadway geometry, traffic conditions, and other project needs. Based on this project information the designer shall determine the number and placement of sensors, PVMS, and other SWZ equipment, including an assessment of the availability of integrating the SWZ with existing ITS. The designer shall follow all MUTCD and CTDOT standards, guidelines, and practices while developing a project-specific customized plan.

The SWZ design shall be included as part of the Transportation Management Plan (TMP) for the project (as part of the detailed design). As part of TMP review, various offices within CTDOT

<sup>13</sup> Portable Work Zone Management Systems (ITS in Work Zones) Technology Review and Workshop Presentation: Background Material, IBI Group Memorandum dated August 22, 2016.

<sup>14</sup> 2015 Stewardship & Oversight Implementation Manual, Federal Highway Administration and Connecticut Department of Transportation, May 2015.

shall review and ensure construction staging is taken into consideration in development of SWZ design. The designer shall follow all applicable MUTCD and CTDOT guidelines for placement of SWZ trailers and signage at the construction site. Placement of field components shall take into consideration, clear zone requirements in the Standard Specifications Form 817, position of SWZ equipment in relation to other highway signs, curvature of highway, ramps, etc. Detailed design shall be circulated to the various CTDOT offices for review and comment, including representatives from the SWZ feasibility determination committee. Final design shall be approved by CTDOT.

## 5.2 Procurement

SWZ shall be procured under project contract as contract bid items. CTDOT has developed the following contract bid items and specifications for procurement of SWZ.

- ITEM 1131023 – Smart Work Zone Queue Trailer/Sensor (SQT)
- ITEM 1131024 – Smart Work Zone Queue Trailer/Sensor (SQT) Service
- ITEM 1131016 – Smart Work Zone Mobile Video Camera/Queue Sensor Trailer (SVQS)
- ITEM 1131017 – Smart Work Zone Mobile Video Camera/Queue Sensor Trailer (SVQS) Service
- ITEM 1131018 – Smart Work Zone Variable Message Sign/Queue Sensor Trailer (SVMQ)
- ITEM 1131019 – Smart Work Zone Variable Message Sign/Queue Sensor Trailer (SVMQ) Service
- ITEM 1131015A – Radar Speed Display – Trailer Mount, Tow Behind

Please note that this may not be a complete list of SWZ contract bid items and specifications. CTDOT Highway Operations ITS Engineering and Support should be contacted for information on any additional SWZ components. CTDOT Highway Operations ITS Engineering and Support is responsible for maintaining these specification items.

These items shall provide a fully operational SWZ that includes vehicle trailers with sensors, variable message signs (VMS), cameras, website, communications equipment, service, and maintenance as defined in the specifications. Included in the operational responsibilities of the Contractor/Vendor is the assumption of all trailer license plates, communication costs such as FCC licensing, cellular telephone, wireless data networks, satellite and internet subscription charges, solar system support and battery charging, and maintenance. Specifications for SWZ items must be customized by the designer during design stage to meet project specific criteria and needs.

## 5.3 Deployment

The District and the Engineer oversee the deployment of SWZ. The Contractor shall coordinate deployment of SWZ with the District and the Engineer. CTDOT has developed the following contract bid items and specifications for initial deployment and relocation of SWZ equipment.

- ITEM 1131020 – Smart Work Zone Deployment
- ITEM 1131022 – Smart Work Zone Trailer Relocation

Please note that this may not be a complete list of SWZ contract bid items and specifications. CTDOT Highway Operations ITS Engineering and Support should be contacted for information on any additional SWZ components. CTDOT Highway Operations ITS Engineering and Support is responsible for maintaining these specification items.



The specifications for this item provides detailed guidelines for SWZ deployment, scheduling, initial placement and relocation of equipment in work zones, calibration, testing, system demonstration, and acceptance of system prior to commencement of construction activity.

The specifications require the Contractor to complete calibration and testing of SWZ prior to initial acceptance of the deployment. If the SWZ trailer is re-located, the Contractor shall re-calibrate and test the system after each re-location. The Contractor shall obtain approval from the Engineer after each re-location, on the basis of new calibration data and testing results. The Contractor shall also notify the Highway Operations ITS Engineering and Support whenever a SWZ is deployed or re-located to ensure situational awareness at the Operations Centers is maintained.

## 5.4 Operations and Data Collection

The Contractor is responsible for SWZ operation, maintenance and data collection during construction. CTDOT has developed the following contract bid item and specification for SWZ Operations.

- ITEM 1131021 – Smart Work Zone Operations

Please note that this may not be a complete list of SWZ contract bid items and specifications. CTDOT Highway Operations ITS Engineering and Support should be contacted for information on any additional SWZ components. CTDOT Highway Operations ITS Engineering and Support is responsible for maintaining these specification items.

The Contractor shall gather, analyze, report/disseminate and archive work zone traffic data as specified in the specifications.

- Real-time traffic data such as speed, volume, count, etc. are gathered in by the SWZ at pre-configured intervals as defined in the specifications.
- The Contractor shall continuously monitor operational status of field equipment and address any outages within the duration specified in the specifications.
- The Contractor shall periodically (at a minimum on a weekly basis), review traffic queue length and delay information to make appropriate changes to location of sensors, trailers, and/or deployment of additional PVMS with approval from CTDOT.
- Throughout the duration of construction, the Contractor may evaluate traffic operations and when feasible request from the Office of Construction and District Construction variance in the hourly limitations of operation in order to expedite construction.
- The Contractor shall coordinate with the Engineer on frequency of data reporting. Typically the reporting will be on a monthly basis.
- The Contractor shall generate and submit to the Engineer a periodic work zone traffic performance report as defined in Section 5.6 utilizing work zone traffic data collected with SWZ.
- Upon project completion as per the specifications for SWZ, the Contractor shall submit full set of work zone data collected for the project. In addition to raw data set, the Contractor shall also include electronic copy of weekly reports and raw data for the week submitted to the department for archiving (XLS).
- In addition to supplying archived data in the format as specified in contract documents, the department may request the Contractor or an external Consultant to provide reports using archived data in graphical format. Appendix B shows examples of such data analysis reports. Some reports shown in the example require development of custom data analysis tools which may not be covered under the scope of the Contractor's work.

## 5.5 Security

The Contractor shall meet the following security requirements.

- The Contractor shall secure physical equipment in field with a padlock and secure software access to field devices with a high-level password.
- The SWZ operator control functions shall be high-level password protected.
- The Project SWZ website shall allow password-protected project staff to manually override the automated messaging in order to display a message at any time.

## 5.6 Maintenance and Evaluation

The Contractor is responsible for maintenance of SWZ for the duration of construction. Maintenance activities may include snow and ice removal from solar panels, maintaining batteries charged, repositioning or calibration of field equipment as needed, etc.

Data collected in work zones during construction can be used to evaluate SWZ operational performance and work zone traffic performance. When SWZ fails to meet the operational performance limits set in the contract documents, the Contractor may incur loss of payment based on terms laid out in the specifications / contract document. Evaluation of SWZ performance could also include measurement of work zone traffic performance such as number of incidents in work zone, maximum queue length, the number of lanes to remain open, maximum traveler delay, etc.

### **Periodic Work Zone Traffic Performance Report:**

The Contractor shall generate and submit to the Engineer a periodic work zone traffic performance report, utilizing the data collected with SWZ.

Short term traffic performance reports shall be submitted as part of periodic construction progress meetings. The report shall include the following:

- Periodic work zone traffic data in graphical format (plot as applicable, dependent on SWZ application selected). **The data should be submitted monthly for all the following fields except the speed trailers, which should be submitted weekly.**
  - Per Location – Sensor - Traffic Speed: Plot average traffic speed in 15 minute intervals with threshold of 45mph marked horizontally. Additionally this data can be compared against historical speed data for that roadway.
  - Project Segment - Travel Time: Plot average travel time in 15 minute intervals. Additionally this data can be compared against historical travel time for that roadway.
  - Project Segment - Delay: Plot average delay in 15 minute intervals.
  - Project Segment - Queue Length: Plot average queue length in 15 minute intervals, if queue warning system is deployed.
  - Project Segment – Number of Incidents: Plot number of incidents in 15 minute interval. Data for primary and secondary incidents (if any) shall be reported separately. This reporting is required for all SWZ applications.
  - Per Location (PVMS) – Message Logs: Submit a log of messages displayed on the PVMS and the time stamp at which the message was displayed. A short analysis and statement on accuracy of messages displayed shall be submitted along with the log, identifying any issues. If any issues (example: unexpected message such as “slow traffic” when there was no congestion reported at that

same time, inferred from low volume, etc.) are identified, the Contractor shall submit a plan of action to remedy the issue identified.

- Construction staging information for the reporting period. In the event of construction staging changes during the reporting period, the data for the two different staging plans shall be submitted separately.
- The report shall include a brief note describing any significant change in performance from prior period.
- Upon project completion as per the specifications for SWZ, the Contractor shall submit the full set of work zone data collected for the project. In addition to raw data set, the Contractor shall also include electronic copy of periodic reports and raw data for the period submitted to the department for archiving.

## 5.7 Removal

The Contractor is responsible for the removal of SWZ as part of removal of temporary traffic control. This should be coordinated with Office of Construction. Office of Construction or Office of Traffic could consider using the existing resources in field to gather useful post construction data prior to removal of SWZ. The Contractor shall also notify the Highway Operations Center when a SWZ is removed.

## REFERENCES

1. *Work Zone Intelligent Transportation Systems Implementation Guide*. FHWA-HOP-014-008. Washington D.C.: Federal Highway Administration. January 2014.
2. Federal Highways Administration, U.S. Department of Transportation. *Manual on Uniform Traffic Control Devices*. 2009 Edition with Revisions 1 and 2, May 2012.
3. Federal Highways Administration, U.S. Department of Transportation. *Portable Changeable Message Sign Handbook*. FHWA-RD-03-066. 2003.
4. New Hampshire Work Zone ITS Toolbox, Work Zone ITS Guideline for Smart Work Zone System Selection, 2011 Edition
5. Iowa DOT, Traffic Critical Projects Program 2015 Final Report.
6. CTDOT Specification for Waterbury and Bridgeport Fairfield PWZMS projects.
7. State of Illinois District 8 presentation “ITS Smart Work Zones” at THE Conference 2015. <http://www.theconf.com/presentations/2015/Experiences%20with%20Smart%20Work%20Zones%20in%20Southern%20Illinois.pdf>
8. Case study: Massachusetts Department of Transportation Technology Applications on the Callahan Tunnel Project.
9. Portable Work Zone Management Systems (ITS in Work Zones) Technology Review and Workshop Presentation: Background Material, IBI Group Memorandum dated August 22, 2016.
10. 2015 Stewardship & Oversight Implementation Manual, Federal Highway Administration and Connecticut Department of Transportation, May 2015.

# APPENDIX A – SWZ Implementation Plan

---

### Mapping Between CTDOT SWZ Guidelines and FHWA WZ ITS Guidelines Six-Steps

FHWA WORK ZONE ITS GUIDELINES SIX-STEPS	CTDOT SWZ GUIDELINES	CTDOT UNIT
Step 1: Assessment of Needs	5.1 Design	Highway Operations, District, Construction, Traffic
Step 2: Concept Development and Feasibility		Highway Operations, District, Construction, Traffic
Step 3: Detailed System Planning and Design		Highway Operations, District, Construction, Traffic
Step 4: Procurement	5.2 Procurement	District, Construction, Contractor
Step 5: System Deployment	5.3 Deployment	District, Construction, Contractor
Step 6: System Operation, Maintenance and Evaluation	5.4 Operations and Data Collection	Highway Operations, District, Construction, Contractor
	5.5 Security	District, Construction, Contractor
	5.6 Maintenance and Evaluation	District, Construction, Contractor
	5.7 Removal	District, Construction, Contractor

PROCESS	ACTIONS IN EACH STAGE
Assess Needs of the Project	<ul style="list-style-type: none"> <li>As part of the preliminary engineering and once MPT methods have been established, the SWZ feasibility determination committee shall evaluate applicability of SWZ for the project.</li> </ul>
Feasibility Review and Concept Development	<ul style="list-style-type: none"> <li>SWZ feasibility determination committee conducts a review and makes recommendations on use of SWZ and SWZ application types to be deployed.</li> </ul>
Detailed Planning and Design	<ul style="list-style-type: none"> <li>SWZ detailed plan is developed by the designer and included as part of TMP. TMP is reviewed as part of standard design review process. SWZ aspects are reviewed to ensure that SWZ objectives have been addressed.</li> </ul>
Procurement	<ul style="list-style-type: none"> <li>Equipment is procured as items in project contract bid process.</li> <li>Items for deployment, relocation, and operations are also included in the contract bid process.</li> </ul>
System Deployment and Acceptance	<ul style="list-style-type: none"> <li>The Contractor deploys system under District oversight.</li> <li>The Contractor is responsible for initial placement of equipment in work zones, calibration, testing, system demonstration and acceptance of system prior to commencement of construction activity.</li> </ul>
System Operation	<ul style="list-style-type: none"> <li>The Contractor is responsible for operations, including maintaining security.</li> </ul>
Maintenance	<ul style="list-style-type: none"> <li>The Contractor maintains equipment and websites as defined in the contract documents.</li> </ul>
Data Collection	<ul style="list-style-type: none"> <li>Automated system collects field data and archives.</li> <li>The Contractor has responsibility to collect and generate periodic work zone traffic performance reports for submittal to CTDOT.</li> </ul>



# Appendix B – Data Analysis Examples

---

SWZ collect data in real-time and archives for the duration of SWZ deployment. Typically the Contractor is not responsible for analysis and DOTs have required the Contractor to provide information in a specific format. As part of SWZ specifications, the Contractor is required to supply vendor software for the SWZ which includes data analysis and reporting functionality.

Many of the vendor provided software has ability to process and present the short-term/near-term and historical data in graphical format. Speed, volume, travel time information can be plotted graphically or presented in table format over a day/week/month/custom time frame. Additional reports such as number of times a particular type of message was posted on the PVMS, operational status of a sensor over a period of time can be generated from raw information. NH DOT (and other DOTs) use these plots and reports from vendor software to generate reports and analyze the data.

*“NHDOT collects speed, volume and occupancy data from sensors. NHDOT does not evaluate data in real time. If a pattern is seen in the data, they work with the construction personnel to make a change in traffic control. NHDOT generates a monthly reports that provides information on work zone incidents.”<sup>15</sup>*

[http://www.nhtmc.com/Dashboard/TMC\\_Operations/](http://www.nhtmc.com/Dashboard/TMC_Operations/)

Comprehensive report using historical data with custom plots requires development of custom data analysis tools which is typically not covered under the scope of the Contractor's work. Some states assign this as a task to an external consultant or collaborate with research groups in universities. Iowa DOT in collaboration with Center for Transportation Research and Education at Iowa State University (CTRE) has invested considerable effort and time to generate extensive analysis and reporting of work zone data. CTRE website contains plots with near real-time performance information (average and maximum - delay and queue length, speed heat map, sensor performance, volume, etc.). The university research center assists IOWA DOT in analysis and reporting that requires major effort.

*“IOWA DOT works with the Center for Transportation Research and Education at Iowa State University doing extensive data collection and analysis—both near real-time and long-term. Various performance measures data can be queried and plotted at the following site.”<sup>16</sup>*

<http://reactor.ctre.iastate.edu/TCP/overview.html>

<sup>15</sup> Portable Work Zone Management Systems (ITS in Work Zones) Technology Review and Workshop Presentation: Background Material, IBI Group Memorandum dated August 22, 2016.

<sup>16</sup> Ibid

Source: VER-MAC - 2013 TX DOT Waco Speed-Mac AQW PI Sheet (Project Info / Cut Sheet from Waco)

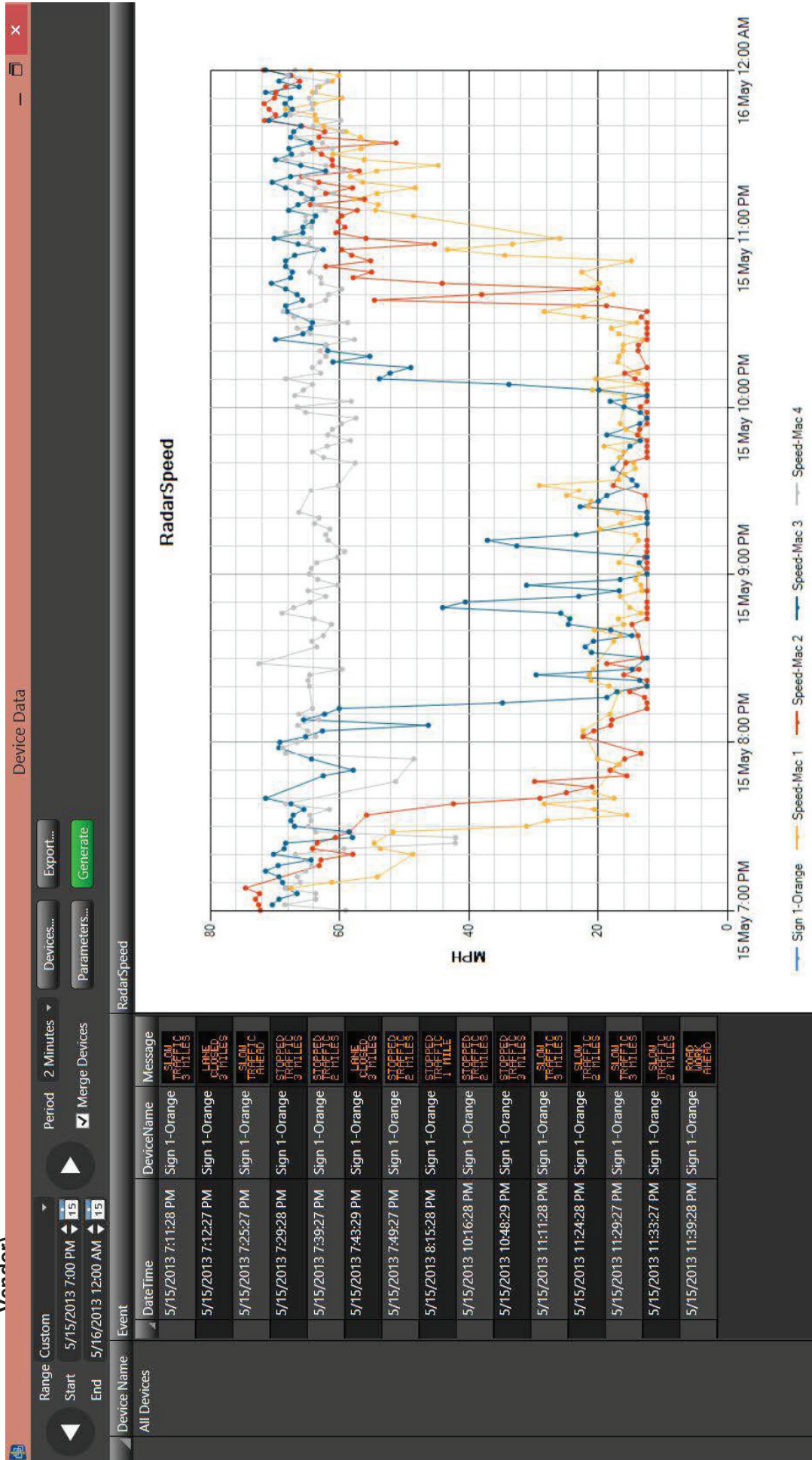



Source: VER-MAC - 2013-16 MA I-95 Whittier Bridge SWZ PI Sheet (Project Info / Cut Sheet from

The screenshot displays a traffic management software interface. At the top, a map shows the I-95 Whittier Bridge area, including locations like Seabrook Beach, Amesbury, and Newburyport. Below the map is a data table with the following columns: Name, Status, Type, Voltage, Value, and various sensor/segment identifiers. The table contains 14 rows of data, with some rows highlighted in blue and yellow.

Name	Status	Type	Voltage	Value	Other Info
I-95 Sensor 07 (S of I-495) SB/NB	Green	Sensor	13.30 V	NB 46 mph	SB 68 mph
I-95 Sensor 08 (N of I-495) SB/NB	Green	Sensor	13.20 V	NB 75 mph	SB 53 mph
I-95 Sensor 09 (N of Main St/S of Exit 60) SB/NB	Green	Sensor	13.20 V	NB 57 mph	SB 68 mph
MAIN ST EB (Prior to I-95 Ramp) PCMS 03	Green	PCMS	11.84 V	I-95 TO RTE 110 EXIT 58 2	
MAIN ST WB (Prior to Toll Rd) PCMS 04	Green	PCMS	13.82 V	5 MILES 6 MINS 1:51 PM	
NB (EB) I-495 (Prior to Exit 54) PCMS 10	Green	PCMS	12.43 V	I-95 TO RTE 286 EXIT 80 2	
NB I-495 PCMS 10 to Rte 286 (Exit 60) = Route 10	Green	Route		00:04:49	
NB I-95 (0.5 mi b4 Exit 58/Rte 110) PCMS 09	Green	PCMS	12.51 V	I-95 TO RTE 286 EXIT 80 2	
NB I-95 (Prior to Exit 54/Rte 133) PCMS 14	Green	PCMS	12.57 V	I-95 TO RTE 110 EXIT 58 2	
NB I-95 (Prior to Exit 57/Rte 113) PCMS 13	Green	PCMS	12.66 V	I-95 TO RTE 110 EXIT 58 2	
NB I-95 PCMS 11 (Rte 113/Exit 57) to (Rte 110/Exit 58)	Green	Route		00:02:20	
NB I-95 PCMS 13 to (Rte 110/Exit 58) = Route 13	Green	Route		00:03:17	
NB I-95 PCMS 14 to (Rte 110/Exit 58) = Route 14	Green	Route		00:12:40	



Source: VER-MAC - 2013-14 MA Callahan Tunnel RTTM PI Sheet (Project Info / Cut Sheet from [www.vermac.com](http://www.vermac.com))

Ver-Mac JamLogic 2.9.3344.16173 net.tcp://svr1.que.qc.ca.jamlogic.com/

File Edit View Tools Options Window ?

Begins With

Folders

- 0-SWZ - MA - Boston Call
- Overrides
- Route Segments (96)
- Ver-Mac (22)
- Virtual (18)

Tasks

Type	Status	Name	Voltage	Value	Image
		PCMS 05 - Rutherford Ave	11.92 V	DELAYS VIA TOBIN E	
		PCMS 06 Nashua St	12.11 V	EXPECT MAJOR DELAYS E	
		PCMS 07 SBRR at Ramp A	12.19 V	2 MILES 5 MIN 9:51 E	
		PCMS 08 I-93 SB at Tunnel Entrance	12.25 V	CALLAHAN TUNNEL CLOSED	
		PCMS 09 Storrow EB at Charles	12.18 V	CONSIDER RTE 1 N TOBIN E	

Map

Center on select BingMap

Properties

VmsDevice PCMS 08 I-93 SB at Tunnel Entrance

Misc

Name	Status	Last Communication	Description
PCMS 08 I-93 SB at Tunnel Entrance	OK	1/14/2014 4:51:28 PM	NE# 451

English (United States) 0-SWZ - MA - Boston Callahan Tunnel 4:52 PM (-05:00)

Source: ASTI (Screenshot-Hosting NH DOT Data)

ASTI Transportation ITS Manag... x +

astl-traffic.com/itcm/default.aspx?id=5f0b778d-d3e6-477e-b191-a56ceb30c87,fd5e3978-9043-4e20-b804-9833b518c3daf

NHDOT travel time

Map Satellite

**Map Legend**

- Speed > 45 mph
- Speed 15 to 45 mph
- Speed < 15 mph
- Inactive
- Live Video
- Roadside Alerts

**Current Message**

MOI Message

MOI device view

**3 MINS  
3 MILES  
TO US 4**

Loaded!

**Current Sensor Data**

Refreshing Data. Please Wait...

**Speed**

S Lanes Average Speed: 63

Lane #1 63

**Volume**

S Lanes Total: 1 Hourly: 50 Daily: 640

Lane #1 1

**Density**

S Lanes Average Density: 0

Lane #1 0

Loaded!

61334515i device view

61334515i Delta

Click the 'Menu' button to access available map customization options

www.nhtmc.com/Work\_Zones/travel\_time.html

334515i device view

Next update in: 32

Map data ©2016 Google

Report a map error

11:00 AM

10/13/2016



**Source i-Cone, screenshot from demo view**

The screenshot displays the i-Cone web application interface. At the top left, the i-Cone logo and tagline "THE INSTANT I.T.S. SYSTEM" are visible. Below the logo is a navigation menu with "Map", "Satellite", and "Find Out More About i-Cone®". The main area shows a map of the Dallas area with a red location marker. A popup window for "i-Cone® 0x063C" provides details: "GroupID: 70", "Project 499(NTTA-INT): DNT NB", "Location Time: 2016-07-20 06:09:00", "Data Time: 2016-07-20 12:01:00", "Avg Speed: 9 mph", "Battery: 13.562 V", and "Switch: On". A "Get Historical Report" button is also present.

Overlaid on the map are three windows:

- Advanced Settings Window:** Shows "Time Selection" (24 Hours), "Start Time: 07/19/2016 12:00", "Stop Time: 07/20/2016 12:00", "Smoothing Interval: 5 Minutes", "i-Cone Selection" (i-Cone ID: 1861), "Project Selection" (Project ID: 499), "Queuing Speed (mph): 40", "Download" options (Speed, Voltage, Reads, Temperature, Prevailing Spd\*), and "Project\*" options (Travel Time\*, Queue Length\*). It also includes "CSV" and "Graph" buttons and a note: "\*Some reports may require a specific setup. Please contact i-Cone for more details."
- Windows Photo Viewer:** Displays a line graph titled "Travel Time for Project 499" with "5 Minute Intervals". The y-axis is "Travel Time (min)" ranging from 0 to 120. The x-axis shows dates from Tue, Jul 18 to Wed, Jul 20. The graph shows a significant spike in travel time on Wednesday, July 20.
- Historical Display Window:** Contains a "Display Time:" input field, a "Show All i-Cone®:" checkbox, and a "Get Data" button. Below it, "i-Cone® Data Records" are listed with "Sample Timestamp Formats": "2013-2-18 13:20", "2/18/13 13:20", "Feb 18, 2013 1:20 PM", and "February 18, 2013 1:20 PM". "Sample i-Cone® ID Formats" are shown as "123" and "0x0ABC".

The browser's address bar shows the URL: [iconetraffic.com/maps/icon.aspx?miniLat=31.540663609639724&miniLng=-98.5499838906249658&maxLat=33.3593480353766548&maxLng=-94.38067236718746](http://iconetraffic.com/maps/icon.aspx?miniLat=31.540663609639724&miniLng=-98.5499838906249658&maxLat=33.3593480353766548&maxLng=-94.38067236718746). The browser title is "i-Cone® Reports - Mozilla Firefox".



Source: IOWA DOT/CTRE Website - Sensor Performance

**Group 5b and 5.4**

Range: 9/12/2016 to 9/18/2016

Last Updated: 9/19/2016 7:54:27 AM

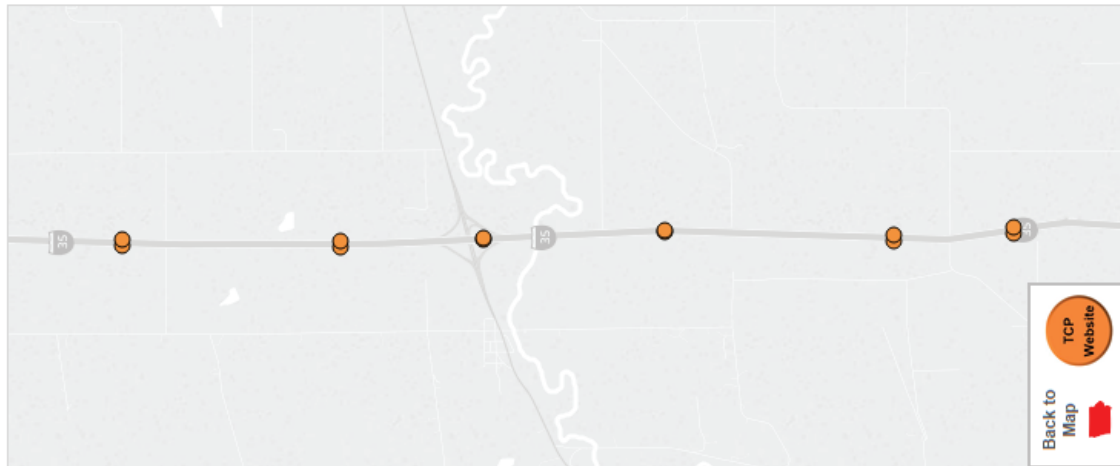

**Northbound**

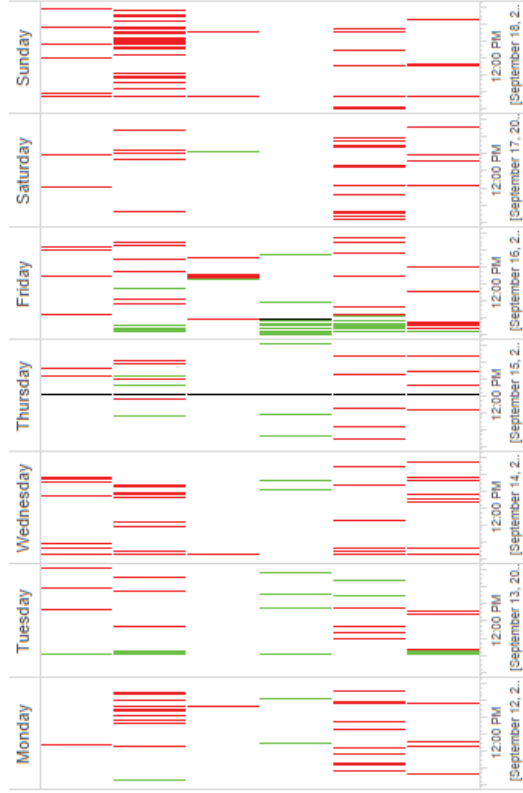

**Southbound**

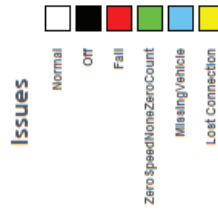
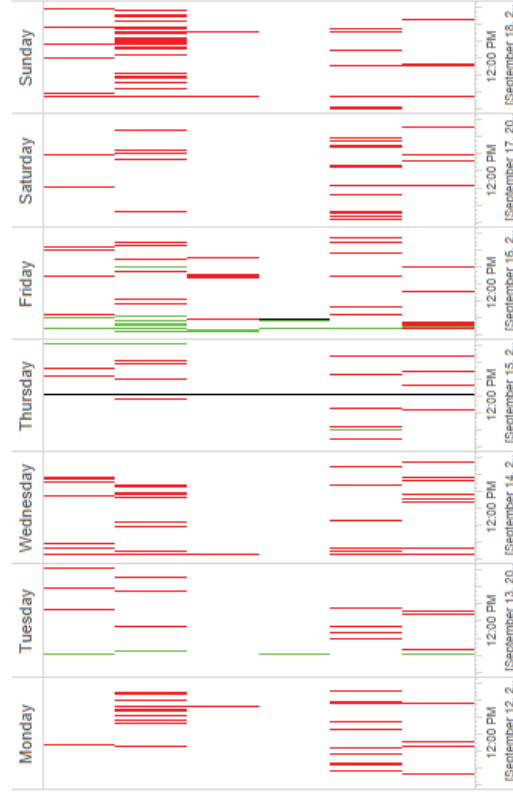

Source: IOWA DOT/CTRE Website - Heat Map  
**Group 5b and 5.4**

Range: 9/12/2016 to 9/18/2016

Last Updated: 9/19/2016 7:54:27 AM

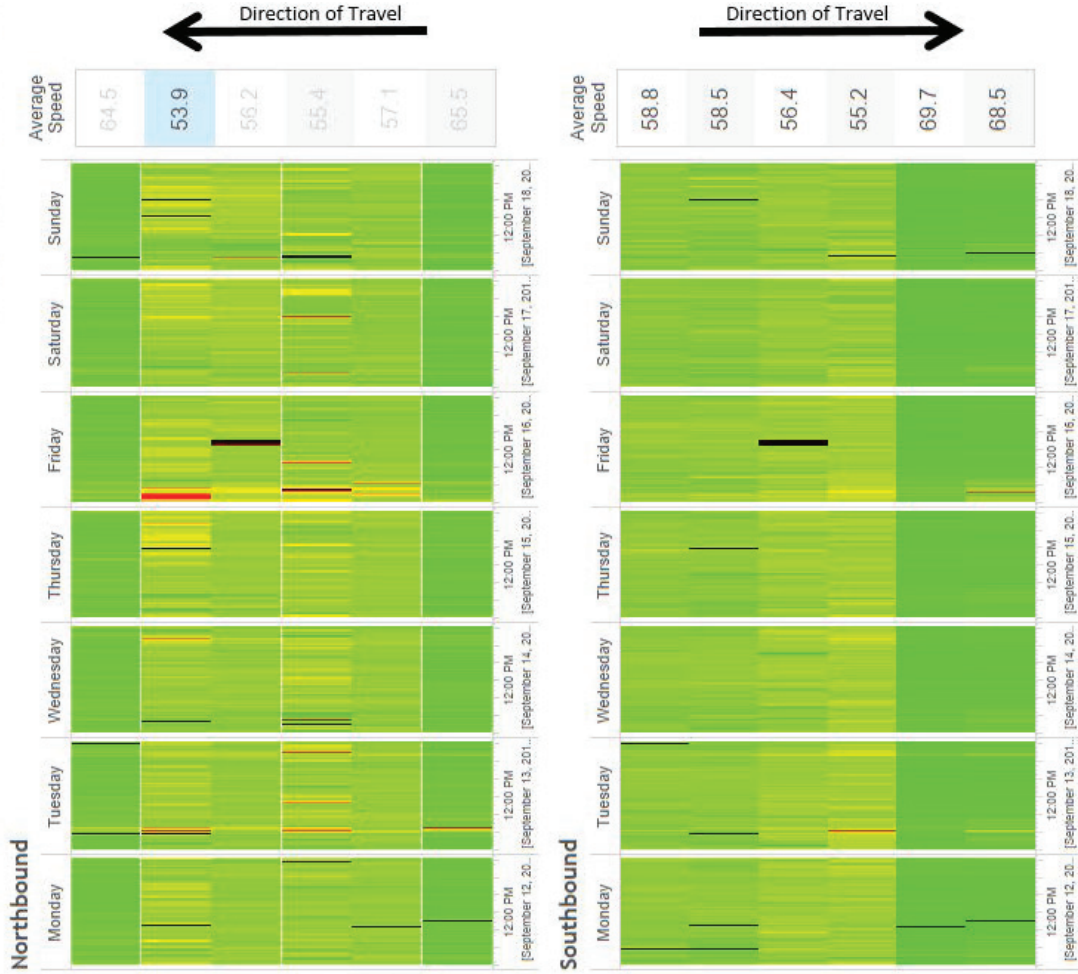
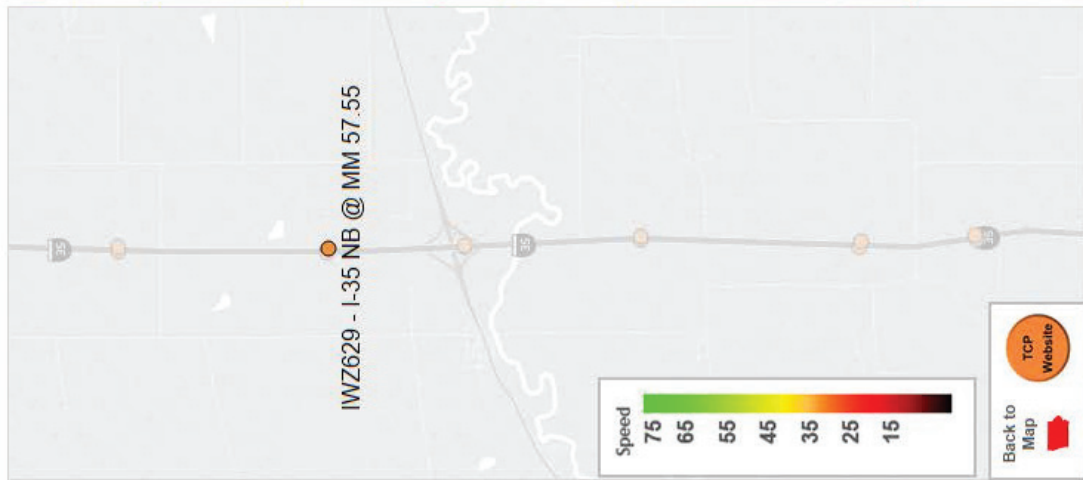

Source: IOWA DOT/CTRE Website - Daily Performance

Group 5b and 5.4

Range: 9/12/2016 to 9/18/2016

Last Updated: 9/19/2016 7:54:27 AM

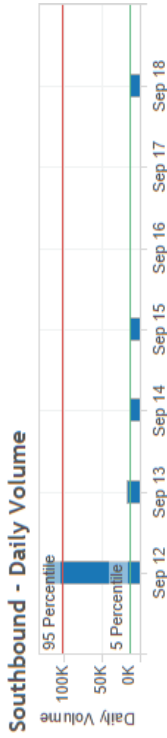
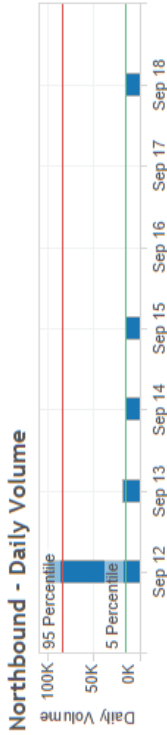

Northbound - Speed < 45 mph



Southbound - Speed < 45 mph



Northbound - Delay > 10%



Southbound - Delay > 10%



Northbound - Delay > 30%



Southbound - Delay > 30%



Northbound - Delay > 50%

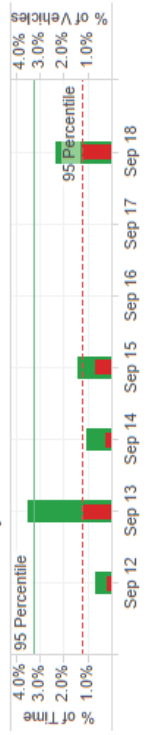

Southbound - Delay > 50%



Back to Map

TCP Website

Measure Names

- % of Time
- % of Vehicles

Source NHDOT report July 2016:

## Work Zone Communication

July 2016

### Current Month – Construction Calls

This graph shows the different types of construction related calls that dispatchers receive.

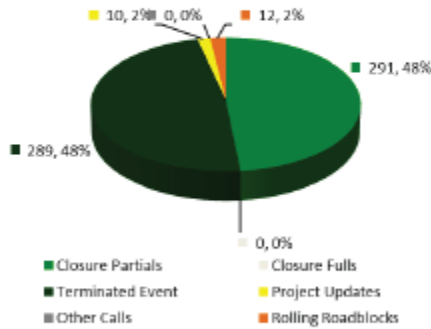

### Incidents Occurring in Work Zones

This graph shows the total number of incidents reported on Work Zone Crash Reports from the Bureau of Construction..

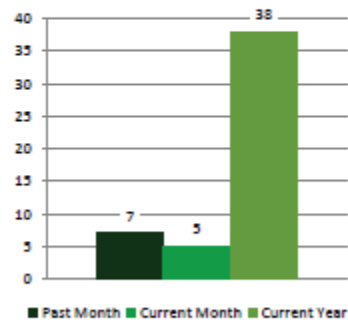

### Incidents Occurring in Work Zones by Location

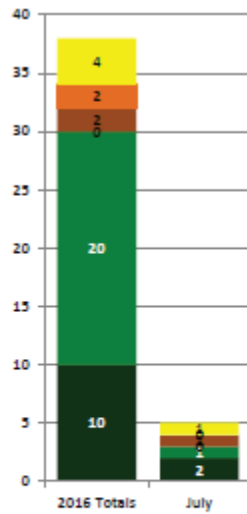

The graph to the left shows the incidents occurring in work zones by district for the current month and for the current year.

The map to the right shows the current year total for incidents occurring in work zones by district.

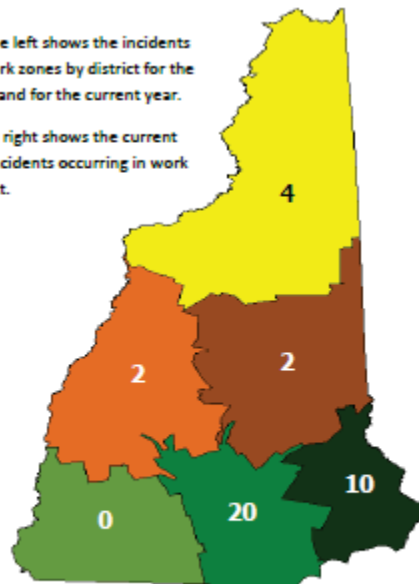

Page 7 of 9

# Appendix C – Sample SEAFORM

---

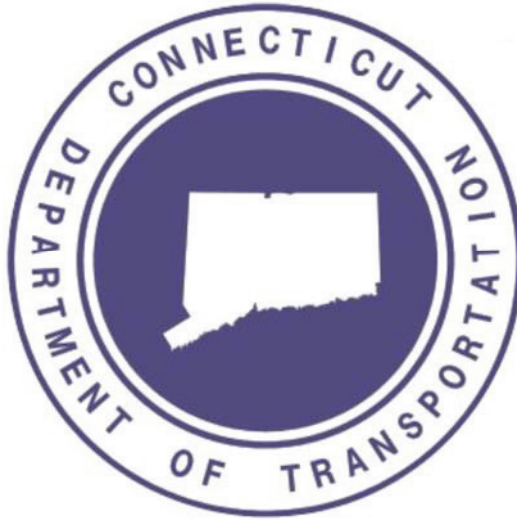

## ITS Projects – Systems Engineering Analysis FORM (SEAFORM)

The Checklist needs to be filled out by the Project Manager. Please refer to the guidance document accompanying the checklist for information on the checklist items as well as a completed example.

Project Name:		
Date	Name of Person Filling/Modifying the Form	Notes



ITS Projects – Systems Engineering Analysis FORM (SEAFORM)

**SECTION 1 – Project Information**

1.1 PROJECT TITLE

1.2 PROJECT NUMBER

- New Project  
 Modification to existing Project

1.3 BRIEF DESCRIPTION/PURPOSE

1.4 CONTACT PERSON/GROUP

1.5 PROJECT LOCATION

1.6 PERIOD OF PERFORMANCE

1.7 BUDGET & FUNDING SOURCE

1.8 NATURE OF WORK

- Scoping  Design  Software/Integration  Implementation  Operations  Evaluations  Others (Please specify)  
If Other, Please Specify

1.9 RELATIONSHIP TO OTHER PROJECTS AND PHASES

1.10 EQUIPMENT TO BE PURCHASED WITH PROJECT FUNDING

1.11 STATUS

- CMAQ  TIP/STIP Approval  
 Environmental Compliance, If applicable  FHWA Authorization  
 SLOSS/Safety Improvement

1.12 IS THERE A WORK PLAN FOR THIS PROJECT WITH TASK BREAKDOWN?

- No  
 Yes, Provide Document Reference  
 To Be Developed

**SECTION 2 – Needs Assessment**

2.1 WHAT IS/ARE THE PROBLEM(S) WITH THE CURRENT SITUATION?

2.2 WHAT NEEDS DOES THIS PROJECT ADDRESS?

2.3 HOW WERE THESE NEEDS IDENTIFIED?

- Internal CTDOT Assessment  Town / City Request  From CE Technical Review or other studies  Other

Please provide details on how needs were identified – If other documentation was used as reference, please identify it here.

**SECTION 3 – Regional Architecture Assessment and Concept Exploration**

3.1 TOWN / CITY IN CTDOT REGIONAL ARCHITECTURE INCLUDED IN DESIGN ATMS03

Included  Yes  No

Architecture is a project specific description of both logical and physical elements arranged in a hierarchical form showing inter-connections among the elements.

**3.2 INVENTORY CURRENT SYSTEMS IN CTDOT REGIONAL ARCHITECTURE INCLUDED IN PROJECT**

---

**3.3 SYSTEM IMPACTS / INTEGRATION (I.E DATA EXCHANGES) DUE TO PROJECT. PORTIONS OF ARCHITECTURE BEING IMPLEMENTED**

---

**3.4 OTHER REGIONAL ARCHITECTURES IMPACTED BY PROJECT**

NYDOT  Massachusetts  Other CTDOT Districts  CTDOT Statewide  None

Changes communicated to appropriate architecture maintenance agencies  Yes  No

---

**3.5 CHANGES RECOMMENDED TO CTDOT and/or REGIONAL ARCHITECTURES**

Yes  No

If "Yes", Please Specify and provide detail

---

**SECTION 4 – Alternative Analysis**

**4.1 WERE ANY ALTERNATE CONCEPTS/IDEAS CONSIDERED? ANY OTHER SOLUTIONS TO THE PROBLEM?**

Yes  No

Please Specify how the best concept was selected

---

**4.2 REFERENCE DOCUMENTS (IF ANY)**

---

**SECTION 5 – Concept of Operations**

**5.1 IS THERE A CONCEPT OF OPERATIONS (COO) FOR THIS PROJECT?**

Yes  No  To Be Developed

If "No" was selected, please specify reason

The Concept of Operations is a description of how the system will be used.

---

**5.2 IF "Yes" WAS SELECTED, PLEASE FILL OUT THE FOLLOWING**

COO Contains:

Scope (Geographic, Timeframe, Region etc)

- |  |  |
|--|--|
| – Description of what the project/system is expected to do | <input type="checkbox"/> Yes <input type="checkbox"/> No |
| – Roles and Responsibilities for Town / City / State       | <input type="checkbox"/> Yes <input type="checkbox"/> No |
| – Operational Scenarios                                    | <input type="checkbox"/> Yes <input type="checkbox"/> No |
| – Project/System Impacts                                   | <input type="checkbox"/> Yes <input type="checkbox"/> No |

If "No" was checked in any of the boxes, please specify reason

---

**SECTION 6 – Requirement Definitions (High-Level and Detailed)**

**6.1 ARE HIGH-LEVEL FUNCTIONAL REQUIREMENTS WRITTEN AND DOCUMENTED**

Yes  No  To Be Developed

High-level design is the transitional step between WHAT the proposed requirements i.e. Design Scope and HOW system will be implemented i.e. Preliminary Engineering, Preliminary Design, SF and FD.

---

**6.2 IF "Yes" WAS SELECTED, PROVIDE REQUIREMENTS DOCUMENT REFERENCE IF AVAILABLE**

Attached  Unavailable

---

**SECTION 7 – Detailed Design**

**7.1 IS THERE A DESIGN DOCUMENT AVAILABLE**

Yes  No  To Be Developed

Please provide reference to design document

Signal system elements, standard interfaces and System Integration structured into modules.

## 7.2 IF "YES" WAS SELECTED, PLEASE FILL OUT THE FOLLOWING

- Are the design details well documented  Yes  No  
Do the details of the design trace to requirements definitions  Yes  No  
Are boundaries and interfaces of the system clearly identified  Yes  No  
(Limit of computer, signal, camera control)  
Is there a process for Configuration Control  Yes  No  
(System Setup by Contractor or Highway ops.)

If No was checked in above boxes , please provide an explanation

---

## 7.3 DOES THE DESIGN INCORPORATE NATIONAL ITS STANDARDS

No  Yes

IF YES, Please mention what ITS Standards are being used

Standards development statuses as of May 2, 2007 [http://www.standards.its.dot.gov/Status\\_Published.asp](http://www.standards.its.dot.gov/Status_Published.asp)

NEMA/AASHTO/ITE

[Advanced Transportation Controller \(ATC\) Standard Specification for the Type 2070 Controller](#) ITE ATC Type 2070

AASHTO/ITE

[Standard for Functional Level Traffic Management Data Dictionary \(TMDD\)](#) ITE TM 1.03

[Message Sets for External TMC Communication \(MS/ETMCC\)](#) ITE TM 2.01

AASHTO/ITE/NEMA

[Transportation Management Protocols \(TMP\)](#) NTCIP 1103

[Center-to-Center Naming Convention Specification](#) NTCIP 1104

[Object Definitions for Signal Control and Prioritization \(SCP\)](#) NTCIP 1211

[Structure and Identification of Management Information](#) NTCIP 8004

[Testing and Conformity Assessment Documentation within NTCIP Standards Publications](#) NTCIP 8007

ANSI

[Commercial Vehicle Safety Reports](#) ANSI TS284

[Commercial Vehicle Safety and Credentials Information Exchange](#) ANSI TS285

[Commercial Vehicle Credentials](#) ANSI TS286

APTA

[Standard for Transit Communications Interface Profiles](#) APTA TCIP-S-001 3.0.0

ASTM

[Standard Specification for Dedicated Short Range Communication \(DSRC\) Physical Layer using Microwave in the 902-928 MHz Band](#) ASTM

E2158-01

[Standard Specification for Telecommunications and Information Exchange Between Roadside and Vehicle Systems - 5 GHz Band Dedicated Short](#)

[Range Communications \(DSRC\) Medium Access Control \(MAC\) and Physical Layer \(PHY\) Specifications](#) ASTM E2213-03

[Standard Guide for Archiving and Retrieving ITS-Generated Data](#) ASTM E2259-03

[Standard Practice for Metadata to Support Archived Data Management Systems](#) ASTM E2468-05

EIA

[Data Radio Channel \(DARC\) System](#) EIA 794

[Subcarrier Traffic Information Channel \(STIC\) System](#) EIA 795

IEEE

[Standard for Message Sets for Vehicle/Roadside Communications](#) IEEE 1455-1999

[Standard for Common Incident Management Message Sets for use by Emergency Management Centers](#) IEEE 1512 -2006

[Standard for Traffic Incident Management Message Sets for Use by Emergency Management Centers](#) IEEE 1512.1-2006

[Standard for Public Safety Traffic Incident Management Message Sets for Use by Emergency Management Centers](#) IEEE 1512.2-2004

[Standard for Hazardous Material Incident Management Message Sets for Use by Emergency Management Centers](#) IEEE 1512.3-2006

[Standard for the Interface Between the Rail Subsystem and the Highway Subsystem at a Highway Rail Intersection](#) IEEE 1570-2002

[Standard for Wireless Access in Vehicular Environments \(WAVE\) - Resource Manager](#) IEEE 1609.1-2006

[Standard for Wireless Access in Vehicular Environments \(WAVE\) - Security Services for Applications and Management Messages](#) IEEE 1609.2-

2006

[Standard for Wireless Access in Vehicular Environments \(WAVE\) - Multi-Channel Operation](#) IEEE 1609.4-2006

[Standard for Wireless Access in Vehicular Environments \(WAVE\) - Networking Services](#) IEEE P1609.3

[The Survey and Analysis of Existing Standards and those Under Development Applicable to the Needs of the Intelligent Transportation System \(ITS\)](#)

[Short Range and Wide Area Wireless and Wireline Technologies](#) IEEE SH94633-SH94638

NEMA/AASHTO/ITE

[Advanced Transportation Controller \(ATC\)](#) ITE ATC Controller 5.2

[ITS Standard Specification for Roadside Cabinets](#) ITE ITS Cabinet

AASHTO/ITE

[TMDD & MS/ETMCC Guide Standard for Functional Level Traffic Management Data Dictionary \(TMDD\) and Message Sets for External Traffic](#)

[Management Center Communications](#) ITE TMDD Guide

AASHTO/ITE/NEMA

[Simple Transportation Management Framework \(STMF\)](#) NTCIP 1101

[Octet Encoding Rules \(OER\) Base Protocol](#) NTCIP 1102

[Global Object Definitions](#) NTCIP 1201

[Object Definitions for Actuated Traffic Signal Controller \(ASC\) Units](#) NTCIP 1202

[Object Definitions for Dynamic Message Signs \(DMS\)](#) NTCIP 1203

[Object Definitions for Environmental Sensor Stations \(ESS\) NTCIP 1204](#)  
[Object Definitions for Closed Circuit Television \(CCTV\) Camera Control NTCIP 1205](#)  
[Object Definitions for Data Collection and Monitoring \(DCM\) Devices NTCIP 1206](#)  
[Object Definitions for Ramp Meter Control \(RMC\) Units NTCIP 1207](#)  
[Object Definitions for Closed Circuit Television \(CCTV\) Switching NTCIP 1208](#)  
[Data Element Definitions for Transportation Sensor Systems \(TSS\) NTCIP 1209](#)  
 APTA  
[TCIP Framework Standard NTCIP 1400](#)  
[TCIP Common Public Transportation \(CPT\) Objects NTCIP 1401](#)  
[TCIP Incident Management \(IM\) Objects NTCIP 1402](#)  
[TCIP Passenger Information \(PI\) Objects NTCIP 1403](#)  
[TCIP Scheduling/Runcutting \(SCH\) Objects NTCIP 1404](#)  
[TCIP Spatial Representation \(SP\) Objects NTCIP 1405](#)  
[TCIP On-Board \(OB\) Objects NTCIP 1406](#)  
[TCIP Control Center \(CC\) Objects NTCIP 1407](#)  
[TCIP Fare Collection \(FC\) Business Area Objects NTCIP 1408](#)  
 AASHTO/ITE/NEMA  
[Class B Profile NTCIP 2001](#)  
[Point to Multi-Point Protocol Using RS-232 Subnetwork Profile NTCIP 2101](#)  
[Point to Multi-Point Protocol Using FSK Modem Subnetwork Profile NTCIP 2102](#)  
[Point-to-Point Protocol Over RS-232 Subnetwork Profile NTCIP 2103](#)  
[Ethernet Subnetwork Profile NTCIP 2104](#)  
[Transportation Transport Profile NTCIP 2201](#)  
[Internet \(TCP/IP and UDP/IP\) Transport Profile NTCIP 2202](#)  
[Simple Transportation Management Framework \(STMF\) Application Profile NTCIP 2301](#)  
[Trivial File Transfer Protocol \(TFTP\) Application Profile NTCIP 2302](#)  
[File Transfer Protocol \(FTP\) Application Profile NTCIP 2303](#)  
[Application Profile for DATEX-ASN \(AP-DATEX\) NTCIP 2304](#)  
[Profile Framework NTCIP 8003](#)  
[NTCIP Guide NTCIP 9001](#)  
[XML in ITS Center-to-Center Communications NTCIP 9010](#)  
 SAE  
[Truth-in-Labeling Standard for Navigation Map Databases SAE J1663](#)  
[Serial Data Communications Between Microcomputer Systems in Heavy-Duty Vehicle Applications SAE J1708](#)  
[ISP-Vehicle Location Referencing Standard SAE J1746](#)  
[Standard Metrology for Vehicular Displays SAE J1757](#)  
[ITS Data Bus Data Security Services SAE J1760](#)  
[Location Referencing Message Specification \(LRMS\) SAE J2266](#)  
[On-Board Land Vehicle Mayday Reporting Interface SAE J2313](#)  
[Mayday Industry Survey Information Report SAE J2352](#)  
[Message Set for Advanced Traveler Information System \(ATIS\) SAE J2354](#)  
[ITS Data Bus Architecture Reference Model Information Report SAE J2355](#)  
[Calculation of the Time to Complete In-Vehicle Navigation and Route Guidance Tasks SAE J2365](#)  
[ITS Data Bus - IDB-C Physical Layer SAE J2366/1](#)  
[ITS Data Bus - Low Impedance Stereo Audio SAE J2366/1L](#)  
[ITS Data Bus - Link Layer SAE J2366/2](#)  
[ITS Data Bus - Thin Transport Layer SAE J2366/4](#)  
[ITS Data Bus - Application Message Layer SAE J2366/7](#)  
[Standard for ATIS Message Sets Delivered Over Reduced Bandwidth Media SAE J2369](#)  
[Field Test Analysis Information Report SAE J2372](#)  
[Stakeholders Workshop Information Report SAE J2373](#)  
[ITS In-Vehicle Message Priority SAE J2395](#)  
[Definitions and Experimental Measures Related to the Specification of Driver Visual Behavior Using Video Based Techniques SAE J2396](#)  
[Adaptive Cruise Control \(ACC\) Operating Characteristics and User Interface SAE J2399](#)  
[Human Factors in Forward Collision Warning Systems: Operating Characteristics and User Interface Requirements SAE J2400](#)  
[Comparison of GATS Messages to SAE ATIS Standards Information Report SAE J2539](#)  
[Messages for Handling Strings and Look-Up Tables in ATIS Standards SAE J2540](#)  
[RDS \(Radio Data System\) Phrase Lists SAE J2540/1](#)  
[ITIS \(International Traveler Information Systems\) Phrase Lists SAE J2540/2](#)  
[National Names Phrase List SAE J2540/3](#)  
[Converting ATIS Message Standards from ASN.1 to XML SAE J2630](#)  
[Dedicated Short Range Communications \(DSRC\) Message Set Dictionary SAE J2735](#)

Turbo Architecture – “Standards Report”  Attached  Unavailable

**7.4 DOES THE DESIGN INCORPORATE ANY CTDOT STANDARDS**

No  Yes,

IF Yes, Please mention what CTDOT Standards are being used

**SECTION 8 – Implementation**

**8.1 PROCURMENT DETAILS**

(i.e. Competitive Low Bid)

**8.2 REFERENCE DOCUMENTS (IF ANY)**

Turbo Architecture – “List of Agreements”  Attached  Unavailable

**SECTION 9 – Integration and Test**

**9.1 IS THERE AN INTEGRATION PLAN**

No  Yes  To Be Developed

If “Yes” Please provide reference

An Integration Plan as a separate written document is not always needed. The complexity of the system, the complexity of the eventual deployment of the system and the complexity of the development effort, influence the decision to prepare an Integration Plan.

Integration Plan includes and covers integration of all of the components and sub-systems either developed or purchased of the project.

Account for all external systems to be integrated with the system (i.e. communications networks, field equipment and other systems owned by controlling agency.)

An Integration Plan should identify all participants, define what their roles and responsibilities are, establish the sequence - schedule for every integration step and document how integration problems are recorded and resolved.

**9.2 IS THERE A TEST PLAN**

No  Yes  To Be Developed

If “Yes” Please provide reference

**SECTION 10 – System Verification and Acceptance**

**10.1 IS THERE A SYSTEM VERIFICATION AND ACCEPTANCE PLAN (verification of the entire system and acceptance criteria)**

No  Yes  To Be Developed

If “Yes” Please provide reference

(i.e. Signal, Construction checklist)

**10.2 IF YES, PLEASE FILL OUT THE FOLLOWING**

- Is there a clear criteria for completion  Yes  No
- Are there clear performance metrics for system acceptance  Yes  No
- Will there be adequate system documentation for all users and maintainers  Yes  No

If No was checked in above boxes , please provide an explanation

**SECTION 11 – Operations and Maintenance**

**11.1 WHO WILL MAINTAIN THE SYSTEM**

**11.2 IS THERE A SCHEDULE FOR UPGRADES/ENHANCEMENTS TO THE SYSTEM**

**11.3 WILL THERE BE AN EVALUATION OF THE SYSTEM**



Prepared for Connecticut Department of Transportation  
by IBI Group



**Massachusetts Department of Transportation**

Smart Work Zone Design Standards – February 2016

[https://www.workzonesafety.org/files/documents/SWZ/swz\\_design\\_standards\\_MassDOT.pdf](https://www.workzonesafety.org/files/documents/SWZ/swz_design_standards_MassDOT.pdf)

Smart Work Zone Standard Operating Procedures – February 2016

[https://www.workzonesafety.org/files/documents/SWZ/swz\\_standard\\_operating\\_procedures\\_MassDOT.pdf](https://www.workzonesafety.org/files/documents/SWZ/swz_standard_operating_procedures_MassDOT.pdf)

Scoring Criteria for Work Zone ITS

[https://www.workzonesafety.org/files/documents/SWZ/MassDOT\\_scoring\\_criteria.pdf](https://www.workzonesafety.org/files/documents/SWZ/MassDOT_scoring_criteria.pdf)



# **Smart Work Zone**

# **Design Standards**

Version 1.1  
February 2016

## TABLE OF CONTENTS

Acronyms .....	iii
1. Introduction .....	1
2. Overview of SWZs .....	5
3. Application to MassDOT Projects .....	15
4. Layout & Design Guidelines .....	17
5. References .....	23
Appendix A: Typical SWZ Setups for Safety and Mobility Applicaitons .....	25

## LIST OF TABLES

Table 1: SWZ Mobility Applications .....	6
Table 2: SWZ Safety Applications .....	7
Table 3: SWZ Planning & Monitoring Applications .....	8
Table 4: Detection and Surveillance Equipment Used in SWZs .....	9
Table 5: Data Requirements in SWZ Applications .....	11
Table 6: Information Dissemination Devices/Systems Used in SWZs .....	12
Table 7: Dissemination Devices in SWZ Applications .....	13
Table 8: Required SWZ Functions Based on Project Impact Levels .....	15
Table 9: Optional SWZ Functions Based on Hazards Present .....	15
Table 10: Equipment Location .....	17

## LIST OF FIGURES

Figure 1: Work Zone Traffic .....	1
Figure 2: Process for Designing and Operating SWZs at MassDOT .....	2
Figure 3: Context for MassDOT SWZ Design Standards .....	4
Figure 4: Typical Smart Work Zone Architecture .....	5
Figure 5: Portable Traffic Sensor (PTS) (microwave) and an iCone® (radar) .....	10
Figure 6: Portable Video Camera (PVC) .....	10
Figure 7: Portable Changable Message Sign (PCMS) & Hybrid Message Sign (HMS) .....	13
Figure 8: Key for Layout Diagrams .....	18
Figure 9: Typical SWZ setup for a Project Level 3 .....	19
Figure 10: Typical SWZ setup for a Project Level 4 or Significant Project Status .....	20

## APPENDIX A

- Exhibit 1: Critical Project Characteristics and Work Zone ITS Applications
- Exhibit 2: Smart Work Zone Scoring Matrix

## ACRONYMS

AASHTO	American Association of State Highway and Transportation Officials
CCTV	Closed-circuit Television
CMO	Construction Management Outline
DOT	Department of Transportation
FHWA	Federal Highway Administration
GPS	Global Positioning System
HAR	Highway Advisory Radio
HMS	Hybrid Message Sign
IMP	ITS Monitoring Plan
ITS	Intelligent Transportation System
MassDOT	Massachusetts Department of Transportation
MUTCD	Manual on Uniform Traffic Control Devices
PCMS	Portable Changeable Message Sign
PIP	Public Informational Plan
PTS	Portable Queue Trailer
RFID	Radio-frequency Identification
SOP	Standard Operating Procedures
SWZ	Smart Work Zone
TMP	Traffic Management Plans
TTCP	Temporary Traffic Control Plan
USDOT	United States Department of Transportation
XML	Extensible Markup Language

**Acknowledgement** – The Smart Work Zone Design Standards were developed by Kanaan Consulting US, Inc. in cooperation with the MassDOT Traffic and Safety Engineering Section.

## 1. INTRODUCTION

Roadway construction can cause traffic delays and safety hazards. Agencies across the country are using portable Intelligent Transportation Systems (ITS) to monitor and improve work zone performance. These Smart Work Zones (SWZ) – collections of computer, communication, and sensor technologies – are used to alert road users about construction activities so that they can slow down and take alternate routes. Agencies also use SWZ to monitor traffic conditions for planning and oversight purposes.

The Massachusetts Department of Transportation (MassDOT) first deployed a SWZ to assist with the Sagamore Bridge construction project and provide motorist information on Route 6 westbound in 2009. MassDOT's first large-scale SWZ was utilized during the Interstate 93 Fast14 project in the summer of 2011. Based on the success of these deployments, MassDOT procured a set of SWZ equipment to deploy as needed during to assist the District Construction Offices with providing real-time information feedback to motorists. In addition, MassDOT began to include SWZ specifications in other accelerated construction projects where contractors were required to deploy them as part of the traffic management plan.

MassDOT's primary goal for the SWZs is to improve customer service. Experience with the Fast 14 and pilot installations in 2012 and 2013 have indicated that motorists are less likely to become aggravated when they are made aware of delays in travel time during construction. SWZs are the most efficient way to tell motorists about traffic conditions. The use of SWZs also allows MassDOT to collect large quantities of data about traffic conditions in and around work zones for internal planning and monitoring purposes.



Figure 1: Work Zone Traffic<sup>1</sup>

### 1.1 Purpose

This document provides guidance for designing SWZ layouts that are helpful to the public and capable of collecting the data that MassDOT needs to better evaluate and plan for future construction impacts. It is organized as follows:

- Section 1 provides background and context.
- Section 2 describes SWZs and what they do.
- Section 3 explains how to use SWZs at different types of projects.

<sup>1</sup> Photo by Tracy Scriba, FHWA (<http://www.fhwa.dot.gov/publications/publicroads/07july/05.cfm>)

- Section 4 includes detailed guidance for planning the layout of SWZ equipment.

The *Smart Work Zone Standard Operating Procedures*, a companion guide to this document, provides more detail to the contractor on the deployment and operation of a SWZ. *Figure 2* shows the process as described in the two documents.

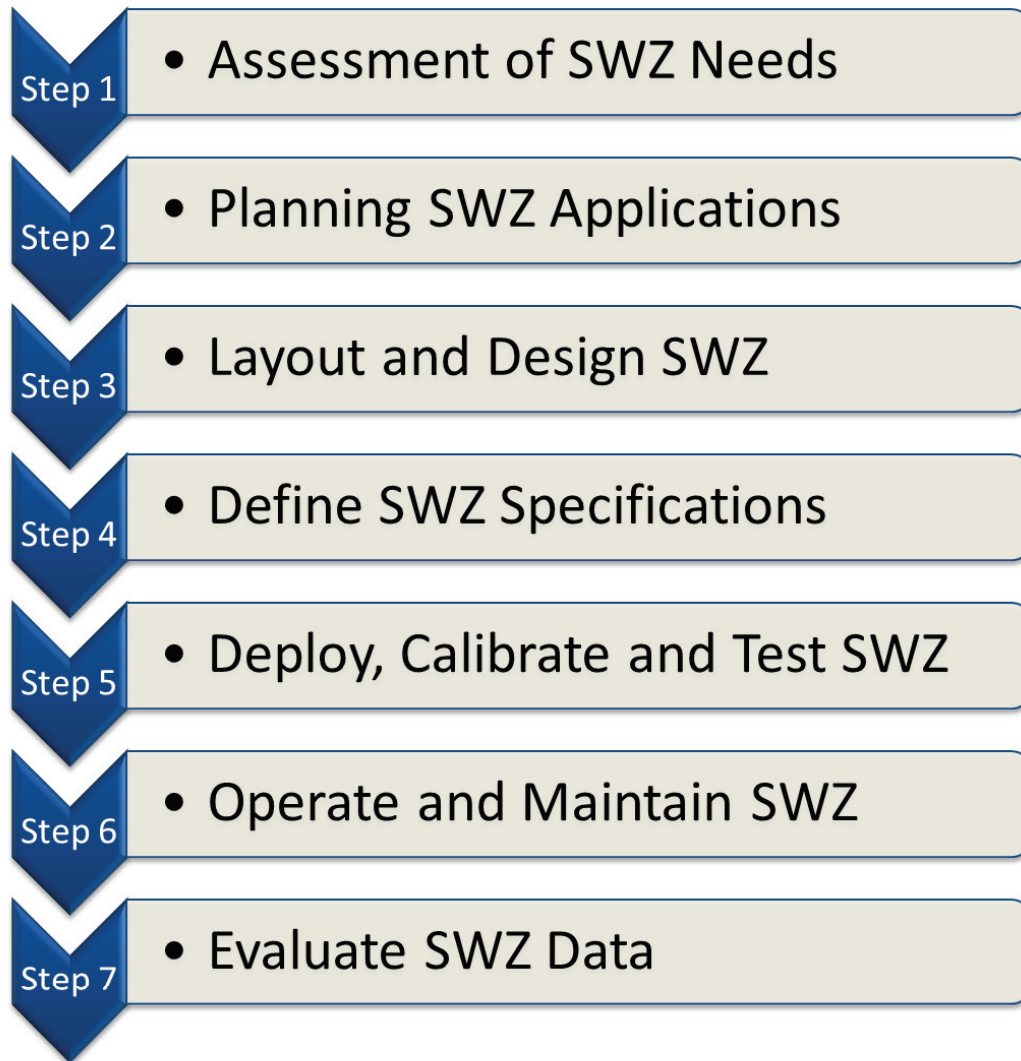

Figure 2: Process for Designing and Operating SWZs at MassDOT



## 1.2 Background

### 1.2.1 Federal Highway Administration (FHWA)

In September 2004, the FHWA updated the *Work Zone Safety and Mobility Rule 23 CFR 630 Subpart J*. The Rule applies to all state and local governments that receive Federal-aid highway funding. This state and local transportation agencies were required to comply with the provisions of the Rule by October 12, 2007. The Rule identifies ITS as a work zone strategy to minimize construction impacts upon traffic flow.

FHWA has also made available a number of resources developed by the academia, and local and state agencies for implementing various types of ITS in work zones. Such resources can be accessed through FHWA's Work Zone Mobility and Safety Program website<sup>2</sup>.

### 1.2.2 Massachusetts Department of Transportation (MassDOT)

In 2010, MassDOT developed the *Work Zone Transportation Management Procedures* to ensure compliance with the 2004 FHWA *Work Zone Safety and Mobility Rule 23 CFR 630 Subpart J*. The purpose of these procedures is to establish a clear and comprehensive process for evaluating and mitigating the impacts of construction work zones on the safety and mobility of both workers and the general public. The Procedures categorize projects into one of five impact levels using evaluation criteria, such as posted speed and impacts to the traffic among others. The highest impact levels (Levels 3, 4 and Significant Projects) as defined by MassDOT's *Work Zone Transportation Management Procedures* are required to develop an ITS Monitoring Plan (IMP) as part of the Traffic Management Plan (TMP) submission.

The level of effort that is required by the ITS Monitoring Plan (IMP) is dictated by the expected traffic impacts to normal operations on the roadway. In some instances the IMP may be as simple as the use of portable changeable message signs to reflect various shoulder and lane closure activity. For large traffic impact projects, designated by either Level 4 or "significant project status", MassDOT desires to use a full SWZ system to provide real-time information to the motorists travelling in and around the work zone.

In parallel to the Design Standards covered in this document, MassDOT has developed a Smart Work Zone Concepts of Operations (ConOps), which provides the high-level operational needs for the implementation of SWZs.

*Figure 3* shows the sequence of policy and guidance documentation, from general overarching work-zone framework to project-specific detailed SWZ design and operation.

<sup>2</sup> <http://www.ops.fhwa.dot.gov/wz/its/index.htm>.

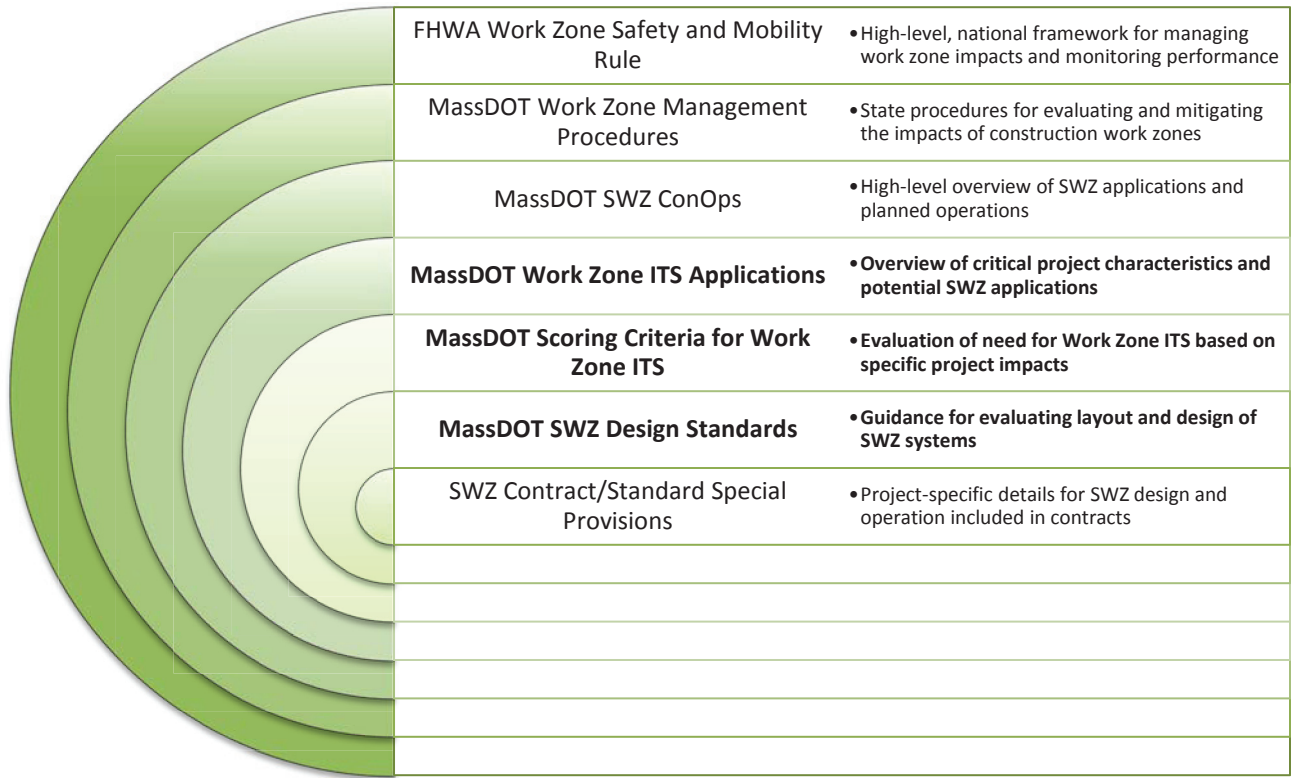

**Figure 3: Context for MassDOT SWZ Design Standards**

## 2. OVERVIEW OF SWZs

### 2.1 Typical Architecture

SWZs are portable combinations of equipment designed for flexible deployment in work zone environments. SWZs typically consist of four components:

- **Detection and surveillance equipment** that collect data and video near the work zone, and send them to the central processing system.
- **Central processing systems** that analyze, process, and store data. They also push messages to the public through signs and other dissemination outlets.
- **Dissemination outlets** on and off the road that make real-time information about work-zone conditions available to the public and MassDOT.
- **Ancillary systems** provide power to the equipment and communications between the components of the system.

Figure 4 shows a simplified SWZ system architecture and Section 4.2.2.4 describes SWZ components in more detail.

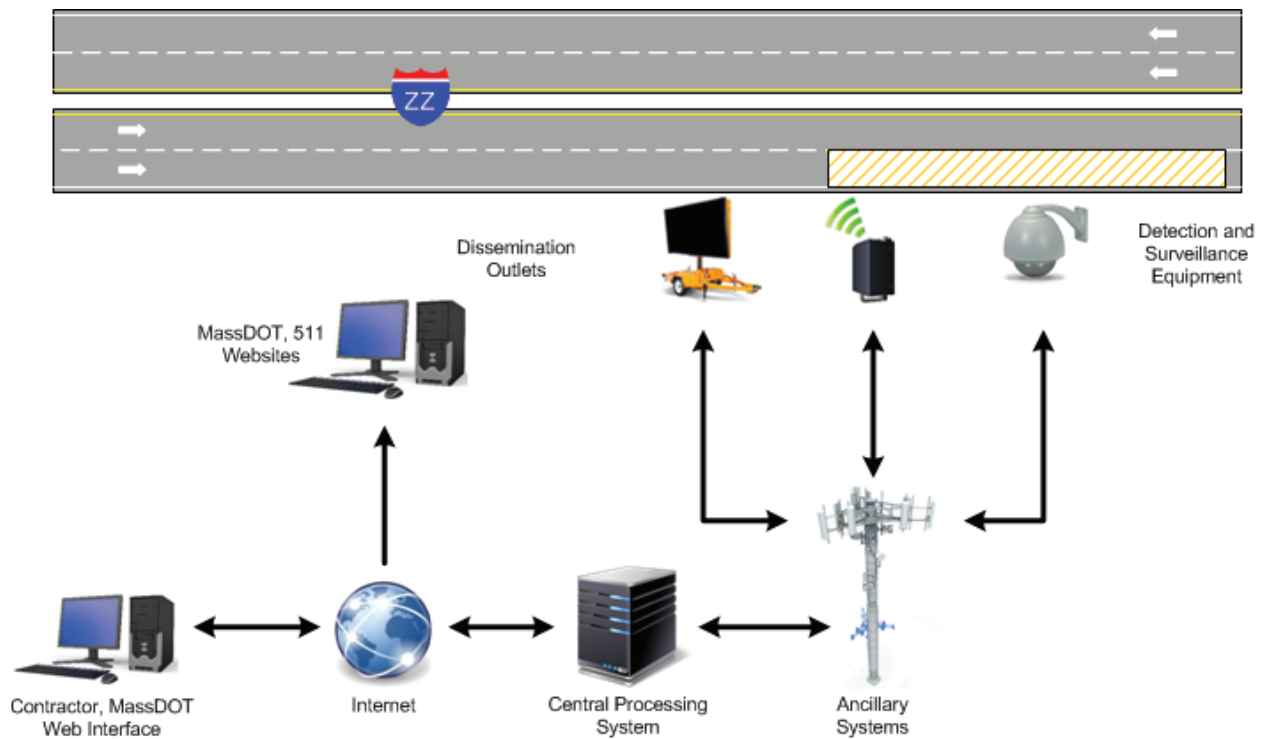

Figure 4: Typical Smart Work Zone Architecture

## 2.2 Assessment for Smart Work Zone Need

The SWZ systems displayed in *Figure 4* can be used for a variety of applications, depending on what an agency would like to achieve with them.

- Mobility applications are used when traffic is congested around a work zone and the agency would like to help motorists go around it or plan accordingly.
- Safety applications are used when hazards are present that could cause incidents and the agency wants motorists to be aware so they can slow down or go around.
- Planning and monitoring applications are used when an agency wants work zone data for internal operations purposes.

These applications are described in the section that follows.

### 2.2.1 SWZ Mobility Applications

Mobility applications are used when traffic backs up. “Mobility” refers to SWZ’s capability to ensure an efficient flow of traffic through the work zone, minimizing the congestion in the work zone through the reduction of traffic and/or the increase of the road capacity around the work zone. *Table 1* presents the SWZ mobility applications and Appendix A provides further detail on design standards.

**Table 1: SWZ Mobility Applications**

Application	Description	Benefits
<b>Driver Alerts</b>	Provision of simple messages notifying motorists of upcoming construction via electronic signs or other dissemination outlets.	<ul style="list-style-type: none"> <li>• Drivers can plan ahead if they are notified of construction before they begin their trips or early-on during trips, which avoids frustration.</li> <li>• Drivers can slow down and be aware when en-route, which reduces possibility of incidents.</li> </ul>
<b>Travel Time and Delay Estimation</b>	Provision of travel times and/or delay through the work zone via electronic signs or other dissemination outlets.	<ul style="list-style-type: none"> <li>• Drivers know how long they will wait so they feel less frustrated.</li> <li>• Drivers may change routes, which relieves congestion.</li> </ul>
<b>Alternate Route Advisory</b>	Provision of travel times through the work zone AND alternate routes via electronic signs or other dissemination outlets.	<ul style="list-style-type: none"> <li>• Drivers know how long they will wait so they feel less frustrated.</li> <li>• Drivers may change routes, which relieves congestion.</li> </ul>
<b>Dynamic Lane Merge</b>	Use of electronic signs to direct motorists to use all open lanes up to a metered merge point rather than merging early and causing upstream queuing.	<ul style="list-style-type: none"> <li>• Road capacity is increased and aggressive merge behavior is reduced.</li> </ul>

## 2.2.2 Safety Applications

Safety applications are used when hazards are present that could cause incidents. Safety refers to the SWZ's capability to minimize the number and severity of traffic-related incidents, injuries and fatalities, and asset damage in the work zone. Safety strategies are intended to maximize driver alertness and minimize surprise elements and sudden braking. *Table 2* presents the SWZ mobility applications and Appendix A provides further detail on design standards.

**Table 2: SWZ Safety Applications**

Application	Description	Benefits
<b>Congestion (Queue) Warning</b>	Warning to motorists upstream of the work zone to slow down when there is stopped or slow traffic ahead.	<ul style="list-style-type: none"> <li>• Drivers can decelerate safely and gradually, which reduces risk of collision.</li> <li>• Drivers may decide to change routes, which relieves congestion.</li> </ul>
<b>Excessive Speed Warning</b>	Warning to motorists when they are approaching the work zone at unsafe speeds	<ul style="list-style-type: none"> <li>• Drivers can decelerate safely and gradually, which reduces risk of collision.</li> </ul>
<b>Vehicle Warning</b>	Warning to motorists about construction vehicles merging into, entering, exiting, or crossing the roadway.	<ul style="list-style-type: none"> <li>• Drivers can react appropriately, such as slowing down or changing lanes.</li> </ul>
<b>Clearance Warning</b>	Warning to motorists about construction-related weight, height, or width restrictions.	<ul style="list-style-type: none"> <li>• Oversize vehicles change routes, which avoid incidents in the work zone.</li> </ul>
<b>Hazardous Condition Warning</b>	Warning to motorists about temporary hazardous situations such as flooding, standing water, low visibility, etc.	<ul style="list-style-type: none"> <li>• Drivers can slow down.</li> <li>• Drivers may decide to change routes, which relieves congestion and reduces risk of incident.</li> </ul>
<b>Intrusion Warning</b>	Warning to motorists and workers when an unauthorized vehicle has entered a restricted work area.	<ul style="list-style-type: none"> <li>• Drivers can react appropriately and exit the work zone.</li> <li>• Workers and managers are notified of the entry, allowing them to respond quickly.</li> </ul>
<b>Enforcement</b>	Identification of speeding drivers using License Plate Recognition technology in combination with other sensors.	<ul style="list-style-type: none"> <li>• Drivers are discouraged from speeding. *This is currently not legal for use in Massachusetts.</li> </ul>

## 2.2.3 Planning & Monitoring Applications

Planning and monitoring applications are used when agencies want to collect data about the work zone. SWZ data is used to develop performance reports, allocate enforcement patrols, refine guidance for allowable working hours, and ultimately deliver capital improvements more safely and efficiently. *Table 3* describes some applications and their benefits.

**Table 3: SWZ Planning & Monitoring Applications**

<b>Application</b>	<b>Description</b>	<b>Benefits</b>
<b>Video Surveillance</b>	Provision of real-time video, preferably online, for remote monitoring.	<ul style="list-style-type: none"> <li>• Can be used to look at worksites from offsite to confirm issues and determine if interventions are required.</li> </ul>
<b>Traffic Data Collection</b>	Collection of average speeds and volume data for performance measurement.	<ul style="list-style-type: none"> <li>• Used for internal performance measurements and reporting to FHWA.</li> <li>• Used to estimate capacity of the work zone.</li> <li>• Helps understand traffic flow to inform work zone policy and planning for future projects.</li> </ul>
<b>Travel Time Data Collection</b>	Collection of travel times and estimation of delay through the work zone for performance measurement.	<ul style="list-style-type: none"> <li>• Used for internal performance measurements and reporting to FHWA</li> <li>• Used to monitor traffic levels and determine if interventions are required.</li> <li>• Helps understand traffic flow to inform work zone policy and planning for future projects.</li> </ul>

#### **2.2.4 Work Zone ITS Application Characteristics**

To help assist the designer with the evaluation of the appropriate SWZ needs, MassDOT provides a matrix that outlines the critical project characteristics for use in selecting potential portable work zone ITS applications. The matrix is provided in **Appendix A, Exhibit 1**.



## 2.3 SWZ Components

SWZs are comprised of the four components described in section 2.1 -- detection and surveillance equipment, central processing systems, dissemination outlets, and ancillary systems. Within each of these categories, the specific technologies used depend on which applications the agency or contractor would like to provide. In some cases, the same set of technology can be used to provide several functions. The following section describes SWZ system components in more detail and shows which components are necessary to deploy the applications described in the previous section.

### 2.3.1 Detection and Surveillance Equipment

Detection and surveillance equipment are installed in the field to collect information about the work zone environment. *Table 4* presents common technologies used in SWZs with the data that they can collect. The detection and surveillance equipment are the “eyes and ears” of the smart work zone system. They must be placed intentionally, calibrated carefully, and operated reliably so that they collect accurate data for input to the processing systems.

**Table 4: Detection and Surveillance Equipment Used in SWZs**

Detection Equipment	Description	Data That Can Be Collected
<b>Traffic Sensors</b> <sup>3</sup>	Non-intrusive devices placed on or around the roadway to detect vehicles passing.	Volume, Speed*, Occupancy*, Classification*, Weight*, Motion*
<b>Video cameras</b>	Portable pan-tilt-zoom video cameras mounted temporarily on fixed structure or trailers to view an area of interest in real-time.	Volume, Images, Incidents, Motion, Occupancy, Speed
<b>Short-Range Transmitter Receiver Systems</b> <sup>4</sup>	Receivers mounted near the road that detect compatible transmitters in vehicles passing by.	Speed, Travel Time, Identification of Authorized Construction Vehicles (e.g. for entry)
<b>Vehicle Probes</b>	Instrumented vehicles on the roadway that provide information about location and speeds, usually through Global Positioning System (GPS).	Speed, Travel Time
<b>Environmental</b>	Non-intrusive sensors on or near the road designed to detect temperature, humidity, precipitation, and/or other environmental data.	Weather data, Road conditions

\*Availability depends on specific technology chosen

<sup>3</sup> There are many different technologies, including Radar, Microwave, Pneumatic Road Tubes, Infrared, Acoustical, Ultrasonic, Magnetic, and Piezo-electric. Radar and Microwave are the most common at MassDOT.

<sup>4</sup> There are many different technologies. Radio Frequency Identification (RFID) and Bluetooth technology are the most common at MassDOT.

Radar and microwave are the most commonly used detection technologies at MassDOT. *Figure 5* shows examples of each.



**Figure 5: Portable Traffic Sensor (PTS) (microwave) and an iCone® (radar)**

*Figure 6* presents examples of Portable Video Cameras (PVC) commonly used in SWZ as surveillance devices.



**Figure 6: Portable Video Camera (PVC)**

*Table 5* shows the data requirements and commonly used detection/surveillance equipment for each application presented in this document.

Table 5: Data Requirements in SWZ Applications

		Availability of Required Data from Detection/Surveillance Equipment					
	Application	Data Requirements	Traffic Sensors	Video cameras	Short-Range Transmitter Receiver Systems	Vehicle Probes	Environmental Sensors
Mobility Applications	Driver Alerts	• No Data	-	-	-	-	-
	Travel Time and Delay Estimation	• Travel Time or Speed	✓	S	✓	S	-
	Alternate Route Advisory	• Travel Time or Speed	✓	S	✓	S	-
	Dynamic Lane Merge	• Speed • Occupancy	✓	S	✓	-	-
Safety Applications	Congestion (Queue) Warning	• Speed • Occupancy	✓	S	✓	-	-
	Excessive Speed Warning	• Speed	✓	S	-	-	-
	Vehicle Warning	• Motion or Identification	✓	S	✓	-	-
	Clearance Warning	• Classification • Weight • Motion	✓	S	-	-	-
	Hazardous Condition Warning	• Weather • Road Conditions	-	✓	-	-	✓
	Intrusion Warning	• Motion or Identification	✓	S	✓	-	-
	Enforcement	• Speed • License Plate Recognition or Photo	✓	✓	-	-	-
Planning & Monitoring Applications	Video Surveillance	• Video	-	✓	-	-	-
	Traffic Data Collection	• Speed, Volume, Occupancy, Classification, Queues	✓	S	✓	S	-
	Travel Time Data Collection	• Travel Time	S	S	✓	✓	-

✓ = All or most equipment provide required data; most commonly used equipment.

S = Some systems provide required data; special central processing analytics are required.

### 2.3.2 Central Processing System

The central processing system is a collection of computers that is used to control and monitor field devices. It hosts the software for processing and storing data. It is typically located off-site even if some basic processing is carried out onsite within devices.

The central processing system is the “brain” behind the SWZ system and take substantial time, effort, and expense to develop. The central system requires quality input data from the detection and surveillance equipment in order to develop quality output data that will be disseminated to the public.

### 2.3.3 Information Dissemination System

Dissemination outlets are used to push messages to the public and MassDOT. They are the “mouth” of the SWZ system. *Table 6* shows the most common devices and systems, both on-site and off-site. Off-site dissemination systems are designed to push messages to drivers before they depart so that they can plan accordingly.

**Table 6: Information Dissemination Devices/Systems Used in SWZs**

Location	Device/System	Description
On-site	<b>Portable Changeable Message Sign (PCMS)</b>	Electronic signs used to display traffic conditions, travel times, incident information, and advisory messages.
	<b>Hybrid Message Sign (HMS)</b>	Static signs with a fixed legend and two-character electronic insert for the provision of travel times.
	<b>Highway Advisory Radio (HAR)</b>	Broadcasting of travel information in low band, AM frequencies, typically used in conjunction with a static signs or PCMS that tells drivers which frequency to turn to.
	<b>Audible alarms</b>	Acoustic alerts as a complement of visual devices for specific needs (e.g. work zone intrusion).
Off-site	<b>Websites and Smartphone Applications</b>	Publication of travel information on MassDOT, 511, and third-party websites/Smartphone Apps for pre-trip planning purposes. They may provide detailed information on speeds, delays, congestion alternate routes, PCMS messages, video images, and contractor schedules.
	<b>SMS text messaging systems</b>	Alerts and updates on traffic conditions sent to mobile phones of drivers and construction and MassDOT personnel.
	<b>511 Telephone System</b>	Travel information may be relayed to Mass 511 operator to be consulted by drivers.



Figure 7 shows two examples of a dissemination device used by MassDOT. They must be located intentionally and operated reliably, as they are the means through which motorists will view the system. If they do not work reliably, the motorists quickly lose interest or begin to not trust the information displayed.

Figure 7: Portable Changeable Message Sign (PCMS) and Hybrid Message Sign (HMS)

Table 7 shows the commonly used information dissemination equipment/systems for each application presented in this document.

Table 7: Dissemination Devices in SWZ Applications

Applicability of Dissemination Devices to Applications								
	Application	PCMS	HMS	HAR	Audible Alarms	Websites and Smartphone Applications	SMS Alerts	511
Mobility Applications	Driver Alerts	✓	S	S	-	-	-	-
	Travel Time and Delay Estimation	✓	✓	S	-	✓	✓	✓
	Alternate Route Advisory	✓	✓	S	-	✓	✓	✓
	Dynamic Lane Merge (Early Merge or Late Merge Options)	✓	-	S	-	-	-	-
Safety Applications	Congestion (Queue) Warning	✓	-	S	-	✓	✓	✓
	Excessive Speed Warning	✓	✓	-	-	-	-	-
	Vehicle Warning	✓	-	-	✓	-	-	-
	Clearance Warning	✓	-	-	✓	S	S	S
	Hazardous Condition Warning	✓	-	S	-	✓	✓	S

Applicability of Dissemination Devices to Applications							
Application	PCMS	HMS	HAR	Audible Alarms	Websites and Smartphone Applications	SMS Alerts	511
Intrusion Warning	✓	-	-	✓	-	✓*	-
Enforcement	-	✓	S	-	-	✓*	-
Planning & Monitoring Applications	Video Surveillance	-	-	-	✓*	-	-
	Traffic Data Collection	✓	✓	S	-	✓*	-
	Travel Time Data Collection	✓	✓	S	-	✓*	S

\* Internal only for MassDOT Staff

✓ = Applicable in all or most cases; most commonly used equipment.

S = Applicable in some cases.

### 2.3.4 Ancillary Support Systems: Communications and power

Ancillary support systems like communications and power are the “backbone” for SWZs. Wireless communications is commonly used to exchange information between detection devices, the central processing system, and dissemination systems. On rare occasions, hard wired communications may also be used if physical connections are available in the work zone area.

Battery and solar power are typically the power choices for SWZ. As with communications, hard-wired power may be used if available in the area.



### 3. APPLICATION TO MASSDOT PROJECTS

MassDOT deploys SWZs for the benefit of motorists and for internal data collection purposes. SWZs can benefit any construction site, but it is not necessary or practical to deploy all SWZ functions on all jobs. To assist the designer in determining SWZ applicability for a particular project, MassDOT has provided a *Smart Work Zone Scoring Matrix* found in **Appendix A, Exhibit 2**. The following section suggests strategies for determining what types of functions to include in SWZ deployments in Massachusetts.

The *MassDOT Work Zone Transportation Management Procedures* establish that projects categorized at impact Levels 3 or 4, or Significant Project Status shall include an ITS Monitoring Plan (IMP) as part of the 75%, 100%, PS&E deliverables. The IMP can also be requested discretionally by the State Traffic Engineer for work zones outside of those levels. Suggested SWZ functions for each impact level are shown in the following table.

**Table 8: SWZ Functions Based on Project Impact Levels**

Project Impact	Extent of ITS Coverage	Mobility Functions		Safety Functions	Planning & Monitoring Functions			
		Travel Time and Delay Notifications	Alternate Route Advisory	Congestion Warning	Video Surveillance	Site Traffic Data	Approach Traffic Data	Capacity Estimate
<b>Level 1 &amp; 2</b>	Work site	O	O	-	O	O	-	O
<b>Level 3</b>	Work site & vicinity	✓	✓	O	✓	✓	O	✓
<b>Level 4 &amp; Significant Projects</b>	Work site, vicinity & approaches	✓	✓	✓	✓	✓	✓	✓

✓ = Recommended for all, O = Recommended for some cases

In addition to the fixed suggestions for each type of project, additional SWZ equipment may be helpful if the work site has special characteristics or hazards that make it more susceptible to incidents. These are described in Table 9.

**Table 9: Optional SWZ Functions Based on Hazards Present**

Project Characteristics	Relevant SWZ Functions
There is a need to post information not easily conveyed by static signs, such as more than one message at the time or changeable messages according to time or traffic conditions.	<b>Driver Alerts</b>
Work zone must be established when expected traffic volumes will exceed MassDOT current average work zone capacity.	<b>Dynamic Lane Merge</b>
Any of the following situations within one mile downstream and/or upstream of the work zone: <ul style="list-style-type: none"> <li>o Queue formation on tight curves or hills</li> <li>o Absence of buffer spaces and/or clear zones</li> <li>o Interaction with construction workers or police</li> <li>o Locations with speeding history</li> </ul>	<b>Excessive Speed Warning</b>

Project Characteristics	Relevant SWZ Functions
More than five (5) construction vehicle merging, entering, exiting or crossing maneuvers per hour.	<b>Vehicle Warning</b>
Work zone's vertical and horizontal clearance, and weight limit are lower than the largest vehicle allowed in the original road. Also, when oversized vehicles are allowed to travel through the work zone.	<b>Clearance Warning</b>
<p>The following conditions are expected:</p> <ul style="list-style-type: none"> <li>o Flooding or standing water</li> <li>o Low visibility (fog, solar or smoke)</li> <li>o Slippery or rough conditions</li> <li>o Hazards on roadway (falling rock, debris)</li> </ul>	<b>Hazardous Condition Warning</b>
Construction traffic exits and entrances are difficult to identify, making other vehicles inadvertently follow trucks off the road. Also, where delineation between the road and restricted areas is not clear, or where protection buffers are not possible.	<b>Intrusion Warning</b>
More than 0.9 crashes per million vehicle miles traveled in the road segment between one mile upstream and one mile downstream from the work zone during the previous year.	<b>Enforcement</b>

## 4. LAYOUT & DESIGN GUIDELINES

The first step of SWZ design is determining the desired applications for the work zone and the equipment to be deployed, based on Sections 2 & 3. Then the layout of equipment can be designed according to the following steps:

### 4.1 Layout Guidelines

1. Map the location of the SWZ and vicinity.
2. Identify the following locations:
  - (a) Start of the work zone.
  - (b) End of the work zone.
  - (c) The location of merge/lane drop for closure.
  - (d) All approaches within 0.5 miles of the work activity.
  - (e) The upstream decision points nearest to the work activity (i.e. the closest viable locations where drivers could exit the highway and take a suitable alternate route before reaching the work zone).
  - (f) For Level 4 or Significant projects located on major highways or interstates, also identify any upstream intersections/interchanges with other major highways that could offer alternate routes.
  - (g) 1 point upstream of the bottleneck where traffic should be stable during most operating hours.
  - (h) 1 point downstream of the bottleneck where traffic should be stable during most operating hours.
3. Place required detection and surveillance equipment in the locations identified above as presented in *Table 10*.
4. Place PCMS as follows at the locations identified above, based on the functions to be included in the SWZ as presented in *Table 10*.









Table 10: Equipment Location

Device	Level 1 & 2	Level 3	Level 4 & Significant Project Status
Traffic detectors	(c)*	(c)(g)(h)	(c)(d)(g)(h)
Short-range receivers for travel time measurement	(a)*(b)*	(a)(b)(d)(e)	(a)(b)(d)(e)(f)
Cameras	(c)*	(a)(b)(c)(d)*	(a)(b)(c)(d)*(e)*(f)
Special detectors (e.g. hazardous conditions, intrusion warning)	Project-specific	Project-specific	Project-specific
PCMS/HMS	(a)*(d)*	(a)(d)(e)(g)	(a)(d)(e)(f)(g)

\* Optional

Equipment should be placed according to its operating requirements and capabilities. In small work zones, some equipment (such as video) may be able to cover multiple locations. Additional design guidelines are provided in Section 4.2.

A sample diagram of a layout for Level 3, Level 4 and Significant Status projects are shown in *Figure 9* and *Figure 10*. These diagrams are intended as guidelines, so dimensions are not drawn to scale. Engineering judgment is required to customize the system to a specific project.

 <p>Work Zone</p>	 <p>PVMS or HMS</p>
 <p>Detection Equipment</p>	 <p>HMS message</p>
 <p>Video/Photo Camera</p>	 <p>PVMS message</p>
 <p>Alarm</p>	 <p>PVMS Phase Change</p>
 <p>Hazardous Condition (Flooding)</p>	

**Note:** Portable Variable Message Sign (PVMS) is synonymous with Portable Changeable Message Sign (PCMS)

**Figure 8: Key for Layout Diagrams**

# Project Level 3

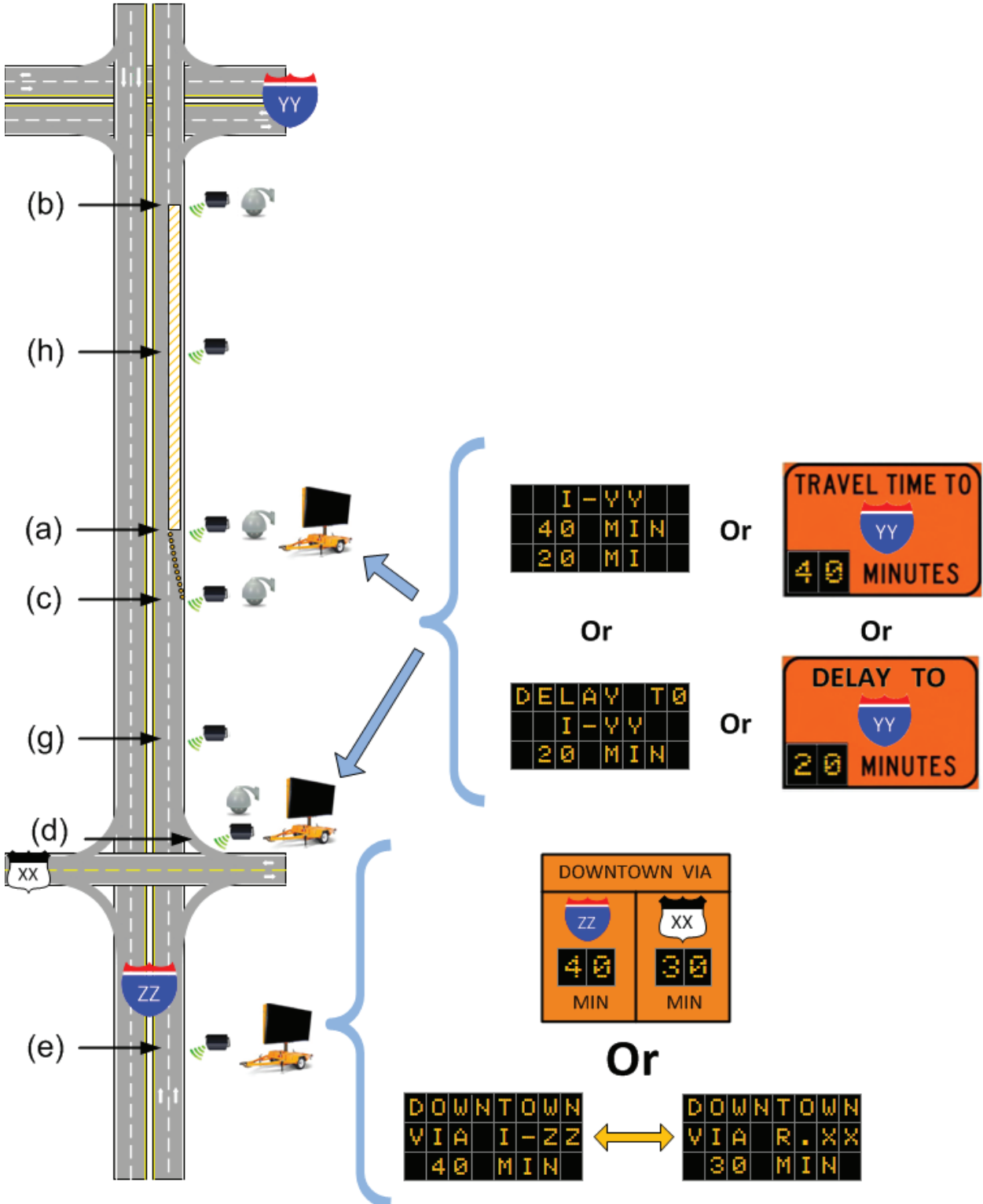

Figure 9: Typical SWZ setup for a Project Level 3

# Project Level 4 or Significant Project Status

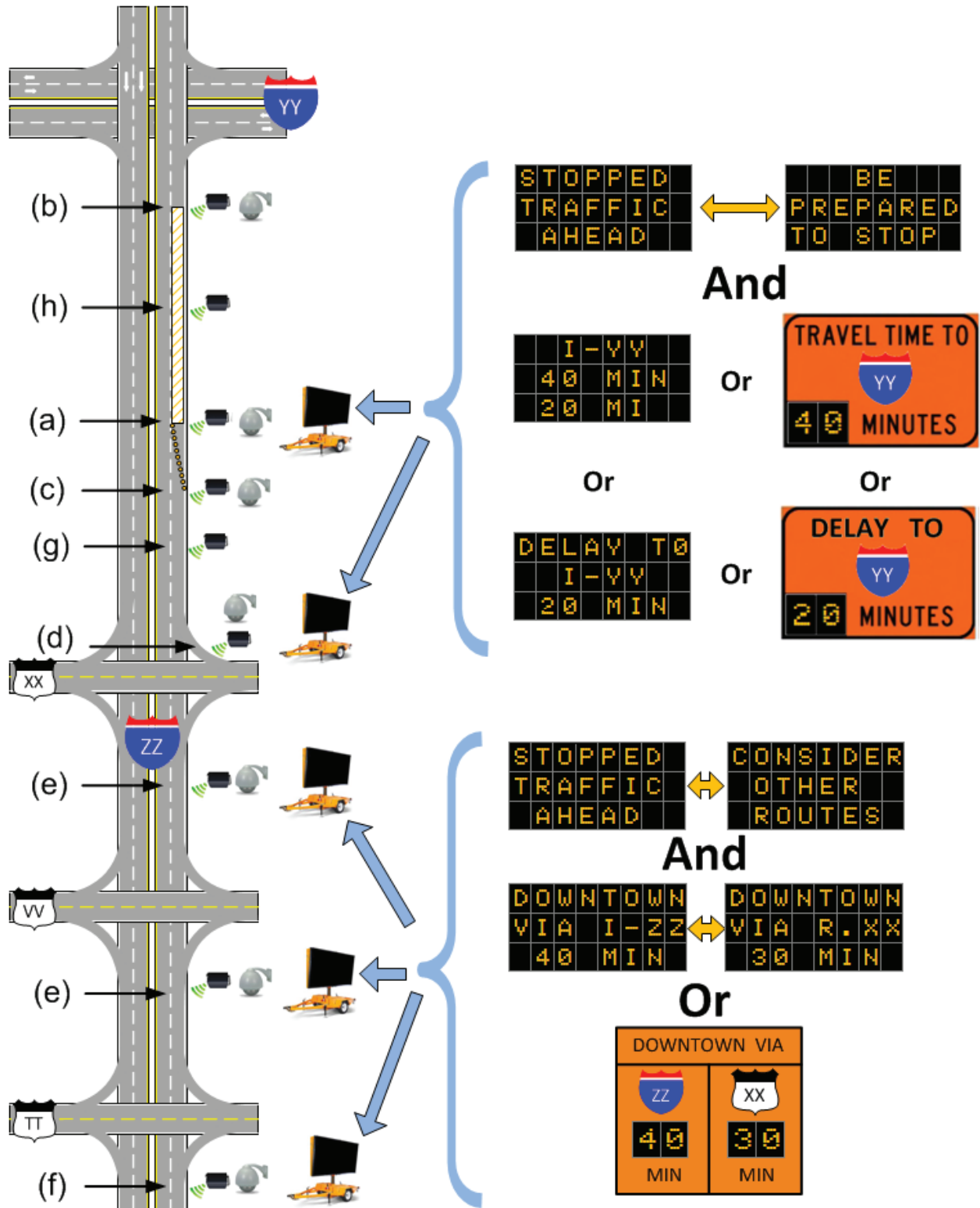

Figure 10: Typical SWZ setup for a Project Level 4 or Significant Project Status



## **4.2 Design Guidelines**

### **4.2.1 General design guidelines**

- Equipment should be located in accordance with manufacturers' guidance.
- Equipment must be placed outside the clear zone unless approved by MassDOT.
- Equipment should be protected by physical barriers (such as guardrails) where it is practical.
- Equipment should be placed in locations that are easy to move and access if necessary (e.g. near the end of guardrail).
- Equipment should not be placed where sight lines are blocked by other static signing on the roadside
- Equipment should be placed so as to not block existing static sign visibility
- Care should be taken to select locations for equipment that will provide adequate sunlight exposure to maximize solar power coverage.

### **4.2.2 Detection and Surveillance Equipment**

- Place portable cameras in locations that provide good coverage of the location of interest, taking care to avoid blind spots, seasonal sun-blindness, and visual obstructions (bridges, overpasses, viaducts, foliage, buildings, etc.).
- When possible, place cameras on the outside of a highway curve because it provides better visual coverage.
- Consider travel patterns through and around the work zone when placing detectors, particularly those used for travel time. The presence of high occupancy vehicle (HOV) lanes and exits within the work zone will influence what drivers want to see on signs. For example, motorists may need differentiated data for HOV lanes or travel time to a popular exit rather than another end point. The presence of such features may also affect the data that is collected on the devices (e.g. faster traffic in an HOV lane or slower traffic in an exit lane may skew results). Sometimes such judgments can be made by reviewing the site; other times it may require additional traffic data.
- Place detectors in locations that maximize the coverage area and accuracy of collected data. The accuracy of detection equipment may be compromised by factors such as:
  - Orientation, distance, and height of the device with respect to the traffic
  - Spacing between devices
  - Extreme congestion with stop-and-go traffic conditions
  - Presence of obstructing structures such as bridges, median barriers, and signs

### **4.2.3 Dissemination Outlets**

- Dissemination devices, such as PCMS and HMS, should not replace or block required static signs as stipulated by MUTCD and MassDOT regulations.

- MassDOT normally requires a minimum spacing between signs (static and electronic). If minimum spaces are not possible, it may be necessary to strategically co-locate signs or use one sign for multiple purposes.
- MassDOT will work with the contractor to address questions surrounding the field placement of SWZ equipment.
- PCMS and HMS should be placed in locations where motorists would find them useful, typically before major decision points (e.g. exits or intersections), with enough advance warning that motorists can safely change course. In some cases, this will require engineering judgment in lieu of detailed instructions.
- Review the location of the PCMS and HMS for conditions in the field, such as:
  - Shoulder (and clear zone)
  - Nature of embankment
  - Nature of the median
  - Line of sight
  - Ground slope
  - Avoiding impacting wetlands
  - Sunlight exposure for solar panels
  - Existing roadway signs and guardrail
  - Accessibility for maintenance

## 5. REFERENCES

### 5.1 Federal/State Laws and Code

- 23 CFR 630 Subpart J-- Work Zone Safety and Mobility Rule, FHWA  
[http://www.ops.fhwa.dot.gov/wz/resources/final\\_rule.htm](http://www.ops.fhwa.dot.gov/wz/resources/final_rule.htm)
- “Final Rule on Work Zone Safety and Mobility,” Federal Highway Administration (FHWA), Effective Date October 12, 2007  
[http://www.ops.fhwa.dot.gov/wz/resources/final\\_rule.htm](http://www.ops.fhwa.dot.gov/wz/resources/final_rule.htm)
- Manual on Uniform Traffic Control Devices (MUTCD), FHWA  
<http://mutcd.fhwa.dot.gov/>
- SAFETEA-LU section 1201, FHWA  
<http://www.fhwa.dot.gov/safetealu/factsheets/realtimesmi.htm>
- Best Practices in Project Delivery Management. NCHRP Domestic Scan Team Report 07-01, Project 20-68A. TRB, National Research Council, Washington, DC. October 2009.  
[http://onlinepubs.trb.org/onlinepubs/nchrp/docs/nchrp20-68a\\_07-01.pdf](http://onlinepubs.trb.org/onlinepubs/nchrp/docs/nchrp20-68a_07-01.pdf)

### 5.2 Design Guidance

- Work Zone Intelligent Transportation Systems Implementation Guide (FHWA) January 2014  
<http://www.ops.fhwa.dot.gov/publications/fhwahop14008/>
- ITS Safety and Mobility Solutions--Improving Travel Through America's Work Zones,  
<http://www.atssa.com/galleries/defaultile/2008July21 ITS Safety and Mobility.pdf>
- MassHighway Standard Details and Drawings for the Development of Temporary Traffic Control Plans, MassDOT  
<http://www.massdot.state.ma.us/portals/8/docs/flaggers/tcp.pdf>

- AASHTO Guidelines For Traffic Data Program, USDOT  
[https://bookstore.transportation.org/item\\_details.aspx?id=1392](https://bookstore.transportation.org/item_details.aspx?id=1392)









### 5.3 Supplemental Documents

- ITS in Work Zones, FHWA [www.ops.fhwa.dot.gov/wz/its/](http://www.ops.fhwa.dot.gov/wz/its/)
- Work Zone Analysis Series, FHWA  
[http://ops.fhwa.dot.gov/wz/traffic\\_analysis/techresources.htm](http://ops.fhwa.dot.gov/wz/traffic_analysis/techresources.htm)
- Work Zone Performance Measures Pilot Test, FHWA  
<http://www.ops.fhwa.dot.gov/wz/resources/publications/fhwahop11022/fhwahop11022.pdf>
- A Primer On Work Zone Safety And Mobility Performance Measurement, FHWA  
<http://www.ops.fhwa.dot.gov/wz/resources/publications/fhwahop11033/fhwahop11033.pdf>
- Work Zone Operations Best Practices Guidebook, FHWA  
<http://www.ops.fhwa.dot.gov/wz/practices/best/bestpractices.htm>
- Minnesota IWZ Toolbox, FHWA  
<http://wwwcf.fhwa.dot.gov/exit.cfm?link=http://www.dot.state.mn.us/trafficeng/workzone/iwz/MN-IWZToolbox.pdf>
- In Case Of Fire--Technology Helps Clear A Path For First Responders  
[http://www.ops.fhwa.dot.gov/wz/resources/news/wznews\\_detail.asp?ID=479](http://www.ops.fhwa.dot.gov/wz/resources/news/wznews_detail.asp?ID=479)

## APPENDIX A: TYPICAL SWZ SETUPS FOR SAFETY AND MOBILITY APPLICATIONS

The following layout diagrams are intended to provide guidelines that should lead to practical solutions by the designer. Dimensions are not drawn to scale, and the location and quantity of devices are merely conceptual, so engineering judgment is required to customize the system to a specific project. The Massachusetts *ITS Deployment and Design Guide*, and other MassDOT and FHWA documentation provide guidance on device locations, but the designer should always keep in mind that the ITS equipment usually extends beyond the limits of the work zone.

### Key for Layout Diagrams

 <p>Work Zone</p>	 <p>PVMS or HMS</p>
 <p>Detection Equipment</p>	 <p>HMS message</p>
 <p>Video/Photo Camera</p>	 <p>PVMS message</p>
 <p>Alarm</p>	 <p>PVMS Phase Change</p>
 <p>Hazardous Condition (Flooding)</p>	

**Note:** Portable Variable Message Sign (PVMS) is synonymous with Portable Changeable Message Sign (PCMS)

# Driver Alerts

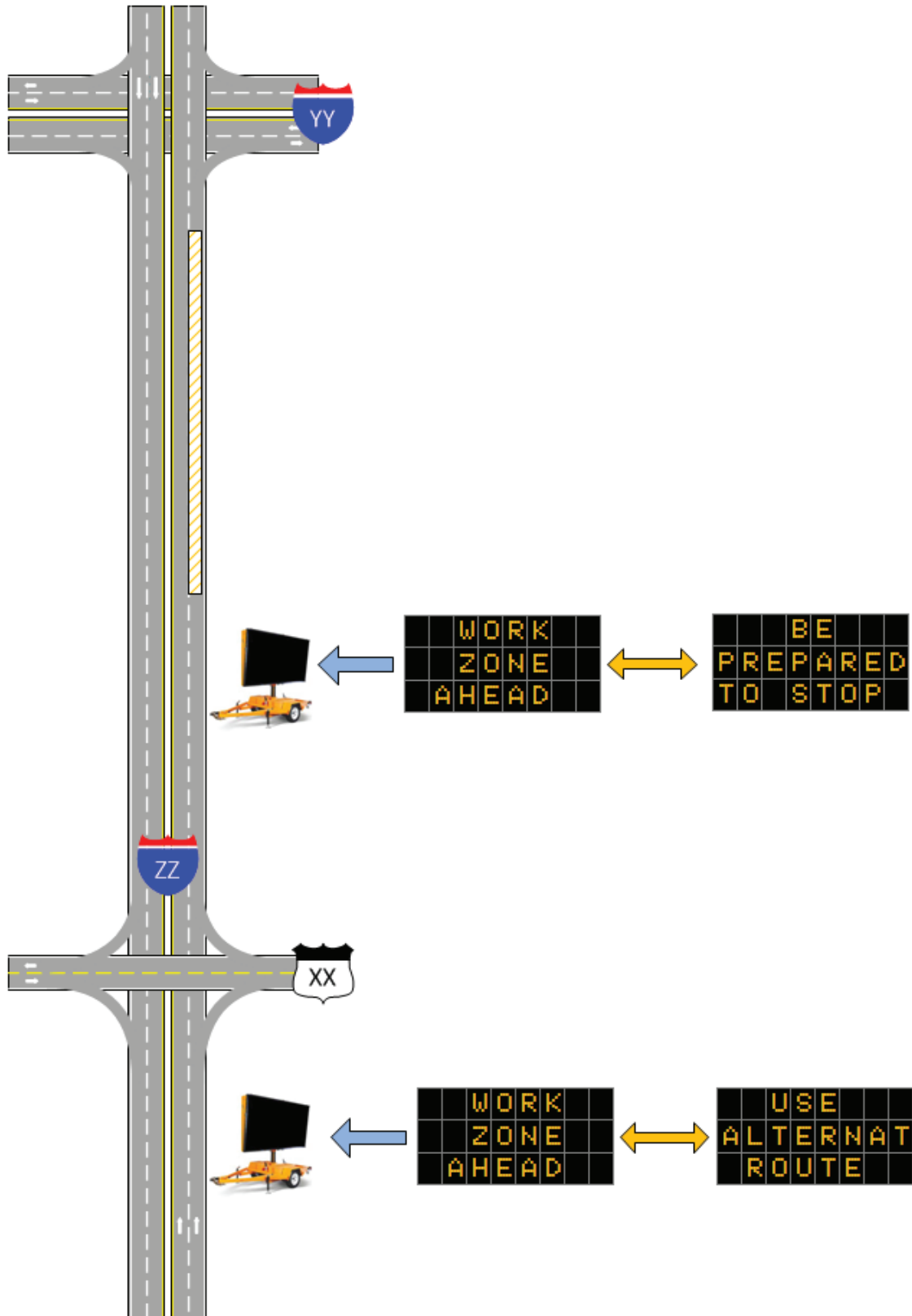

# Travel Time and Delay Estimation

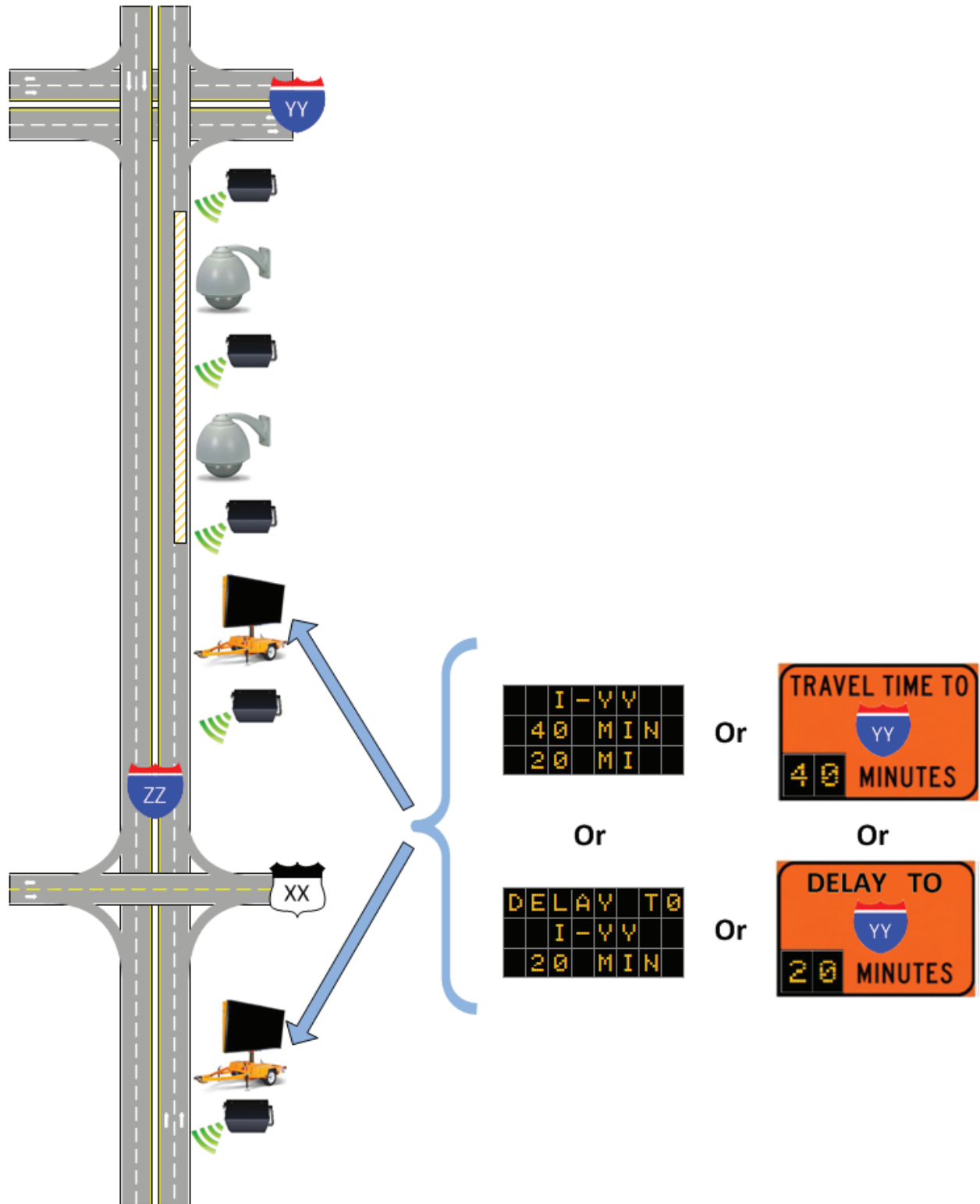



# Alternate Route Advisory

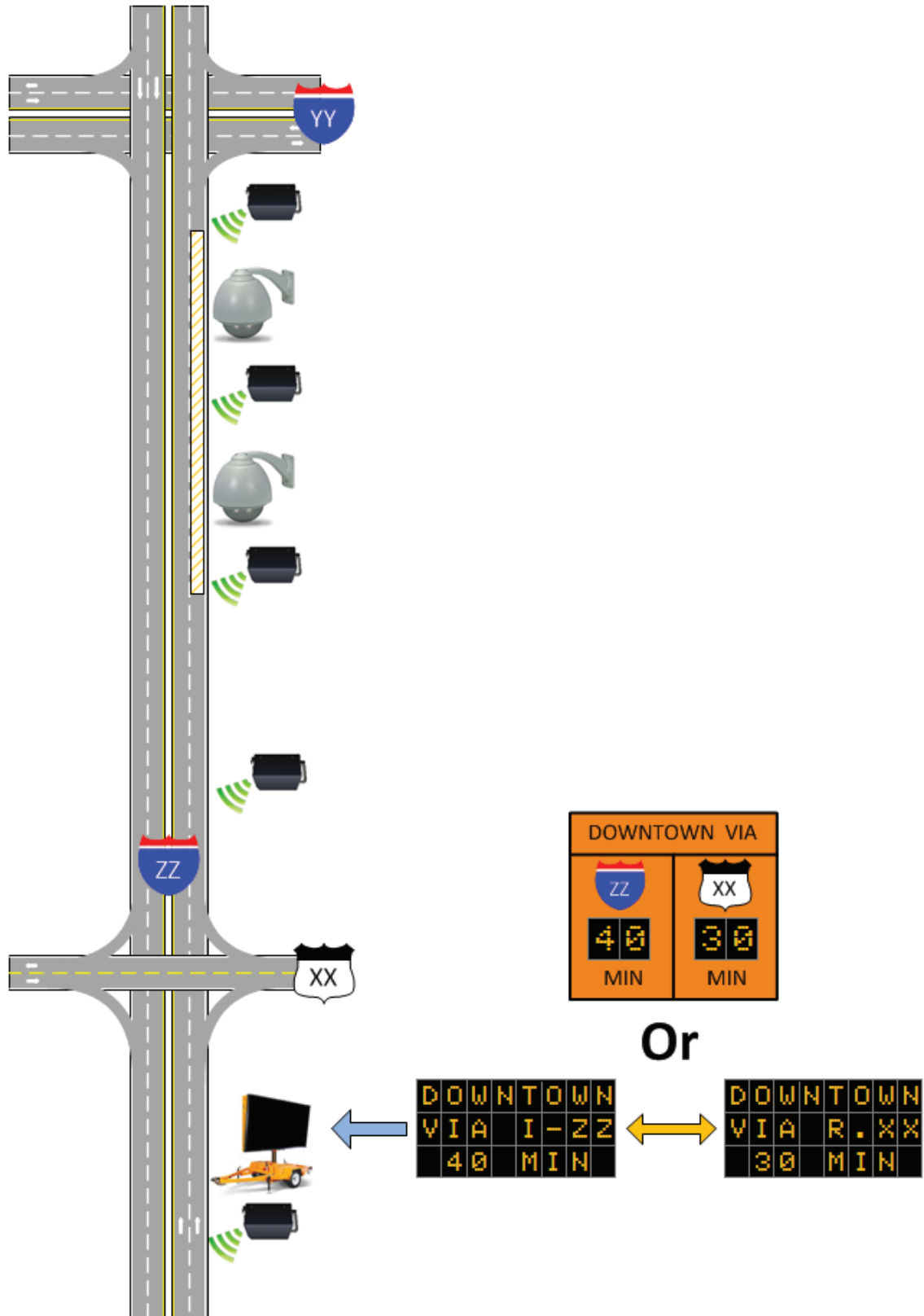

# Congestion Warning

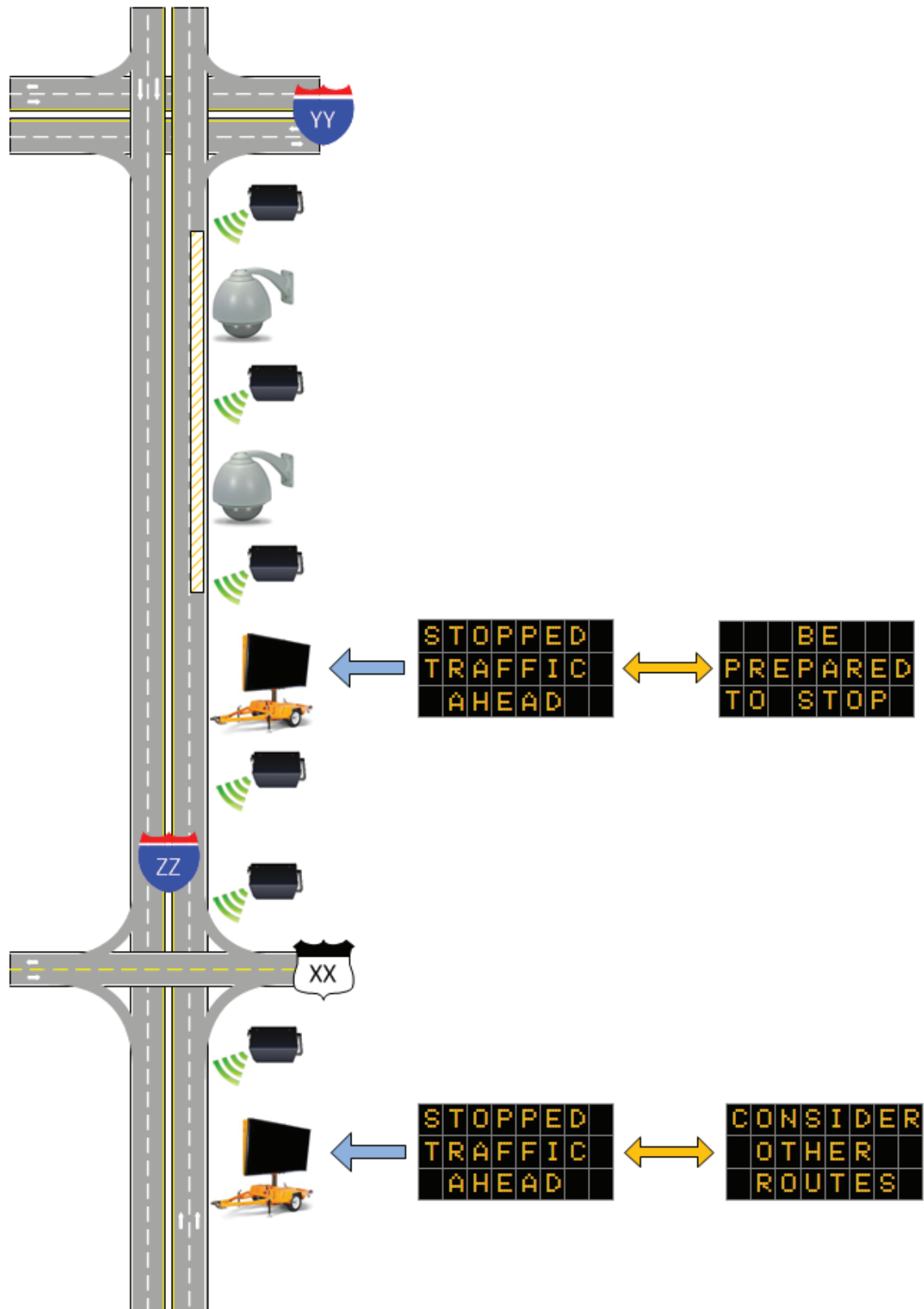

# Dynamic Lane Merge

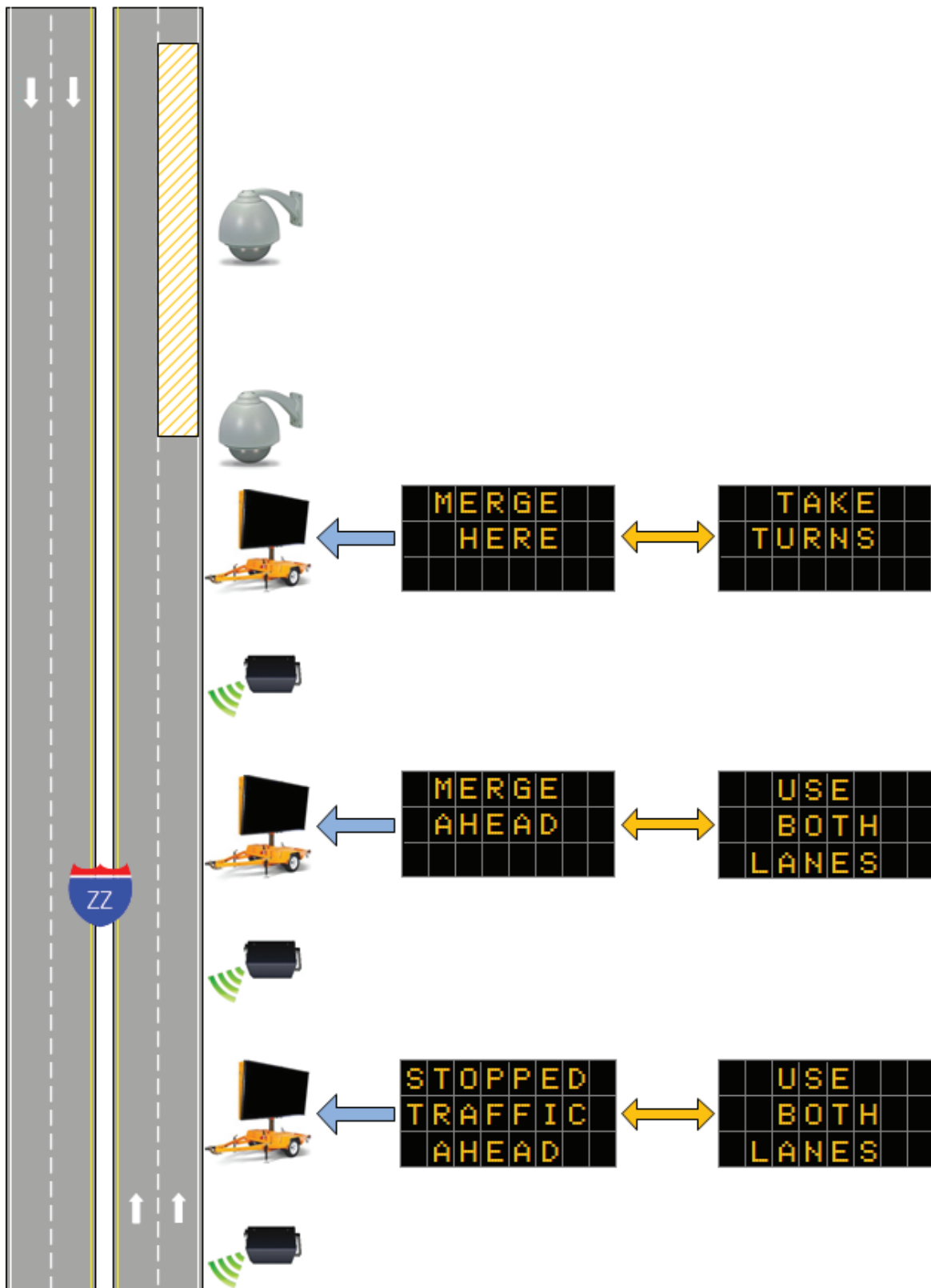

# Excessive Speed Warning

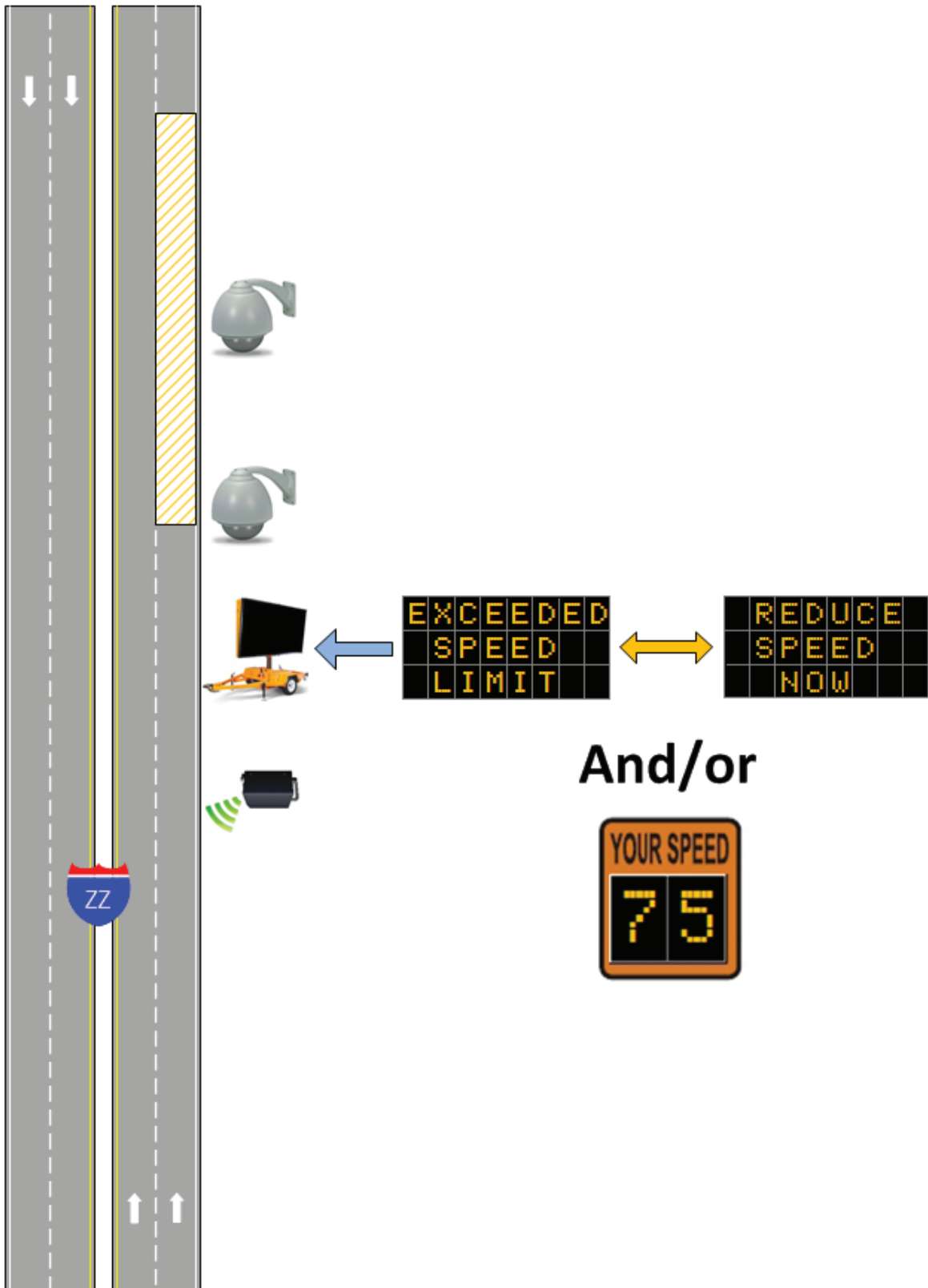

# Vehicle Warning

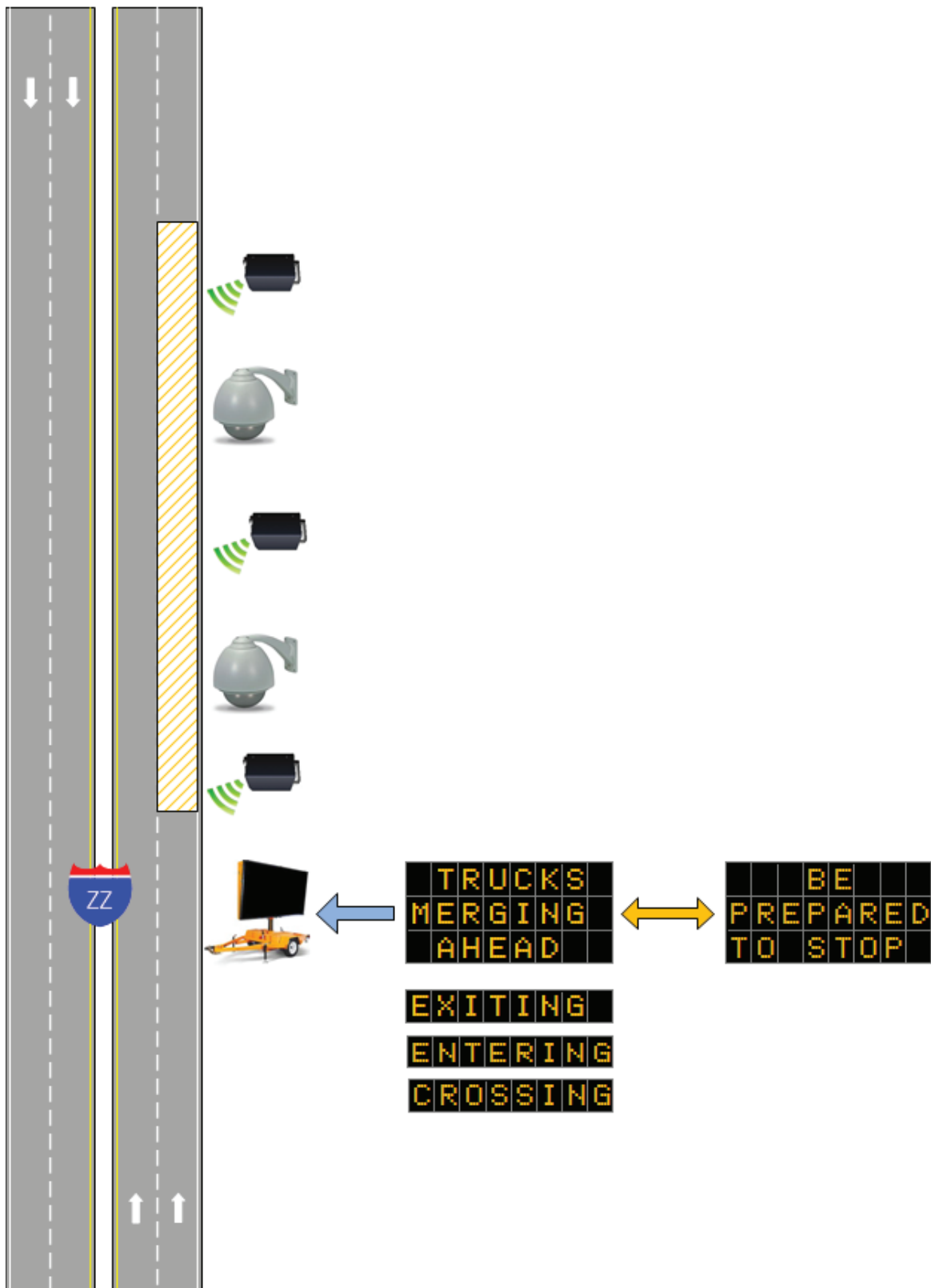

# Clearance Warning

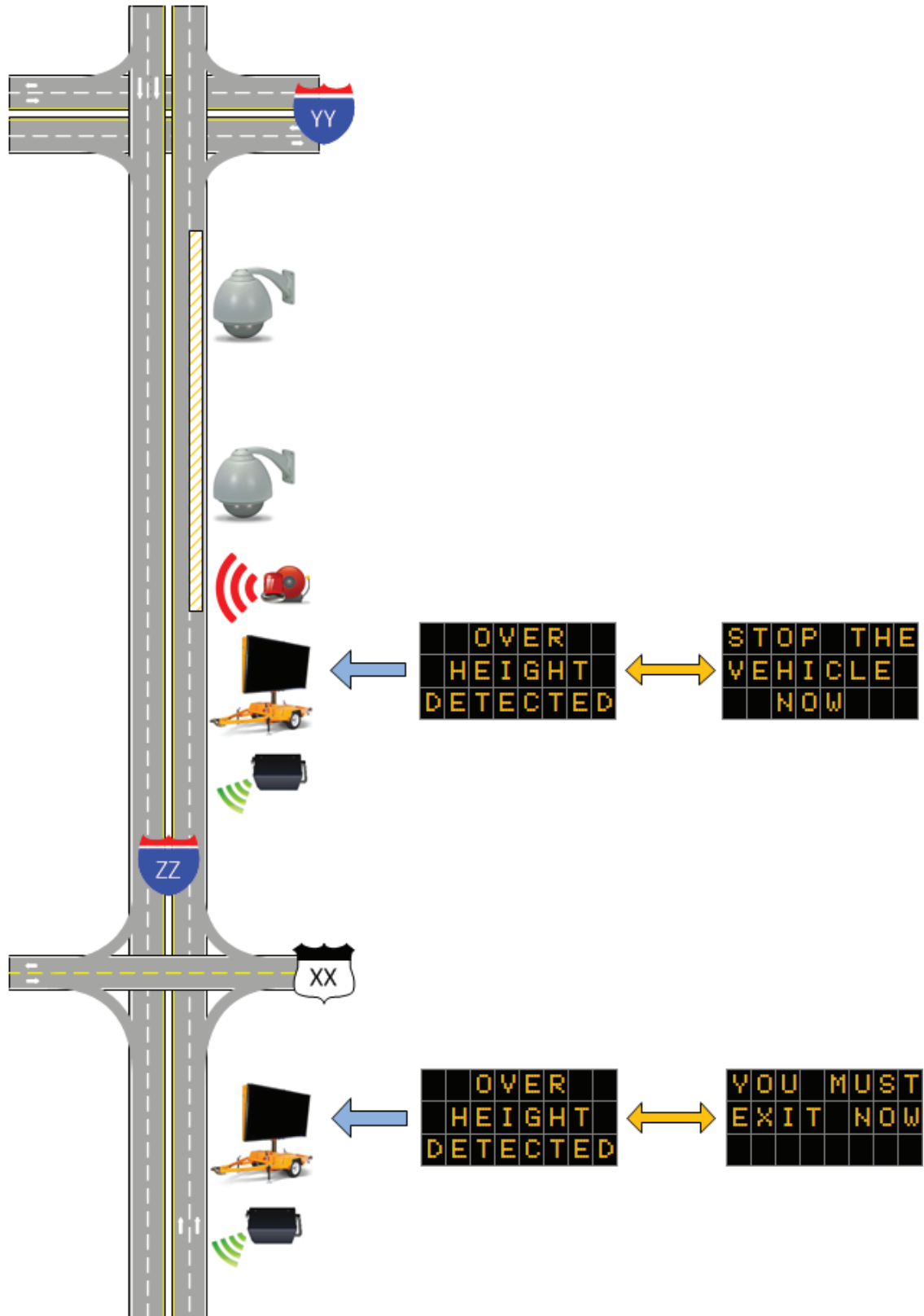

# Hazardous Condition Warning

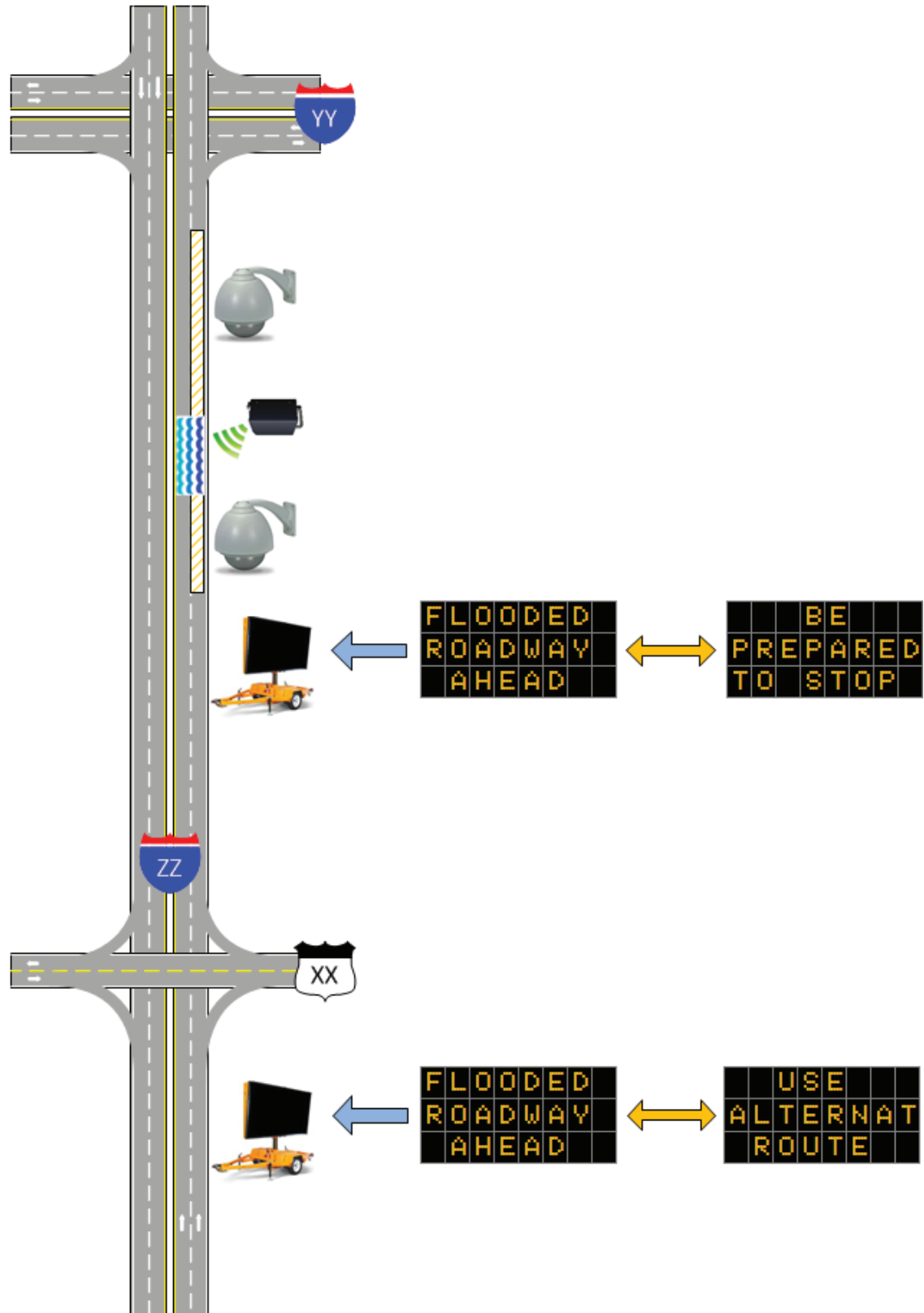



# Intrusion Warning

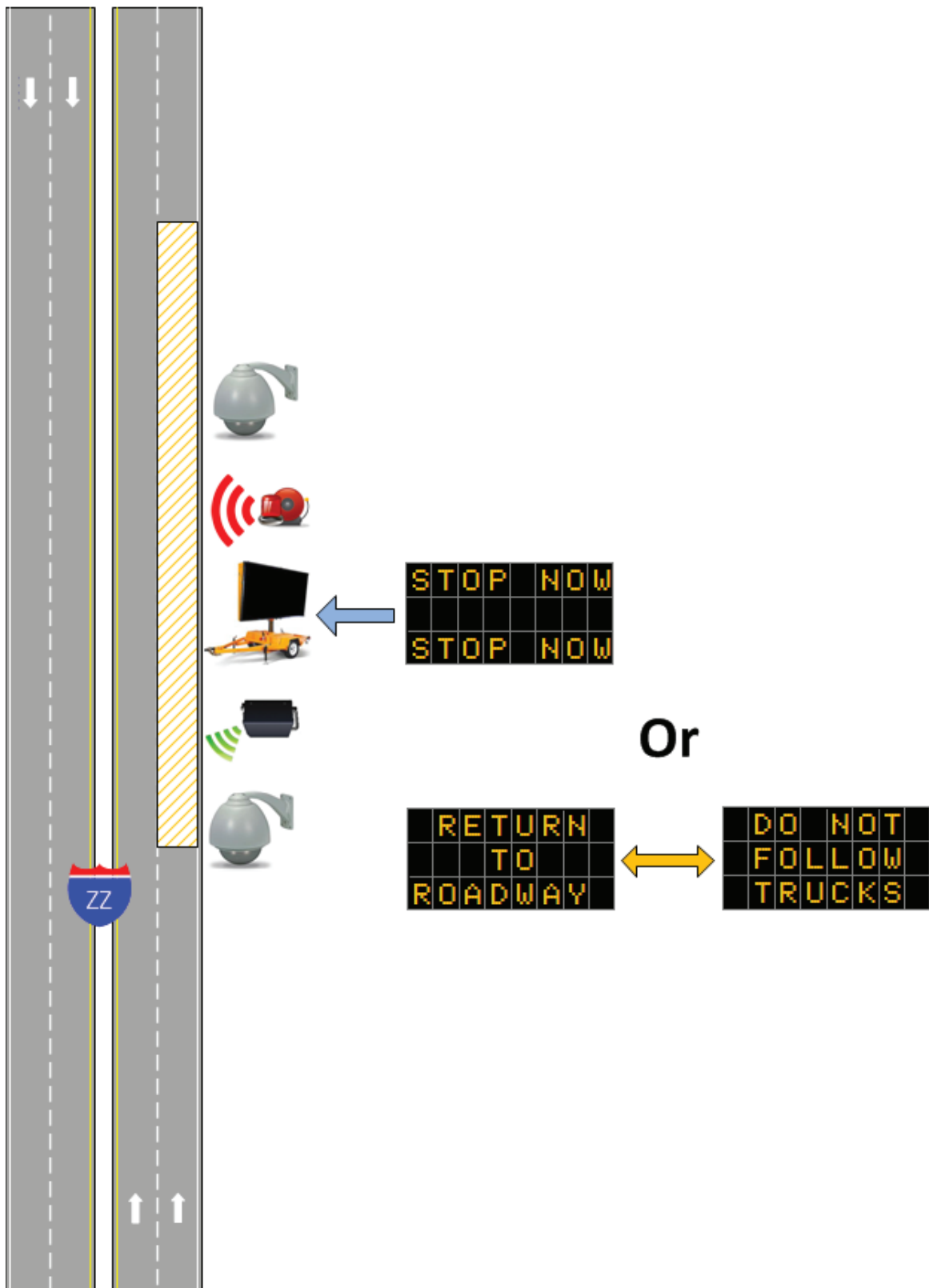

# Enforcement

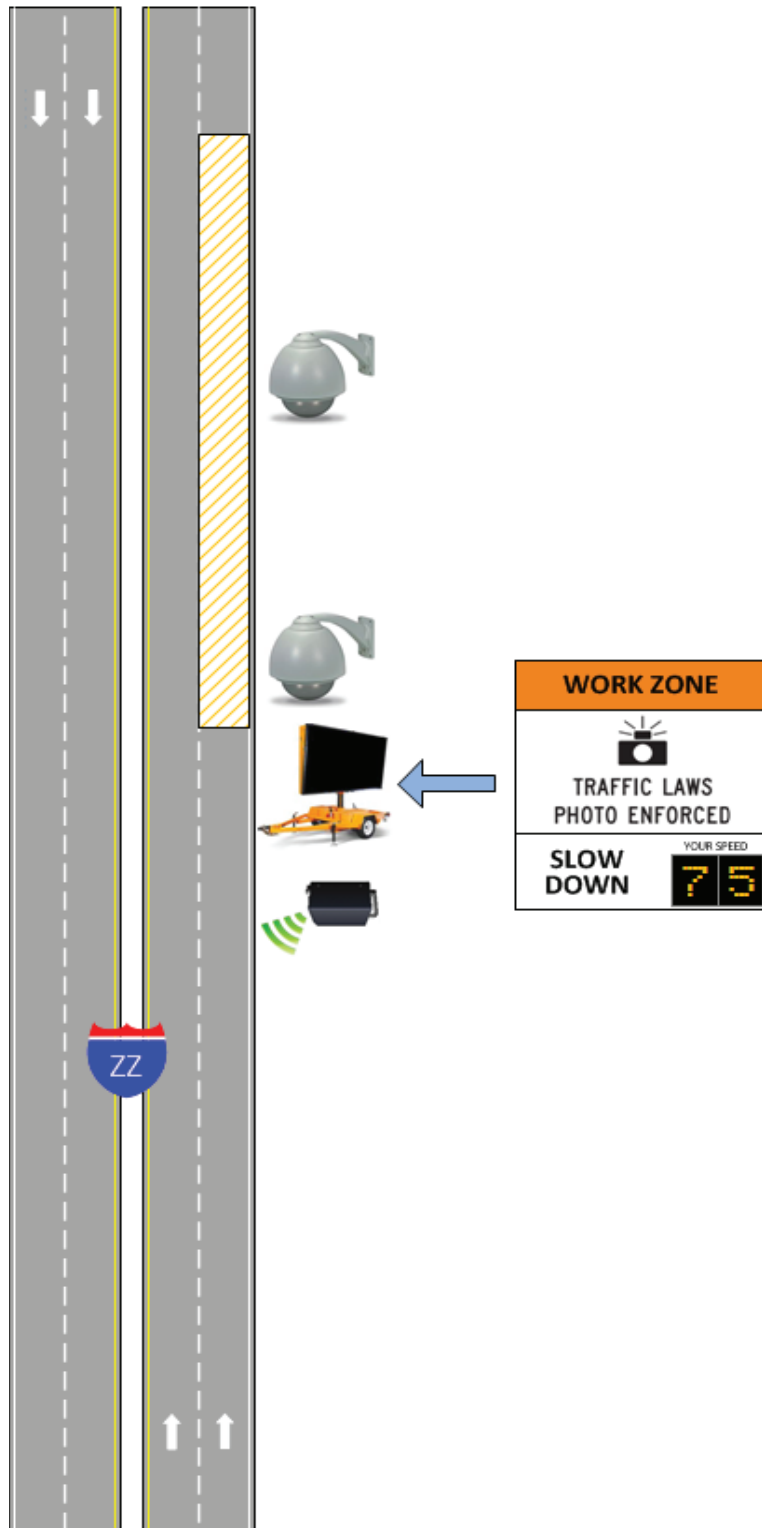

**Note:** The use of Photo Enforcement is not allowed under Massachusetts General Laws

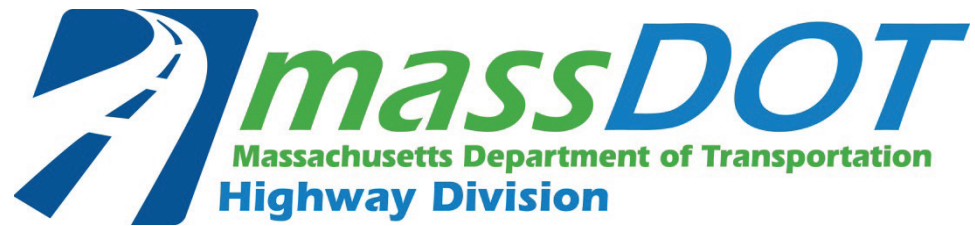

# **Smart Work Zone**

## **Standard Operating Procedures**

Version 1.1  
February 2016

# TABLE OF CONTENTS

LIST OF TABLES .....	iii
LIST OF FIGURES .....	iii
Acronyms .....	iv
1 Introduction .....	1
2 Smart Work Zone Regulation and Guidance .....	3
2.1 Federal Highway Administration (FHWA).....	3
2.2 Massachusetts Department of Transportation (MassDOT) .....	3
3 Definition of Work Zone Needs .....	4
3.1 Mobility Needs.....	4
3.2 Safety Needs.....	4
3.3 Work Zone Information Needs .....	5
3.4 Monitoring Needs .....	5
3.5 Enforcement Needs .....	6
4 Design of the Smart Work Zone.....	6
4.1 Work Zone ITS Solutions .....	6
4.2 Smart Work Zone Setups .....	8
5 Preparation .....	11
5.1 Evaluation plan.....	14
6 Deployment of the Smart Work Zone.....	15
6.1 Physical Deployment.....	15
6.2 Testing .....	16
6.3 Training and Support.....	20
7 Operation and Maintenance of the Smart Work Zone.....	20
7.1 Operation of Detection and Surveillance Equipment.....	21
7.2 Operation of Information Dissemination Systems .....	21
7.3 Operation of the Central Processing System .....	21
7.4 Operation of Communications and Power.....	22
7.5 Monitoring .....	22
7.6 Data Management & Archiving.....	22
7.7 System Maintenance.....	23
7.8 Smart Work Zone Supervisory Chain .....	24

8	References .....	25
8.1	Federal/State Laws and Code.....	25
8.2	Design Guidance.....	25
8.3	Supplemental Documents .....	25
	Appendix A. Mobility Surveillance SWZ Layout.....	27
	Appendix B. Travel Time Information SWZ Layout .....	28
	Appendix C. Expected Delay Information SWZ Layout .....	29
	Appendix D. Stopped or Slow Traffic SWZ Layout.....	30

## LIST OF TABLES

Table 1:	Detection and surveillance technologies used in SWZ.....	7
Table 2:	SWZ Setups .....	9

## LIST OF FIGURES

Figure 1:	Standard SWZ Operation Procedure Flow Chart .....	2
Figure 2:	Smart Work Zone Overview .....	6

## ACRONYMS

AASHTO	American Association of State Highway and Transportation Officials
CCTV	Closed-circuit Television
CMO	Construction Management Outline
DOT	Department of Transportation
FHWA	Federal Highway Administration
GPS	Global Positioning System
HAR	Highway Advisory Radio
HMS	Hybrid Message Sign
IMP	ITS Monitoring Plan
ITS	Intelligent Transportation System
MassDOT	Massachusetts Department of Transportation
MUTCD	Manual on Uniform Traffic Control Devices
USDOT	United States Department of Transportation
PIP	Public Informational Plan
PCMS	Portable Changeable Message Sign
RFID	Radio-frequency Identification
SOP	Standard Operating Procedures
SWZ	Smart Work Zone
TMP	Traffic Management Plans
TTCP	Temporary Traffic Control Plan

***Acknowledgement*** – *The Smart Work Zone Standard Operating Procedures were developed by Kanaan Consulting US, Inc. in cooperation with the MassDOT Traffic and Safety Engineering Section.*

# 1 INTRODUCTION

MassDOT's *Work Zone Transportation Management Procedures* specify the process to prepare Traffic Management Plans (TMP) for MassDOT's construction projects. One of the requirements of the TMP for certain project impact levels includes the development of a ITS Monitoring Plan (IMP). Design consultants will use MassDOT's *Smart Work Zone Design Standards* to evaluate various ITS technology applications to help mitigate the impacts of the road maintenance or construction work.

The following Standard Operating Procedures (SOP) have been prepared to guide contractors in support of the ITS Monitoring Plan component. The purpose of the IMP is to make work zone areas safer and more efficient through the use of Intelligent Transportation Systems (ITS) equipment, software, and communications to collect and analyze real-time data, compare it to established criteria, notify appropriate construction officials of undesirable conditions, and alert drivers about traffic conditions and suggest actions to be taken. This collection of actual ITS elements reflected in the IMP are known as a Smart Work Zone (SWZ).

The purpose this SOP document is to communicate the general steps for contractors to design, deploy, and operate SWZs. The development of the SOP adheres to the Federal Highway Administration (FHWA) Work Zone Regulation 23 CFR 630 Subpart J. The steps are summarized in *Figure 1* and described within the document. The SOP contains the following sections:

- **Section 1** introduces the document goals and the general steps to design, deploy, and operate a SWZ.
- **Section 2** presents the federal and state regulations, guidance, and policy on the use of ITS for the operation of work zones.
- **Section 3** SWZ describes the chief ITS applications to work zone operation and how identify the ITS needs for construction projects.
- **Section 4** identifies the ITS devices and systems that address the needs identified in Section 3.
- **Section 5** describes how to plan the SWZ system design and developing the evaluation plan.
- **Section 6** presents the considerations when deploying a SWZ and the operational test process.
- **Section 7** presents the considerations when operating and maintaining a SWZ.



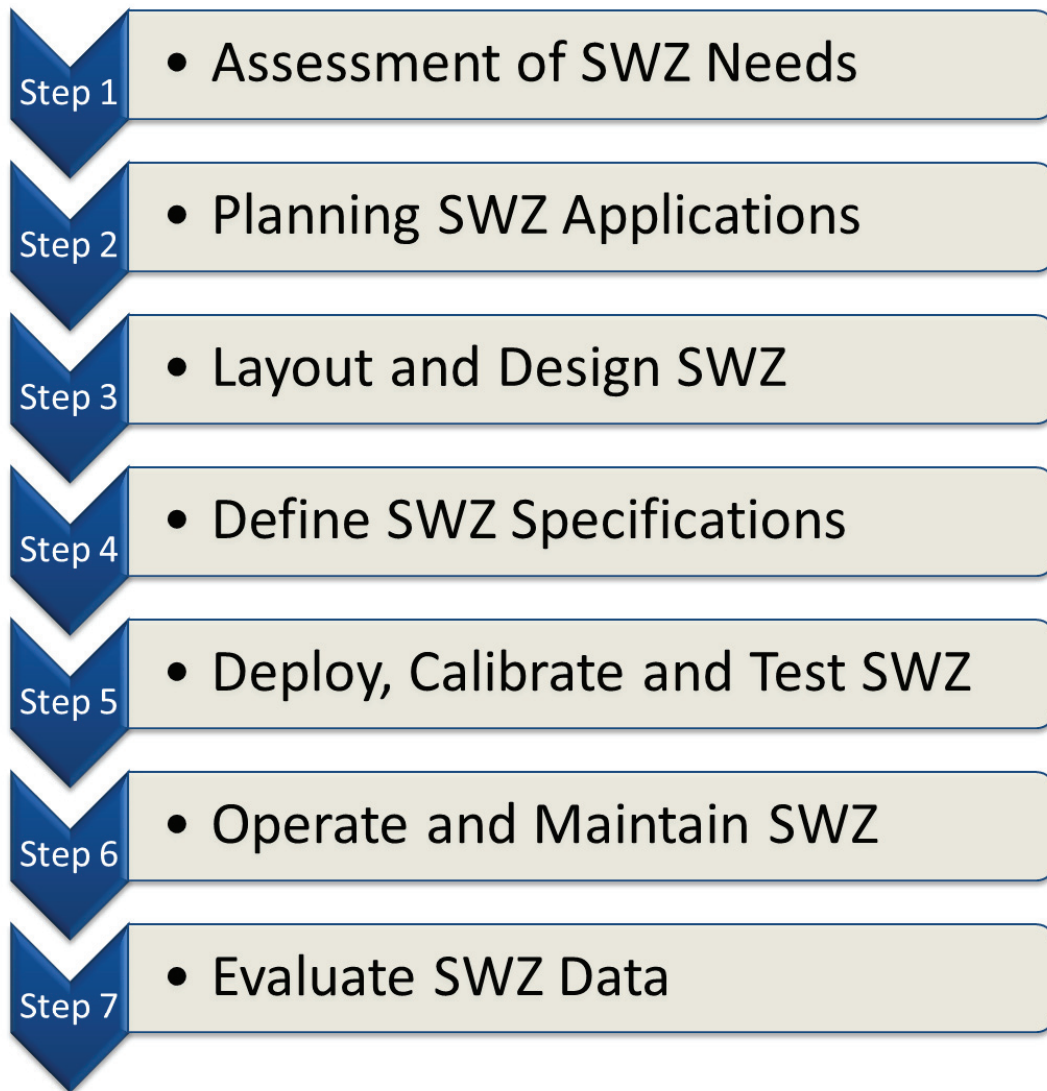

Figure 1 Process for Designing and Operating Smart Work Zones at MassDOT

## 2 SMART WORK ZONE REGULATION AND GUIDANCE

### 2.1 Federal Highway Administration (FHWA)

In September 2004, FHWA updated the *Work Zone Safety and Mobility Rule* 23 CFR 630 Subpart J. The Rule applies to all state and local governments that receive Federal-Aid highway funding for road and bridge construction projects. The rule outlined clear and definitive provisions and compliance dates for State and local transportation agencies that using Federal-Aid as follows:

- Define a clear and comprehensive process for evaluating and mitigating the impacts of construction work zones.
- Provide safe work zones for all workers and road users while also providing for the highest level of mobility.
- Define the evaluation techniques to be used during the planning, design, and construction phases of a project.

In 2007, FHWA issued the *Work Zone Operations Best Practices Guidebook* to provide a compilation of successful work zone operations practices used and recommended by several states and localities for other agencies to determine which of these practices are best suited for their particular situations. Some of those practices deal with the utilization of ITS systems to automatically collect and analyze data, and provide real-time information to motorists and to the construction team.

In addition to the aforementioned publications, FHWA has made available a number of resources developed by the academia, and local and state agencies for implementing various types of ITS in work zones. Such resources can be accessed through FHWA's Work Zone Mobility and Safety Program website<sup>1</sup>. The practices described in the guidebook and the website are intended as a descriptive, not prescriptive, depiction of the subject.

### 2.2 Massachusetts Department of Transportation (MassDOT)

In 2010, MassDOT developed the *Work Zone Transportation Management Procedures* to ensure compliance with the 2004 FHWA *Work Zone Safety and Mobility Rule* 23 CFR 630 Subpart J. The purpose of these procedures is to establish a clear and comprehensive process for evaluating and mitigating the impacts of construction work zones on the safety and mobility of both workers and the general public. The procedures built upon the existing practices and place special emphasis on evaluation of project impacts, definition of specific requirements, and collaboration between MassDOT and contractors early on the design process.

The procedures specify the steps to prepare Traffic Management Plans (TMPs) for MassDOT's construction projects. A TMP consist of four main components: Construction Management Outline (CMO), Temporary Traffic Control Plan (TTCP), Public Informational Plan (PIP), and ITS Monitoring Plan (IMP).

<sup>1</sup> <http://www.ops.fhwa.dot.gov/wz/its/index.htm>.

The procedures establish that TMPs for projects categorized at impact Levels 3 or 4, and Significant Project Status shall include an IMP (see *Work Zone Transportation Management Procedures* for description of impact levels) as part of the 75%, 100%, PS&E deliverables. IMPs can also be requested discretionally by the State Traffic Engineer for significant construction affecting vital community facilities such as a fire station, police station, school, or hospital; involving lengthy detours for motorists; or affecting locations that are normally subject to significant congestion or high crash rates. SWZ technology can also be used to aid drivers during special non-construction events. The procedures state that the IMP shall outline what mechanisms that will be employed to monitor traffic during construction and to notify the general public as changes occur.

In 2010, MassDOT developed the *ITS Strategic Plan*, which identifies the application of ITS in work zones during construction as an effective strategy to improve safety and lessen the delay generated by reduced capacity and incidents. Then, in 2011, MassDOT issued the *ITS Deployment and Design Guide*, which establishes general technical requirements for the design and operations of SWZs, including equipment specifications, communications, SWZ setup, and collected data. With the release of the *Smart Work Zone Design Standards* document in 2015, MassDOT now has official design guidance for the incorporation of SWZ systems in maintenance and construction projects.

### **3 DEFINITION OF WORK ZONE NEEDS**

The IMP shall identify the needs that will be addressed in every proposed work zone. Needs may be categorized into five groups, which in turn may be broken down into more specific needs as shown next. Work zones needs may be addressed using ITS solutions as described in Section 4. The IMP is only one part of the TMP, and not the unique solution to mitigate work zone impacts.

#### **3.1 Mobility Needs**

Mobility refers to SWZ's capability to ensure an efficient flow of traffic through the work zone, minimizing the congestion in the work zone through the reduction of traffic and/or the increase of the road capacity around the work zone.

- **Travel Time and Delay Estimation:** Provision of travel time and delay through the work zone in order to minimize driver's uncertainty.
- **Alternate Route Advisory:** Reduction the flow of traffic through the work zone by encouraging drivers to use alternate routes with lower travel times, comparing travel time estimations through the work zone and alternate routes, when available, to a common destination.
- **Dynamic Lane Merge:** Increase of the capacity of the road by fully utilizing available lanes up to the merge point.

#### **3.2 Safety Needs**

Safety refers to the SWZ's capability to minimize the number and severity of traffic-related incidents, injuries and fatalities, and asset damage in the work zone. Safety

strategies are intended to minimize surprise elements and sudden braking, and maximize driver alertness and predictability of driving conditions.

- **Work Zone Speed Limit:** Adjustment of the road's maximum speed according to the current nature, severity, and location of traffic, work zone, and environment conditions. \*Regulatory speed limit changes determined on case-by-case basis.
- **Excessive Speed Warning:** Warning to motorists when they are approaching the work zone at unsafe speeds by posting cautionary messages, such as "Exceeded Speed Limit, Reduce Speed Now" or the vehicle's actual speed.
- **Congestion warning:** Warning to motorists upstream of a work zone to slow down when there is stopped or slow traffic ahead.
- **Vehicle Warning:** Warning to drivers about construction vehicles merging into, entering, exiting or crossing the roadway.
- **Clearance Warning:** Warning to over-weight/over-height vehicles of construction-related weight or height restrictions and advise to divert from the route through the construction area.
- **Hazardous Condition Warning:** Warnings to motorists about temporary situations that may cause a hazardous driving condition through the work zone, such as flooding, low visibility (fog, smoke), slippery or rough conditions, and hazards on roadway (falling rock, debris).
- **Intrusion Warning:** Visual and acoustic alert to drivers and workers when an unauthorized vehicle has entered a restricted work area.

### **3.3 Work Zone Information Needs**

SWZ applications described in Sections 3.1 and 3.2 heavily rely on on-site information dissemination devices (e.g. PCMS) to post travel times, travel speeds, delays, alternate routes, work zone conditions, and warnings for drivers to make decisions when driving along the work zone. However, motorists in the vicinity of the work zone are not the only users to be informed. The information disseminated may be shared with others as well, for better work zone operation, coordination and decision support. Such users may include:

- Drivers not yet in the work zone area
- Other state or local DOTs
- Media outlets
- Contractors
- Commercial vehicle operators
- Emergency services providers
- Motorist assistance patrols
- Government and third-party traveler information providers

### **3.4 Monitoring Needs**

Work zone monitoring allows the work zone administrator to make decisions when collected real-time data show that the metrics specified for the project are deviating from predetermined thresholds. Monitoring also refers to the action of overseeing field

equipment, hardware, and software to ensure that collected data and published information are reliable, and that devices and systems are operating as intended.

Monitoring also allows MassDOT to verify the compliance (or lack thereof) with contractual criteria and apply penalties or incentives to the contractor. See Section 5.1 for applicable performance metrics.

### 3.5 Enforcement Needs

Automated enforcement may provide a cost-effective solution to ensuring compliance of needs described in Sections 3.1 and 3.2. Additional ITS equipment, such as CCTV cameras, photo speed cameras, and license plate recognition technology may be useful to detect and pinpoint aggressive and speeding drivers.

## 4 DESIGN OF THE SMART WORK ZONE

The IMP shall identify the ITS devices and systems that will address the needs identified in Section 3. The SWZ design also includes evaluation plan to monitor the SWZ performance.

### 4.1 Work Zone ITS Solutions

The IMP shall identify the ITS solutions that will address the work zone needs identified in the previous section. An ITS solution shall consist of detection and surveillance equipment, central processing system, information dissemination system, and communications and power, as shown in *Figure 2*. A common characteristic of equipment and systems used in SWZ is its portability as work zones are temporary and dynamic environments that require flexible setups.

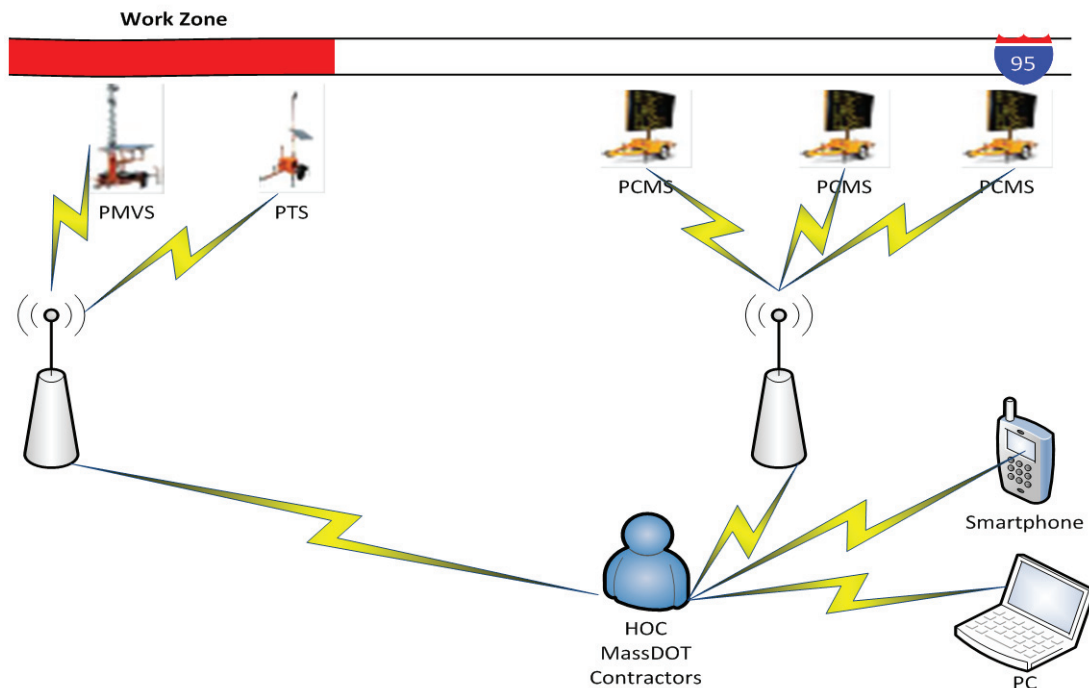

Figure 2 Smart Work Zone Overview

#### 4.1.1 Detection and Surveillance Equipment

Various types of detection and surveillance technology may be used in SWZ. *Table 1* presents the most common technologies utilized.

**Table 1 Detection and Surveillance Technologies Used in SWZs**

Detection Technology	Collected Data
Radar	Volume, Speed
Pneumatic Road Tubes	Volume, Speed, Classification
Infrared	Volume, Speed, Classification
Acoustical	Volume, Speed
Ultrasonic	Volume, Occupancy
Microwave	Volume, Speed, Classification
Magnetic	Volume, Speed
Piezo-electric	Volume, Speed, Classification, Weight
Image (Video – Photo)	Volume, Video, Photo, Incident
RFID	Volume, Travel Time, Identification
Probe Technology	Volume, Travel Time
License Plate Recognition	Travel Time, Plate Number (for enforcement)
Environmental	Weather data, Road conditions

Although video technology has the capability to automatically detect vehicle passing and incidents, Closed-circuit Television (CCTV) surveillance cameras may also be used by traffic management personnel to monitor the work zone and verify traffic conditions and incidents.

RFID and probe technologies (e.g. cellular signal, Bluetooth, GPS) are adequate technologies as long as the vehicles or drivers have the ability to emit the appropriate signals for the detection devices to read them.

#### 4.1.2 Central Processing System

The central control system is a collection of hardware and software that acts as SWZ computer to control the field devices, use algorithms to analyze and process traffic data, and send information to the output devices and systems. The processing system also includes the databases to store collected data. The processing system may be a located in the work zone, a MassDOT office or a third-party provider facility.

#### 4.1.3 Information Dissemination System

Various types of dissemination devices and systems may be used in SWZ.

- Portable Changeable Message Sign (PCMS): Electronic signs used to display traffic conditions, travel times, incident information, and advisory messages.
- Hybrid Message Sign (HMS): Static signs with a fixed legend and two-character electronic insert for the provision of travel times.



- Highway Advisory Radio (HAR): Broadcasting of travel information in low band, AM frequencies, typically used in conjunction with a static signs or PCMS that tells drivers which frequency to turn to.
- Audible alarms: Acoustic alerts as a complement of visual devices for specific needs (e.g. work zone intrusion).
- Websites: Publication of travel information on MassDOT, 511, and third-party websites for pre-trip planning purposes. They may provide detailed information on speeds, delays, congestion alternate routes, PCMS messages, video images, and contractor schedules.
- 511 Telephone System: Travel information may be relayed to Mass 511 operator to be consulted by drivers.

#### **4.1.4 Communications and power**

Given the portability of SWZ equipment, communications commonly use wireless technology to integrate detection devices, central processing system, and dissemination systems. Hard wired communications may be possible if physical connections are available in the work zone area. Communications technology for SWZ may include:

- Wireless Ethernet
- Cellular telephone
- Hard wired cable
- Optical
- Radio frequencies
- Satellite

Battery and solar technologies are typically the power choices for SWZ. As the communications case, hard wired power may be used if available in the area.

## **4.2 Smart Work Zone Setups**

Each combination of ITS elements leads to a different SWZ setup that addresses a specific need, as presented in *Table 1*. Column “Data Requirements” describes the type of data that must be collected for each need. The SWZ designer shall pick a technology from *Table 1* that is capable of collecting such data. The SWZ designer shall also define a central processing system, and communications and power options that better suits each specific setup.

The last column of every need in *Table 1* shows an appendix number to this document that presents a typical setup that may be used as guidance to design the appropriate SWZ setup. Those diagrams are intended as guidelines that should lead to practical solutions by the designer. Dimensions are not drawn to scale, and the location and quantity of devices are merely conceptual, so engineering judgment is required to customize the system to a specific project. The Massachusetts ITS Deployment and Design Guide, and other MassDOT and FHWA documentation provide guidance on devices location, but the designer should always keep in mind that the detection equipment usually extends beyond the limits of the work zone. The designer may propose emerging technologies outside what is recommended in this document as long as functionalities remain intact.



Table 2 SWZ Setups

Need	Specific Need	Data Requirements	Dissemination Device/System	Appendix
Mobility Needs	Travel Time and Delay Estimation	- Speed or Travel Time	- PCMS and/or HMS - Website - 511 Telephone - HAR (Optional)	B
	Alternate Route Advisory	- Speed or Travel Time	- PCMS and/or HMS - Website - 511 Telephone - HAR (Optional)	C
	Dynamic Lane Merge	- Volume - Occupancy	- PCMS - HAR (Optional)	
Safety Needs	Variable Speed Limit	- Speed or Travel Time - Volume - Occupancy - Weather - Road Conditions - Incident (Optional)	- PCMS and/or HMS - HAR (Optional)	
	Excessive Speed Warning	- Speed	- PCMS and/or HMS	
	Congestion warning	- Speed or Travel Time - Volume - Occupancy	- PCMS - Website - 511 Telephone - HAR (Optional)	D
	Vehicle Warning	- Volume - Identification	- PCMS	
	Clearance Warning	- Classification - Weight	- PCMS - Audible Alarm	
	Hazardous Condition Warning	- Weather - Road Conditions	- PCMS - Website - 511 Telephone - HAR (Optional)	
	Intrusion Warning	- Identification	- PCMS - Audible Alarm	
	Work Zone Information Needs	N/A	Subject to specific mobility or safety need	Subject to specific mobility or safety need
Monitoring Needs	N/A	Subject to specific mobility or safety need	Subject to specific mobility or safety need	

Need	Specific Need	Data Requirements	Dissemination Device/System	Appendix
Enforcement Needs	N/A	- LiDAR or Radar / Speed Reader Board	- PCMS - HAR (Optional)	

The SWZ designer shall include collection of video feed from all work zones regardless the addressed need in order to ensure continuous monitoring, incident and conditions verification, and support on incident response activities.

Additional considerations shall be taken into account when designing a SWS setup:

- An IMP shall be prepared specifically for each construction project categorized at impact Levels 3 or 4, Significant Project Status, or requested discretionally by the State Traffic Engineer. The IMP shall be submitted as part of the 75%, 100%, PS&E project deliverables. The IMP shall include:
  - Work zone needs to address
  - Proposed devices and systems plans, specifications, and locations
  - Data to be collected
  - Central processing system specifications
  - Communication and power systems specifications
  - SWZ deployment plan
    - Physical deployment plan
    - Operational Testing plan
    - Training and support plan
  - SWZ operation and maintenance plan
  - SWZ evaluation plan (see Section 5.1)
- The SWZ design shall incorporate adequate flexibility given work zones highly variable environments, temporality, and potential need for adjustments during deployment.
- SWZ design shall be prepared by professional engineers with appropriate training and experience. SWZ must be designed in accordance with the general guidelines contained in this document, and include details outlined by MassDOT for each individual construction project.

## 5 PREPARATION OF THE SMART WORK ZONE

The first step of SWZ deployment is to review the SWZ design and plan for equipment installation. The design provided in a contract should meet MassDOT's SWZ Design Standards, but it may not specify all of the details required to implement a SWZ. For example, MassDOT may describe the data that needs to be collected and allow the contractor to decide which technologies to use. MassDOT may also allow the contractor to set the construction schedule and phasing. The contractor is ultimately responsible for ensuring that the SWZ deployment meets contractual obligations and MassDOT standards, so the contractor must revisit the design and proposed approach before deployment.

The following steps can be taken:

1. Review the proposed construction schedule and confirm that the SWZ design provides adequate coverage for each phase. If construction activity will move, plan SWZ set-ups for each configuration, relocating equipment as necessary.
2. Identify equipment to be used on the job. Confirm that the proposed equipment on the SWZ design is adequate, that is, ensure that it meets the contractual obligations and work zone requirements, discussing any discrepancies or changes with MassDOT.
3. Check the manufacturers' guidelines for installation and operation requirements.
4. Coordinate with MassDOT to schedule a visit to the work site. concluding
5. At the site, visit the proposed location for each device (use coordinates provided by designers). Check that the equipment location is<sup>2</sup>:
  - a) In compliance with manufacturers' guidelines.
  - b) Located outside clear zones unless approved by MassDOT.
  - c) Protected with barriers (such as guardrails or concrete barriers) when practical and does not interfere with the devices' intended capabilities.
  - d) Placed on level and firm ground.

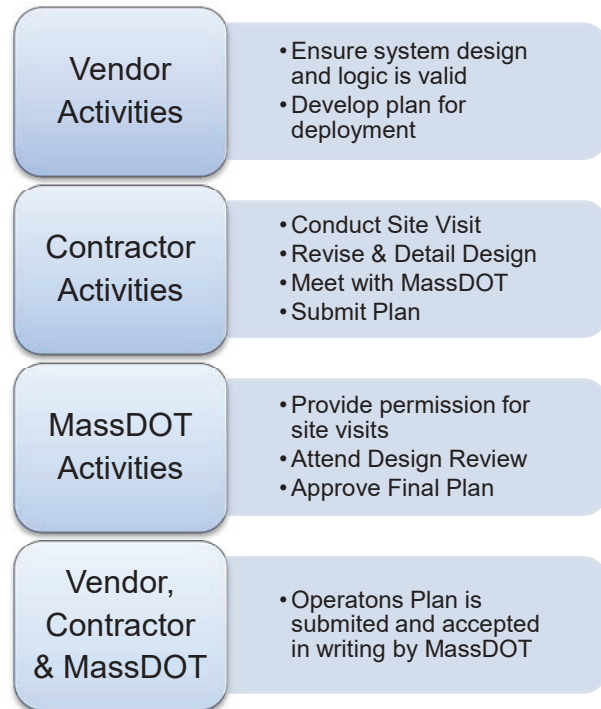

Figure 3: Preparation for Smart Work Zone Deployment

<sup>2</sup> These location guidelines are also taken into account for the design of the SWZ. However, site conditions may change between the design period and the deployment and operation periods. The contractor must ensure that the standards are still met.

- e) Located where it can be easily installed, uninstalled, moved, and maintained with minimal disruption to traffic.
  - f) Not impacting wetlands.
  - g) Not disrupted or obstructed by bridges, trees, rock walls, etc. This is especially critical for wireless communications and solar power.
  - h) Located in such a way that it can satisfy the applications or purposes for which it was intended, including more than one if required. Ensure that:
    - i. Cameras provide good sight coverage of the relevant location. Cameras should avoid blind spots, seasonal sun-blindness, and visual obstructions (bridges, overpasses, viaducts, foliage, buildings, etc.). Placement of cameras on the outside of a highway curve usually provides better visual coverage. Use a bucket truck or similar lifting device to check the actual coverage that the camera would provide.
    - ii. Detection equipment is placed in a way that guarantees collection of accurate data. When placing detection equipment take into account:
      - Orientation, distance, and height of the device with respect to the traffic
      - Spacing between devices
      - Extreme congestion with stop-and-go traffic conditions
      - Presence of obstructing structures such as bridges, median barriers, and signs
    - iii. Signs (PVMS and HMS) are correctly placed. Make sure that signs:
      - Meet MassDOT minimum spacing requirements. If minimum spaces are not possible, it may be necessary to strategically co-locate signs or use one sign for multiple purposes.
      - Be placed in locations where motorists would find them useful, typically before major decision points (e.g. exits or intersections), with enough advance warning that motorists can safely change course.
      - Be visible and understandable to motorists at a reasonable site distance despite embankments, medians, slopes, and sunlight exposure present in the area.
6. Prepare a general deployment schedule, indicating the activities required to deploy, initialize and test the equipment.
7. Meet with MassDOT to present the planned approach and deployment schedule. During this meeting, present the field visit results, updated site plans, data

collection plans, and an equipment phasing schedule. Be prepared to justify any changes to the original design or specifications.

8. When the plan is approved by MassDOT (this may require a period of time and several discussions with MassDOT), procure the SWZ equipment.
9. Complete licensing and registration of new trailers with the RMV. Check with RMV for the required documentation (e.g. Certificates of origin, vehicle information sheets, RMV forms). If trailers are already licensed, ensure they are properly registered in the US.
10. Coordinate with MassDOT and other contractors within the contractor team as necessary to plan the site preparation, equipment installation, integration, and testing. *\*See Section 5.1 Deployment*
11. Setup contracts for communication services, such as FCC licensing, cellular telephone, wireless data networks, satellite and Internet subscriptions.
12. Configure the central processing system and ensure that it is prepared to receive, analyze, archive, and disseminate data and meet contractual requirements.
13. Set up a SWZ web interface for monitoring the work zone. The web interface must include at least the following:
  - a) Continuous operation (24 hours a day, 7 days a week) for the duration of the project, unless otherwise directed by MassDOT.
  - b) Full color map depicting the project area with locations of field equipment. The map must reflect the current traffic conditions (e.g. travel time, delay, and queues) at each detector location, the messages being shown by each PVMS and HMS, and equipment operational status.
  - c) Video images from the cameras on the work zone.
  - d) Capability to manually override devices, messages and systems.
  - e) Monitoring of equipment and systems to detect malfunction in devices, power, and communications.
  - f) Submission of alerts to designated personnel when equipment and systems malfunction. Alerts include communications disruptions, loss of power, low battery, etc.
  - g) Multiple user types with different access and permission levels to applications and actions.
14. Verify with MassDOT the level of access and privileges of the agency staff to view data and video, and control and monitor the work zone through the web interface.
15. Assign usernames and passwords to MassDOT personnel according to each person's privileges.

## 5.1 Evaluation plan

The IMP shall include an evaluation plan with specific, measurable and attainable metrics to establish the degree of usefulness of the proposed SWZ. The specific measures tracked shall be aligned with the needs and SWZ setup defined previously. Metrics may be used to make changes to the SWZ during deployment and operation stages, as well as to the work zone itself.

Typically, metrics of a SWZ can be categorized as follows:

- Mobility
  - Travel time
  - Delay
  - Rate of diversion (traffic volumes on mainline and alternate routes)
  - Speeds
  - User satisfaction with travel through the work zone(surveys)
  - Queue lengths
- Safety
  - Number of incidents
  - Incident severity
  - Citations
  - Reduction in observed aggressive maneuvers and forced merges
- Dissemination of information
  - User satisfaction with disseminated information (surveys)
  - Penetration of alternate dissemination systems (HAR, website, 511)
- System performance
  - Collected and published data accuracy
  - Collected and published data availability
  - Error logs
  - Devices and system status
  - Down time
  - Productivity
  - Workers' exposure to hazards
  - Construction efficiency

Additional considerations shall be taken into account when developing the evaluation plan:

- The IMP shall determine acceptable thresholds and ranges for selected metrics, according to:
  - Work zone location and size
  - MassDOT and FHWA regulations
  - Road capacity
  - Day of the week and hour of the day
  - Accident rate in the area
  - Historic information
  - Anecdotal evidence from MassDOT operations and planning staff

- The IMP shall determine the periodicity of metric estimation and reporting to MassDOT.
- The IMP shall describe the data sources and computation method for every metric.

## 6 DEPLOYMENT OF THE SMART WORK ZONE

Once MassDOT has approved the design, the entire SWZ setup shall be deployed according to the SWZ deployment plan. SWZ deployment shall have three components:

- Physical deployment
- Testing
- Training and support

### 6.1 Physical Deployment

The physical deployment (installation) of field equipment and the provision of ancillary services should occur within a week of construction activity or as required by contract. This step should be coordinated with MassDOT Districts and other contractors on the site. Deploy equipment according to the following steps:

1. Prepare the locations to receive the equipment in accordance with the site visit findings and the updated design.
2. Coordinate the delivery of the devices and mobilize them off-site. Coordinate with MassDOT if a MassDOT facility should be used. Coordinate with MSP, if required.
3. Prepare the devices as directed by the manufacturer:
  - a) Assign a unique ID, name, and IP address to each device.
  - b) Install support hardware, such as trailer, hydraulic lift, display, keyboard, controller, GPS, etc.
  - c) Install and update equipment software and firmware, including library messages and control applications.
  - d) Install communications equipment and systems, such as modems, wireless data networks, base stations, cell phone data interfaces, Ethernet network interfaces, internet interfaces, and security protocols.
  - e) Install power equipment, such as solar panels, battery or continuous power sources.
  - f) Install security elements, such as padlocks, to prevent unauthorized access to cabinets and configuration systems.
  - g) Furnish and install other elements required by the project's contract.
4. Test the individual components and systems before installation in the field to ensure components are operational and fully functional before deployment in the field.



5. Install the equipment in the field, coordinating with MassDOT districts as needed to gain shoulder access and coordinate lane closures.

## **6.2 Testing**

Test the SWZ system to ensure that it complies with the design and the contract. Individual equipment testing should be conducted off-site (e.g. depot, warehouse) and on-site (work zone). SWZ system testing conducted on-site must be approved by MassDOT prior to testing. Test the SWZ according to the following steps:

1. Develop an Operations Test Plan and reporting mechanism for submitting records of the tests to MassDOT.
2. The contractor shall test the SWZ setup to ensure it is operating as designed, including but not limited to:
  - a) System functionality
  - b) System performance
  - c) Data availability, reliability, and storage
  - d) System failure
  - e) Communications and power
3. The contractor shall maintain records of the tests results and submit reports to MassDOT detailing the daily activity during the operational test.
4. Testing Reports should include:
  - a) Tested requirements
  - b) Minimum pass/fail criteria
  - c) Test result discrepancy
  - d) Testing equipment used

*Table 3* and *Table 4* provide sample criteria for testing detection and surveillance equipment and dissemination equipment, respectively.

5. During the testing period, if any equipment or system malfunctions or is damaged due to crashes, vandalism, adverse weather, etc. during the operational test, the contractor shall conduct the necessary activities to fix the anomaly. The contractor shall report:
  - a) Date and time of malfunction
  - b) Identification of the defective equipment or system
  - c) Cause of equipment or system malfunction
  - d) A description of the type of work performed
  - e) Time required to repair or replace the equipment or system
  - f) Field testing results

**Table 3: Test Criteria for Detection and Surveillance Equipment**

<b>Equipment</b>	<b>Testing criteria</b>
Traffic Sensor <sup>3</sup>	<ul style="list-style-type: none"> <li>- Device is detecting individual passing vehicles.</li> <li>- Device is collecting correct data (e.g. volume, speed, occupancy, classification, weight, motion).</li> <li>- Device can be operated and data can be viewed locally at the device's cabinet.</li> </ul>
Video cameras	<ul style="list-style-type: none"> <li>- Camera has pan-tilt-zoom capabilities.</li> <li>- Camera has the capability to configure "presets", each with defined pan/tilt position, zoom and focus settings.</li> <li>- Camera has image stabilization capabilities.</li> <li>- Camera has image processing capabilities for low light conditions and balance of light and dark areas.</li> <li>- Camera can be controlled and video images can be viewed locally at the device's cabinet.</li> </ul>
Short-Range Transmitter Receiver Systems <sup>4</sup>	<ul style="list-style-type: none"> <li>- Device is capturing electronic signals of passing vehicles.</li> <li>- Device can be operated and data can be viewed locally at the device's cabinet.</li> </ul>
Vehicle Probes	<ul style="list-style-type: none"> <li>- Device is collecting correct data (e.g. speed, location).</li> </ul>
Environmental	<ul style="list-style-type: none"> <li>- Device is collecting correct data (e.g. weather).</li> <li>- Device can be operated and data can be viewed locally at the device's cabinet.</li> </ul>

**Table 4: Testing Criteria for Dissemination Equipment**

<b>Equipment</b>	<b>Testing criteria</b>
Portable Variable Message Sign (PVMS)	<ul style="list-style-type: none"> <li>- All sign LEDs are fully functional.</li> <li>- When turned off or blanked, all LEDs are off.</li> <li>- Device automatically adjusts visibility for low light conditions or nighttime operations.</li> <li>- Device can be operated and messages can be posted and overridden locally at the device's cabinet.</li> <li>- Phase duration is at least one second per word.</li> <li>- Device is visible from ¼ mile and letters on the device are legible from 800 feet.</li> </ul>
Hybrid Message Sign (HMS)	<ul style="list-style-type: none"> <li>- All sign LEDs are fully functional.</li> <li>- When turned off or blanked, all LEDs are off.</li> <li>- Device automatically adjusts visibility for low light conditions or nighttime operations.</li> <li>- Device can be operated and messages can be posted and overridden locally at the device's cabinet.</li> <li>- Device is visible from ¼ mile and letters on the device are legible from 800 feet.</li> </ul>

<sup>3</sup> Many technologies exist including Radar, Microwave, Pneumatic Road Tubes, Infrared, Acoustical, Ultrasonic, Magnetic, and Piezo-electric. Radar and Microwave are the most common at MassDOT.

<sup>4</sup> There are many different technologies. Radio Frequency Identification (RFID) and Bluetooth are the most common at MassDOT.

Highway Advisory Radio (HAR)	- Information is broadcast in the correct AM frequency. - Broadcast range covers at least the closest upstream decision point.
Audible alarms	- Alarm sounds at 125 dB for at least 15 seconds.

6. Test ancillary services (communications and power).
  - a) Verify that the device’s modem is sending and receiving data to/from the SWZ web interface.
  - b) Verify that communications are reliable (e.g. sufficient bandwidth during peak periods).
  - c) Verify that solar panels are adequately installed and batteries are charging.
  - d) Verify that power source is reliable (e.g. sufficient battery size), as evidenced in provided power calculations provided by the designer.
7. Test SWZ data collection, dissemination, and archiving functionalities. See Section 7.6 for data collection and archiving requirements and criteria.
8. Test the SWZ setup as a whole from the public viewpoint, that is, test the accuracy of data and information disseminated to the public through on-site devices (PVMS, HMS, HAR, Alarms). The following table (Table ) provides suggested testing methodologies and results for each SWZ application<sup>5</sup>:

**Table 5: Testing Criteria for Smart Work Zone Functions**

<b>Application</b>	<b>Testing methodology</b>	<b>Required Result</b>
Driver Alerts	- Observation of posted messages - Floating vehicle	- Clear messages
Travel Time and Delay Estimation	- Comparison of travel times to those provided by external sources (e.g. Google, INRIX, Traffic.com), if matching segments available	- Published travel time or delay through the work zone is 95% accurate
Alternate Route Advisory	- Floating vehicle - Comparison of travel times to those provided by external sources (e.g. Google, INRIX, Traffic.com), if matching segments available	- Published travel times are 95% accurate
Dynamic Lane Merge	- Use of detection devices’ internal software*	- Messages directing motorists to use all open lanes up to a metered merge point - Messages directing motorists to merge at the merge point

<sup>5</sup> See the *Smart Work Zone Design Standards* document for a detailed description of the mobility and safety SWZ applications that disseminate data and information to the public.

Application	Testing methodology	Required Result
Congestion Warning	<ul style="list-style-type: none"> <li>- Drive through congested road (if available before initiating works)</li> <li>- Use of detection devices' internal software*</li> </ul>	<ul style="list-style-type: none"> <li>- Messages recommending motorists to take alternate routes</li> <li>- Messages warning motorists upstream of the work zone to slow down</li> </ul>
Excessive Speed Warning	<ul style="list-style-type: none"> <li>- Detection of speeding vehicles during SWZ operation</li> <li>- Use of detection devices' internal software*</li> </ul>	<ul style="list-style-type: none"> <li>- Messages warning motorists about their unsafe speeds</li> <li>- Messages indicating the vehicles' actual speeds</li> </ul>
Vehicle Warning	<ul style="list-style-type: none"> <li>- Construction vehicle merging into, entering, exiting, or crossing the roadway</li> </ul>	<ul style="list-style-type: none"> <li>- Messages and audible alarms warning motorists about construction vehicles merging into, entering, exiting, or crossing the roadway</li> </ul>
Clearance Warning	<ul style="list-style-type: none"> <li>- Oversized vehicles driving through the detection zone</li> <li>- Use of detection devices' internal software*</li> </ul>	<ul style="list-style-type: none"> <li>- Messages and audible alarm warning motorists and workers about construction-related weight, height, or width restrictions.</li> <li>- Messages urging motorists to exit the road</li> </ul>
Hazardous Condition Warning	<ul style="list-style-type: none"> <li>- Detection of hazardous conditions during SWZ operation</li> <li>- Use of detection devices' internal software*</li> </ul>	<ul style="list-style-type: none"> <li>- Messages recommending motorists to take alternate routes</li> <li>- Messages warning motorists about hazardous situations</li> </ul>
Intrusion Warning	<ul style="list-style-type: none"> <li>- Unauthorized/unidentified vehicle entering the restricted area</li> </ul>	<ul style="list-style-type: none"> <li>- Messages and audible alarm warning motorists and workers about an unauthorized entering the work area</li> <li>- Messages urging the motorists to stop or abandon the work zone</li> </ul>
Enforcement	<ul style="list-style-type: none"> <li>- Detection of speeding vehicles during SWZ operation</li> <li>- Use of detection devices' internal software*</li> </ul>	<ul style="list-style-type: none"> <li>- Messages indicating the vehicle actual speed and enforcement activities.</li> </ul>

\* Some applications cannot be tested under real conditions until the work zone is in operation. Devices' internal software can be used to mimic the desired traffic conditions by generating artificial inputs and measuring the outputs (e.g. PVMS/HMS messages, audible alerts) to verify that the requirements have been met.

9. Test additional software (e.g. programming, firmware) and hardware (e.g. cabling, mechanical connections) requirements as indicated by manufacturers and the project's contract.
10. The contractor, under MassDOT supervision, shall validate the accuracy of collected and published data through various means, such as manual observation of field volumes and probe vehicles to measure travel time and delays.

11. Set up on-site and/or off-site demonstration of the SWZ for MassDOT personnel if requested.
12. Once the operational test report and in-situ demonstration are approved by MassDOT, the SWZ system will be considered operational and the system will be accepted for use.

### **6.3 Training and Support**

Training and support ensures that SWZ operation knowledge is transferred to MassDOT for monitoring and oversight purposes.

1. Set up training sessions for MassDOT personnel that will monitor, operate, and control the SWZ.
2. Design the training sessions as hands-on, practical exercises utilizing the actual installed equipment when possible.
3. The contractor shall provide MassDOT with login information (users and password) according to access privileges (see Section 7.8), as well as procedures to use the SWZ web interface
4. Furnish MassDOT with procedures, manuals, notes, and other materials necessary for the SWZ operation including but not limited to:
  - a) Data monitoring, video viewing, and device control procedures
  - b) Contents and format of posted messages
  - c) Instructions to override messages on PVMS in the event of an emergency
  - d) Instructions to troubleshoot the system in the event of a power failure, communications, and equipment failure
  - e) List of telephone numbers to request technical support
5. Conduct follow-up training sessions in order to address operational issues or additional training if requested by MassDOT.
6. Coordinate with MassDOT Public Information Office to determine ways to educate the public about the dissemination tools (e.g. project's website, MassDOT website, Mass 511 website) if necessary and available.

## **7 OPERATION AND MAINTENANCE OF THE SMART WORK ZONE**

The contractor shall operate and maintain the SWZ setup according to the SWZ operation and maintenance plan:

1. The contractor shall perform routine inspection, and corrective and preventive maintenance of the SWZ equipment and systems.
2. ITS equipment and systems shall be capable of autonomously restarting to normal operations when communications or power is resumed after a failure.

3. The contractor shall relocate, uninstall, and remove SWZ elements if the field conditions require it, without compromising the setup performance. Modifications shall be approved by and coordinated with MassDOT.
4. If any equipment or system malfunctions or is damaged due to crashes, vandalism, adverse weather, etc. during regular operation, the contractor shall conduct the necessary activities to fix the anomaly. The contractor shall report:
  - a) Date and time of malfunction
  - b) Identification of the defective equipment or system
  - c) Cause of equipment or system malfunction
  - d) A description of the type of work performed
  - e) Time required to repair or replace the equipment or system
  - f) Field testing results

### **7.1 Operation of Detection and Surveillance Equipment**

1. The detection devices shall continuously send data to the central processing system.
2. Flaggers, police officers, and construction workers may also be used as detection sources. For instance, they may operate devices to identify construction vehicles, which is an input for intrusion and vehicle warning applications.
3. The contractor shall maintain equipment unobstructed and in operating conditions to ensure appropriate data collection.

### **7.2 Operation of Information Dissemination Systems**

1. Data received from the central processing system shall be continuously published.
2. Audible alarms should be used for application in which non-compliance with posted messages may lead to serious incidents (e.g. oversized vehicle restriction, work zone intrusion).
3. PCMS used in temporary ITS applications (e.g. dynamic lane merge, congestion warning, vehicle warning, clearance warning) should post alternative messages when the primary application is no needed (e.g. no congestion, no construction vehicle entering or exiting). Messages for other ITS applications, such as travel times and advisory messages, should be posted instead of having a blank PCMS.
4. Dissemination devices, such as PCMS and HMS, shall not override or replace required static signs as stipulated by MUTCD.

### **7.3 Operation of the Central Processing System**

1. For suitable applications (see Section 4.2), the central processing system shall send XML and video feeds to the websites publishing the project's information.
2. Raw and processed data shall be formatted and archived according to the construction contract and MassDOT standards.
3. The central processing system shall send alerts to designated personnel (see Section 7.8) when evaluation plan's metrics are deviating from the established thresholds.

## **7.4 Operation of Communications and Power**

1. The SWZ design shall ensure reliable communications, such as sufficient bandwidth during peak periods.
2. The contractor shall ensure the provision of communication services, such as FCC licensing, cellular telephone, wireless data networks, satellite and Internet subscriptions.

## **7.5 Monitoring**

The work zone must be monitored to better understand how construction affects traffic flow and safety, and to help develop work zone policy and planning for future projects. Use the following guidelines for monitoring:

1. Define a monitoring schedule:
  - a) Schedule periodic checks of video and travel time during the work zone regular operation hours.
  - b) Monitor video and travel time continuously during congestion periods and when an incident has occurred.
2. If a traffic incident is detected, notify MassDOT immediately through the established channels.
3. When congestion conditions are detected:
  - a) Determine the cause of congestion and act accordingly (e.g. notify MassDOT of a traffic incident).
  - b) Coordinate with MassDOT to determine whether the construction works must be suspended until flow rates return to normal.
  - c) If construction work must continue, verify that the system is disseminating the appropriate information.
  - d) Determine if the cause and magnitude of congestion deserve overriding automatic messages on dissemination outlets.
  - e) Continue to monitor the situation.
  - f) If in manual message mode, verify that the disseminated information is returned to the automatic mode once the congestion has been cleared.
4. Log other events when detected manually (e.g. traffic incident, queue length and duration).
5. If equipment, systems, communications or power damage or failure is detected, notify MassDOT immediately and follow maintenance procedures.

## **7.6 Data Management & Archiving**

The SWZ will collect, disseminate, and archive data and video. The following guidelines show how to handle data and video, unless otherwise specified in contract documents:



1. Ensure that detection devices send data to the central processing system at least every 60 seconds except when a response action is required immediately (e.g. clearance warning, intrusion warning). In that case, the alarm should be sent upon detection.
2. Ensure that video images are viewable on the web interface at a rate of no less than one frame per second.
3. Ensure that data and messages on PVMS and HMS are updated at least every three minutes except when a response action is required immediately (e.g. clearance warning, intrusion warning). In that case, the message should be sent upon detection.
4. Ensure that data on the SWZ web interface is updated at least every three minutes.
5. Ensure that the XML feed for public websites (project, MassDOT, 511) is updated at least every three minutes.
6. Consolidate, process, and store collected data for all hours that the construction site is in place. Prepare reports for MassDOT in spreadsheet or database format with the data types shown in the following table.

**Table 6: Data to Be Reported to MassDOT**

<b>Data Type</b>	<b>Units</b>	<b>Interval</b>
Travel Time and/or Delay	min	5 minutes
Speed	mph	1 minute
Volume	PCE per unit time	1 minute
Classification	Vehicle class per unit time	1 minute
Capacity	vphpl	1 hour
Queue length	feet	Occurrence
Queue duration	min	Occurrence

7. Consolidate and store collected video with time stamps for all hours that the construction site is in place.
8. Consolidate PVMS, HMS, HAR messages and audible alarms disseminated with time stamps for all hours that the construction site is in place.
9. Submit data and video reports to MassDOT periodically during the construction project. Define submission frequency, format, and medium (e.g. DVD/CD, email) with MassDOT.

## **7.7 System Maintenance**

The contractor must maintain the SWZ elements and repair malfunctions. Conduct the following activities as required:

1. Perform and report maintenance activities during the operation of the SWZ:
  - a) Routine inspection
  - b) Preventive and scheduled maintenance
  - c) Software and firmware updates and upgrades
  - d) System monitoring
  - e) On-site support when failure is detected or reported by MassDOT
  - f) On-call support when requested by MassDOT
2. If any equipment or system malfunctions or is damaged due to crashes, vandalism, adverse weather, etc. conduct the necessary activities to repair/replace the equipment within the time frame specified in the contract.
3. Remove SWZ equipment when work is complete and relocate or reinstall as required by MassDOT and contract documents.

### **7.8 Smart Work Zone Supervisory Chain**

1. The contractor shall be the primary operator of the SWZ and should designate a Local System Manager to serve as the point-of-contact with MassDOT.
2. MassDOT shall designate the SWZ system point(s) of contact for communication on system operation and trouble-shooting efforts.
3. Depending on the project requirements, the SWZ may be required to provide data, and control and monitoring capabilities to the MassDOT traffic engineer, the MassDOT project manager, the MassDOT District Construction Office, MassDOT's Highway Operations Center, and/or other MassDOT offices in downtown Boston.
4. The contractor shall verify with MassDOT the level of access and privileges regarding communications, data feeds, video feeds, alarms and notifications, control of CCTVs, or other connection to the SWZ devices.
5. According to the established privileges, the contractor shall provide access through a web interface (Internet website) with password-controlled levels of control and data access.
6. The contractor, under MassDOT supervision, shall periodically validate the accuracy of collected and published data through various means, such as manual observation of field volumes and probe vehicles to measure travel time and delays.
7. MassDOT shall designate staff to receive and analyze the evaluation plan metrics reports for the application of penalties and incentives.

## 8 REFERENCES

### 8.1 Federal/State Laws and Code

- 23 CFR 630 Subpart J-- Work Zone Safety and Mobility, FHWA  
[http://www.ops.fhwa.dot.gov/wz/resources/final\\_rule.htm](http://www.ops.fhwa.dot.gov/wz/resources/final_rule.htm)
- "Final Rule on Work Zone Safety and Mobility," Federal Highway Administration (FHWA), Effective Date October 12, 2007  
[http://www.ops.fhwa.dot.gov/wz/resources/final\\_rule.htm](http://www.ops.fhwa.dot.gov/wz/resources/final_rule.htm)
- Manual on Uniform Traffic Control Devices (MUTCD), FHWA  
<http://mutcd.fhwa.dot.gov/>
- SAFETEA-LU section 1201, FHWA  
<http://www.fhwa.dot.gov/safetealu/factsheets/realtimesmi.htm>
- Best Practices in Project Delivery Management. NCHRP Domestic Scan Team Report 07-01, Project 20-68A. TRB, National Research Council, Washington, DC. October 2009.  
[http://onlinepubs.trb.org/onlinepubs/nchrp/docs/nchrp20-68a\\_07-01.pdf](http://onlinepubs.trb.org/onlinepubs/nchrp/docs/nchrp20-68a_07-01.pdf)

### 8.2 Design Guidance

- ITS Safety and Mobility Solutions--Improving Travel Through America's Work Zones,  
[http://www.atssa.com/galleries/defaultile/2008July21\\_ITS\\_Safety\\_and\\_Mobility.pdf](http://www.atssa.com/galleries/defaultile/2008July21_ITS_Safety_and_Mobility.pdf)
- MassHighway Standard Details and Drawings for the Development of Temporary Traffic Control Plans, MassDOT  
<http://www.massdot.state.ma.us/portals/8/docs/flaggers/tcp.pdf>
- AASHTO Guidelines For Traffic Data Program, USDOT  
[https://bookstore.transportation.org/item\\_details.aspx?id=1392](https://bookstore.transportation.org/item_details.aspx?id=1392)

### 8.3 Supplemental Documents



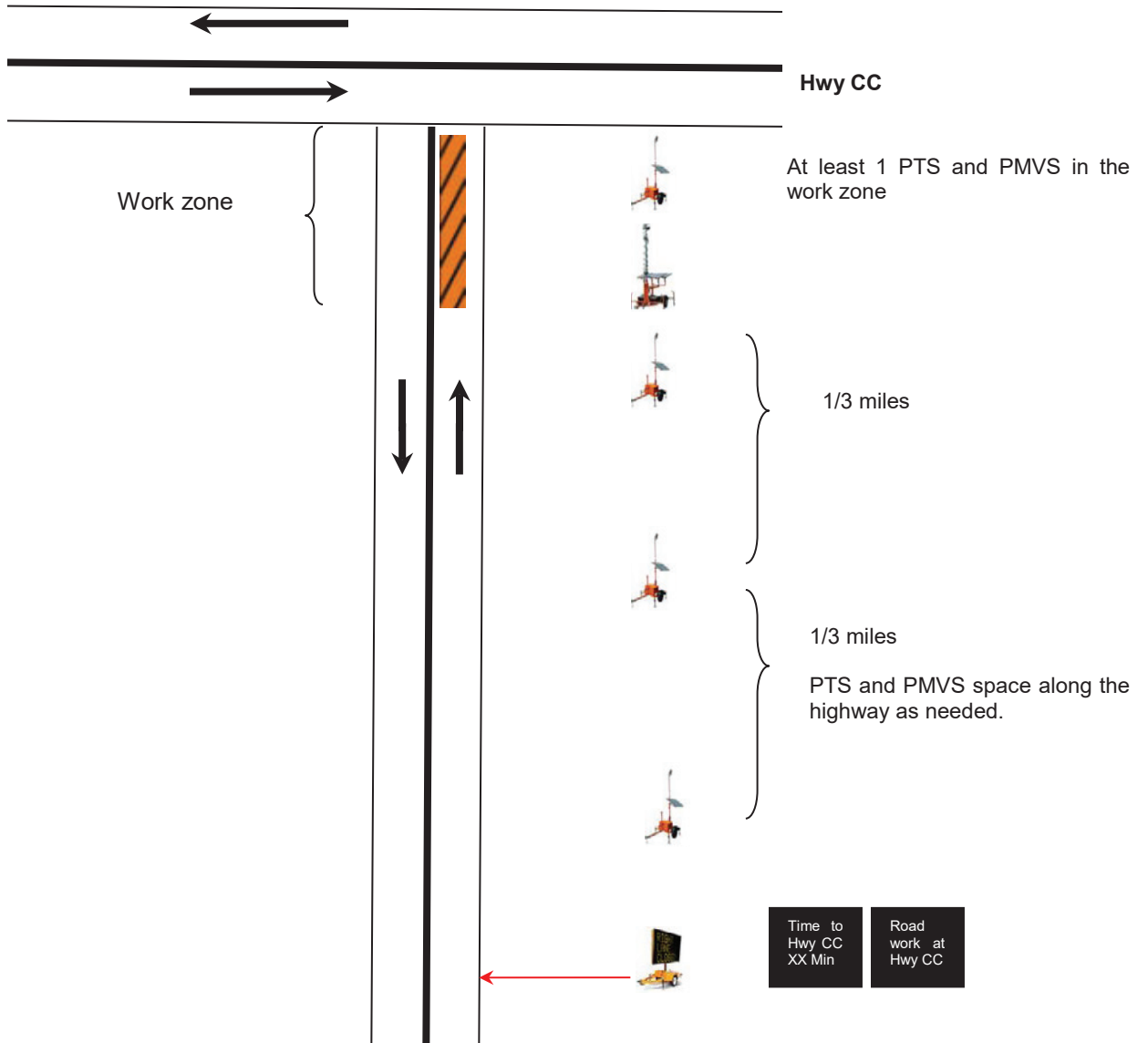

- ITS in Work Zones, FHWA  
[www.ops.fhwa.dot.gov/wz/its/](http://www.ops.fhwa.dot.gov/wz/its/)

- Work Zone Analysis Series, FHWA  
[http://ops.fhwa.dot.gov/wz/traffic\\_analysis/techresources.htm](http://ops.fhwa.dot.gov/wz/traffic_analysis/techresources.htm)
- Work Zone Performance Measures Pilot Test, FHWA  
<http://www.ops.fhwa.dot.gov/wz/resources/publications/fhwahop11022/fhwahop11022.pdf>
- A Primer On Work Zone Safety And Mobility Performance Measurement, FHWA  
<http://www.ops.fhwa.dot.gov/wz/resources/publications/fhwahop11033/fhwahop11033.pdf>
- Work Zone Operations Best Practices Guidebook, FHWA  
<http://www.ops.fhwa.dot.gov/wz/practices/best/bestpractices.htm>
- Minnesota IWZ Toolbox, FHWA  
<http://wwwcf.fhwa.dot.gov/exit.cfm?link=http://www.dot.state.mn.us/trafficeng/workzone/iwz/MN-IWZToolbox.pdf>
- In Case Of Fire--Technology Helps Clear A Path For First Responders  
[http://www.ops.fhwa.dot.gov/wz/resources/news/wznews\\_detail.asp?ID=479](http://www.ops.fhwa.dot.gov/wz/resources/news/wznews_detail.asp?ID=479)
- ITS Deployment and Design Guide June 2011, MassDOT
- Strategic Plan for Massachusetts Statewide Traffic Data Collection and ITS Traffic Monitoring, MassDOT
- IWZ Presentation from ATSSA Conference- February 2008  
<http://wwwcf.fhwa.dot.gov/exit.cfm?link=http://www.dot.state.mn.us/trafficeng/workzone/iwz/PlantingSeedMoney.ppt>

# APPENDIX A. MOBILITY SURVEILLANCE SWZ LAYOUT



## Legend:

-  Portable Traffic Sensor (PTS)
-  Portable Video Cameras System (PMVS)
-  Portable Message Sign (PMS)
-  Construction Zone

## Notes:

1. The above setup is for work zone monitoring and does not replace traffic control devices installed as MUTCD and MassDOT standards.
2. The location of the portable equipment shall not conflict with or obstruct view of any existing and/or proposed permanent and/or temporary traffic control devices.
3. Layouts are not drawn to scale.
4. The number of PTS and PMVS shown above are not accurate but for illustration.

# APPENDIX B. TRAVEL TIME INFORMATION SWZ LAYOUT

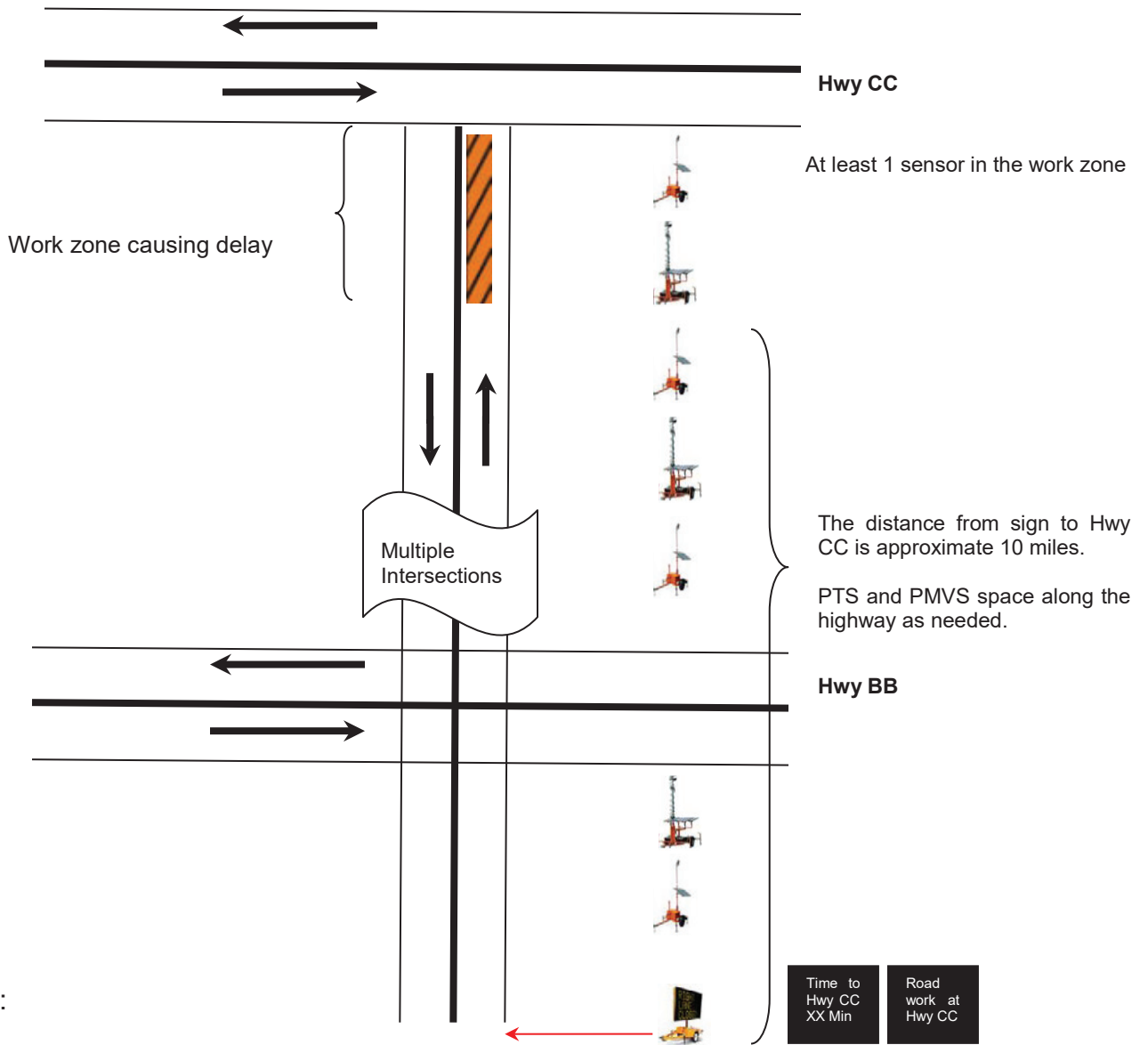

## Legend:

- Portable Traffic Sensor (PTS)
- Portable Video Cameras System (PMVS)
- Portable Message Sign (PMS)
- Construction Zone



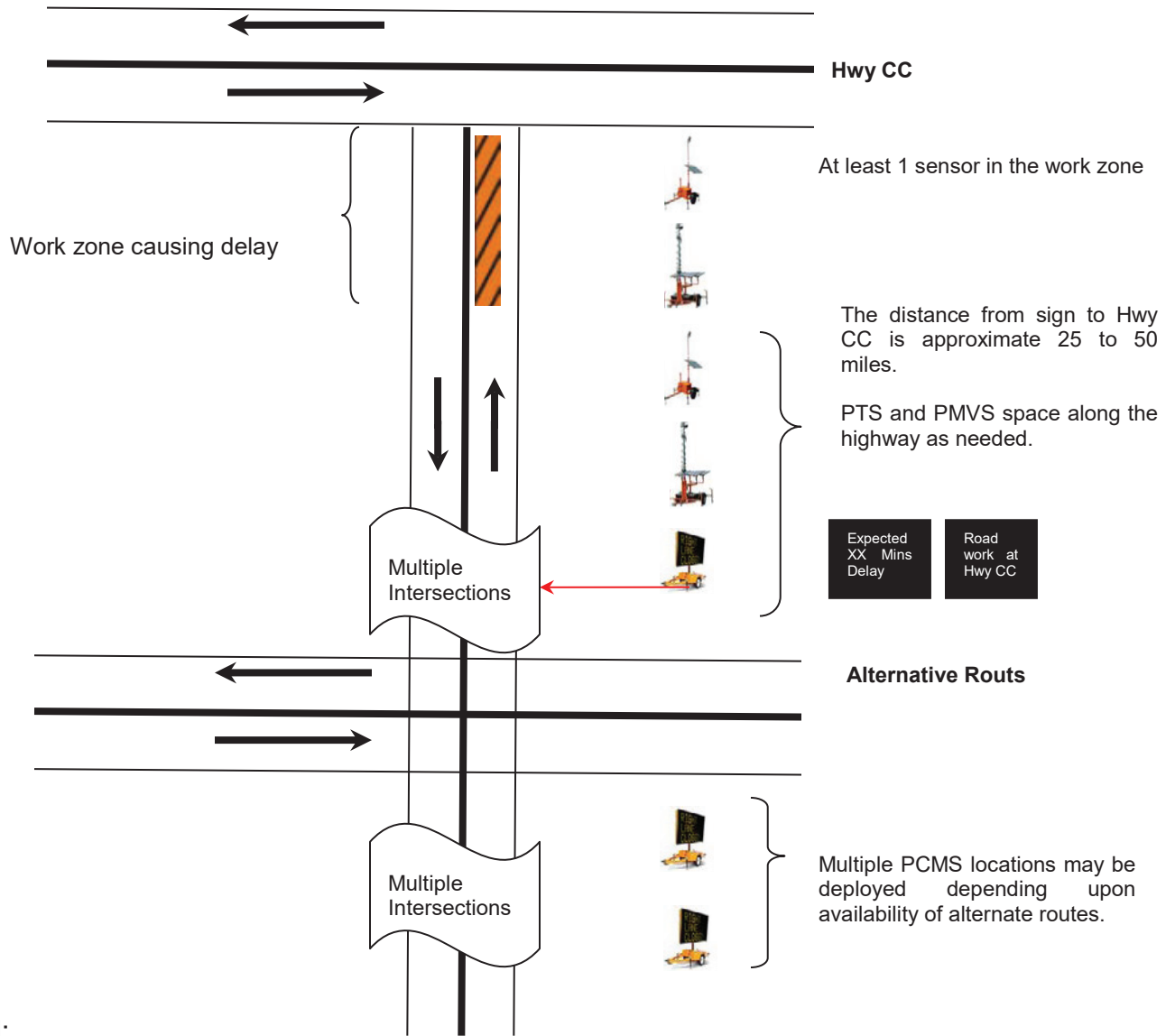

## Notes:

1. The above setup is for work zone monitoring and does not replace traffic control devices installed as MUTCD and MassDOT standards.
2. The location of the portable equipment shall not conflict with or obstruct view of any existing and/or proposed permanent and/or temporary traffic control devices.
3. Layouts are not drawn to scale.
4. The number of PTS and PMVS shown above are not accurate but for illustration.

# APPENDIX C. EXPECTED DELAY INFORMATION SWZ LAYOUT



## Legend:

-  Portable Traffic Sensor (PTS)
-  Portable Video Cameras System (PMVS)
-  Portable Message Sign (PMS)
-  Construction Zone

## Notes:

1. The above setup is for work zone monitoring and does not replace traffic control devices installed as MUTCD and MassDOT standards.
2. The location of the portable equipment shall not conflict with or obstruct view of any existing and/or proposed permanent and/or temporary traffic control devices.
3. Layouts are not drawn to scale.
4. The number of PTS and PMVS shown above are not accurate but for illustration.



# APPENDIX D. STOPPED OR SLOW TRAFFIC SWZ LAYOUT

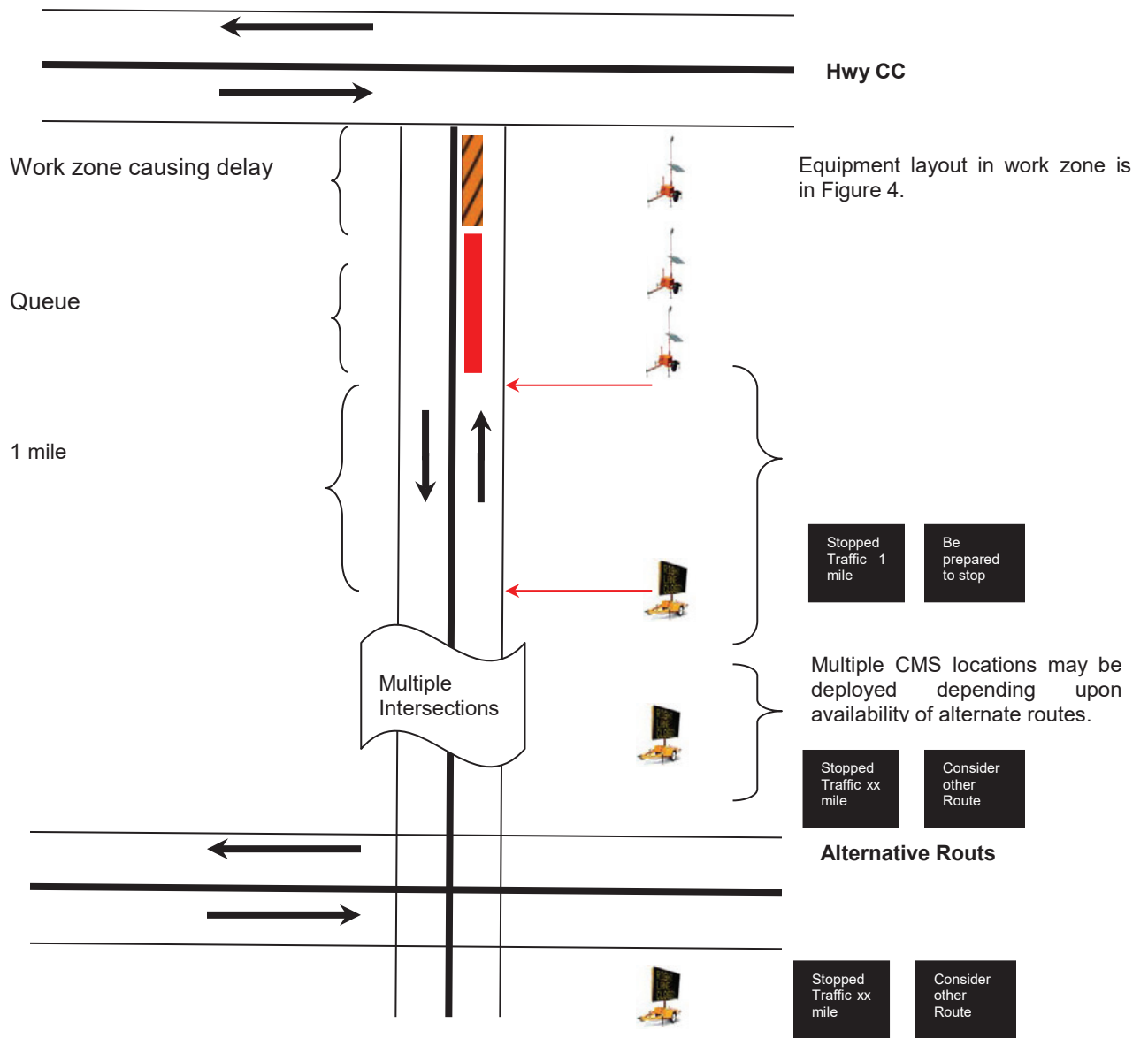

## Legend:

- Portable Traffic Sensor (PTS)
- Portable Video Cameras System (PMVS)
- Portable Message Sign (PMS)
- Construction Zone

## Notes:

1. The above setup is for work zone monitoring and does not replace traffic control devices installed as MUTCD and MassDOT standards.
2. The location of the portable equipment shall not conflict with or obstruct view of any existing and/or proposed permanent and/or temporary traffic control devices.
3. Layouts are not drawn to scale.
4. The number of PTS and PMVS shown above are not accurate but for illustration.
5. When no queue is detected, all the PCMS should be blank unless used for another SWZ system.
6. When the queue extends beyond any PCMS location, the PCMS should be blank, or it may be utilized for another SWZ system.

MassDOT Scoring Criteria for Work Zone ITS	
MassDOT Project Location:	Project #
<b>Base Criteria – Existing Conditions</b>	<u>N/A</u>
• AM Peak Hour Congestion [ Yes - No ] (*if yes estimated duration)	
• PM Peak Hour Congestion [ Yes - No ] (*if yes estimated duration)	
• Congestion in both AM & PM [ Yes - No ] (*if yes estimated duration)	
<b>Factor 1 – Impacts on Roadway Geometry: Permanent Setup or Recurring Short Duration</b>	<u>Score</u>
• Maintain existing cross-section (0 points)	0
• Loss of full shoulder (1 point)	
• Narrowed travel lanes (3 points)	
• Loss of travel lane (6 points)	
• Loss of multiple travel lanes (10 points)	
<b>Factor 2 – Duration of work zone: Long-term stationary work will have a duration of:</b>	<u>Score</u>
• < 6 months (1 points)	0
• 6 - 12 months (4 points)	
• > 1 year (6 points)	
• > 2 years (8 points)	
<b>Factor 3 – Availability of Alternate Routes for detour or diversion of traffic:</b>	<u>Score</u>
• Several alternate routes available with spare capacity (0 points)	0
• Alternate route with spare capacity available (1 points)	
• Alternate route with nominal capacity available (2 points)	
• No viable alternate routes (4 points)	
<b>Factor 4 – Queuing - Anticipated duration of Work Zone Queueing above recurring peak hour conditions are estimated to be:</b>	<u>Score</u>
• < 1 hour per day (3 points)	0
• 1-2 hours per day (5 points)	
• 2 to 4 hours per day (7 points)	
• > 4 hours per day (10 points)	
<b>Factor 5 – Delay Time (Average Delay of vehicles above and beyond existing conditions) <i>Note: use MassDOT WZ Delay Form</i></b>	<u>Score</u>

MassDOT Scoring Criteria for Work Zone ITS	
MassDOT Project Location:	Project #
<ul style="list-style-type: none"> <li>• Delays less than 12 minutes (0 points)</li> <li>• Delays in between 12 to 20 minutes for a duration of 1 hour or more (2 points)</li> <li>• Delays of between 20 to 30 minutes for a duration of 1 hour or more (5 points)</li> <li>• Delays in excess of 30 minutes for a duration at least 2 hours (10 points)</li> </ul>	0
<b>Factor 6 – Commercial Motor Vehicle Traffic Impacts:</b>	<b>Score</b>
<ul style="list-style-type: none"> <li>• Percent Heavy Vehicles &lt;5% (1 point)</li> <li>• Percent Heavy Vehicles 5 -10% (3 points)</li> <li>• Percent Heavy Vehicles &gt;10% (6 points)</li> </ul>	0
<b>Factor 7 – Impacts of Specific Issues (Based on Judgement: No Impact = 0 / Impact = 1)</b>	<b>Score</b>
• Existing Crash History within the Work Zone limits	0
• Traffic Speed Variability	0
• Increased travel time or restricted access to regional traffic generators	0
• Unusual or Unpredictable Weather Patterns Such as Snow, Ice, and Fog	0
• Frequently Changing Operating Conditions for Traffic	0
• Merging Conflicts and Hazards At Work Zone Tapers	0
• Complex Traffic Control Layout with Multiple Access Points (i.e. Ramps or Side Streets)	0
• Construction Vehicle Entry/Exit Speed Differential Relative to Traffic	0
• Limited offset to median or roadside barrier/guardrail	0
• Lane Diversions - Use of Highway Crossover or Center Work Zone	0
<b>Total Project Score</b>	
<b><i>If the total score is:</i></b>	
<ul style="list-style-type: none"> <li>• ≥30 – ITS is likely to provide significant benefits relative to costs for procurement</li> <li>• ≥10 and &lt;30 – ITS may provide some benefits and should be considered as a treatment to mitigate impacts</li> <li>• &lt;10 – ITS may not provide enough benefit as a treatment to justify the associated costs</li> </ul>	0

**Minnesota Department of Transportation**

IWZ Toolbox: Guideline for Intelligent Work Zone System Selection - 2008

<http://www.dot.state.mn.us/trafficeng/workzone/iwz/MN-IWZToolbox.pdf>

Decision Tree to Identify Potential ITS/IWZ Scoping Needs – January 2018

<http://www.dot.state.mn.us/its/docs/scopingdecisiontree.pdf>

# Minnesota IWZ Toolbox

Guideline for  
Intelligent Work Zone  
System Selection

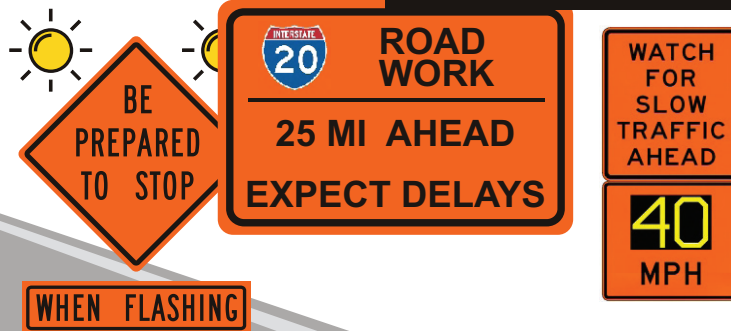

WHEN FLASHING



Written, compiled and illustrated by the  
Minnesota Department of Transportation  
Office of Traffic, Safety, and Operations

MINNESOTA INTELLIGENT WORK ZONE TOOLBOX  
2008 EDITION

this page is intentionally left blank

## ***Introduction:***

The IWZ Toolbox has been prepared as a guideline for selecting an appropriate Intelligent Work Zone (IWZ) System for existing work zone traffic issues and to mitigate anticipated issues on scheduled projects. The IWZ System descriptions contained in this toolbox are intended as brainstorming material and should lead to practical solutions to a project's unique problems. The examples are purposely left void of many dimensions, except where particular distances are highly recommended, and engineering judgement is required to customize the system to a project.

IWZ Systems may be sorted into 3 category types based upon detectable stimuli: "**Traffic**", "**Vehicle**", and "**Environmental**". The 3 categories are shown below with their typically associated systems:

**Traffic Responsive Systems** collect and respond to **average** traffic characteristics such as speed and volume of a group of vehicles and the systems react to **trends** of increasing/decreasing values. The combination of these basic systems form the basis for **Route Management Systems** (or Traveler Information Systems) by analyzing and reporting information in various ways. These applications may include:

- Travel Time Information (Trip Time or Estimated Delay)
- Speed Advisory Information
- Congestion Advisory
- Stopped Traffic Advisory
- Dynamic Merge (Late or Early)
- Traffic Responsive Temporary Signals
- Temporary Ramp Metering

**Vehicle Responsive Systems** collect and respond to **individual** vehicle characteristics such as speed, dimensions, and location. When adverse conditions are detected by these systems, motorist need **immediate warnings** for quick response. These applications may include:

- Excessive Speed Warning (including Dynamic Speed Display Signs)
- Over Dimension Warning
- Work Space / Haul Road Intrusion Warning
- Construction Vehicle Warnings

**Environmentally Responsive Systems** collect and respond to changing non-traffic conditions of weather, roadway or working characteristics such as visibility conditions or roadway surface conditions and hazards. These applications may include:

- Hazardous Condition Warnings (Flooding, Ice, Fog, Smoke, Dust, etc.)

The real-time data collected for any of these systems may be combined, averaged, analyzed for trends, and utilized for several informational uses. For example, data collected for 'Stopped Traffic Warnings' may be to control a 'Dynamic Merge' system or to calculate "Travel Time" through a corridor.

Temporary Traffic Control Devices may be equipped with advanced communication and/or remote control capabilities which that do not react "intelligently" to detectable field data, but the devices provide safer working conditions or improve incident response. Although these devices may not be "Intelligent", they have been included in the IWZ Toolbox as additional safety tools for consideration when an IWZ System is being deployed. These applications may include:

- Changeable Work Zone Signage (WZ Speed Limit Signs)
- Traffic Surveillance Cameras (removed from Toolbox)



### ***Typical System Components:***

Each IWZ System in the Toolbox is a collection of standard system components which have been combined to produce a useful real-time system. The individual component functions include the collection of data, verifying the accuracy of the data, transmitting the data, storing and managing the data, analyzing the data, and/or providing the data to the motorist.

**Detection Components:** The detectors may include:

- Radar
- Pneumatic Road Tubes
- Light Beams
- Acoustical
- Ultrasonic
- Magnetic
- Piezo-Electric
- Video
- RFID
- Probe Injection Technologies, etc.

**System Monitoring Components:** typical redundancies should be built into most systems (based upon risk assessment for the system failure) and the various types of quality control testing or system monitoring may be utilized.

**System Communication Components:** the typical forms of transmitting data, some of these may include:

- Cell Phones
- Internet - Wireless Access Points
- Radio
- Hard wired
- Optical, etc.

**System Analysis Components:** analysis algorithms are designed or modified for each application of an IWZ System to fit the conditions of the project. Algorithms can be designed with apparent limitations and strengths, and field testing is necessary to ensure the quality of the data analysis.

**Data Management Components:** the storage of data and analysis of the data for various trends, events, etc. may utilize many different database systems.

**Dynamic Informational Components:** dynamic components provide information to the motorists and may include:

- 511 Systems (internet & phone/cell phone),
- Changeable message signs (CMS) in dynamic mode,
- Static signs with dynamic features,
- Remotely activated traffic control devices,
- Audible or visual alarms,
- Real-time highway advisory radio (HAR),
- Public media announcements,
- CB Radio, etc.

---

### ***Supplementing Existing System Components:***







Mn/DOT, through its Regional Transportation Management Center (RTMC) and out-state TOCC's, has the capability to provide a variety of IWZ Systems for Mn/DOT construction and maintenance projects. However, Mn/DOT's detection devices, communications networks or traveler information systems may not be adequate for a proposed IWZ System. Discrepancies may be due to construction interrupting permanent installations, or that the existing system components do not extend to the project area.

IWZ System components provided by a contractor would supplement the services of the RTMC or TOCC's, when various devices/services are not currently available and may include any of the component types listed above.

## DEFINITIONS FOR USE IN THIS DOCUMENT

- **Changeable Message Sign (CMS):** a sign that is capable of displaying more than one message, changeable manually, by remote control, or by automatic control. The device is considered "portable" when trailer mounted. The device may be operated in one of two modes:
  - **Standard Mode:** message is programmed to remain displayed until changed by the operator or via a timer.
  - **Dynamic Mode:** the message is programmed to respond to traffic operating characteristics or roadway conditions.
- **Static Sign:** a message for the motorist is printed on a standard sign, either regulatory, warning or guide signs.
- **Advisory Speed:** a recommended speed for vehicles based on the current roadway conditions or operating characteristics. Advisory Speeds are not enforceable.
- **Speed Limit:** the speed applicable to a section of highway as established by law.
- **Travel Time:** the estimated amount of drive time from the motorist's current location to an identified location, generally limited to approx 10 miles maximum distance.
- **Travel Delay:** the estimated amount of extra time the motorist will incur due to traffic conditions in a work zone located downstream. Generally useful for spot locations at a great distance away from the motorist's current location, which provides alternate route possibilities.
- **Devices (components):** the individual parts or subsystems that makeup a working IWZ System. Examples include: cameras, various detectors, signs, data monitoring or recording equipment, communication systems, TTC devices, and remotely activated alarms, etc.
- **IWZ System:** An automated system of devices that provides motorists and/or workers **real-time** information for improved safety and mobility through a work zone. The devices are integrated to monitor traffic operating characteristics or roadway conditions and react with a predetermined response.
- **Warrants:** conditions which should be satisfied before considering an IWZ system for deployment as part of a project's temporary traffic control plan.
- **Benefits:** anticipated affects mobility and safety when the system is properly designed and deployed. Mobility and safety measures may be within the work zone or surrounding network, and may include the public, the workers, or the constructability of the project.
- **Options:** various options may be available for portions of the IWZ Systems. The options should be considered when they achieve satisfactory results with lower levels of 'system complication' and cost.

## SYMBOLS USED IN IWZ TOOLBOX ILLUSTRATIONS

- 
  - **Changeable Message Sign (CMS):** Roadside location symbol shown on left with an example of two alternating messages shown on right.
- 
  - **Static Guide Sign:** Roadside location symbol shown on left with example message shown on right.
- 
  - **Static Guide Sign with CMS Characters:** Roadside location symbol shown on left with example message shown on right.
- 
  - **Dynamic Flashing Warning Sign:** Roadside location symbol shown on left with example message shown on right.
- 
  - **Non-Intrusive Detection Device:** The symbol denotes any type of detection device(s) and the actual location and number of devices will vary from the toolbox illustration.
- 
  - **Advance Warning Sign:** Roadside location symbol shown on left with example message shown on right.
- 
  - **Temporary Traffic Control (TTC) Device:** The symbols denote standard TTC devices as defined by the MN MUTCD and the Field Manual of TTC Layouts. To highlight the IWZ systems, only a minimal amount of TTC devices have been shown on the toolbox illustrations. Key devices shown may include standard warning signs, Type III barricades, channelizing devices and flashing arrow panels.

## GENERAL IWZ TOOLBOX NOTES

- Advance warning signs and other standard temporary traffic control devices have not been shown on this figure. Refer to the MN MUTCD including the 2007 Field Manual or the TTC Layout Templates for typical layout examples.
- All IWZ Guide Signs and CMS should be reviewed by the Mn/DOT Office of Traffic, Safety, & Operations for design and message approval.
- Approved CMS messages should be listed in the Special Provisions, and approx CMS locations should shown on the TTC plans. All CMS displays should be blank when messages are not warranted.
- Refer to the Toolbox Definitions Section for graphic symbols and terms.
- Toolbox Illustrations are NOT Drawn to Scale.

## IWZ SYSTEMS LISTED IN THIS PUBLICATION

- **Travel Time Information - Trip Time or Estimated Delay**
- **Speed Advisory Information**
- **Congestion Advisory**
- **Stopped Traffic Advisory**
- **Dynamic Merge - Late or Early**
- **Traffic Responsive Temporary Signals**
- **Temporary Ramp Metering**
- **Excessive Speed Warning - incl. Dynamic Speed Display Signs**
- **Over Dimension Warning**
- **Work Space / Haul Road Intrusion Warning**
- **Construction Vehicle Warnings - Merging, Crossing & Exiting**
- **Hazardous Condition Warnings - Road Surface or Visibility**
- **Changeable Work Zone Signage - incl. WZ Speed Limits**
- 

**Note:** The IWZ Toolbox Sheets contained within this document are preliminary illustrations and may not accurately represent all the IWZ Systems as typically deployed.

The systems may be combined, modified, enhanced or simplified as necessary for a particular project. Please use these toolbox sheets to brainstorm IWZ possibilities, and consider what conditions may be needed to make the application viable. When a system is deployed, we hope to quantify these conditions further, with refined warrants on the system's toolbox sheet. We also wish to quantify benefits derived from the deployments where ever possible in addition to the intuitive benefits that may be reaped from the IWZ systems.

**WARRANTS**

- The work zone may cause 15 minutes or more of additional travel time.
- The work zone causing the delay is within 10 miles of the CMS location.

**BENEFITS**

- The system should inform the drivers what the estimated travel time is between their current location and a specific destination beyond them (up to 10 miles maximum).
- The system will give drivers information which will allow them to decide whether to change routes, provide them opportunity to notify others of their estimated arrival time, and generally provide drivers sufficient information to calm tempers.

Layouts are NOT drawn to scale.

**ESTIMATED TRIP TIME**

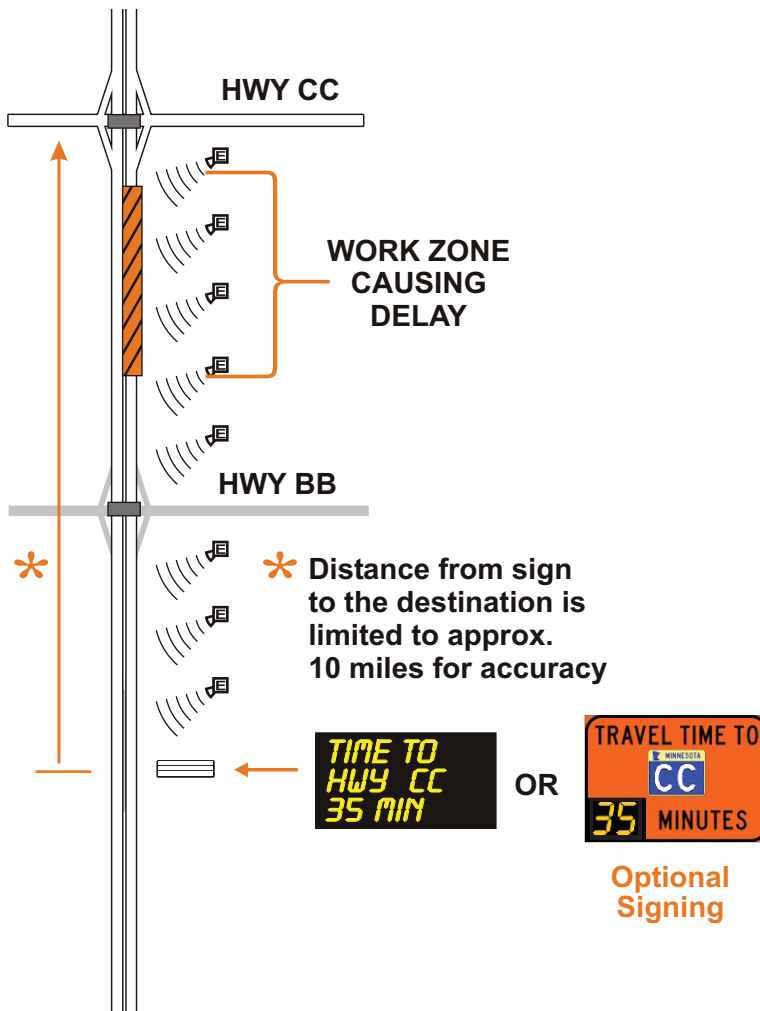

Consideration should be given to posting an alternate route and travel time for additional driver information.

**OPTIONS**

- The CMS may be replaced with static warning signs equipped with two (2) CMS characters in dynamic mode. The characters would display the real-time travel time in the work zone downstream.
- Consideration should be given to posting an alternate route and travel time for additional driver information.
- The CMS may be supplemented with other informational devices such as Highway Advisory Radio (HAR).



**NOTES**

- Advance warning signs and other standard temporary traffic control devices have not been shown on this figure. Refer to the MN MUTCD including the 2007 Field Manual or the TTC Layout Templates for typical layout examples.
- All IWZ Guide Signs and CMS should be reviewed by the Mn/DOT Office of Traffic, Safety, & Operations for design and message approval.
- Approved CMS messages should be listed in the Special Provisions, and approx CMS locations should shown on the TTC plans. All CMS displays should be blank when messages are not warranted.
- Refer to the Toolbox Definitions Section for graphic symbols and terms.

## WARRANTS

- The work zone may cause 15 minutes or more of additional travel time.
- The work zone causing the delay is located more than 10 miles beyond the CMS location (preferably 25 to 50 miles or more, such that multiple alternate routes are available).

## BENEFITS

- System should inform the drivers what the estimated delay time is at an approximate location along the roadway downstream. The delay is calculated based upon queue speeds vs. normal travel speeds.
- The system will give drivers information which will allow them to decide whether to change routes, provide them opportunity to notify others of their estimated arrival time, and generally provides drivers sufficient information to calm tempers when they arrive at the cause of the delay.

Layouts are NOT drawn to scale.

## ESTIMATED DELAY TIME

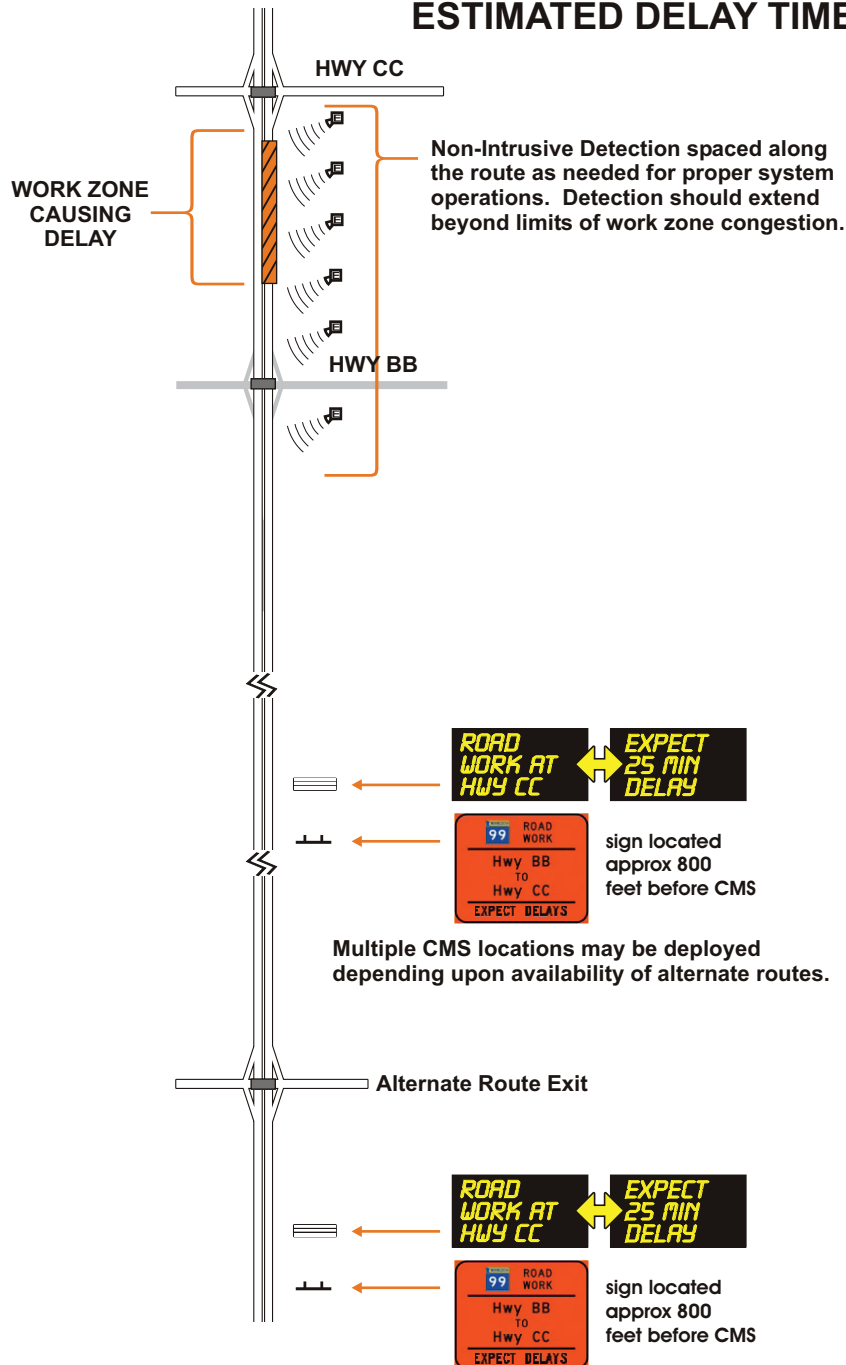

## OPTIONS

- The CMS may be replaced with static warning signs equipped with two (2) CMS characters in dynamic mode. The characters would display the real-time travel delay in the work zone downstream.
- Consideration should be given to posting an alternate route and travel time for additional driver information.
- The system may be converted to a Travel Time system within 10 miles of the destination location (such as Hwy CC in this example).
- The CMS may be supplemented with other informational devices such as Highway Advisory Radio (HAR).



## NOTES

- Advance warning signs and other standard temporary traffic control devices have not been shown on this figure. Refer to the MN MUTCD including the 2007 Field Manual or the TTC Layout Templates for typical layout examples.
- All IWZ Guide Signs and CMS should be reviewed by the Mn/DOT Office of Traffic, Safety, & Operations for design and message approval.
- Approved CMS messages should be listed in the Special Provisions, and approx CMS locations should shown on the TTC plans. All CMS displays should be blank when messages are not warranted.
- Refer to the Toolbox Definitions Section for graphic symbols and terms.



## WARRANTS

- The work zone will cause additional travel time.
- The work zone queue is estimated to slow traffic at least 20 mph below the posted speed limit.

## BENEFITS

- The system should advise drivers of an appropriate vehicle speed to allow them to travel through the work zone with minimal braking.
- The system will smooth the transition between faster and slower moving traffic.
- The system should provide an increase in capacity of the roadway through the work zone area.

Layouts are NOT drawn to scale.

## OPTIONS

- The CMS may be replaced with static warning signs equipped with two (2) CMS characters in dynamic mode. The characters would display the real-time average speed in the work zone downstream.

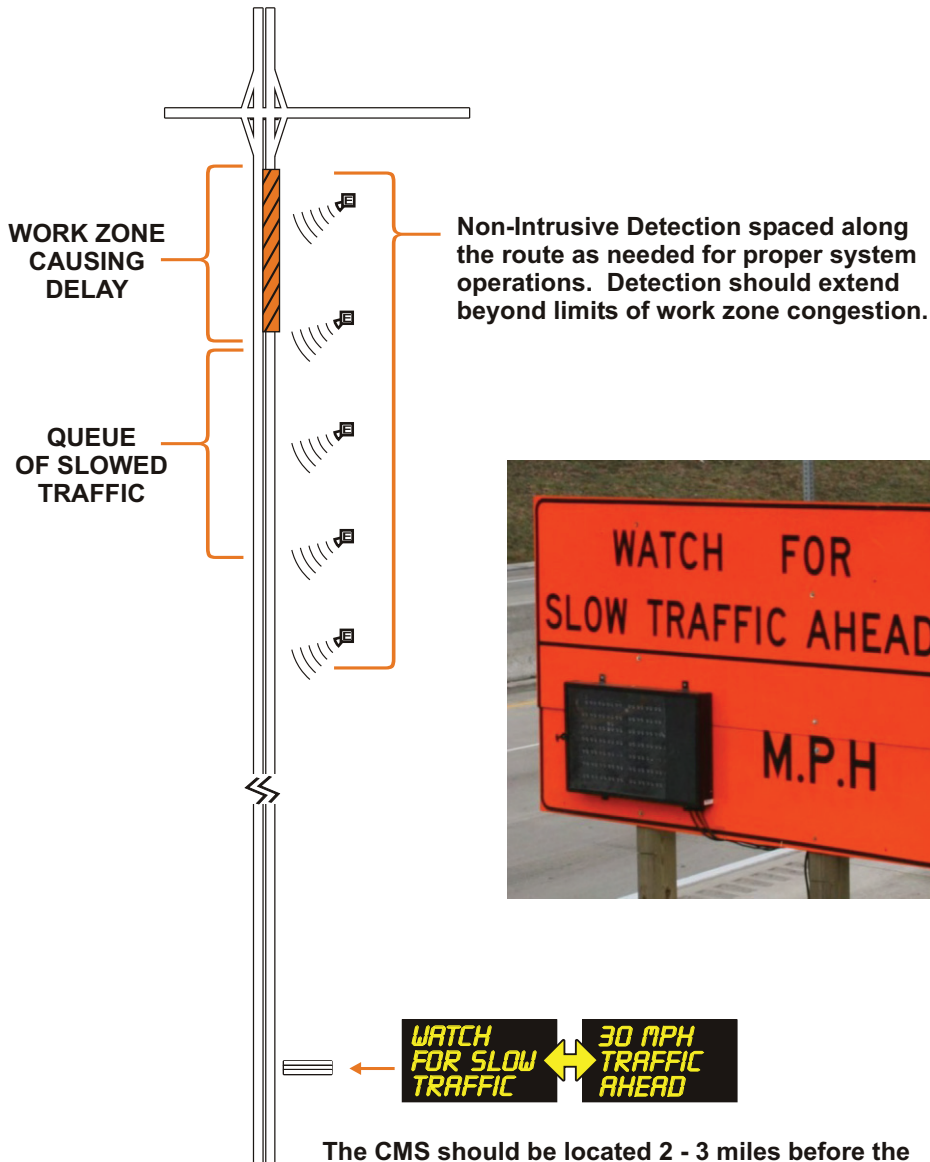

The CMS should be located 2 - 3 miles before the slow traffic queue. The displayed speed is the average speed detected entering the work zone location. Based on this information, the motorist may adjust speed to anticipate the slower traffic.

**OPTIONAL DESIGN:**  
combination of static sign and digital number display



## NOTES

- Advance warning signs and other standard temporary traffic control devices have not been shown on this figure. Refer to the MN MUTCD including the 2007 Field Manual or the TTC Layout Templates for typical layout examples.
- All IWZ Guide Signs and CMS should be reviewed by the Mn/DOT Office of Traffic, Safety, & Operations for design and message approval.
- Approved CMS messages should be listed in the Special Provisions, and approx CMS locations should shown on the TTC plans. All CMS displays should be blank when messages are not warranted.
- Refer to the Toolbox Definitions Section for graphic symbols and terms.

## WARRANTS

- Queue lengths are estimated to vary greatly, day-by-day and hour-by-hour such that a suitable location for the TTC advance warning signage can not be predicted. Note: signs placed more than a mile ahead of confirmation are typically forgotten by the motorist.
- Queue lengths may encroach upstream beyond a motorist's reasonable expectations for stopped traffic and there is probability that the geometrics (terrain) may cause poor visibility of end of traffic queues, causing short reaction times and panic stopping.
- The queue is estimated to stop downstream of the last CMS in the system.

## BENEFITS

- The system should alert drivers of an upcoming traffic slow-down or stopped traffic, providing time to determine possible route alternates, and to be prepared to stop safely.
- Traffic may divert to alternate routes.

Layouts are NOT drawn to scale.

## OPTIONS

- When queues are estimated to never extend to the CMS location, the CMS may be replaced with a static warning sign equipped with two dynamic CMS characters for mileage. When no queues are detected, the mileage display would correspond with the accompanying guide sign for "Road Work XX Mi Ahead".



- When traffic queue lengths are reasonably predictable, warning motorists of stopped / slowed traffic may be accomplished with the use of typical TTC warning signs placed prior to the anticipated beginning of queue.
- The system may be combined with "Dynamic Merge", "Stopped Traffic Warning" and "Travel Time and/or Delay" systems.

## NOTES

- Advance warning signs and other standard temporary traffic control devices have not been shown on this figure. Refer to the MN MUTCD including the 2007 Field Manual or the TTC Layout Templates for typical layout examples.
- All IWZ Guide Signs and CMS should be reviewed by the Mn/DOT Office of Traffic, Safety, & Operations for design and message approval.
- Approved CMS messages should be listed in the Special Provisions, and approx CMS locations should shown on the TTC plans. All CMS displays should be blank when messages are not warranted.
- Refer to the Toolbox Definitions Section for graphic symbols and terms.

## OPERATIONAL NOTES:

- When no queue is detected, all the CMS should be blank unless used for another IWZ system.
- When the queue approaches within one mile of any CMS, the CMS should operate as a "Stopped Traffic Advisory" device.
- When the queue extends beyond any CMS location, the CMS should be blank, or it may be utilized for another IWZ system such as DLM.

Non-Intrusive Detection spaced along the route as needed for proper system operations

Queue length for this example (4 miles)

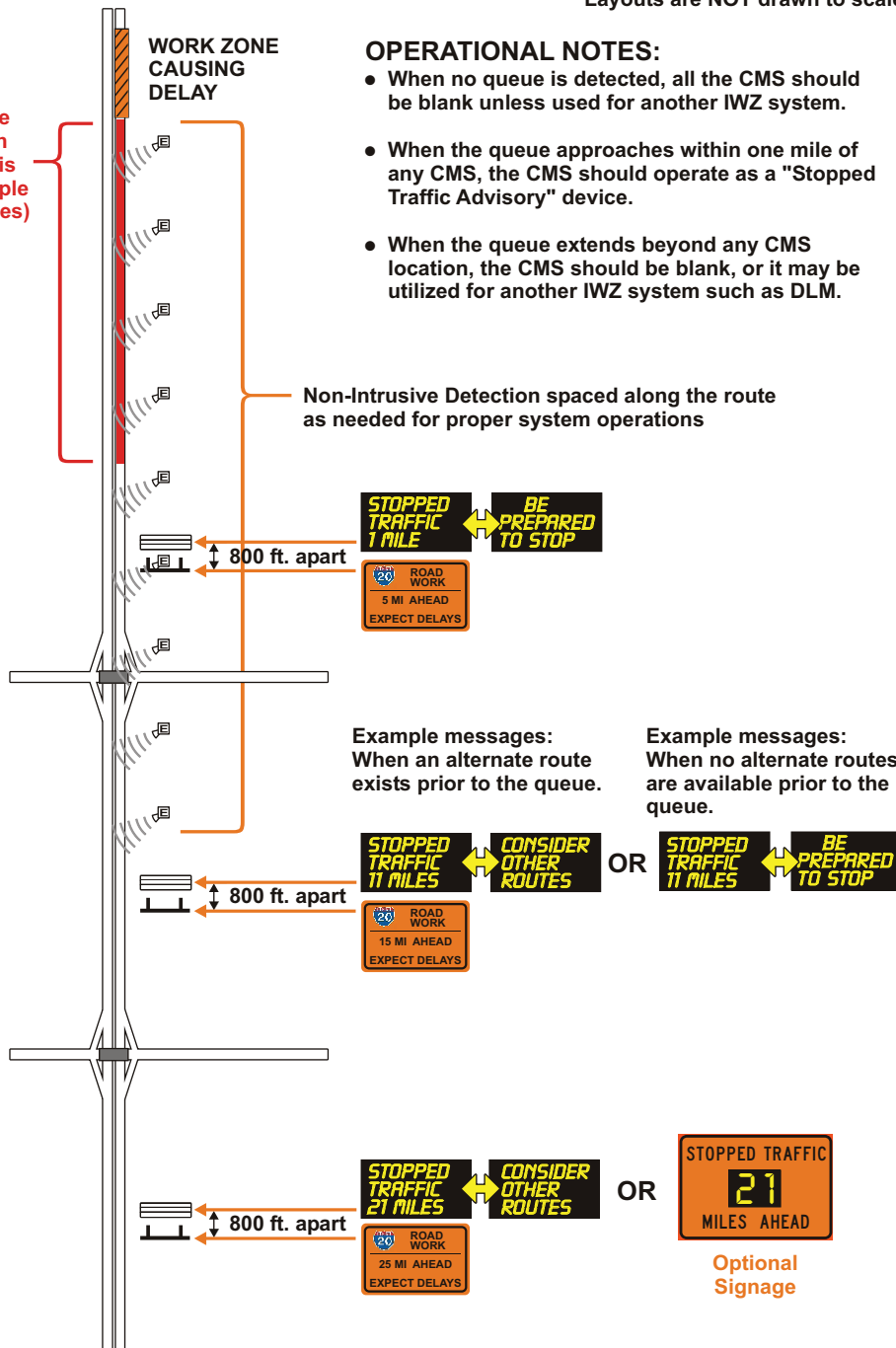

Example messages:  
When an alternate route exists prior to the queue.

Example messages:  
When no alternate routes are available prior to the queue.



## WARRANTS

- Queue lengths are estimated to vary greatly, day-by-day and hour-by-hour such that a suitable location for the TTC advance warning signage can not be predicted. Note: signs placed more than a mile ahead of confirmation are typically forgotten by the motorist.
- Queue lengths may encroach upstream beyond a motorist's reasonable expectations for stopped traffic and there is probability that the geometrics (terrain) may cause poor visibility of end of traffic queues, causing short reaction times and panic stopping.
- Queues initiated on crossroads are estimated to cause traffic conflicts and/or delays on the mainline road, such as backups beyond the length of ramps, through or around turns in intersections, or other hazardous congestion situations.

## BENEFITS

- The system should alert drivers of an upcoming traffic slow-down or stopped traffic, providing time to determine possible route alternates, and to be prepared to stop safely.
- It is anticipated that the system will reduce rear-end crashes.
- Traffic may divert to alternate routes.

Layouts are NOT drawn to scale.

## OPTIONS

- The CMS may be replaced with an appropriate warning sign equipped with dynamically automated flashing lights as shown below.
- The static signs are spaced incrementally and the individual flashers are activated in response to queued traffic when the queue is detected within one mile of the sign location.



OPTIONAL SIGN DESIGN

- When traffic queue lengths are reasonably predictable, warning motorists of stopped / slowed traffic may be accomplished with the use of typical TTC warning signs placed prior to the anticipated beginning of queue.
- The system may be combined with "Dynamic Merge" and "Stopped Traffic Advisory" systems

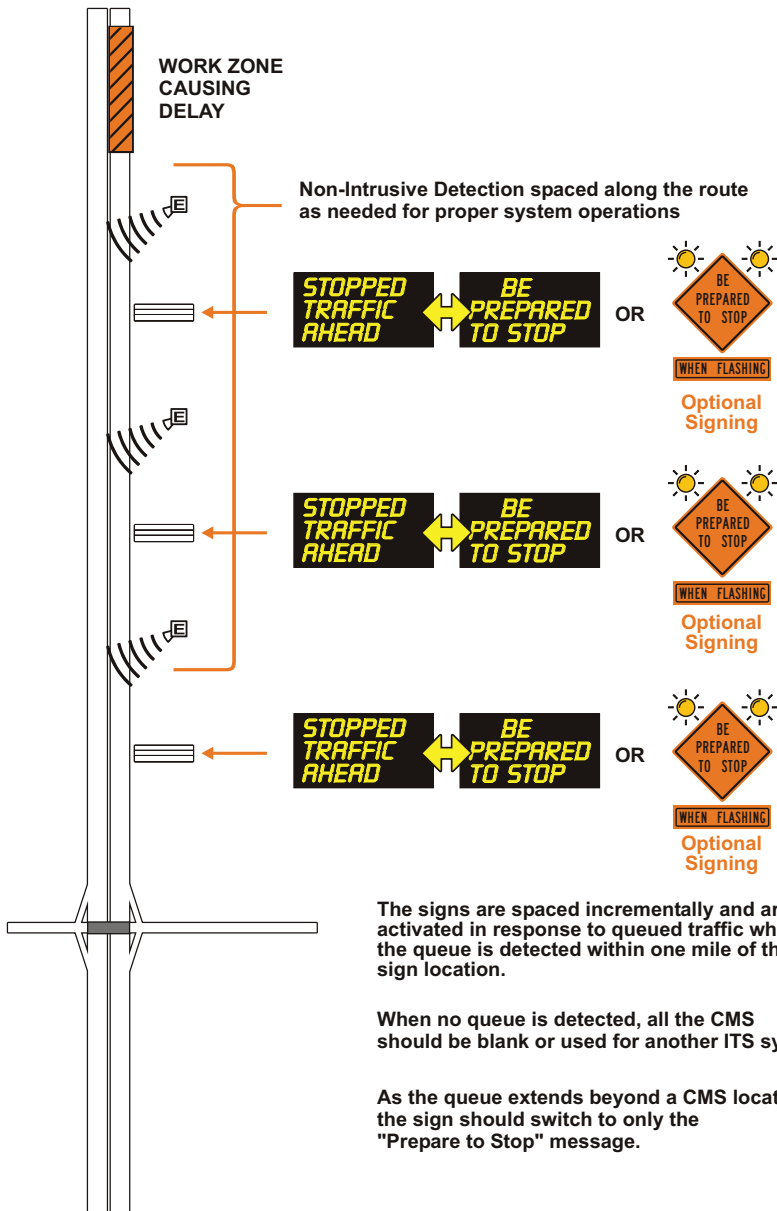

## NOTES

- Advance warning signs and other standard temporary traffic control devices have not been shown on this figure. Refer to the MN MUTCD including the 2007 Field Manual or the TTC Layout Templates for typical layout examples.
- All IWZ Guide Signs and CMS should be reviewed by the Mn/DOT Office of Traffic, Safety, & Operations for design and message approval.
- Approved CMS messages should be listed in the Special Provisions, and approx CMS locations should shown on the TTC plans. All CMS displays should be blank when messages are not warranted.
- Refer to the Toolbox Definitions Section for graphic symbols and terms.

## WARRANTS

- Two lanes of must merge into one direction will be closed to traffic and traffic must merge.
- Although queues may develop at low volumes for many reasons, typically, the volume must exceed 1500 vehicles/hour to sustain a queue that was caused by merging lanes.
- Estimated queue lengths may encroach beyond an upstream intersection or interchange operations.
- The speeds and lane occupancy volumes are anticipated to vary unpredictably causing the motorist to have trouble identifying the best lane usage practice, such as using both lanes versus moving into the continuous thru-lane.

## BENEFITS

- The system should alert drivers of an upcoming traffic slow-down or stopped traffic, and inform them to use both lanes until the designated merge point.
- It is anticipated that the system will reduce the length of the upstream queue by 40%, which may reduce conflicts at nearby intersections.
- By utilizing both traffic lanes, the differential speed between lanes is greatly reduced since both lanes travel at approx the same speed.
- Motorists are given positive directions on lane usage and merging which clears misunderstandings between drivers and reduces road rage.

Layouts are NOT drawn to scale.

## OPTIONS

- The dynamic system may be combined with Congestion Warning and Travel Time and/or Delay Systems.
- When the speeds and lane occupancy volumes are anticipated to increase very predictably and hold at that a high level, the motorist should have little trouble identifying when the traffic is congesting and begin to follow the posted merging procedure, such as using both lanes. Only clear directions on proper actions are needed by the motorist. Two options:

- The directions may be supplied on static guide signs posted beyond the anticipated queue length and repeated within the queue area. An example series of **Static Signs** is shown below:

**ROAD WORK  
15 MILES AHEAD  
EXPECT LONG BACKUPS  
ON WEEKENDS**

**DURING BACKUPS  
USE BOTH LANES  
TAKE TURNS AT MERGE**

- When the congestion time is highly predictable, the directions may be posted on CMS as shown in the illustration, and activated by timers, rather than traffic conditions.

- When traffic queue lengths are reasonably low and predictable, instructing motorists of proper lane usage may be accomplished with the use of typical TTC warning signs placed prior to the anticipated beginning of queue.

## NOTES

- Advance warning signs and other standard temporary traffic control devices have not been shown on this figure. Refer to the MN MUTCD including the 2007 Field Manual or the TTC Layout Templates for typical layout examples.
- All IWZ Guide Signs and CMS should be reviewed by the Mn/DOT Office of Traffic, Safety, & Operations for design and message approval.
- Approved CMS messages should be listed in the Special Provisions, and approx CMS locations should shown on the TTC plans. All CMS displays should be blank when messages are not warranted.
- Refer to the Toolbox Definitions Section for graphic symbols and terms.

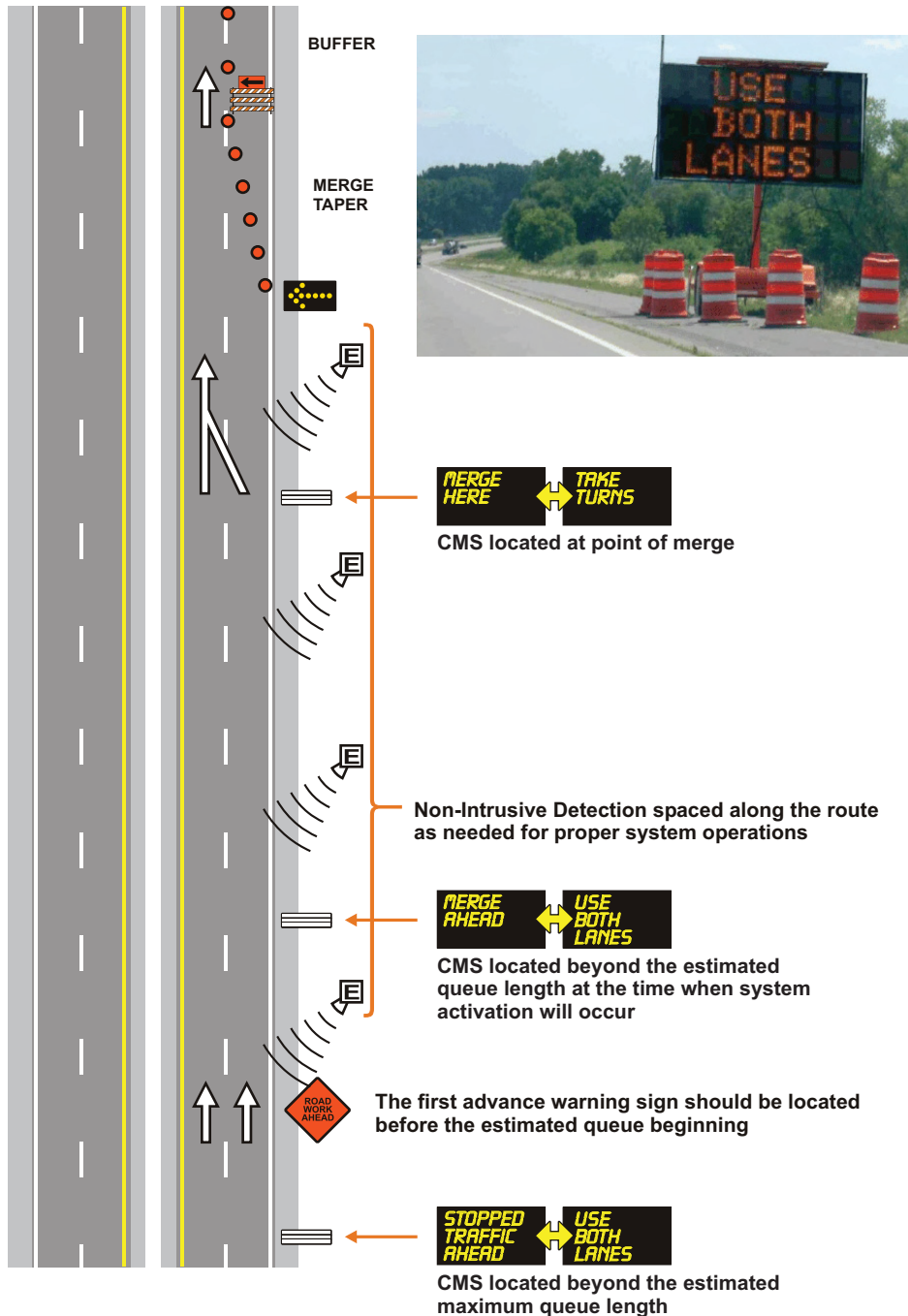

**WARRANTS**

**BENEFITS**

# SHEET UNDER DEVELOPMENT

Layouts are NOT drawn to scale.

**OPTIONS**

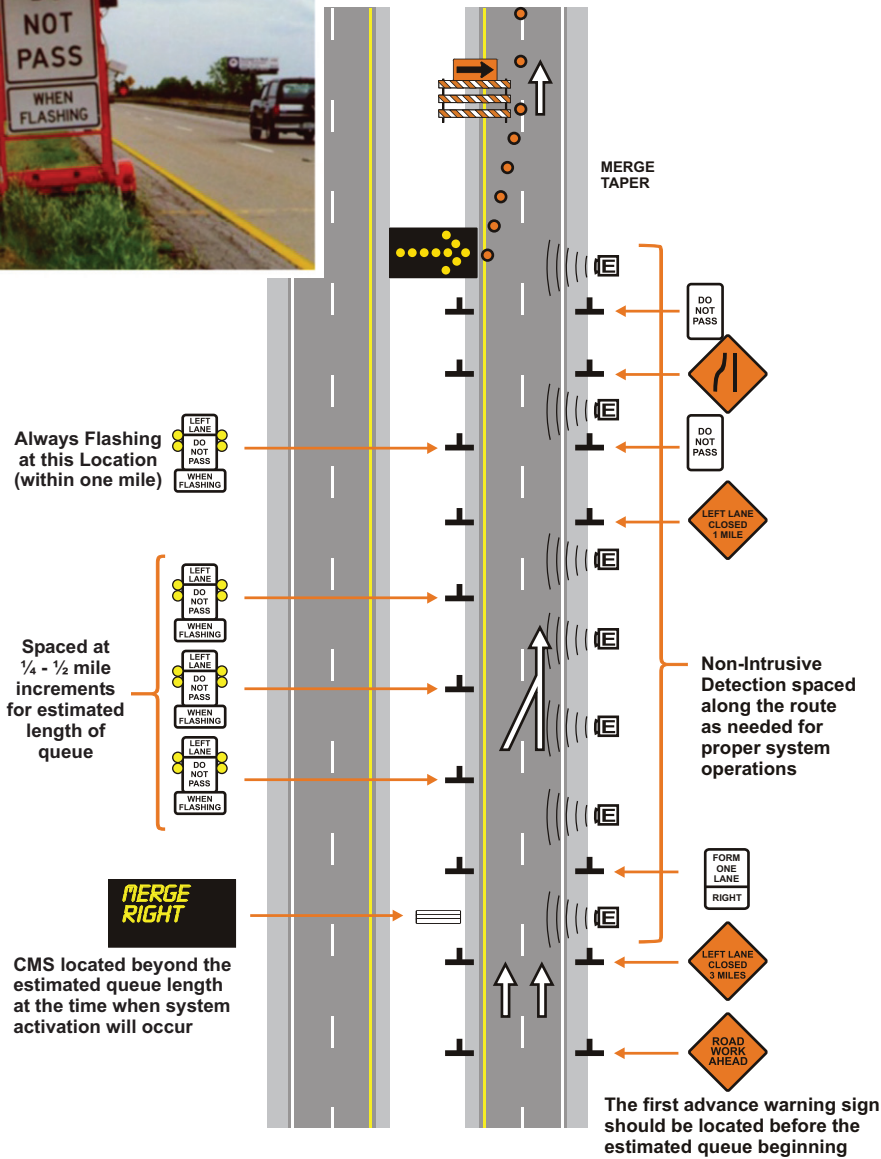

**NOTES**

- Advance warning signs and other standard temporary traffic control devices have not been shown on this figure. Refer to the MN MUTCD including the 2007 Field Manual or the TTC Layout Templates for typical layout examples.
- All IWZ Guide Signs and CMS should be reviewed by the Mn/DOT Office of Traffic, Safety, & Operations for design and message approval.
- Approved CMS messages should be listed in the Special Provisions, and approx CMS locations should shown on the TTC plans. All CMS displays should be blank when messages are not warranted.
- Refer to the Toolbox Definitions Section for graphic symbols and terms.

**WARRANTS**

•

**BENEFITS**

•

Layouts are NOT drawn to scale.

**OPTIONS**

**SHEET UNDER DEVELOPMENT**

**NOTES**

- Advance warning signs and other standard temporary traffic control devices have not been shown on this figure. Refer to the MN MUTCD including the 2007 Field Manual or the TTC Layout Templates for typical layout examples.
- All IWZ Guide Signs and CMS should be reviewed by the Mn/DOT Office of Traffic, Safety, & Operations for design and message approval.
- Approved CMS messages should be listed in the Special Provisions, and approx CMS locations should shown on the TTC plans. All CMS displays should be blank when messages are not warranted.
- Refer to the Toolbox Definitions Section for graphic symbols and terms.



**TRAFFIC RESPONSIVE**

**TRAFFIC RESPONSIVE TEMPORARY SIGNALS**

Last Revision Date: 10-01-07

WARRANTS

BENEFITS

# SHEET UNDER DEVELOPMENT

Layouts are NOT drawn to scale.

OPTIONS

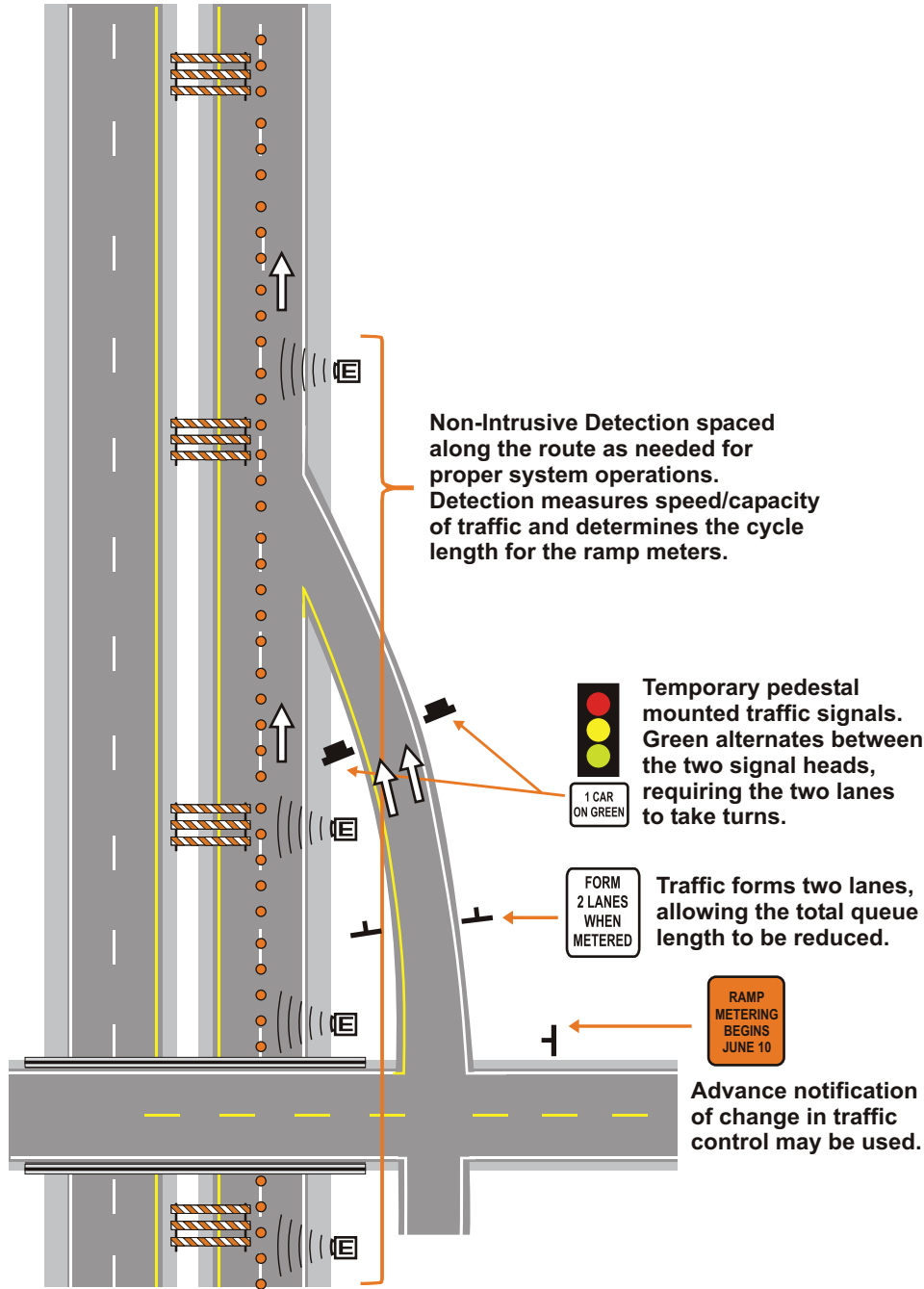

### NOTES

- Advance warning signs and other standard temporary traffic control devices have not been shown on this figure. Refer to the MN MUTCD including the 2007 Field Manual or the TTC Layout Templates for typical layout examples.
- All IWZ Guide Signs and CMS should be reviewed by the Mn/DOT Office of Traffic, Safety, & Operations for design and message approval.
- Approved CMS messages should be listed in the Special Provisions, and approx CMS locations should shown on the TTC plans. All CMS displays should be blank when messages are not warranted.
- Refer to the Toolbox Definitions Section for graphic symbols and terms.

**WARRANTS**

- Traffic must reduce speed to safety negotiate a hazardous condition such as a temporary unusually tight curve, or a rough road surface.
- Buffer spaces and/or clear-zones should be analyzed for possible intrusions by vehicles unable to sufficiently slow down in time.

**BENEFITS**

- System should alert a driver that they have inadvertently entered a portion of the work zone at a speed substantially above the advisory speed limit.
- The system provides sufficient time to slow down for the hazardous condition.

Layouts are NOT drawn to scale.

**OPTIONS**

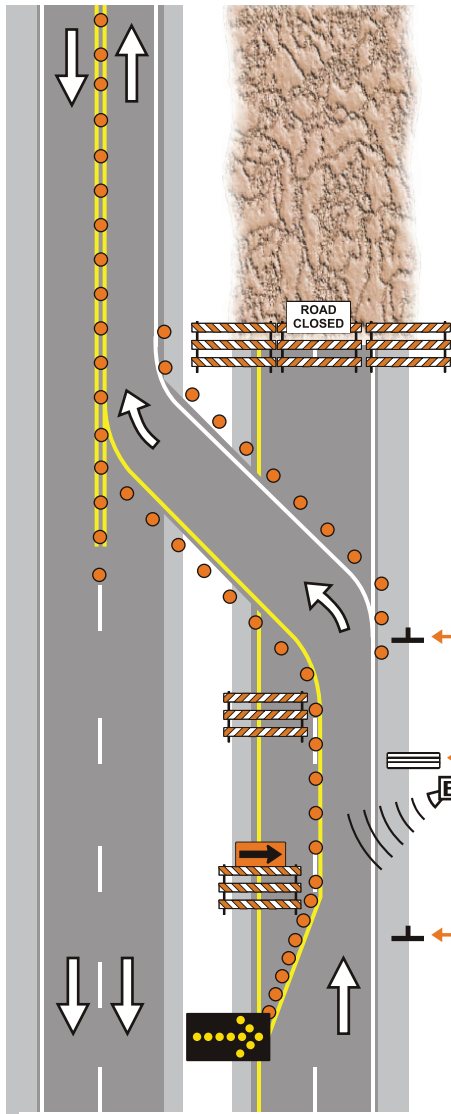

Example shows a reduced advisory speed limit due to sharp curve with either a substandard clear zone or inadequate buffer zone for errant vehicles.

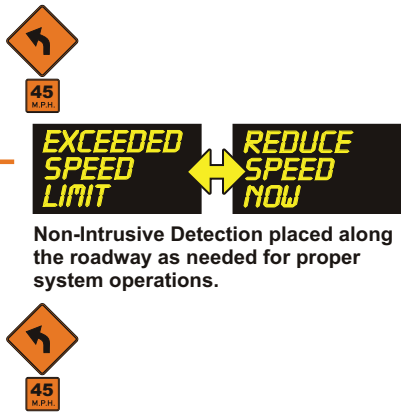

**NOTES**

- Advance warning signs and other standard temporary traffic control devices have not been shown on this figure. Refer to the MN MUTCD including the 2007 Field Manual or the TTC Layout Templates for typical layout examples.
- All IWZ Guide Signs and CMS should be reviewed by the Mn/DOT Office of Traffic, Safety, & Operations for design and message approval.
- Approved CMS messages should be listed in the Special Provisions, and approx CMS locations should shown on the TTC plans. All CMS displays should be blank when messages are not warranted.
- Refer to the Toolbox Definitions Section for graphic symbols and terms.



**WARRANTS**

- Workers will be located adjacent to the open traffic lane, or
- Hazardous roadway conditions require extra driving precautions.

**BENEFITS**

- The system should alert a driver of their current speed and what the advisory speed is posted for the situation.
- The system will alert drivers of their speed and provide sufficient time to slow before passing workers or entering a hazardous roadway condition.

**NOTE: The changes to this layout (in RED) are recommendations that are currently being studied for optimum sign usage and location. This preliminary layout should be followed until a final report made.**

Layouts are NOT drawn to scale.

The work crew (or poor road condition) should be visible to the driver from the point of viewing the Advisory Speed Plaque and DSD sign display. Preliminary studies show 500' is the optimum distance for speed reduction, therefore, it's advised to maintain that distance as much as practical. As workers move within the work zone, the DSD location should be re-positioned such that it remains within 500 feet (min) and 2500 feet (max) of the worker location. The distances may be adjusted following further studies of the DSD sign usage in work zones.

**MINIMUM SPECIFICATIONS on DSD SIGN EQUIPMENT:**

Display size of the DSD sign is dependent on the size of the speed plaque used.

Plaque size	DSD display MIN. character
18" X 18"	10"
24" X 24"	10"
30" X 30"	14" character
36" X 36"	14"

The static sign (YOUR SPEED) should be black letters on a **fluorescent orange** background when used with a work zone advisory speed plaque. The font should be a minimum of 4" high when used with a 10" display character, and 6" when used with a 14" or greater character display sign.

**OPERATIONAL GUIDELINES:**

The DSD sign should remain blank when no traffic is detected. When traffic speed is detected over the advisory speed plaque, the sign should blink at 50-60 cycles/minute. For speeds detected over a set max speed (generally 10 mph over the posted limit on low speed roadways and 20 mph over on high speed roadways) the display should go blank.

**NOTES**

- Advance warning signs and other standard temporary traffic control devices have not been shown on this figure. Refer to the Mn MUTCD including the 2007 Field Manual or the TTC Layout Templates for typical layout examples.
- All IWZ Guide Signs and CMS should be reviewed by the Mn/DOT Office of Traffic, Safety, & Operations for design and message approval.
- Approved CMS messages should be listed in the Special Provisions, and approx CMS locations should shown on the TTC plans. All CMS displays should be blank when messages are not warranted.
- Refer to the Toolbox Definitions Section for graphic symbols and terms.

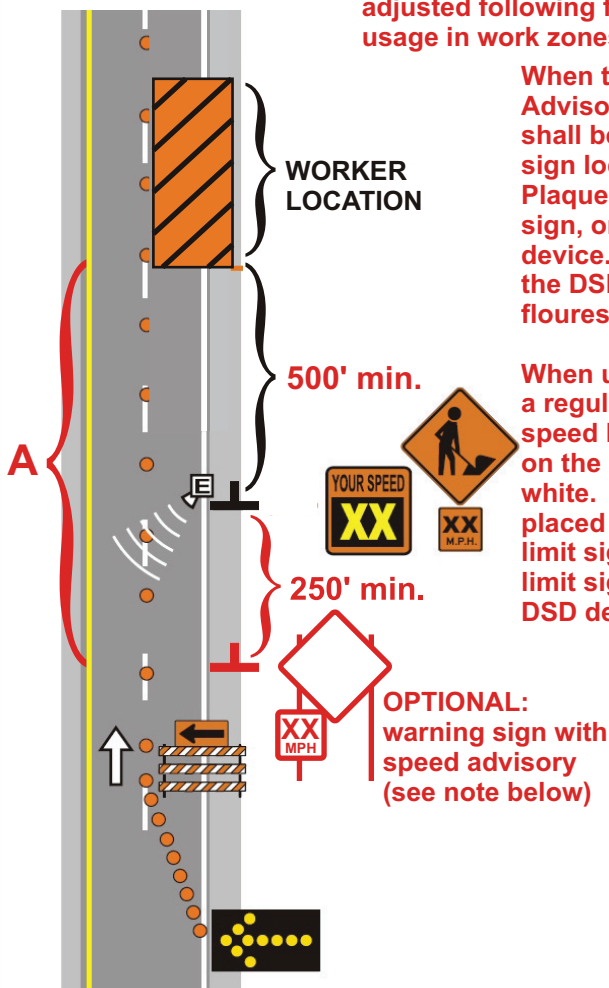

When the DSD sign is utilizing an Advisory Speed Limit, a warning sign shall be displayed adjacent to the DSD sign location. The Advisory Speed Plaque may be attached to the warning sign, or mounted on the DSD sign device. The "YOUR SPEED" sign on the DSD device shall be black on fluorescent orange.

When utilizing the DSD sign with either a regulatory speed limit or work zone speed limit, the "YOUR SPEED" sign on the DSD device shall be black on white. The DSD sign shall be either placed adjacent to the posted speed limit sign, or the appropriate speed limit sign shall be mounted to the DSD device.

OPTIONAL: warning sign with speed advisory (see note below)



When used, the optional advance warning sign with speed advisory should be placed a minimum distance 'A' ahead of the workers and a minimum 250 feet ahead of the DSD device location.

The distance 'A' is the Advance Warning Sign Spacing based upon the Posted Speed Limit and is found in the Field Manual (Part 6K of the MnMUTCD).



**VEHICLE RESPONSIVE**

**DYNAMIC SPEED DISPLAY**

Last Revision Date: **08/14/09**



**WARRANTS**

- Construction causes temporary minimal clearance (or less than minimum) for large vehicles using the roadway, or
- A minimal clearance condition exists within a work zone and construction vehicles must be warned of the condition.

**BENEFITS**

- The system should alert a driver that their vehicle is over-dimension and they are required to use an escape route.
- The system should alert drivers of their route mistake and provide sufficient time to conduct the escape maneuver.
- The second portion of the system warns a driver to stop if he failed to use the designated escape route.

Layouts are NOT drawn to scale.

**OPTIONS**

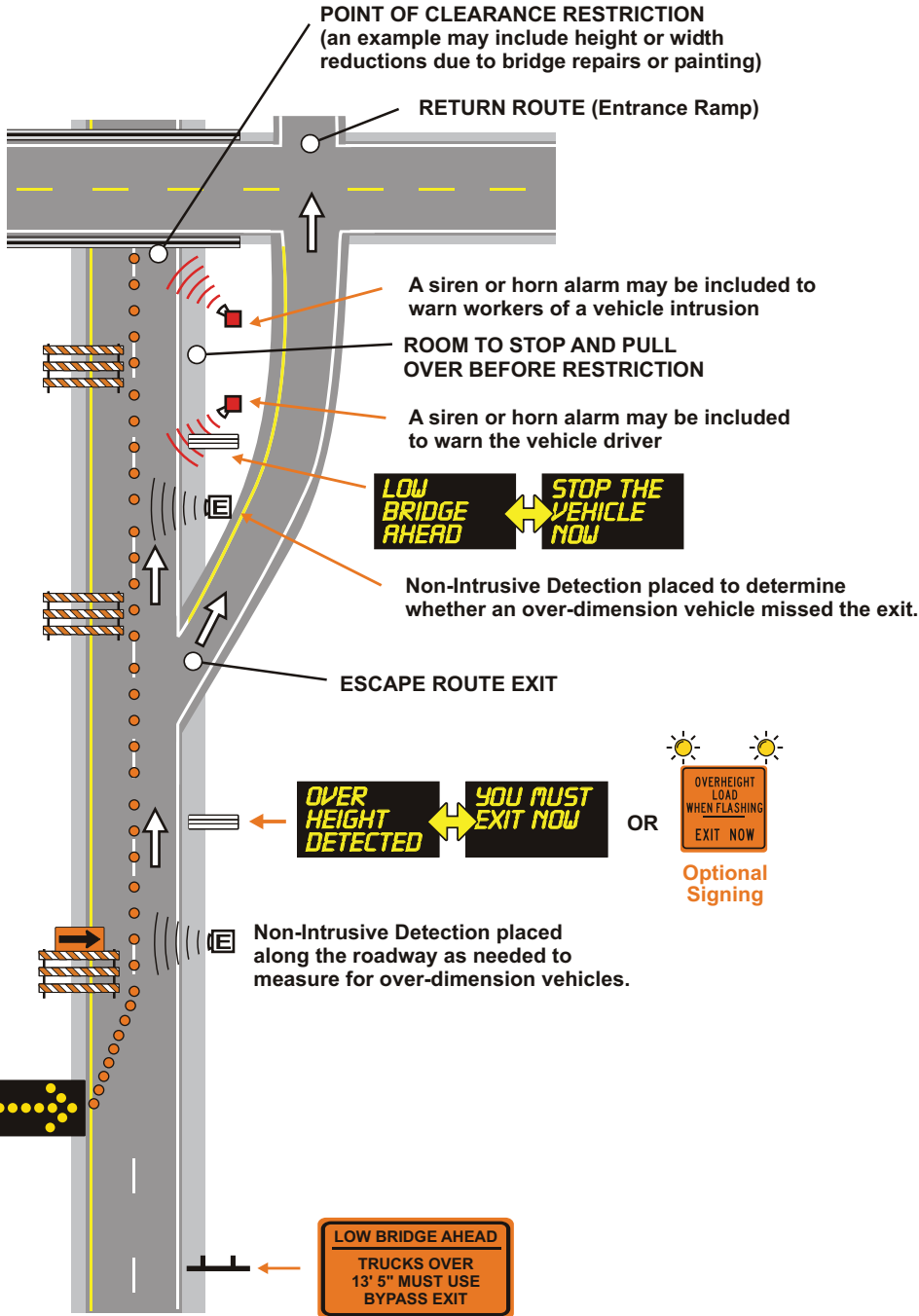

**NOTES**

- Advance warning signs and other standard temporary traffic control devices have not been shown on this figure. Refer to the MN MUTCD including the 2007 Field Manual or the TTC Layout Templates for typical layout examples.
- All IWZ Guide Signs and CMS should be reviewed by the Mn/DOT Office of Traffic, Safety, & Operations for design and message approval.
- Approved CMS messages should be listed in the Special Provisions, and approx CMS locations should shown on the TTC plans. All CMS displays should be blank when messages are not warranted.
- Refer to the Toolbox Definitions Section for graphic symbols and terms.



**VEHICLE RESPONSIVE**

**OVER DIMENSION WARNING**

Last Revision Date: 04-29-08

**WARRANTS**

**WORK SPACE INTRUSION:**

- Vehicles inadvertently fail to follow standard flagging operations.

**HAUL ROAD INTRUSION:**

- Vehicles inadvertently follow a truck off the roadway.
  - Reasons for following may vary:
    - High roadway volume causing tailgating
    - Truck exit is difficult to identify

**BENEFITS**

- The systems should alert a driver that they have inadvertently followed a construction truck into the construction zone or intruded into a work space.
- A work space intrusion system should alert a workers that a vehicle has intruded into the work zone.
- The systems should provide sufficient time for the driver to react appropriately, such as utilize an escape route back to the roadway traffic.

Layouts are NOT drawn to scale.

**OPTIONS**

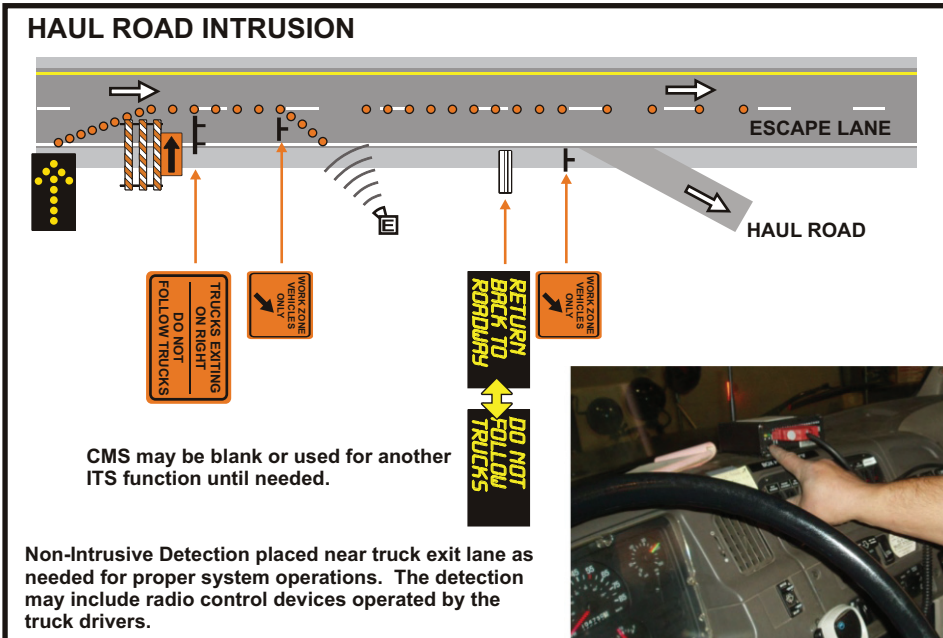
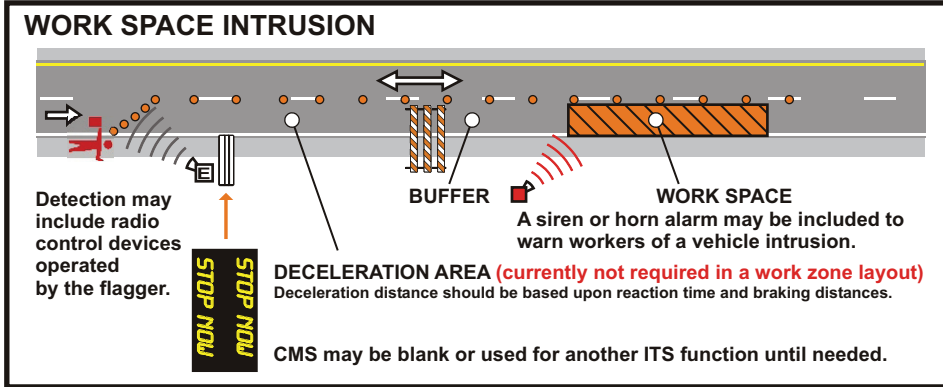

Display/alarms activated by truck driver

**NOTES**

- Advance warning signs and other standard temporary traffic control devices have not been shown on this figure. Refer to the MN MUTCD including the 2007 Field Manual or the TTC Layout Templates for typical layout examples.
- All IWZ Guide Signs and CMS should be reviewed by the Mn/DOT Office of Traffic, Safety, & Operations for design and message approval.
- Approved CMS messages should be listed in the Special Provisions, and approx CMS locations should shown on the TTC plans. All CMS displays should be blank when messages are not warranted.
- Refer to the Toolbox Definitions Section for graphic symbols and terms.

## WARRANTS

- The trucks must utilize the mainline roadway to accelerate.
- A truck merge lane can not be provided on the project.
- The haul road entrance is visibly obscured to drivers.
- The ADT on the roadway is above the level where truck drivers can easily find a gap in traffic and accelerate within the traffic lane without causing traffic to suddenly adjust speed or change lanes.

## BENEFITS

- The system should alert drivers of a slowly accelerating truck entering the faster moving traffic lane.
- The system should provide sufficient time for drivers to react appropriately, such as slowing down or changing lanes.
- 

Layouts are NOT drawn to scale.

## OPTIONS

- A variation of this system may be used to detect work vehicles in the vicinity which may create a traffic hazard. The example shown below warned the motorists when snow plows were clearing the roadway in a restricted section. The signs were activated by radio communications from the plow trucks.



## NOTES

- Advance warning signs and other standard temporary traffic control devices have not been shown on this figure. Refer to the MN MUTCD including the 2007 Field Manual or the TTC Layout Templates for typical layout examples.
- All IWZ Guide Signs and CMS should be reviewed by the Mn/DOT Office of Traffic, Safety, & Operations for design and message approval.
- Approved CMS messages should be listed in the Special Provisions, and approx CMS locations should shown on the TTC plans. All CMS displays should be blank when messages are not warranted.
- Refer to the Toolbox Definitions Section for graphic symbols and terms.

### Scenario A.

#### Dedicated Lane

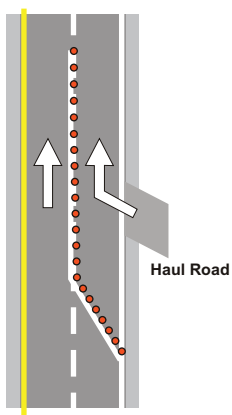

Typically, IWZ Systems are not needed for construction traffic is this scenario.

### Scenario B.

#### Acceleration Lane

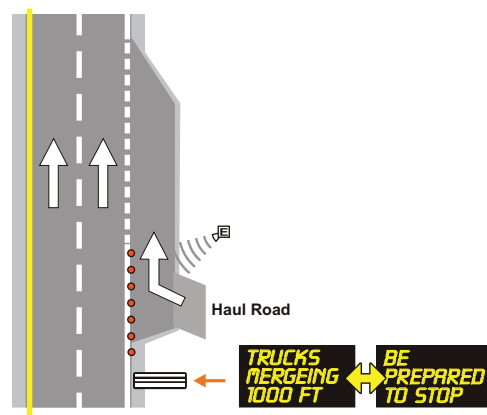

Although this scenario may operate efficiently without an IWZ system installed, higher traffic / truck volumes or a short acceleration lane would warrant the IWZ system.

### Scenario C. No Acceleration Lane

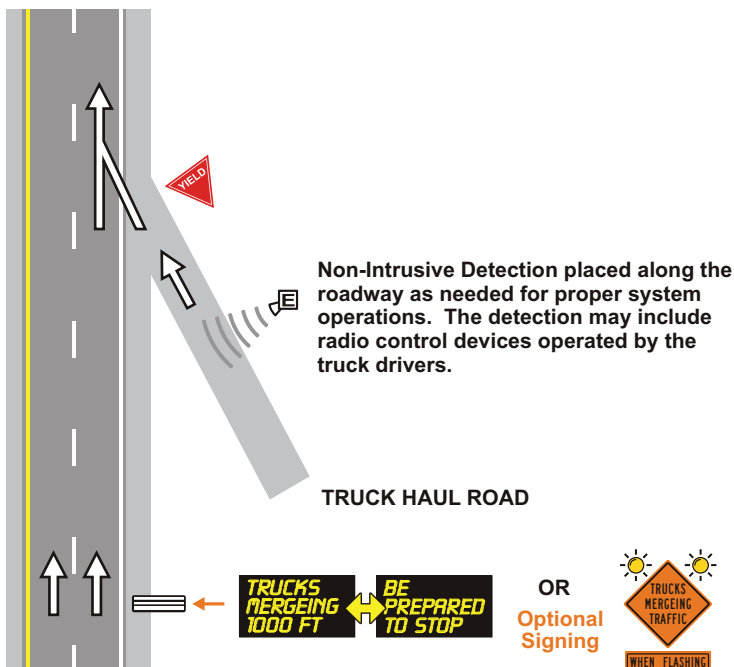

Non-Intrusive Detection placed along the roadway as needed for proper system operations. The detection may include radio control devices operated by the truck drivers.

TRUCK HAUL ROAD

OR  
Optional  
Signing



**WARRANTS**

- The ADT on the roadway is above the level where truck drivers can easily recognize a gap in traffic and safely cross without causing conflicts with traffic.
- 

**BENEFITS**

- The system should alert drivers of a slowly accelerating truck crossing the traffic lane.
- The system should provide drivers sufficient time to react appropriately, such as slowing down.
- 

Layouts are NOT drawn to scale.

**OPTIONS**

- When higher ADT conditions exist such that trucks are not able to find a gap in traffic, then additional traffic control systems, such as flaggers, stop signs or temporary signals, should be utilized to slow or stop traffic.
- The CMS may be replaced with an appropriate warning sign equipped with dynamically automated flashing lights as shown below and on scenario D.

**Scenario D.**

**Cross Single Lane**

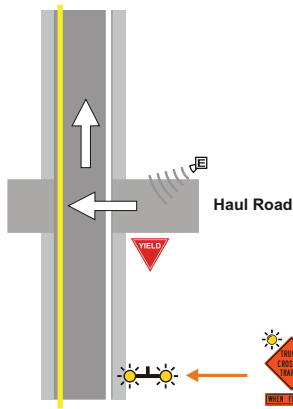

The crossing could be deployed with either the trucks yielding or the traffic yielding, depending upon the volume of each.

**Scenario E.**

**Cross Double Lane**

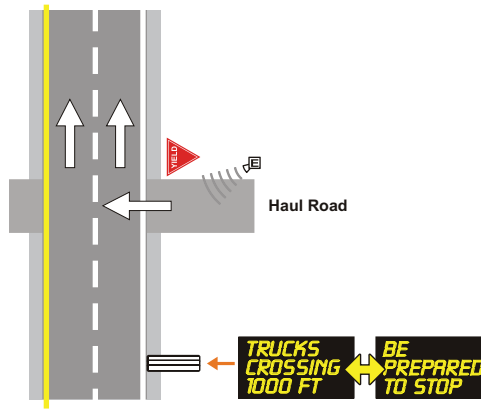

**Scenario F. Cross 2-Lane 2-Way**

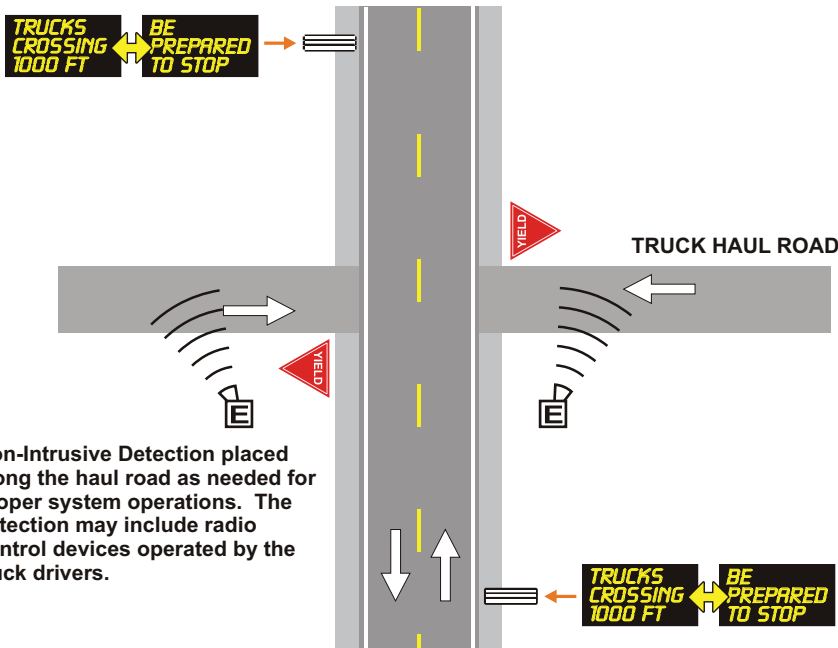

Non-Intrusive Detection placed along the haul road as needed for proper system operations. The detection may include radio control devices operated by the truck drivers.

**NOTES**

- Advance warning signs and other standard temporary traffic control devices have not been shown on this figure. Refer to the MN MUTCD including the 2007 Field Manual or the TTC Layout Templates for typical layout examples.
- All IWZ Guide Signs and CMS should be reviewed by the Mn/DOT Office of Traffic, Safety, & Operations for design and message approval.
- Approved CMS messages should be listed in the Special Provisions, and approx CMS locations should shown on the TTC plans. All CMS displays should be blank when messages are not warranted.
- Refer to the Toolbox Definitions Section for graphic symbols and terms.

**WARRANTS**

- The trucks must utilize the mainline roadway to de-accelerate, and
- The roadway volume is above the level where the traffic must suddenly adjust speed or change lanes.

**BENEFITS**

- The system should alert drivers of a decelerating truck exiting the faster moving traffic lane.
- The system should provide drivers sufficient time to react appropriately, such as slow down or change lanes if possible.

Layouts are NOT drawn to scale.

**OPTIONS**

**Scenario G.  
Dedicated Lane**

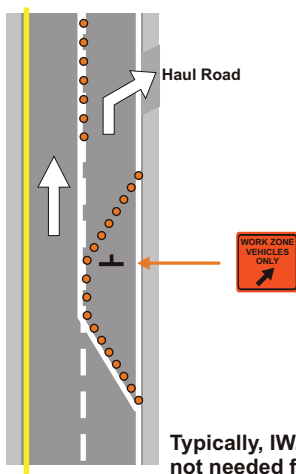

Typically, IWZ Systems are not needed for construction traffic is this scenario.

**Scenario H.  
De-acceleration Lane**

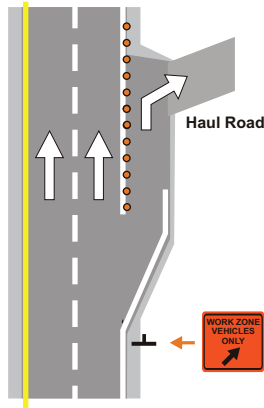

Typically, IWZ Systems are not needed for construction traffic is this scenario.

**Scenario I. No De-acceleration Lane**

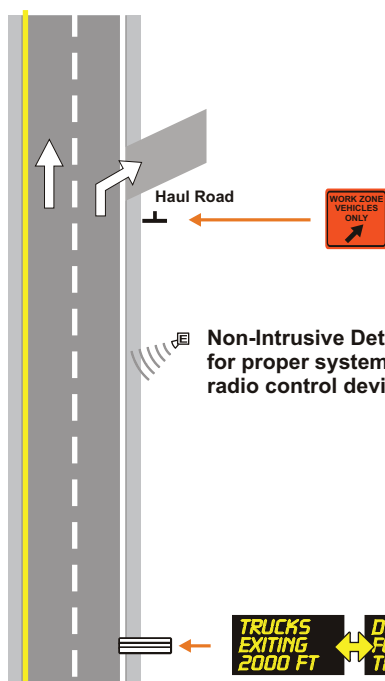

Non-Intrusive Detection placed along the roadway as needed for proper system operations. The detection may include radio control devices operated by the truck drivers.



**NOTES**

- Advance warning signs and other standard temporary traffic control devices have not been shown on this figure. Refer to the MN MUTCD including the 2007 Field Manual or the TTC Layout Templates for typical layout examples.
- All IWZ Guide Signs and CMS should be reviewed by the Mn/DOT Office of Traffic, Safety, & Operations for design and message approval.
- Approved CMS messages should be listed in the Special Provisions, and approx CMS locations should shown on the TTC plans. All CMS displays should be blank when messages are not warranted.
- Refer to the Toolbox Definitions Section for graphic symbols and terms.



**VEHICLE  
RESPONSIVE**

**TRUCKS EXITING TRAFFIC WARNING**

Last Revision Date: 04-29-08

**WARRANTS**

- The system should be considered for deployment as part of a project’s temporary traffic control plan when a temporary situation may cause a hazardous driving condition such as:
  - Flash flooding
  - Visibility (fog, smoke)
  - Slippery or rough conditions
  - Hazards on roadway (falling rock, debris)

**BENEFITS**

- The system should alert traffic of a hazardous condition on the roadway ahead and advise traffic of an appropriate action for the situation which may range from stopping, slowing, or diverting traffic.
- The system should notify construction staff of the situation such that corrective actions may begin.

Layouts are NOT drawn to scale.

**OPTIONS**

**Example: Area prone to Flash Flooding due to poor roadway drainage during a construction stage.**

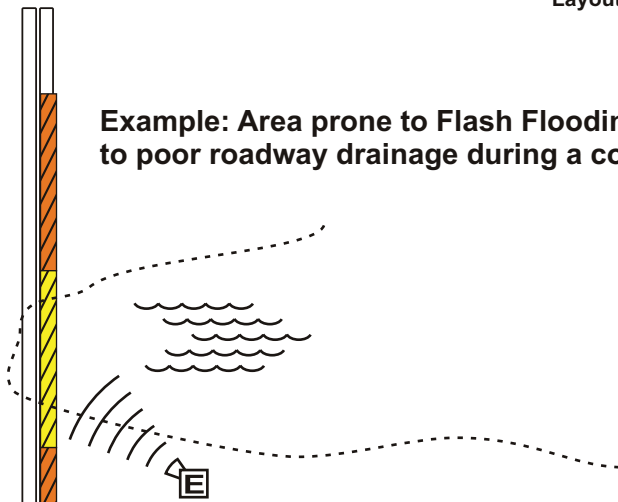

**Non-Intrusive Detection spaced along the route as needed for proper system operations**



**NOTES**

- Advance warning signs and other standard temporary traffic control devices have not been shown on this figure. Refer to the MN MUTCD including the 2007 Field Manual or the TTC Layout Templates for typical layout examples.
- All IWZ Guide Signs and CMS should be reviewed by the Mn/DOT Office of Traffic, Safety, & Operations for design and message approval.
- Approved CMS messages should be listed in the Special Provisions, and approx CMS locations should shown on the TTC plans. All CMS displays should be blank when messages are not warranted.
- Refer to the Toolbox Definitions Section for graphic symbols and terms.



**WARRANTS**

- Refer to the "Guideline for Establishing Work Zone Speed Limits" for the procedure to change speed limits.
- 

**BENEFITS**

- The traffic control supervisor will be able to change the work zone speed limit easily without manually covering signs.
- 
- 

Layouts are NOT drawn to scale.

**OPTIONS**

- The CMS characters may be replaced with static regulatory speed limits printed with the appropriate speed values. The traffic control supervisor would be responsible to exchange the signs to enable the work zone speed limit to be enforceable and must return the normal posted speed limit following the approved time period. There are variations of covering the existing signs as approved alternatives to removing the signs.

**OPERATIONAL NOTES:**

- The static speed limit signs are equipped with 2 CMS characters that can be changed from a remote location by the traffic control supervisor for the project.
- The original posted speed limit signs shall be removed or covered while the device is activated.
- The posted speed limit value is changed to an approved enforceable 'Work Zone Speed Limit' during the designated time periods specified in the TTC plans or special provisions for the project. After the specified time period, the value of the sign is changed back to the normal posted speed for the roadway.

For example, the time period may be based upon the presence of workers, or high volume of construction traffic.

- The traffic control supervisor shall drive through the work zone after the CMS display change to verify the correct value is displayed.



**NOTES**

- Advance warning signs and other standard temporary traffic control devices have not been shown on this figure. Refer to the MN MUTCD including the 2007 Field Manual or the TTC Layout Templates for typical layout examples.
- All IWZ Guide Signs and CMS should be reviewed by the Mn/DOT Office of Traffic, Safety, & Operations for design and message approval.
- Approved CMS messages should be listed in the Special Provisions, and approx CMS locations should shown on the TTC plans. All CMS displays should be blank when messages are not warranted.
- Refer to the Toolbox Definitions Section for graphic symbols and terms.

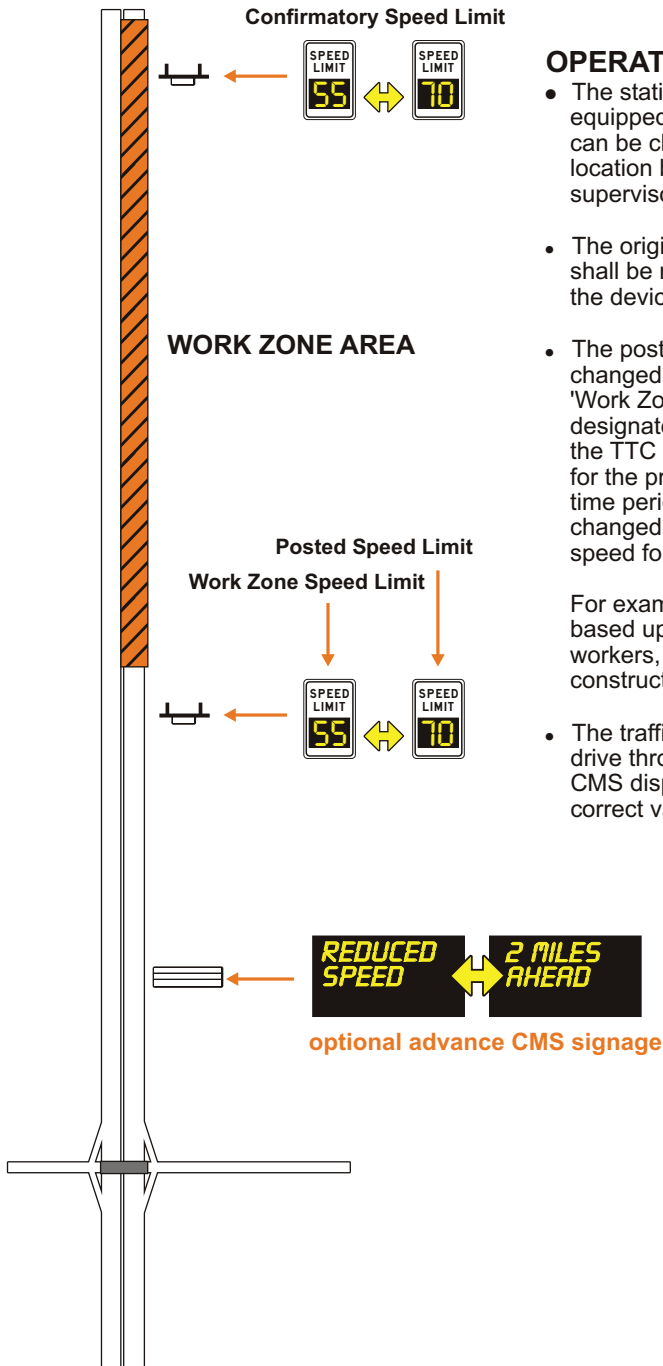



**WARRANTS**

- 

**BENEFITS**

- 

# SHEET UNDER DEVELOPMENT

Layouts are NOT drawn to scale.

**OPTIONS**

**Various real-time informational methods may be deployed as required for the intended audience including:**

- Real-time Highway Advisory Radio may broadcast real-time:
  - travel times on various routes between landmarks,
  - project staging information such as pending traffic changes,
  - alternate route information with congestion information, and/or
  - alternate route information with incident information.
- 511mn.org should be updated continually to have real-time travel information through the work zone. This information is available to the motorist via cell phone (and internet).
- Real-time information available online for the project's work zone and vicinity which could include information on current incidents, congestion, traffic control changes, travel delays/times or other traffic data that may be requested.
- Email notices with the current information could be generated based upon parameters pre-selected by subscribers, such as per-determined time-of-day, major incidents, major congestion, etc.



**NOTES**

- Advance warning signs and other standard temporary traffic control devices have not been shown on this figure. Refer to the MN MUTCD including the 2007 Field Manual or the TTC Layout Templates for typical layout examples.
- All IWZ Guide Signs and CMS should be reviewed by the Mn/DOT Office of Traffic, Safety, & Operations for design and message approval.
- Approved CMS messages should be listed in the Special Provisions, and approx CMS locations should shown on the TTC plans. All CMS displays should be blank when messages are not warranted.
- Refer to the Toolbox Definitions Section for graphic symbols and terms.

Use this Decision Tree to Identify Potential ITS/IWZ Scoping Needs - January 31, 2018 Version 1

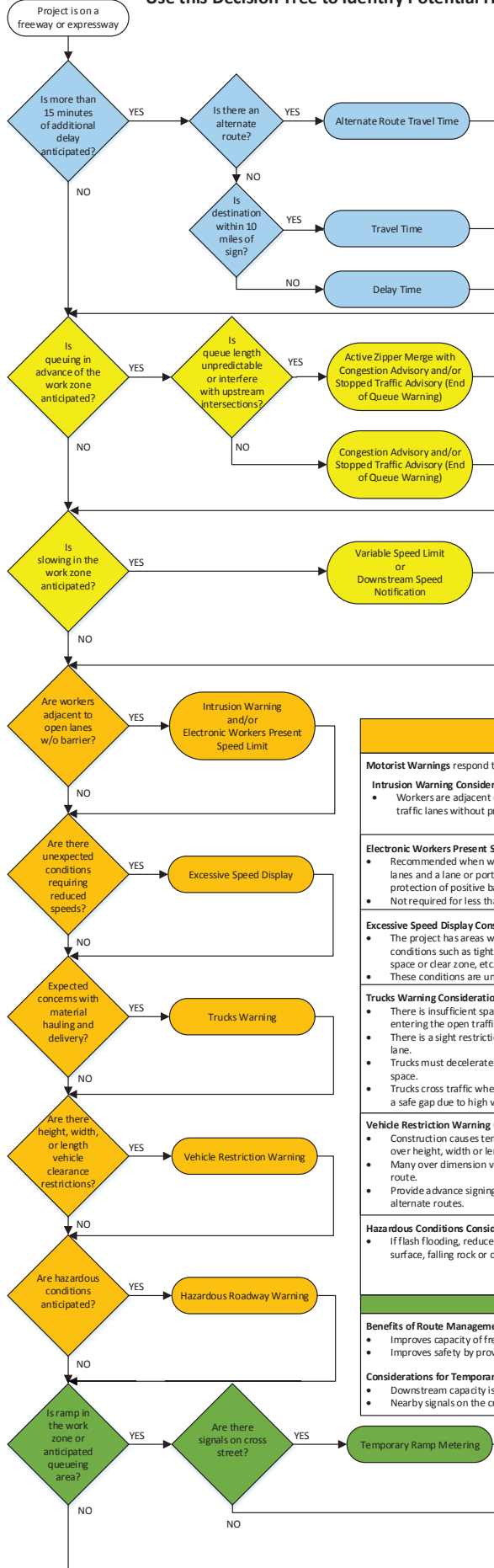

Mobility and Traveler Information	
<p><b>Considerations for Alternate Route Travel Times:</b></p> <ul style="list-style-type: none"> <li>Alternate route travel times are calculated and displayed for selected alternate route(s) and the main route through the work zone to provide options to drivers.</li> <li>Travel times on the main route and alternate route(s) vary independently, i.e. one route changes while the other does not.</li> <li>Care should be taken to determine proximity to other projects when selecting alternative routes to display travel times.</li> </ul> <p><b>Considerations to Ensure Times Displayed are Accurate:</b></p> <ul style="list-style-type: none"> <li>Maximum detector spacing is 1/2 mile.</li> <li>Travel Time is used when the time display is within 10 miles of the destination shown on the sign.</li> <li>Delay Time is used when the time display is more than 10 miles from the destination shown on the sign.</li> </ul>	<p><b>Benefits of Mobility and Traveler Information:</b></p> <ul style="list-style-type: none"> <li>Allows drivers to decide whether to change routes.</li> <li>Provides opportunities to notify others of estimated arrival times.</li> <li>Provides sufficient information to calm tempers.</li> </ul> <p><b>Options for Travel Time and Delay Time Information Displays:</b></p> <ul style="list-style-type: none"> <li>Dynamic Message Sign (DMS), both portable or permanent.</li> <li>Static Guide Sign with DMS characters to display time.</li> </ul>
Motorist Advisory	
<p><b>Considerations for Motorist Advisory Systems:</b></p> <ul style="list-style-type: none"> <li>Queue lengths are anticipated to be unpredictable because they vary greatly daily and/or hourly.</li> <li>The end of queue encroaches upstream beyond drivers' expectations or are obscured by roadway geometry.</li> <li>Queues are expected to encroach on upstream intersections or interchanges.</li> </ul> <p><b>Active Zipper Merge:</b></p> <ul style="list-style-type: none"> <li>Typically includes a Congestion Advisory and/or Stopped Traffic Advisory.</li> <li>Reduces queue lengths by 40%.</li> <li>Harmonizes speeds between lanes approaching the lane closure.</li> <li>Increases capacity through the work zone.</li> <li>Reduces driver frustration and decreases aggressive driving behavior.</li> </ul> <p><b>Congestion Advisory:</b></p> <ul style="list-style-type: none"> <li>Is used when the congested traffic message can be far enough away that motorists can select alternate routes.</li> <li>Is typically combined with a Stopped Traffic Advisory (End of Queue Warning Systems) as motorists approach the work zone.</li> </ul> <p><b>Stopped Traffic Advisory (End-of-Queue Warning):</b></p> <ul style="list-style-type: none"> <li>Is used to warn drivers of slow or stopped traffic ahead and that prompt action is required.</li> </ul> <p><b>Variable Speed Limit:</b></p> <ul style="list-style-type: none"> <li>Authorized speed limit for driver safety, to navigate the work zone.</li> </ul> <p><b>Downstream Speed Notification:</b></p> <ul style="list-style-type: none"> <li>Gives drivers an appropriate speed to travel through the work zone with minimal braking by providing notification 1/2 mile ahead of slower moving traffic.</li> <li>Smooths the transition between faster and slower moving traffic.</li> <li>Increases capacity through the work zone.</li> </ul>	<p><b>Benefits of Motorist Advisory:</b></p> <ul style="list-style-type: none"> <li>Alert drivers they are approaching slow or stopped traffic.</li> <li>Reduce frequency and severity of rear-end crashes.</li> <li>May reduce demand by diverting traffic.</li> </ul>
Motorist Warning	
<p><b>Motorist Warnings</b> respond to individual conditions, i.e. vehicle speed, dimension, weather, etc. that require drivers to take immediate action.</p> <p><b>Intrusion Warning Considerations:</b></p> <ul style="list-style-type: none"> <li>Workers are adjacent (i.e. within 12 feet) to open high-speed traffic lanes without protection of positive barrier.</li> </ul> <p><b>Intrusion Warning Benefits:</b></p> <ul style="list-style-type: none"> <li>Alerts drivers and workers that a vehicle is entering the work space giving enough time for workers and drivers to take evasive action to avoid a crash or reduce severity.</li> </ul> <p><b>Electronic Workers Present Speed Limit Considerations:</b></p> <ul style="list-style-type: none"> <li>Recommended when workers are directly adjacent to travel lanes and a lane or portion thereof is closed to traffic without protection of positive barrier.</li> <li>Not required for less than 24 hours.</li> </ul> <p><b>Electronic Workers Present Speed Limit Benefits:</b></p> <ul style="list-style-type: none"> <li>Regulatory speed limits to improve worker safety, intended that the speed limit reduces speed such that the majority of hazards can be safely negotiated.</li> </ul> <p><b>Excessive Speed Display Considerations:</b></p> <ul style="list-style-type: none"> <li>The project has areas where reduced speed is indicated for conditions such as tight curves, rough surfaces, reduced buffer space or clear zone, etc.</li> <li>These conditions are unexpected by the driver.</li> </ul> <p><b>Excessive Speed Display Benefits:</b></p> <ul style="list-style-type: none"> <li>Warns driver to reduce speed to safely travel through the work zone.</li> </ul> <p style="text-align: center;"><b>This is not a work zone speed limit.</b></p> <p><b>Trucks Warning Considerations:</b></p> <ul style="list-style-type: none"> <li>There is insufficient space for a truck acceleration lane prior to entering the open traffic lane.</li> <li>There is a sight restriction where trucks must enter the open traffic lane.</li> <li>Trucks must decelerate in the open lane before entering the work space.</li> <li>Trucks cross traffic where it is difficult for truck drivers to recognize a safe gap due to high vehicle volumes or sight restrictions.</li> </ul> <p><b>Truck Warning Benefits:</b></p> <ul style="list-style-type: none"> <li>Drivers are able to adjust speed and lane position to facilitate safe operation of construction vehicles.</li> <li>Drivers are less likely to follow vehicles into the work zone.</li> <li>Drivers are aware of the presence of slow moving construction vehicles.</li> </ul> <p><b>Vehicle Restriction Warning Considerations:</b></p> <ul style="list-style-type: none"> <li>Construction causes temporary reduction in vehicle clearance for over height, width or length vehicles.</li> <li>Many over dimension vehicles are anticipated to be using the route.</li> <li>Provide advance signing prior to major junctions that could serve as alternate routes.</li> </ul> <p><b>Vehicle Restriction Warning Benefits:</b></p> <ul style="list-style-type: none"> <li>Alerts drivers of over dimension vehicles to stop and seek alternate routes.</li> <li>Warns workers that an over dimension vehicle is approaching.</li> </ul> <p><b>Hazardous Conditions Considerations:</b></p> <ul style="list-style-type: none"> <li>If flash flooding, reduced visibility (fog, smoke), slippery or rough surface, falling rock or debris, etc. are anticipated.</li> </ul> <p><b>Hazardous Conditions Benefits:</b></p> <ul style="list-style-type: none"> <li>Drivers are alerted to condition and can take corrective action.</li> <li>Project personnel can be immediately alerted to the condition so they may take correction action.</li> </ul>	
Route Management Systems	
<p><b>Benefits of Route Management Systems:</b></p> <ul style="list-style-type: none"> <li>Improves capacity of freeway by reducing turbulence and shockwaves caused by entering traffic.</li> <li>Improves safety by providing uniform traffic speeds.</li> </ul> <p><b>Considerations for Temporary Ramp Metering:</b></p> <ul style="list-style-type: none"> <li>Downstream capacity is exceeded reducing the maximum volume on the freeway.</li> <li>Nearby signals on the cross street or ramp terminals create platoons of vehicles entering the freeway creating turbulence and shock waves.</li> </ul>	

# Cost Estimates for ITS/IWZ Scoping

June 6, 2018

Version 2

## ASSUMPTIONS AND BASIS FOR COST ESTIMATES FOR ITS/IWZ SCOPING

- These ITS/IWZ cost estimates are based on current MnDOT rental prices.
- All assumptions included below should be used while developing estimates for planning purposes.

### High Level Cost Estimate for Mobility and Traveler Information Systems

High level cost estimates may be used if the duration of the ITS/IWZ need is unknown.

\$140,000 for a system with NO alternate route      \$280,000 for a system with one alternate route

A more accurate estimate can be made if the project duration and the availability of an alternate route are known.

### Detailed Estimate for Mobility and Traveler Information Systems

Assumptions for these system estimates:

- Project and alternate routes are 10 miles long.
- Detectors are placed every ½ mile.
- Travel/delay time will be provided for both directions in the work zone.
- One PCMS is used for each direction.
- Additional mile cost is for one direction only.

System Control and Management	Contractor Provided*		
	1 week	4 weeks	6 months
Duration			
Travel/Delay Time (NO alternate route)	\$16,000	\$35,000	\$145,000
Travel/Delay Time (one alternate route)	\$31,000	\$70,000	\$290,000
Cost per additional mile per direction	\$1,300	\$ 3,500	\$13,000

\*Contact the RTMC Freeway Operations Engineer @ (651)234-7022 to determine feasibility of using the RTMC and IRIS for ITS/IWZ system.

### High Level Cost Estimate for Motorist Advisory Systems

High level cost estimates may be used if the duration and number of directions for the ITS/IWZ need is unknown.

\$75,000 for each system

Each of the suggested motorist advisory systems have similar costs:

- Active Zipper Merge
- Congestion Advisory
- Stopped Traffic Advisory (End of Queue Warning)
- Variable Speed Limit or Downstream Speed Notification

A more accurate estimate can be made if the number of directions and duration of the deployment are known.

### Detailed Estimate for Motorist Advisory Systems (cost per system)

Assumptions for these systems:

- Anticipated queue is three (3) miles.
- Detectors are placed every ½ mile.
- PCMS are placed every 2 miles (mile 1 and 3 in advance of lane closure taper).
- Additional mile cost is for one direction only.

System Control and Management	Contractor Provided*		
	1 week	4 weeks	6 months
Duration			
One Direction	\$7,000	\$13,000	\$58,000
Two Directions	\$13,000	\$25,000	\$115,000
Cost for each mile of additional queue length	\$1,700	\$4,200	\$15,000

\*Contact the RTMC Freeway Operations Engineer @ (651)234-7022 to determine feasibility of using the RTMC and IRIS for ITS/IWZ system.

### High Level Cost Estimate for Motorist Warning Systems

High level cost estimates may be used if the duration for the ITS/IWZ need is unknown.

\$13,000 for each system

Each of the suggested motorist warning systems have similar costs:

- Excessive Speed Display
- Trucks Warning
- Vehicle Restriction Warning
- Hazardous Roadway Warning

Note:

MnDOT is currently evaluating various systems and has not selected a final technology or design for Intrusion Warning and Electronic Workers Present Speed Limit systems.

A more accurate estimate can be reached if the duration of the ITS/IWZ need is known.

### Detailed Estimate for Motorist Warning Systems (cost per system per site)

Assumptions for these systems:

- There is a single system at a single site within the project.
- RTMC and IRIS cannot be used for control, therefore all control and system management is Contractor provided.

Duration	1 week	4 weeks	6 months
Single Site – Excessive Speed Display	\$1,000	\$2,200	\$6,000
Single Site – All Others	\$2,000	\$3,500	\$13,000

### Route Management Systems

All Route Management Systems are controlled by the RTMC and IRIS\*.

\*Contact the RTMC Freeway Operations Engineer @ (651)234-7022 to determine feasibility and cost for these systems.

**Texas Department of Transportation**

Smart Work Zone Guidelines: Design Guidelines for Deployment of Work Zone Intelligent Transportation Systems (ITS) – October 2018

<http://ftp.dot.state.tx.us/pub/txdot-info/trf/smart-work-zone-guidelines.pdf>

Go/No Go Decision Tool for SWZ Systems

<https://m.txdot.gov/inside-txdot/division/traffic/smart-work-zones.html>

# Smart Work Zone Guidelines

Design Guidelines for  
Deployment of Work Zone  
Intelligent Transportation  
Systems (ITS)

October 2018



THIS PAGE HAS INTENTIONALLY BEEN LEFT BLANK

# Smart Work Zone Guidelines

## Executive Summary

Intelligent Transportation Systems (ITS) can be utilized in highway work zones to help improve public safety and mobility. The resulting systems are commonly referred to as “Smart Work Zones” (SWZ) because they leverage the information derived from the ITS equipment to improve operations within and around the work zones.

Texas Department of Transportation’s (TxDOT) use of ITS in work zones is intended to improve safety for motorists as well as the work zone personnel. Other benefits include reducing traffic delay through work zones, providing effective construction-related information to the public, and providing performance metrics for future work zone design improvements.

This document presents the basic guidelines for the consistent and uniform application of SWZs in the State of Texas. It is not intended to supersede the requirements TxDOT and Federal Highway Administration (FHWA) already have in place for designing work zones such as the Texas Manual on Uniform Control Devices (TMUTCD), TxDOT standards, and any other recognized practices commonly used for road and bridge design projects.



# Contents

- 1. Introduction..... 9**
  - 1.1 Introduction to Smart Work Zones .....9
  - 1.2 Purpose of this Report.....9
  - 1.3 Smart Work Zones Regulation and Guidance..... 10
  - 1.4 Smart Work Zones: Principles and Applications.....11
- 2. TxDOT Smart Work Zone Systems.....16**
  - 2.1 Temporary Queue Detection System ..... 18
  - 2.2 Temporary Speed Monitoring System .....20
  - 2.3 Temporary Construction Equipment Alert System.....22
  - 2.4 Temporary Travel Time System ..... 24
  - 2.5 Temporary Incident Detection and Surveillance System .....26
  - 2.6 Temporary Over-Height Vehicle Warning System.....28
- 3. Selection Procedure for Smart Work Zones .....31**
  - 3.1 Identification of Work Zone Data Needs .....31
  - 3.2 Selection Process & Criteria.....33
- 4. Smart Work Zone Design .....37**
  - 4.1 Temporary Queue Detection System .....38
  - 4.2 Temporary Speed Monitoring System .....40
  - 4.3 Temporary Construction Equipment Alert System.....42
  - 4.4 Temporary Travel Time System .....43
  - 4.5 Temporary Incident Detection and Surveillance System .....44
  - 4.6 Temporary Over-Height Vehicle Warning System.....45
  - 4.8 Typical costs.....46
- 5. Smart Work Zone Deployment.....49**
  - 5.1 Operation and Maintenance .....49
  - 5.2 SWZ Data .....49
  - 5.3 Evaluation .....49
  - 5.4 Decommission/Removal .....49

**References..... 51**

**Appendices ..... 52**

    Appendix A. SWZ System Go/No-Go Decision Tool ..... 53

    Appendix B. Maximum Queue Length Estimator ..... 60

    Appendix C. SWZ System Cost Examples ..... 61

## List of Figures

Figure 1: System Engineering 'V' Diagram .....13

Figure 2: Timelines showing TxDOT Construction Process and Smart Work Zone Life Cycle ..... 14

Figure 3: Temporary Queue Detection System.....19

Figure 4: Temporary Speed Monitoring System ..... 21

Figure 5: Temporary Construction Equipment Alert System ..... 23

Figure 6: Temporary Travel Time System ..... 25

Figure 7: Temporary Incident Detection and Surveillance System ..... 27

Figure 8: Temporary Over-Height Vehicle Warning System ..... 29

## List of Tables

Table 1: Smart Work Zone Systems .....	17
Table 2: Typical messages to be displayed on PCMS .....	18
Table 3: Selection Process and Criteria.....	34
Table 4: Temporary Queue Detection System Performance Measures .....	39
Table 5: Temporary Speed Monitoring System Performance Measures.....	41
Table 6: Temporary Construction Equipment System Performance Measures.....	42
Table 7: Temporary Travel Time System Performance Measures.....	43
Table 8: Temporary Incident Detection and Surveillance System Performance Measures .....	44
Table 9: Temporary Over-Height Vehicle Warning System Performance Measures.....	45

THIS PAGE HAS INTENTIONALLY BEEN LEFT BLANK

---

# 1. Introduction

---

## 1.1 Introduction to Smart Work Zones

This guide provides an introduction to six Smart Work Zone (SWZ) systems that have been identified by TxDOT for use in work zones. It includes System Selection Decision Tools, which use project specific criteria for Go/No-Go decisions for each of these systems and Function Selection Decision Tools to meet specific project needs. These tools are intended to streamline the design process and produce a uniform SWZ delivery across the State.

**The six SWZ systems include the following:**

**Temporary Queue Detection:** To address the safety issue of slowed or stopped traffic on the approaches of work zones.

**Temporary Speed Monitoring:** To improve speed zone compliance and encourage more uniform speeds.

**Temporary Construction Equipment Alerts:** To inform motorists when material handling vehicles enter the traffic stream.

**Temporary Travel Time Display:** To help approaching motorists make informed decisions about route choices.

**Temporary Incident Detection and Surveillance:** To provide situational awareness and faster responses to incidents.

**Temporary Over-Height Vehicle Warning:** To provide advance warning alerts for projects with low structures.

This guide explains the rationale for how to use SWZ system selection criteria, and describes how the SWZ design process parallels the road/bridge project design. It also clarifies how Systems Engineering fits into the SWZ process, and details the effective use of performance metrics.

## 1.2 Purpose of this Report

This technical report presents TxDOT's recommendations for the basic guidelines for incorporating Intelligent Transportation Systems (ITS) into the TCP for roadway construction projects. These guidelines are intended to clarify what ITS Systems are appropriate for "Smart Work Zones" on TxDOT projects, provide general design and deployment guidance for these systems, and support state-wide work zone ITS standards and specifications.

This report complements existing design practices for work zones, and is not intended to supersede or replace existing standards, Texas MUTCD requirements or other common design practices being used to develop plans and specifications for road or bridge projects in Texas. This is particularly important because the Highway and Bridge Engineers responsible for construction work zones are often unfamiliar with ITS Technologies. These guidelines provide user friendly design tools that help engineers choose and produce consistent and appropriate systems.

## 1.3 Smart Work Zones Regulation and Guidance

The following excerpt from the February 2016 version of the Massachusetts Department of Transportation's Smart Work Zone Standard Operating Procedures describes the FHWA basis for regulation and guidance of Smart Work Zones.

---

### Federal Highway Administration (FHWA)

---

In September 2004, FHWA updated the Work Zone Safety and Mobility Rule 23 CFR 630 Subpart J. The Rule applies to all state and local governments that receive Federal-Aid highway funding for road and bridge construction projects. The rule outlined clear and definitive provisions and compliance dates for State and local transportation agencies that using Federal-Aid as follows:

- Define a clear and comprehensive process for evaluating and mitigating the impacts of construction work zones.
- Provide safe work zones for all workers and road users while also providing for the highest level of mobility.
- Define the evaluation techniques to be used during the planning, design, and construction phases of a project.

In 2007, FHWA issued the Work Zone Operations Best Practices Guidebook to provide a compilation of successful work zone operations practices used and recommended by several states and localities for other agencies to determine which of these practices are best suited for their particular situations. Some of those practices deal with the utilization of ITS systems to automatically collect and analyze data, and provide real-time information to motorists and to the construction team.

In addition to the aforementioned publications, FHWA has made available a number of resources developed by the academia, and local and state agencies for implementing various types of ITS in work zones. Such resources can be accessed through FHWA's Work Zone Mobility and Safety Program website<sup>1</sup>. The practices described in the guidebook and the website are intended as a descriptive, not prescriptive, depiction of the subject.

---

<sup>1</sup> <http://www.ops.fhwa.dot.gov/wz/its/indeg.htm>.

## Texas Department of Transportation

### Vision and Mission

**Vision: 'A forward-thinking leader delivering mobility, enabling economic opportunity, and enhancing quality of life for all Texans.'**

**Mission: 'Through collaboration and leadership, we deliver a safe, reliable, and integrated transportation system that enables the movement of people and goods.'**

TxDOT has identified Smart Work Zones as a priority in their response to the FHWA Work Zone Safety and Mobility Guidelines.



## 1.4 Smart Work Zones: Principles and Applications

### Definition

The term “Smart Work Zone” is synonymous with the term “Work Zone ITS”. Both refer to the deployment of ITS technologies and strategies to enhance mobility and safety in and around work zones. They are usually deployed on a temporary basis until the interruptions from roadway construction are over.

These technologies typically produce data and/or images that are processed to become actionable information. In some cases the technology is designed to process the data instantly and then take immediate action without human intervention (e.g. End of Queue detection triggering an upstream Portable Changeable Message Sign to alert approaching motorists). In other cases the data is used by traffic operation dispatchers or others to achieve situational awareness. Once alerted to unfavorable conditions, they quickly follow, or verify pre-planned protocols to respond to these incidents. In both cases, the data can be recorded for use in reports for administrators in decision making. Performance metrics guide decisions that influence the refinement of operational practices for current and future work zones.

### Rationale

The intent is to leverage the benefits of Smart Work Zones (SWZs) to improve traffic safety and efficiency ahead of and through highway construction areas. As a strategy to improve safety in our work zones has increased along with the substantial projects programmed by TxDOT in the future, the demand for Smart Work Zones in Texas is imminent. This includes strategies for optimizing the use of these technologies and prioritizing selections to fit into a fiscally constrained program for Traffic Maintenance and Operations. Because SWZs typically involve the production and use of information, feedback from these systems in the form of performance metrics can be used to guide these choices and refine strategies to achieve the goal of improving efficiency and reducing the crash rate in highway construction work zones.

A recent study by Texas Southern University (FHWA/TX-17/0-6915-1) was conducted in cooperation with TxDOT and FHWA to Identify Project Criteria for ITS Deployment in work zones. The conclusions and recommendations of that study closely parallel the strategies recommended in these guidelines.

## Systems Engineering for Smart Work Zones

FHWA places an emphasis on using the Systems Engineering process to develop any new ITS solutions. This is typically summarized in a “V” diagram as shown in Figure 1.

Some early applications of SWZs around the country failed to deliver benefits due to poor planning, confusing requirements and a lack of integration. Many of these issues are due to the fact that the SWZ design is introduced into the road design process too late, sometimes even after letting. A Systems Engineering process can address these issues. (More information on the Systems Engineering Process can be found at: [https://ops.fhwa.dot.gov/int\\_its\\_deployment/sys\\_eng.htm](https://ops.fhwa.dot.gov/int_its_deployment/sys_eng.htm) )

It takes considerable effort to produce an effective Smart Work Zone that integrates properly with the various phases of large road construction projects. This is aggravated by the fact that much of the ITS device placement cannot begin until the changing traffic patterns in the construction project have been identified.

This “V” diagram shows the sequence of Systems Engineering steps that can be used to ensure a final product closely resembles its initial vision. Although Systems Engineering was originally developed by the National Aeronautics and Space Administration (NASA) to effectively manage very large complex projects that typically produce brand new technology solutions, an abbreviated version of this process can be useful for developing SWZs as explain below.

Most of the ITS devices used in SWZs have already been vetted through product acceptance testing and field experience. Therefore, some of the elements on the declining left branch of the “V” Diagram have already been “pre-engineered” into what we are calling “Systems” which, as mentioned earlier, are assembled devices configured to accomplish objectives. Depending on the project’s level of complexity, the left, declining branch of the “V” diagram can be abbreviated to diminish the need for a full Concept of Operations (ConOps) and a High Level Design, leaving the System Requirements and Detailed Design steps remaining. These two steps can then be addressed quickly using two types of Decision Tools that address common work zone issues with simple criteria filters that help the user select appropriate SWZ Systems and sub components for each project.

The rising right side of the “V” Diagram could also be abbreviated somewhat due to the fact that some devices used in SWZs come pre-certified by the manufacturers. Due to the temporary nature of SWZs, this equipment is often re-used by contractors so their investment can be

amortized over several contracts. This makes the delivery of fully tested, reliable systems easier because they “worked the bugs out” the first time they were deployed. To ensure they get paid, these Integrators typically maintain a 10% spare parts inventory to minimize downtime.

The final step in the Systems Engineering process, System Validation, is achieved when the Contractor delivers the performance measures. Folding this validation data from the performance measures back into the Decision Tool criteria can produce a continuous stream of strategy refinements over the years ahead.

The timeline at the top of the ‘V’ Diagram in Figure 2 summarizes the stages of development for a typical new system. Because this timeline also resembles that of a typical highway construction project, we can take advantage of their parallel structures for scheduling the SWZ development steps.

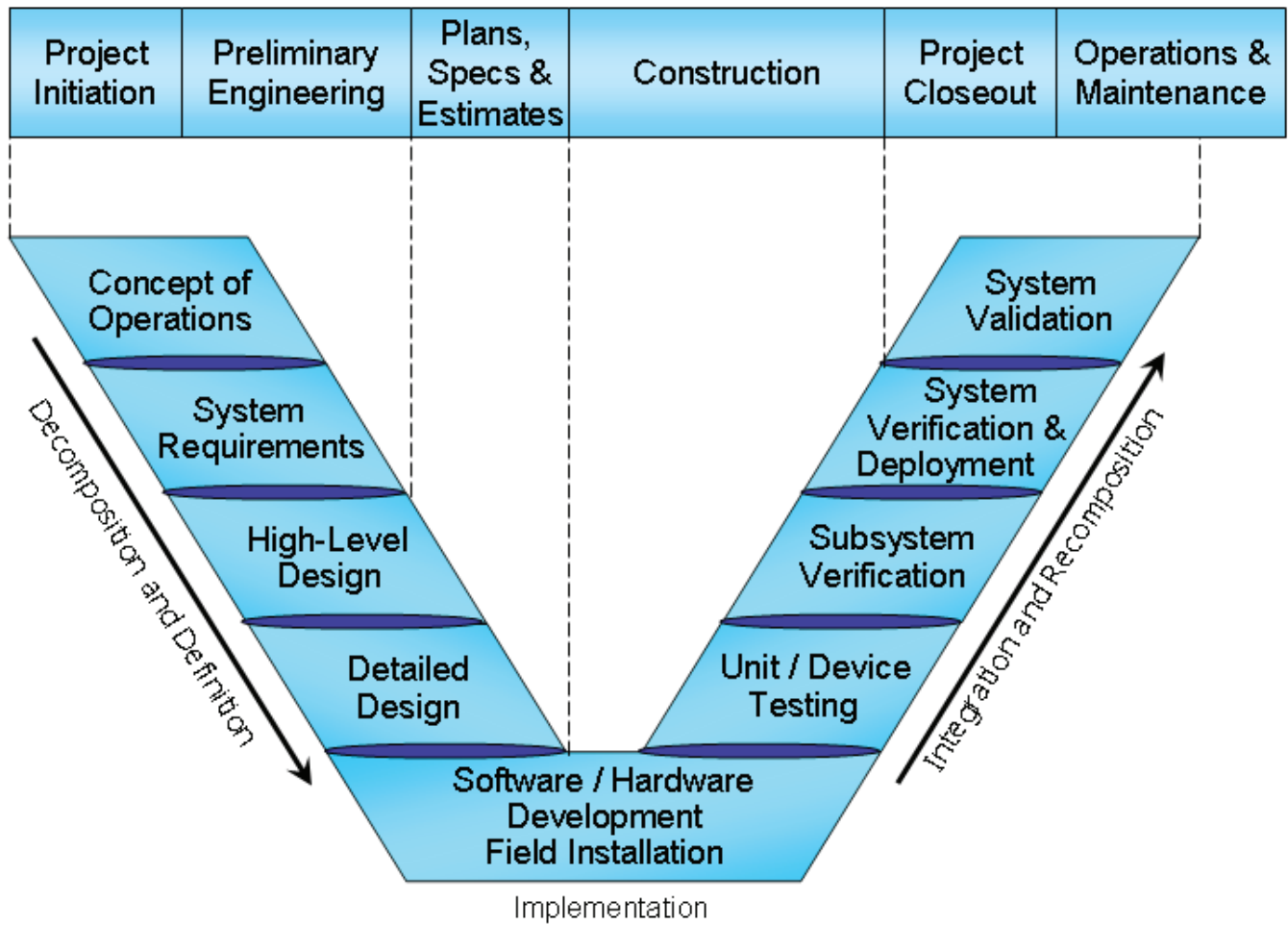

**Figure 1: System Engineering 'V' Diagram**  
 Modified from <https://ops.fhwa.dot.gov/publications/seitguide/section3.htm>

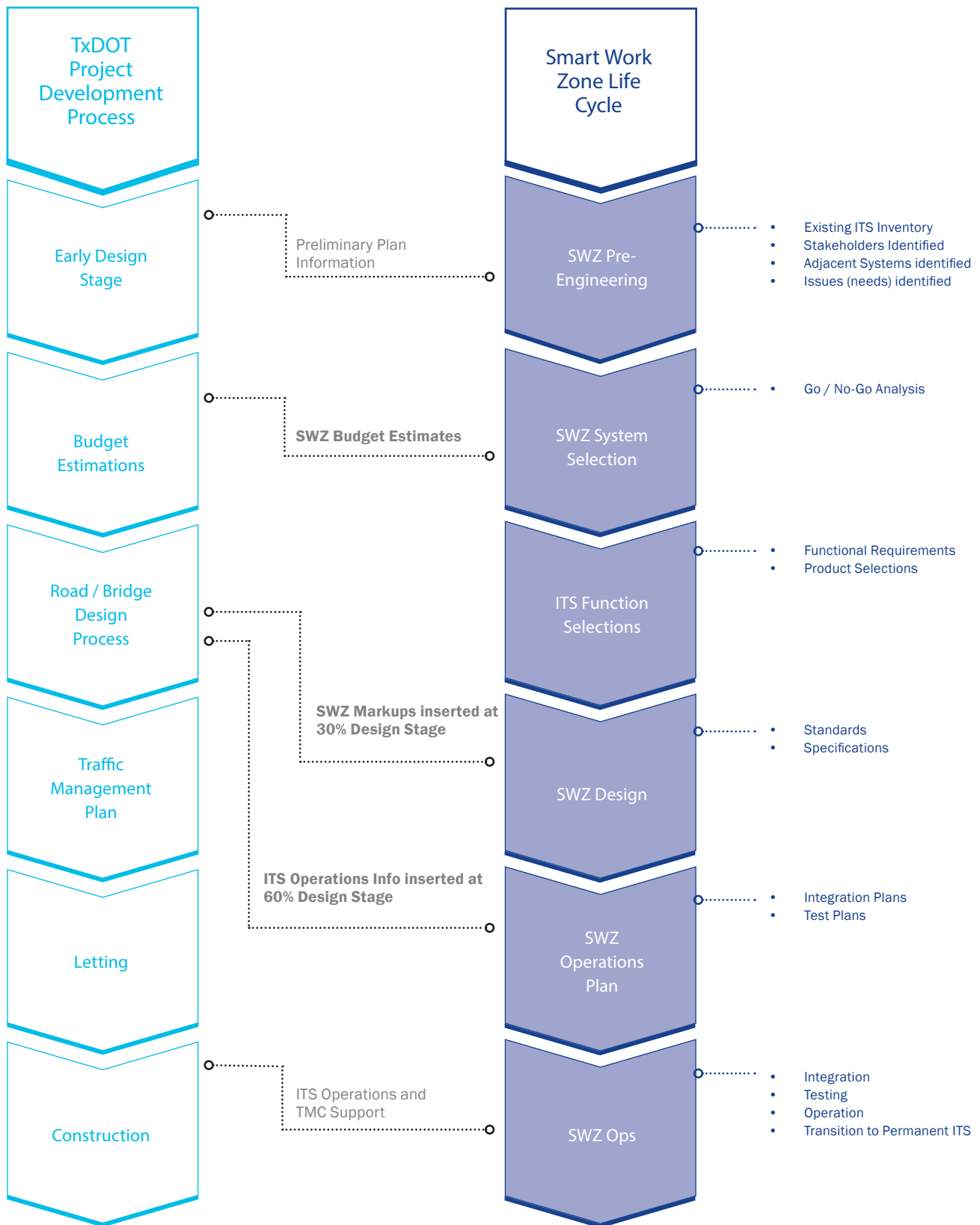

**Figure 2: Timelines showing TxDOT Construction Process and Smart Work Zone Life Cycle**

**Figure 2 illustrates several key strategies that facilitate the SWZ design process:**

- The Smart Work Zone Life Cycle on the right is the key to reducing the SWZ development time. Note that some of the steps actually occur before the physical road design even starts. This enables the SWZ Designers to identify project specific issues such as how to handle adjacent projects with overlapping boundaries, addressing concerns from emergency response agencies, and the concerns of local stakeholders who will be impacted by the project. Also note that the Systems selection occurs early relative to the road design. These Systems can be selected after the basic construction traffic pattern shifts have been determined. Getting this jump start on the SWZ Design process enables the remaining steps in the Smart Work Zone Life Cycle on the right to be sequenced in parallel with the remaining steps of the Construction Process on the top of Figure 2.
- Identifying the stakeholders early is a way of avoiding changes later in the process. Emergency response agencies and Traffic Management Centers (TMC) in particular have unique concerns that should be considered during the early design stage of a road, bridge or tunnel project. These organizations are already equipped to respond to highway incidents. SWZs can help them be more aware of traffic conditions within the construction zone areas by equipping them with video, incident detection and dashboards. For example, a vehicle speed gauge on a SWZ Dashboard can help identify when speed enforcement is truly necessary. This conserves their limited resources and addresses the fact that police presence can actually reduce throughput capacity in some cases. Giving these two groups real time situational awareness and performance progress reports enables them to quickly respond to incidents and to help apply countermeasures that prevent incidents from occurring in the first place.
- The ITS Design Stage in the SWZ Timeline in Figure 2 also includes provisions for addressing permanent ITS equipment issues. These may be new, replacement, or relocations of existing ITS technologies such as vehicle detectors or permanent dynamic message signs. If these are scheduled for delivery early in the construction sequence, they can be leveraged as useful components of the SWZ, minimizing the need to add temporary ITS equipment. Temporary wireless communication systems can even be installed to support operations until fiber can be installed which frequently must wait until grading and bridge structures are in place.
- Several of the SWZ Systems are designed for portable operation. These assembled products are pre-engineered to work as systems or to be linked together and operate globally across one or more work zones. Their portable design also enables easy relocation as traffic patterns change. These systems offer flexibility for re-use during subsequent projects, minimizing the development time and costs for those projects.

---

## 2. TxDOT Smart Work Zone Systems

---

A literature review was conducted on applicable Smart Work Zone documentation from federal agencies, other state departments of transportation (DOT), universities and research institutions to identify the most effective strategies for building Smart Work Zones. The work also included a search for available ITS technologies used to make work zones safer and more efficient.

Based on this literature review and SWZ project experience in Texas, TxDOT has identified six configurations of ITS applications for Smart Work Zone systems as options for the districts for project implementation. Table 1 summarizes the six priority System categories being emphasized by TxDOT.

Illustrations for each of the six Systems are presented on the following pages. Please note that the actual quantity, locations and spacing of the devices shown in each graphic may vary and are project specific. These conceptual drawings are only intended to suggest what equipment is typically included or considered as optional for each System.

The messages in the illustrations are displayed as examples. During construction these initial examples may be modified at the Engineer's discretion. It is also possible that some of these devices (eg. the PCMS) may be relocated as traffic patterns change, or if traffic conditions are different from what is expected during the design process. If that is likely

to happen, provisions should be made to pay for relocation costs.

Standard clear zone requirements will be necessary for all portable devices located on the shoulder. Standard construction signage (not shown on these illustrations) must also be included in the plans.

All of these systems have the capability of producing raw data that can be collected, communicated and archived for generating performance measures. These metrics can be presented in real time or in the form of reports for historical analysis. If these are desired, then provisions should be made in the specifications and bidding documents to cover the costs of producing these reports.

Whenever possible, the SWZ systems should be integrated into the existing ITS infrastructure. For example, existing Dynamic Message Signs upstream can be used as advance notification systems for Queue Detection or Travel Time Systems. In some cases, existing ITS devices may need to be modified or relocated as part of the project line items. When this occurs, it is important to make these changes to the existing infrastructure early in the construction process so they can be used during the remainder of the road/bridge project.

System	Description
Temporary Queue Detection System	System that continuously monitors traffic on the approaches to and within construction work zones to detect slowed or stopped traffic. This information is then presented to approaching motorists so they can make informed decisions.
Temporary Speed Monitoring System	System that uses sensors to measure vehicle speeds approaching work zone. Speed data is then immediately presented to the motorist.
Temporary Construction Equipment Alert System	System that delivers immediate information to motorists about construction vehicles and equipment that are entering the highway from a work zone.
Temporary Travel Time System	System that continuously monitors travel times through a work zone, and then presents this information to approaching motorists so they can make informed decisions.
Temporary Incident Detection and Surveillance System	System that uses sensors and/or video to detect crashes and other incident conditions within a work zone and then communicates that information to a local TMC and/or to emergency response agencies. The alerts are then confirmed remotely using live streaming video, snapshots or on-site personnel. This System can be used to provide critical information to responders who help them decide exactly what equipment to bring, how best to approach the incident, and any additional precautions that might be needed to protect themselves and the public.
Temporary Over-Height Vehicle Warning System	System detects vehicles or loads that are too tall to clear physical limitations such as low bridges in a work zone, and then conveys a warning message to approaching vehicles.

**Table 1: Smart Work Zone Systems**



## 2.1 Temporary Queue Detection System

### Problem Statement

This System addresses the problem of approaching vehicles suddenly being confronted with slowed or stopped traffic. This situation exists at the back end of any queue. It is particularly troublesome because that is a point of high risk that typically moves as the queue grows or shrinks. That movement makes it unpredictable for approaching motorists. This risk can increase with high traffic volumes, blind curves (vertical or horizontal), on/off ramps that

cause additional navigation burden for motorists, distracting urban environments, or rural environments where motorists may become inattentive.

### Countermeasures

Any strategy that increases an approaching motorist's attention to the driving task and awareness of the circumstances can serve as a countermeasure to minimize crash potential. Some transportation agencies conspicuously deploy motorist assistance vehicles or police officers at the moving edge of the queue with their vehicle warning lights flashing when conditions warrant. This works well, but is an expensive, labor intensive solution.

Queues typically form at lane closures and decision points. An ITS Queue Detection System is a strategy that can improve motorists' awareness of the situation, and increase their attention levels. The System includes a queue detector, a messaging system, a network to connect the two, and a connection to a TMC to make them aware of changing conditions. A data archiving system can be included as well to produce performance metrics that are useful for scheduling lane restrictions that minimize exposure, cost effective enforcement officer presence and effective planning for future construction zones. Figure 3 shows how the system is typically configured.

	Free Flow Condition	Travel Delays Or Slow Traffic	Long Travel Delays or Stopped Traffic
	Downstream Sensor Speed >45 mph	Downstream Sensor Speed <45 mph	Downstream Sensor Speed <25 mph
<b>Display 1</b> (7.5 miles from WZ)	Road Work Ahead	SLOW TRAFFIC X MILES	STOPPED TRAFFIC X MILES
<b>Display 2</b> (3.5 mile from WZ)	Road Work Ahead	SLOW TRAFFIC X MILES	STOPPED TRAFFIC X MILES

(See Standard Sheets for Temporary Queue Detection System for additional details)

**Table 2: Typical messages to be displayed on PCMS**

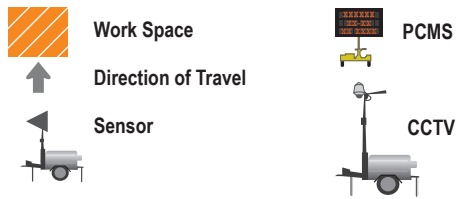
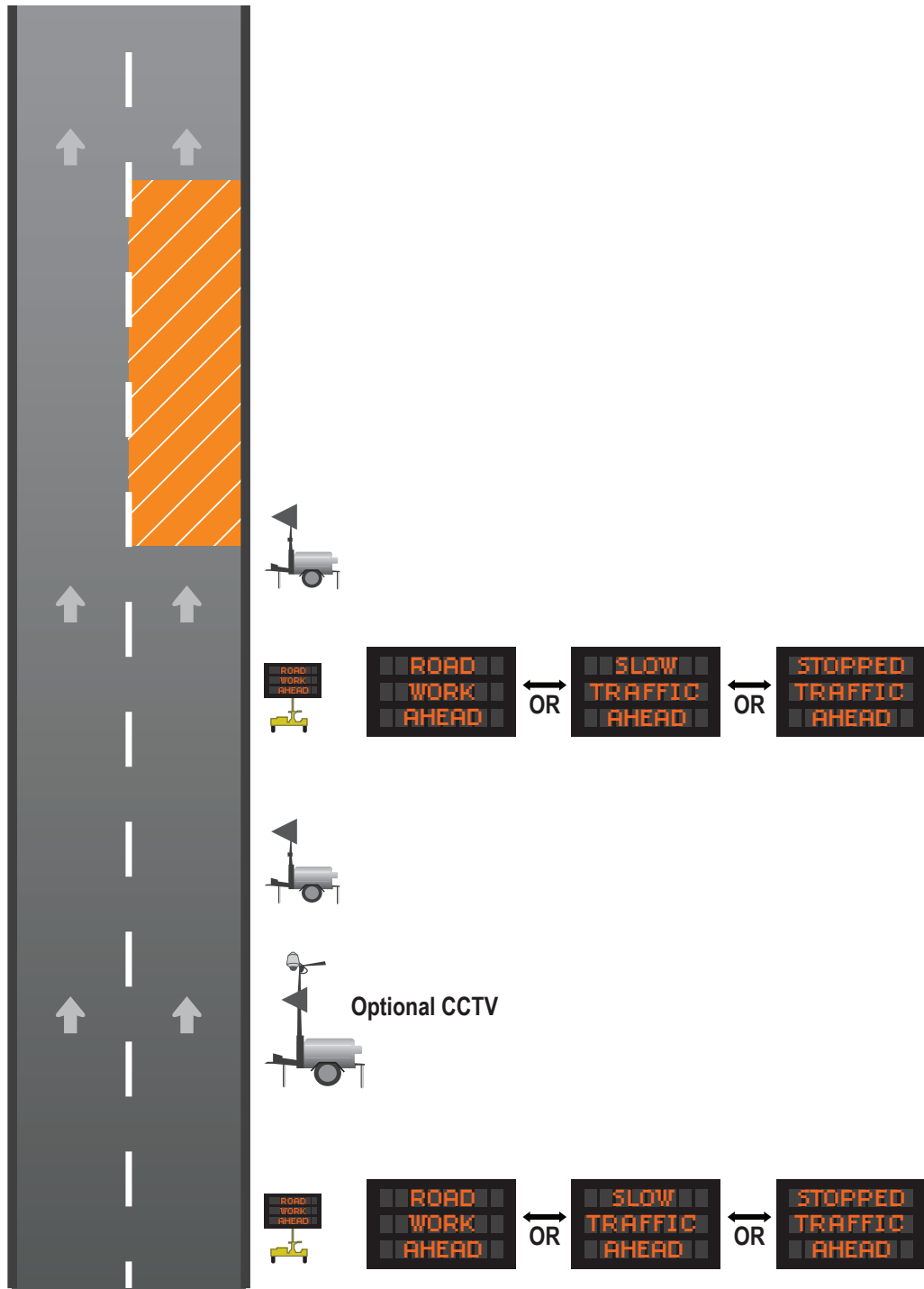

Notes:  
Layout is not drawn to scale  
number and location of devices will vary

**Figure 3: Temporary Queue Detection System**

The CCTV camera is optional for this application. If situational awareness of the work zone conditions is needed by a TMC, local enforcement authorities or the Contractor, then a trailer mounted CCTV can be included. (See Temporary Incident Detection and Surveillance System Graphic notes for dual purposing the CCTV cameras.) Table 2 shows typical messages message to be displayed on PCMS for each situation.

## 2.2 Temporary Speed Monitoring System

### Problem Statement

This System addresses the problem of high crash risk caused by unsafe vehicle speeds in construction areas. There are several key factors related to the Speed Monitoring System.

- The most obvious is excessive speed above what is considered safe for conditions. Typically this will be the posted or advisory speed limit, but can be lower during inclement weather, heavy traffic or other abnormal conditions. Both real time and archived speed data can be useful for enforcement to schedule speed compliance efforts, and for a TMC to invoke messages to motorists as a means for encouraging voluntary compliance. This metric is fairly easy to produce using radar or other forms of speed detection.
- A second, less obvious factor is non-uniformity of speed. When motorists are all traveling at the same speed they have fewer decisions to make in regard to navigating through work zone traffic. When a few motorists choose to travel at speeds significantly above or below the average, they increase the risk for themselves and for other motorists in their immediate environment who are forced to react to these unexpected conditions. This metric can also be produced with vehicle speed detection systems, but requires some additional processing to calculate the difference between individual vehicle speeds and the mean speed of the traffic stream – vehicle speed variability.

### Countermeasures

Any strategy that improves overall compliance with posted speed limits will effectively address this problem because it produces more uniform vehicle speeds that minimize the drivers' need to apply their brakes or change lanes. Police presence is highly effective, but is expensive, plus it also has a short "shelf life". Dynamic Messages or Speed Feedback Trailers can also be effective, especially if they are presented discriminately when conditions warrant so motorists maintain respect for the messages.

A Speed Monitoring System can be used in a Smart Work Zone to systematically address this problem. This ITS tool can improve motorists' awareness of the situation, and increase their attention levels. There are several ways this can be accomplished. The system can include one or more speed detectors, a messaging system, a network to connect the two, and a connection to a TMC and/or enforcement agency to make them aware of changing conditions. A data archiving system can be included to produce performance metrics that are useful for scheduling enforcement officer presence.

Stand-alone Speed Feedback systems are available to promote speed compliance. Figure 4 below shows an example. These systems are typically trailer mounted radar devices with signs that continuously produce brief messages or a simple two digit LED message. These portable units can also be configured with data archiving capability and remote communications to provide alerts for extreme speeds, hourly data archives or system status notifications.

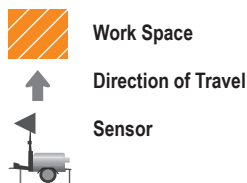

Notes:  
Layout is not drawn to scale  
number and location of devices will vary

**Figure 4: Temporary Speed Monitoring System**

Either the Feedback trailers or the Speed Detectors can be optional depending on need and project budget. The Detectors can also be dual purposed for use in the Travel Time System. Either of these devices can be configured to produce real time alerts to nearby enforcement officers regarding excessively high or low speeds. Historical (hour of the week) reports can also be generated to help enforcement optimize their officer assignments so they maximize their effectiveness. Periods of moderate traffic volume that have large variances in speed across adjacent lanes upstream of the taper are also cause for concern as they indicate a higher potential for crashes to occur. That set of circumstances places a heavy burden on motorist skills as they merge into a single file.

## 2.3 Temporary Construction Equipment Alert System

### Problem Statement

This System addresses the problem of construction vehicles entering into the traffic stream. This causes motorists to react, which increases risk for them and for other motorists behind them who have to react to sudden stops or slowdowns. A project's Traffic Control Plans typically try to avoid this problem, but there are some conditions when there is no other choice but to have material handling trucks use the mainline as their path to and from the work areas.

### Countermeasures

If conditions are such that these trucks must blend with traffic, one strategy is to have the barricaded area extend past the actual work area. This gives the material handling trucks a longer distance to match their speed with that of through traffic, making the merging maneuver safer and more obvious to the motorists.

A Construction Equipment Alert System, illustrated in Figure 5, can also address this issue. It consists of a truck detector, a message sign (or warning sign with flashers), and a wireless communication link to trigger the sign. These systems are typically stand-alone, so they do not usually have a link to a TMC.

One issue that must be handled is a means for distinguishing between these trucks and all other equipment that moves within the work zone so that false triggers do not occur. This can be handled by carefully limiting the detection zone, or by having a vehicle-to-infrastructure (V2I) communication device in each construction vehicle that will be leaving the work area and entering the traffic stream.

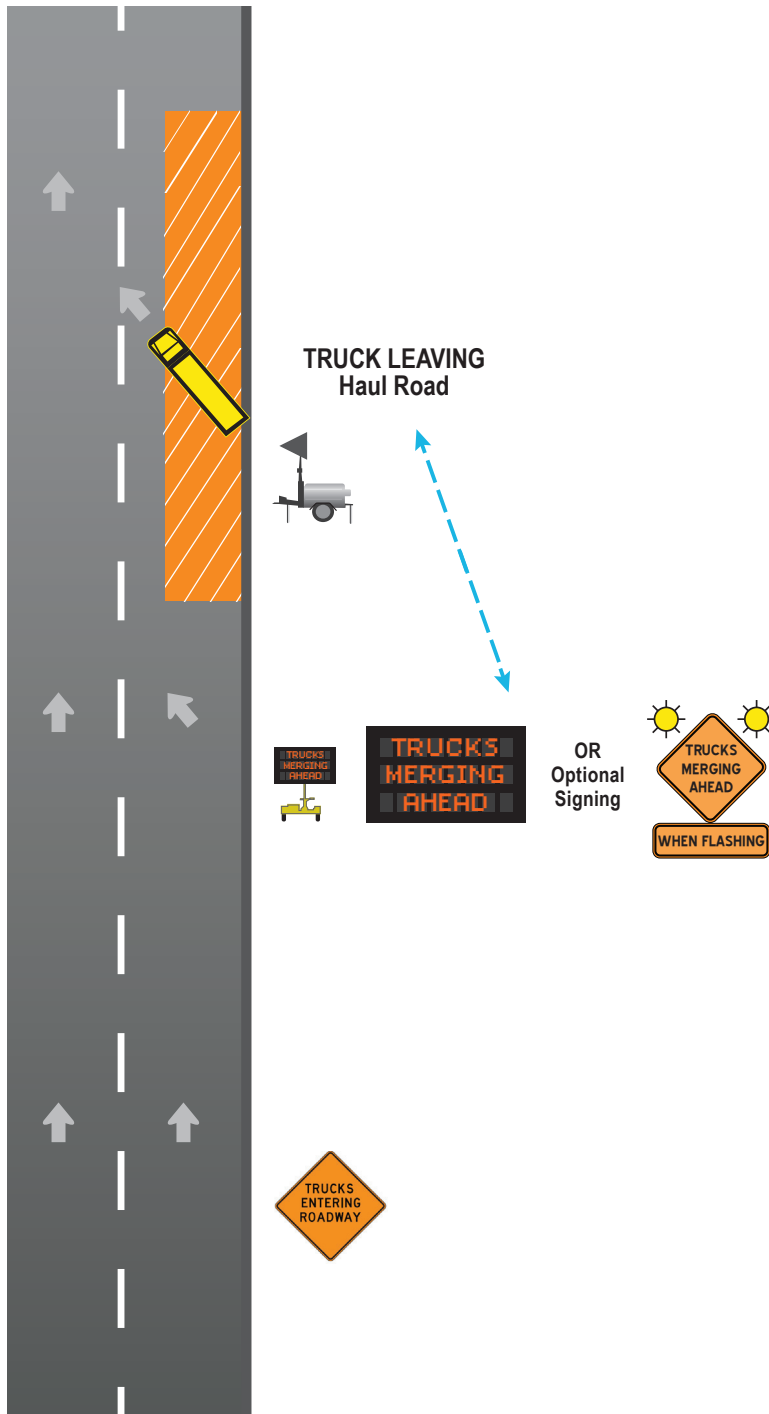

-  Work Space
-  Direction of Travel
-  Sensor
-  PCMS
-  Wireless Communication
-  Static Signs (CW27-1T)

Notes:  
Layout is not drawn to scale  
number and location of devices will vary

**Figure 5: Temporary Construction Equipment Alert System**  
The communication system that links the sensor to the Warning Sign must be a point to point wireless device because the sign must respond immediately and reliably to the detection call. Cellular communications should not be allowed.

## 2.4 Temporary Travel Time System

### Problem Statement

This System addresses the problem of motorist delay frequently caused by work zones. When motorists experience delay, they tend to overestimate their additional travel time experience, causing aggravation that can lead to reckless and dangerous driver behavior. Travel Time information can be provided in advance of the work zone so motorists can make informed decisions and set realistic expectations.





### Countermeasures

Giving motorists the current travel time to a reference point beyond the work zone can alleviate some of the frustration that motorists experience.

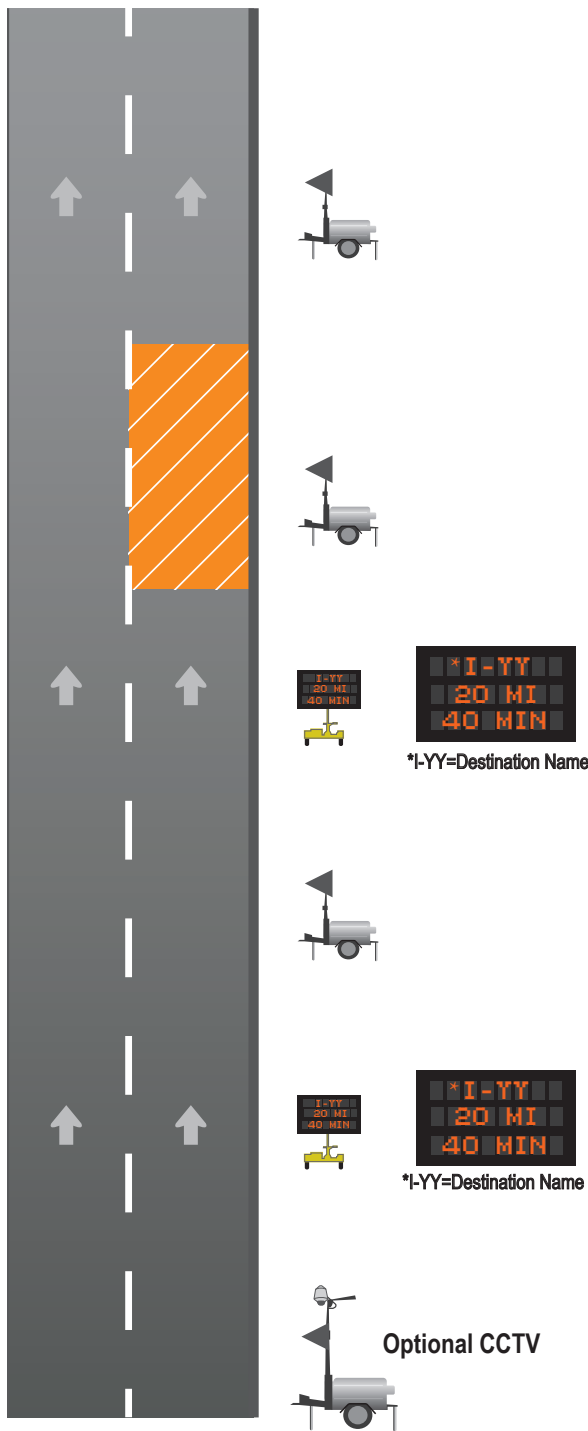
The equipment consists of a detection system that measures the travel time through the work zone, and a communication system to one or more message boards or travel time signs, see Figure 6. During the system design, the Engineer should identify project specific destination names for each PCMS. Typical destinations will be shown in Chapter 5. The System provides information that clarifies motorists' expectations if they choose to travel through the work zone, or encourages diversions along alternate routes if that is a better choice.



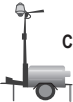

	Work Space		PCMS with Optional Sensor
	Direction of Travel		CCTV
	Sensor		

Notes:  
 Layout is not drawn to scale  
 number and location of devices will vary

**Figure 6: Temporary Travel Time System**

Several different forms of detection are available to provide the raw speed data needed by the system to calculate the travel time or delay values that are displayed. These can include devices such as radar, video analytics, or Bluetooth. An alternative to physical detection equipment is crowd sourced data that uses vehicle GPS navigation system data samples to calculate link travel times. Besides the non-invasive nature of probe data, it can also be used to monitor traffic flow on alternate routes, enabling upstream messages to motorists advising them of their best route choice options.

## 2.5 Temporary Incident Detection and Surveillance System

### Problem Statement

This System addresses the problem of higher than normal crash risk in most work zones and also includes the approaches to work zones where traffic is affected. This problem may always exist simply because work zones increase demand on motorist skills. When safety service patrols are included in work zones, the personnel operating those programs need details about each disabled vehicle or crash site (eg. Size of vehicle, orientation of vehicle, fuel/cargo spills, etc.) so the appropriate response vehicles/equipment can be deployed effectively.

### Countermeasures

Any means for improving the situational awareness of emergency responders will reduce the time to detect, respond and clear incidents. Incident Detection and Surveillance Systems typically include incident detection and video surveillance equipment, see Figure 7. These tools are most often connected a TMC that contacts the appropriate agencies to respond to incidents and notify the public. Timely response to clear an incident reduces the probability of a secondary incident which may have severe consequences.

This information can also be used by enforcement agencies to incorporate countermeasures that reduce the occurrences of incidents in the first place. When conditions that increase crash risk exist such as road maintenance, severe weather, debris on the roadway or certain traffic flow conditions, the conspicuous presence of a police officer can usually smooth the flow rate and increase motorists' attentiveness.

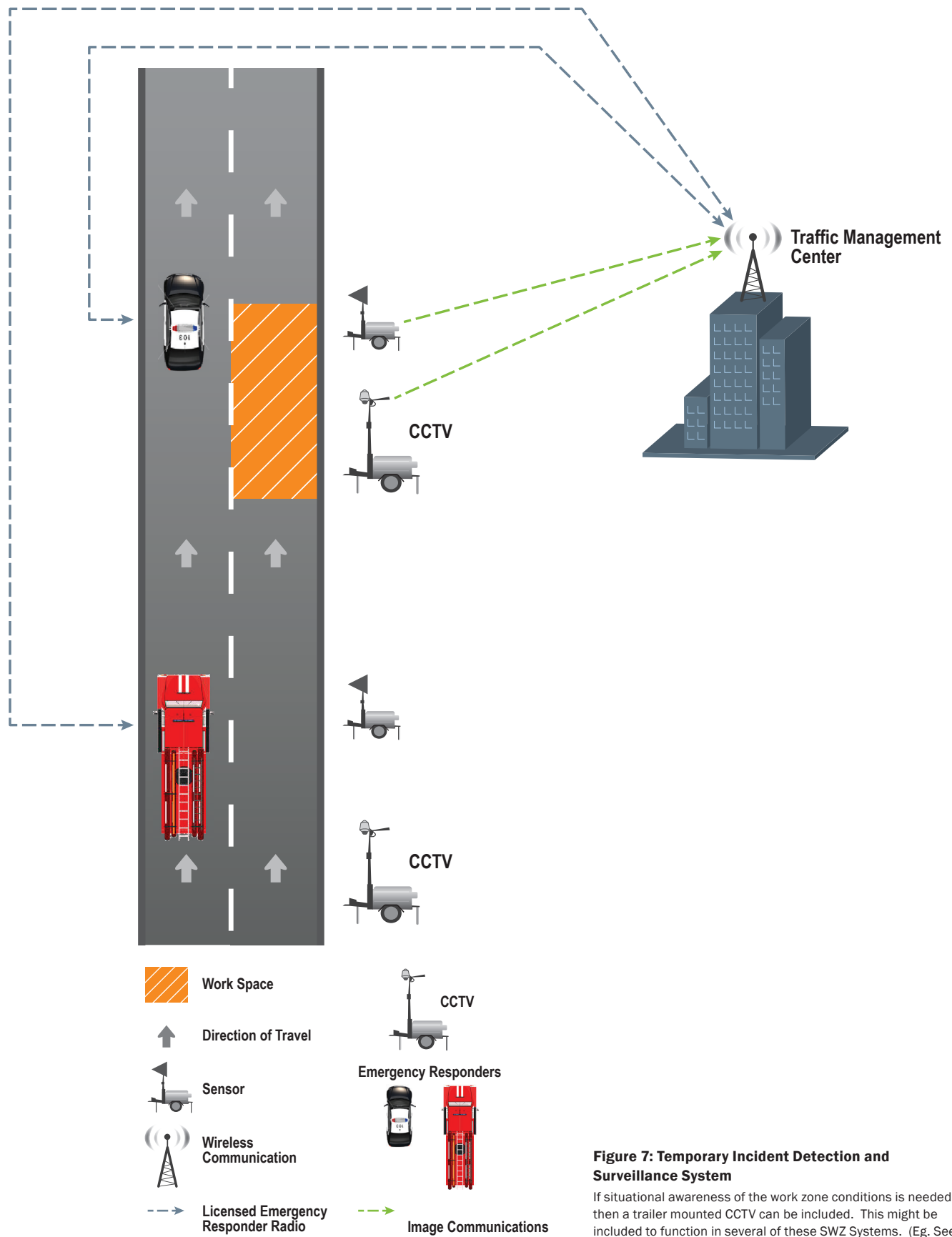

**Figure 7: Temporary Incident Detection and Surveillance System**

If situational awareness of the work zone conditions is needed, then a trailer mounted CCTV can be included. This might be included to function in several of these SWZ Systems. (Eg. See Queue Detection System Graphic notes for dual purposing the CCTV cameras.)

Notes:  
Layout is not drawn to scale  
number and location of devices will vary

## 2.6 Temporary Over-Height Vehicle Warning System

### Problem Statement

This System addresses the problem of vehicles striking low structures. Although most Interstate facilities meet minimum height standards, there sometimes are low structures on other State Highways and issues with arch bridges when shoulders are used as temporary travel lanes. While these incidents are rare, they tend to be catastrophic when they occur. Real time vehicle height detection and driver notifications can be used to address this problem.

### Countermeasures

In a few cases where traffic is traveling at very low speeds, simple, low-tech horizontal height bars or dangling chains can be used to alert a driver that their vehicle is too tall to navigate under the low structure ahead.

For most other cases, an electronic detection system is required to identify vehicle height problems. Twin light beam technology has been used successfully by a number of states as an effective application for detecting these tall vehicles or Over-Height cargo. Dynamic Message Boards or fixed signs with flashing beacons are triggered instantly when any Over-Height detection occurs, see Figure 8.

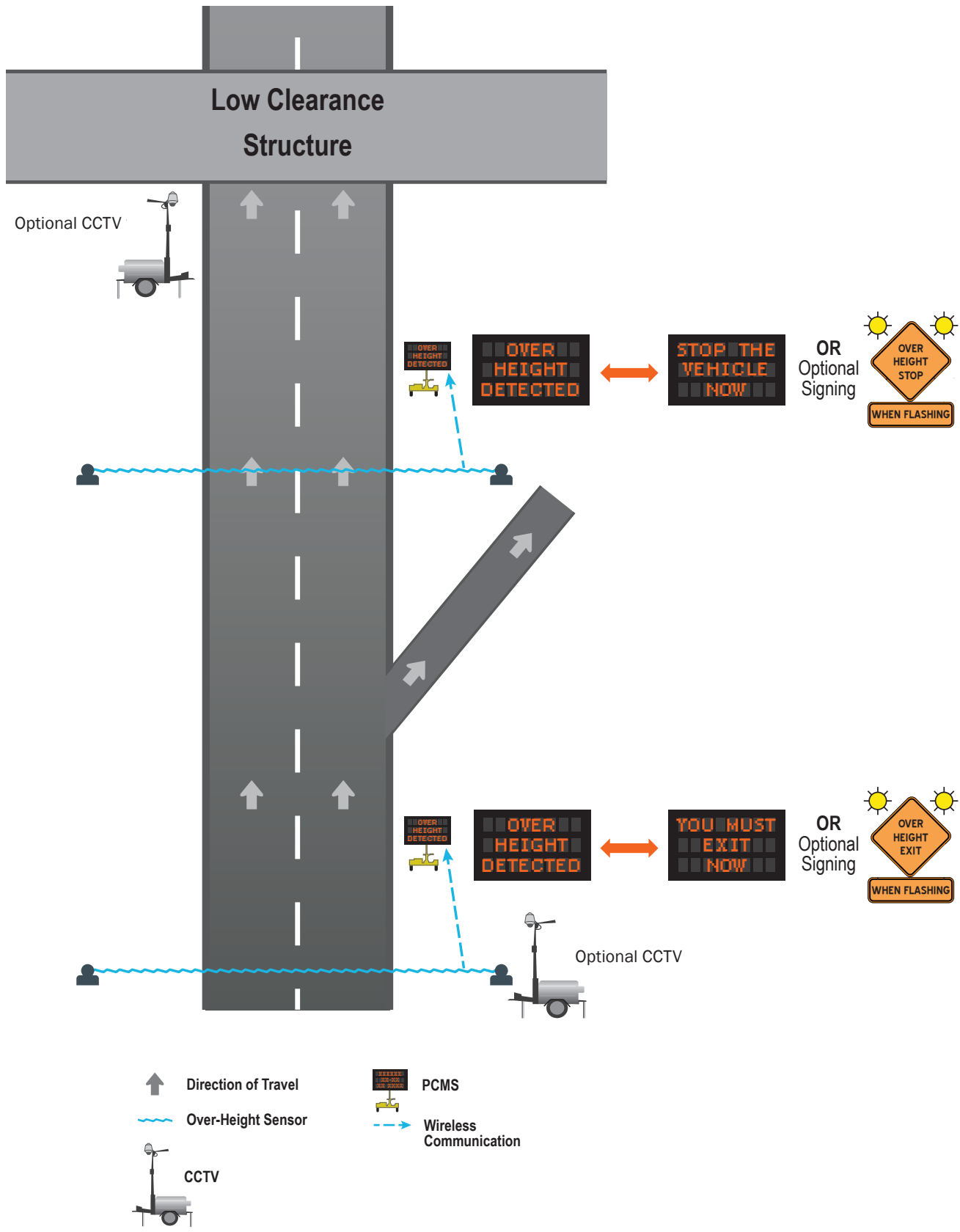

Notes:  
Layout is not drawn to scale  
number and location of devices will vary

Figure 8: Temporary Over-Height Vehicle Warning System

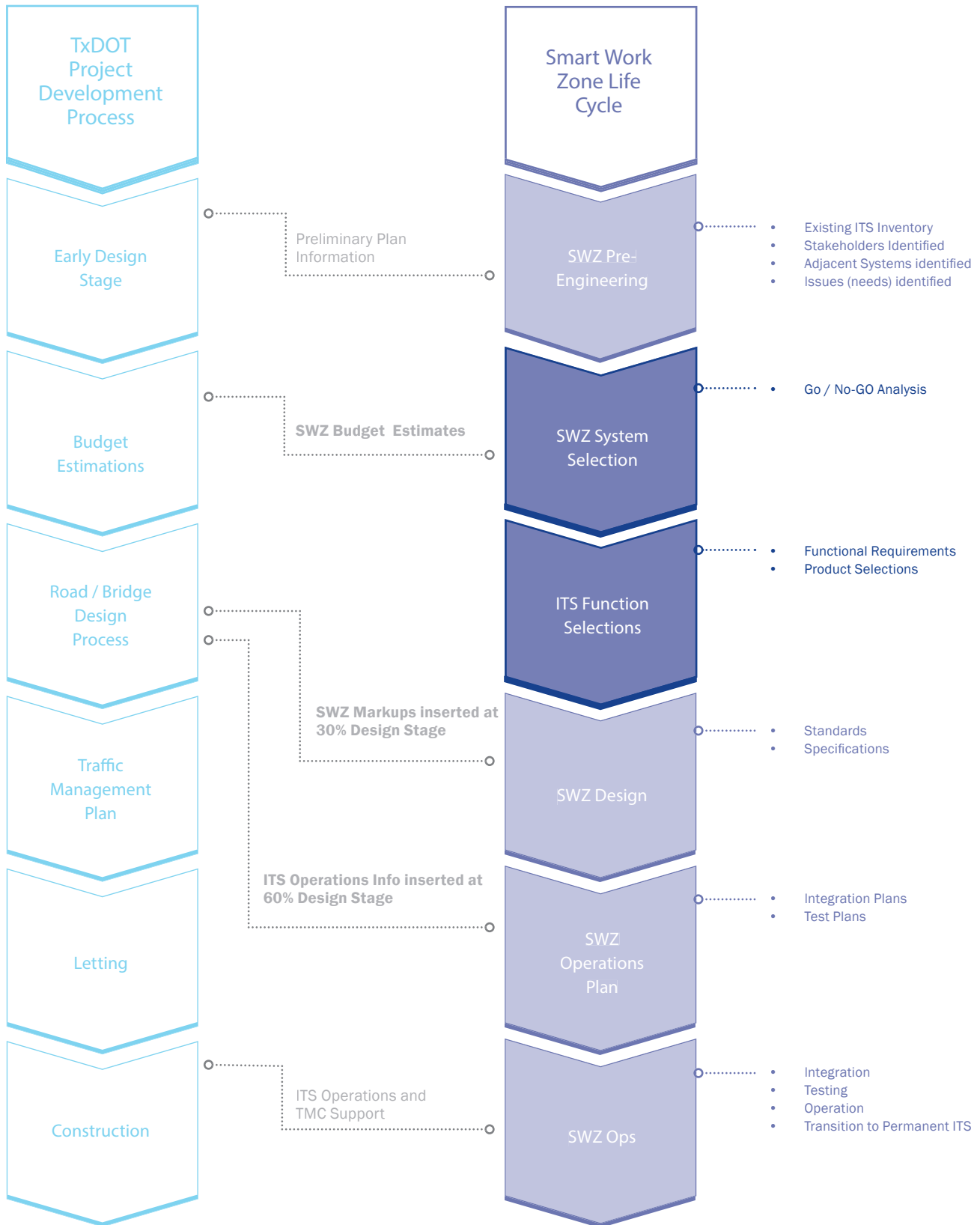

## 3. Selection Procedure for Smart Work Zones

### 3.1 Identification of Work Zone Data Needs

To select proper SWZ Systems requires full understanding of the project characteristics. Several key elements are presented below that need to be taken into consideration in decision making and designs. This data is needed before completing the decision tool workbook scoring criteria shown in Appendix A.

#### Duration of the Work Zone

Statistically, the longer a work zone exists, the higher the impact on traffic conditions and crash risks. Very short term projects such as lane closures for only a few hours or days may not justify the expense of a SWZ System unless there are extenuating circumstances.

#### Highway function class and traffic volumes

Traffic volumes and road capacity directly affect travel time, headways and uniformity of speeds in a traffic stream.

#### Impact from local traffic generators

Local traffic generators such as sports arenas, industrial centers with a large population of employees or material movements, or other attractions can produce sudden traffic at the entry/exit points to the highways that feed these facilities. If a work zone is operating near capacity, traffic generated by those facilities can produce severe delay and longer queues than expected during normal operating hours.

#### Estimated queue length

This is the most important factor for determining the need for a Queue Detection System. The extent to which a work zone produces queues can be used as a gauge for a Go/NoGo decision on this System. The lengths and durations of the queues can be used to compare different projects to prioritize when budgets are tight. Queue lengths can also be a factor for determining which hours of the week a lane can be closed if the nature of the work allows for short term lane closures.

#### Sight distance at back of queue

Limited sight distance at the back of queues reduces motorists reaction time to the presence of stopped traffic ahead.

#### Existing traffic issues

The mainline roadway itself may have unusual characteristics such as a higher than normal incident rate, gridlock or exit ramp backups due to connecting arterial spill overs during peak hours, rail crossings interrupting exit ramp flow immediately after the ramp leaves the mainline, or a tendency to flood during high water circumstances.

#### Availability of alternate routes

Traffic can be distributed across alternate routes when available and feasible, which reduces the demand and, therefore, the queue potential. The feasibility of any proposed alternate should be evaluated first. Is the proposed alternate comparable in terms of roadway functional class? For example, can the alternate route handle heavy truck traffic? When alternate routes are not available, ITS systems become more important to maintain safe speeds and maximum capacity.

#### Merging conflict or hazards on the approach to work zone

Conflicts can cause sudden changes in speed, creating a hazard for trailing and merging motorists.

#### Complex traffic control layouts

Situations like multiple crossovers, sharp curves, lane splits, etc. challenge motorists' skills, leading to higher crash rates.

#### Constraints for emergency responders

The construction process may limit fire, police, ambulance or other emergency response agencies' ability to reach an incident site. This can include very narrow or no shoulders, long stretches of roadway with no crossovers, International borders making turn arounds difficult, narrow lanes, or any other factor that limits their access during the construction process.

#### Chronic speeding issues

Some roadways have a chronic history of extremely high (eg. aggressive motorists) or extremely low (eg. non-motorized vehicles) speeds. These situations can increase the risk potential for crashes to occur.



**Large speed variations**

Uniform traffic flow is the goal for a work zone, which occurs when motorists are traveling at approximately the same speed and their headways are adequate to enable them to react successfully for sudden changes such as a stopped vehicle ahead.

**Adjacent/consecutive project**

When multiple construction projects are strung together effectively creating one large work zone, the combination of projects should be considered as one project in determining the need for SWZ System.

**Scattered, short term projects**

Projects like bridge painting can surprise motorists.

**Extreme weather condition**

Safety can be a big concern where the work zone is operating in an area with a known history of sudden extreme weather conditions such as ice, flooding, windstorms, sandstorms, or a project duration that covers several harsh weather seasons.

**Connected Vehicle**

It is anticipated that when a few percent of the population of vehicles are connected vehicles, they will effectively influence the overall behavior of the traffic stream. Examples include more uniform speeds, fewer incidents and improved navigational guidance for trailing vehicles that are not equipped with vehicle to roadside communication systems.

**Existing ITS Systems**

Existing ITS systems can be leveraged when the work zone falls within the jurisdiction of a Traffic Management Center (TMC). SWZ equipment can be brought in and connected to the TMC as if they were an extension of the normal TMC operations. It is a cost-efficient strategy that takes advantage of the TMC's ability to notify emergency responders, publish traveler information to an extensive list of media, and process any performance metric data that is being produced by the SWZ devices. This strategy expands the TMC staff's situational awareness.

**Heavy vehicles**

The percentage of heavy vehicles can be a significant factor for degrading speed uniformity due to the tendency for trucks to travel at lower speeds than smaller vehicles, causing a frequent speed differential. Their physical size also occludes other motorists' view of the approaching traffic conditions.

**Construction vehicle entering the highway**

Construction vehicles entering mainline traffic disrupt traffic flow. Motorists need to be aware of this conflict ahead of time.

**Over-Height Vehicle / Low Clearance Structure**

Although most interstate structures meet minimum design standards for vertical clearance, circumstances such as temporary false work, shoulders being used as driving lanes under arch bridges, or temporary detours that use local roads with low structures can cause temporary vertical clearance hazards.

## 3.2 Selection Process & Criteria

Table 3 shows the key elements to be considered when determining if a specific SWZ System is needed or not. ITS devices can be assembled into groups called Systems that accomplish specific objectives. Because the criteria for system selections are unique to each project, a SWZ Decision Tool has been developed to streamline the SWZ selection process. These can be found in the Excel Decision Tool Workbook included in Appendix A. The Decision Tool enables an overall Smart Work Zone Go/NoGo decision to be made by scoring the extent to which each criterion in Section 3.1 above is satisfied. The Go/NoGo Decision Tool automatically assigns those values to each of the six SWZ Systems to produce a total score for each system and presents a summary in the Summary Tab. This produces a logical basis for including any combination of SWZ Systems into the project design, which effectively defines the SWZ Scope.

Because the queue area in front of a work zone is typically the area of highest risk for crashes to occur, the estimated queue length is an important factor in the decision process. The metric recommended for this is queue length. This is a factor in several of the SWZ systems, particularly the Queue Detection System. To produce a realistic estimate of the queue, three options are recommended:

1. If a traffic modeling program is available, it will produce the most realistic estimate of the queue.
2. TxDOT also has an internally available tool called Q-DAT which can estimate queue length. For access to this tool, please contact Traffic Operations Division, Traffic Engineering Section, Policy and Standards Branch.
3. A third option is a lookup table in Appendix B. The Average Annual Daily Traffic (AADT) value for the project is located among the threshold values for different queue lengths to determine the scoring for the Queue factor in the Go/No-Go Decision Tool. These two tables were developed based on a single case study and a single day traffic count. The look-up tables are intended to only provide an approximate queue length.

With the Go/NoGo tool, the designer should use engineering judgement to determine if smart work zones systems are needed. Once the Systems have been selected, an approximate cost estimate can be produced.

Appendix C includes some sample cost data from projects that included various SWZ elements.

Scoring Factors	Systems					
	Temporary Queue Detection	Temporary Speed Monitoring	Temporary Construction Vehicle Alert	Temporary Travel Time System	Temporary Incident Detection & Surveillance	Temporary Over-Height Warning
Duration of the Work Zone	X	X	X	X	X	
Highway Function Class and ADT	X	X	X	X	X	
Impact from local traffic generators	X	X		X	X	
Estimated Queue Length	X	X		X		
Sight Distance at back of Queue	X	X			X	
Existing traffic issues	X	X	X	X	X	
Availability of Alternate routes	X			X		
Merging conflict or hazards on the approach to work zone	X	X			X	
Complex traffic control layout	X	X	X		X	
Constraints for emergency responder					X	
Chronic speeding issues		X	X		X	
Large speed variations		X	X		X	
Adjacent/consecutive project	X	X		X	X	
Scattered/short term project	X	X			X	
Extreme weather condition	X			X	X	
Connected vehicle	X	X	X	X	X	
Existing ITS Systems	X			X		
Heavy vehicles	X	X	X	X	X	
Construction vehicle entering		X	X			
Over-Height vehicle/Low Clearance Structure						X

**Table 3: Selection Process and Criteria**

THIS PAGE HAS INTENTIONALLY BEEN LEFT BLANK

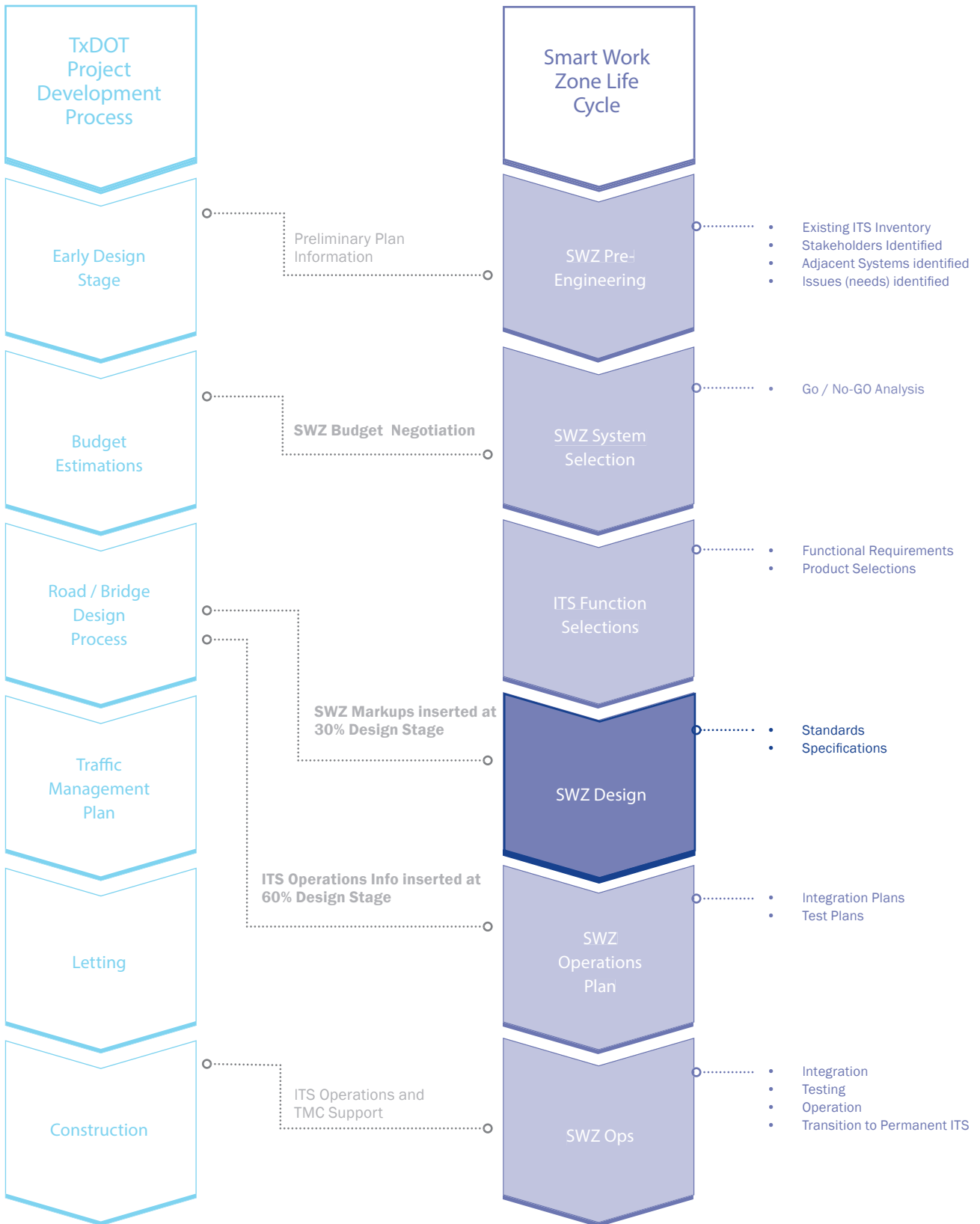

---

## 4. Smart Work Zone Design

---

### Design process

Before a SWZ design begins, certain project specific information needs to be identified. This research occurs at an early stage when the schematic design is being performed, and should include input from the appropriate district staff who are familiar with the nature of the roadwork being planned, along with any concerns that will affect the work. A detailed view of this process was introduced in Section 4. At this early stage, the specific SWZ systems are selected based on project needs. The Go/No-Go Decision Tool can assist with this initial process. After determining the specific SWZ systems to be used, the functional requirements for each system need to be determined along with cost estimates. High level SWZ design details should be inserted into the road/bridge design process beginning around the 30% design phase.

The SWZ operations plan should be developed at the 60% design stage, including the integration and test plans. Introducing the integration and testing aspects of the SWZ at the 60% stage enables the designers, the TMCs and any other stakeholders such as the emergency response agencies to prepare for their involvement with the SWZ well in advance of the letting. This also gives them an opportunity to suggest refinements in the plans while there is still time to get changes made.

It should be noted that the SWZ design is different from the permanent and temporary ITS designs. Design of permanent ITS is for equipment that will remain in place after construction is completed. This can include new or upgraded ITS equipment that will be part of the permanent ITS infrastructure. Temporary ITS design refers to temporary modifications to permanent ITS equipment intended to keep them operational during the construction. For example, this could include temporary power or communications while those utility services are being rerouted. It could also include relocation of the existing, permanent devices. SWZ design is intended to provide temporary (often portable) systems that address traffic and safety concerns only during construction periods. However, if applicable, SWZ equipment can be used to temporarily support the permanent ITS operations. Permanent ITS equipment can also be incorporated into a SWZ system if it makes sense to use it. The goal is to coordinate all of the ITS systems that can be useful in a work zone.

### Design Plans

The designer should at a minimum include the following details in the design plans:

- Specified locations for system components to be installed (and relocated if applicable).
- Time frame and duration of the system being implemented. If system is to be relocated, specify the duration of all locations before removal.
- Frequency of performance report . If it is not specified, it will be reported monthly.
- Details on integration of the system if the system need to be integrated with a TMC, emergency responders or any other platform. It includes what data to be integrated, frequency, format, and who to integrate the data with among other things.
- Specifications, standard sheets, and any supporting drawings.
- Bid quantities

## 4.1 Temporary Queue Detection System

### Design Requirements

The following requirements need to be addressed in the design documentation and specifications:

- A basic system should include at least 1 sensor/per mile, 1 Portable Changeable Message Sign (PCMS) per sensor and an operating system
- Sensor coverage in terms of roadway approach width, and length of anticipated maximum queues
- Automated continuous data acquisition if performance measures are needed or if a TMC desires situational awareness is desired
- Message Delivery latency time
- Battery recharge rates on solar powered systems
- Real time data transfer connectivity to various agencies or a TMC
- Requirements for any archived data transmission to a TMC
- System operation hours - typically 24/7
- Clearly define if there will be concurrent deployment of systems during the project.
- Identify relocation of the system during project phases.
- Error detection-correction mechanisms and clearly defined consequences when failure rates are excessive

### PCMS Operations

PCMS should be dedicated exclusively to the temporary queue detection system and not display other messages. PCMS are recommended to display ROAD/WORK/AHEAD message when the system is not activated or there is a system failure.

### Optional Functions

Project specific circumstances may warrant some optional features for Queue Detection Systems. These can include the following.

Lane Merge Systems come in two categories: Early Lane Merge and Late Lane Merge. The Early version works well in situations where there is an abundance of roadway upstream such as in rural applications. The Late version addresses the issue of ramps interrupting the lane merging operations. These two systems should only be used when queues are going to exist. The primary advantage is that they smooth the merging process which can increase capacity, reduce crash rates due to erratic merging, and improve headway compliance-an additional safety measure. They also provide enforcement officers with a clear means for defining merging violation. The data generated by these lane merge systems can also produce some useful information that might lead to the potential for crash risk prediction.

CCTV can be useful in a Queue Detection System because they can be used by a TMC, the Contractor, or enforcement personnel to confirm the system is operating properly, to identify incidents, or to spot disabled vehicles. Because the queuing area is one of the most frequent areas for crashes to occur, having a CCTV pointed at the queue can be very useful to incident response operations as they acquire information about the nature of the incidents such as, truck involvement, orientation of the vehicles after the incident, fires or spills, number of vehicles involved, etc.

Video analytics can be used to count vehicles, detect speeding, assess lane changing frequencies, and detect errant vehicles leaving the roadway. To a limited extent, it can also detect wrong way vehicles.



Data collected	Metrics	Use
1. Equipment stoppages and resumptions	Time stamps of equipment stoppages and resumptions per day (required).	TxDOT use to evaluate overall performance of the system.
2. Speed sampling (typically use the highest speed detected in an approaching group of vehicles during a sampling period)	Speed sampling periods	TMC use to trigger queue warning message changes
	Speed bins and distribution curves per hour, and/or per day	TMC use to increase motorist awareness of potential queue crashes;
3. Time and duration of each active queue alert message		Contractor use to make changes to traffic pattern changes or scheduling road work,  TxDOT Public Relations use for website updates and news media pushes.  TxDOT use to assess impacts of the roadwork for current and future contracts,  Enforcement use to optimize their scheduling of police presence.
	Number of times of queue alert message type was active and its duration per week. (required)	TxDOT use of message dwell time for determining the impact of a work zone (or of a contractor’s work procedures). This can also be used as a means for determining what hours a lane can be closed if serious congestion issues routinely arise for specific hours of the week.
	Headway variance (if individual vehicle speeds are detected)	TMC or possible research analysis use of headway distributions to predict current crash risk. (Non-uniform headways place more of a burden on the motorists’ skills.)
	Mobile source emission assessment (if individual speeds are detected)	Traffic Air Quality modeling of mobile source emissions in real time using only vehicle detector data.

**Table 4: Temporary Queue Detection System Performance Measures**

## 4.2 Temporary Speed Monitoring System

### Design Requirements

The following requirements need to be addressed in the design documentation and specifications:

- A basic system should include at least 1 Display Panel and sensor
- Sensors need to be located to provide situational awareness of the critical areas within the work zone and its approach
- Automated continuous data acquisition if performance measures are needed
- Battery recharge rates on solar powered systems
- Real time data transfer connectivity to various agencies or a TMC
- Format and frequency requirements for archive data transmission to a TMC
- System operation hours - typically 24/7
- Error detection-correction mechanisms
- Speed sampling rates
- Clearly define if there will be concurrent deployment of systems during the project

### Optional Functions

Project specific circumstances may justify some features for Speed Monitoring Systems. These can include the following.

Combination Radar/CCTV systems are also becoming available. These systems enable an enforcement officer downstream (typically at the outlet of a work zone) to view a live video of approaching traffic with individual vehicle speed tags superimposed on violating vehicles. This gives the officer probable cause for enforcement action and is not considered automated enforcement, so it is legal in every state. The officer can then re-measure the vehicle's speed using hand held radar as it arrives at the officer's location near the outlet of the work zone, which is a safe haven for issuing tickets.

GPS Navigation System Data can be purchased by the agency as an alternative to physical speed detectors. This provides a low cost means for assessing overall speed at a frequency of 5 to 15 minute intervals. This may be enough to support enforcement scheduling, identify incidents, and assess overall work zone performance. This can also be an effective means for assessing speed issues at work zones that are of short duration and scattered across the state, such as bridge painting operations. An additional benefit of this approach is that it can provide comparative speed assessments across the work zone vs. alternate routes.

Data collected	Metrics	Use
1. Equipment stoppages and resumptions	Time stamps of equipment stoppages and resumptions per day. (required)	TxDOT use to evaluate overall performance of the system.
2. Timestamp of each new speed reading collected (regardless of detection type)	Speed bins and distribution curves per hour, and/or per day. Frequency of total speed violations per month. Calculated 85th percentile speed per hour of each day. (required)	TMC and researchers may possibly use speed variance to predict crash potential (The greater the variance, the greater the risk of motorists making bad choices for lane changes and tailgating).
3. Radar feedback trailer detection with speed display	Radar Feedback to motorists (and archived speed/timestamp records)	<p>Motorists use to be reminded of the reduced speed limit and their current speeds.</p> <p>TMC use to assess effectiveness of speed and warning signs.</p> <p>Enforcement use to determine optimal times to be present and encourage uniform speeds through the work zone.</p>

**Table 5: Temporary Speed Monitoring System Performance Measures**

## 4.3 Temporary Construction Equipment Alert System

### Design Requirements

The following requirements need to be addressed in the design documentation and specifications:

- A basic system should include at least 1 sensor and at least 1 Warning Device
- Sensor coverage areas to ensure that only vehicles entering the traffic stream trigger the messages
- Communication between the construction vehicle detector and the message board must be point to point wireless because the transmission time must occur in milliseconds. Cellular communications will not be fast enough
- Battery recharge rates on solar powered systems
- The system will typically be a stand-alone system with no connectivity to a TMC
- Format and frequency requirements for archive data if desired by TxDOT
- System operation hours - typically 24/7
- Error detection-correction mechanisms
- Removal/Relocation of the system if/when the access roadway is eliminated or relocated
- Clearly define if there will be concurrent deployment of systems during the project

### PCMS Operations

If PCMS is used, it should be dedicated exclusively to the construction equipment alert system and not display other messages. PCMS is recommended to display WATCH/YOUR/SPEED message when the system is not activated. PCMS is recommended to display a blank message, when there is a power failure or communication problem.

### Optional Functions

Project specific circumstances may warrant some optional features for the Construction Equipment Alert Systems. These can include the following:

Short range transponder or bluetooth based detection devices may be needed if other construction equipment is likely to be in close proximity to the vehicles leaving the work area, making it difficult for a detector such as radar to discriminate between vehicles. This would minimize false positive detections.

Data collected	Metrics	Use
1. Equipment stoppages and resumptions	Time stamps of equipment stoppages and resumptions per day. (required)	TxDOT use to evaluate overall performance of the system.
2. Construction vehicle entry/exit gate system triggers	Total number of times warning devices were activated per week. (required)	TxDOT use to track the frequency of material handling truck activity.  Researchers' use to correlate material handling truck activity with crash statistics.
	Total number of reported crashes that occurred involving construction equipment vehicles. (required)	TxDOT use to assess work zone crash risks.

**Table 6: Temporary Construction Equipment System Performance Measures**

## 4.4 Temporary Travel Time System

### Design Requirements

The following requirements need to be addressed in the design documentation and specifications:

- A basic system should include at least 2 sensors at either end of the segment if using Bluetooth, 2 PCMS and an operating system
- Sensor locations to ensure comprehensive coverage of the work zone and the approach
- Automated continuous data acquisition if performance measures are needed or TMC desires situational awareness
- Battery recharge rates on solar powered systems.
- Real time data transfer connectivity to various agencies or a TMC
- Format and frequency requirements for archive data transmission to a TMC
- System operation hours - typically 24/7
- Error detection-correction mechanisms
- Travel Time/Delay sampling rates

The destination message to be displayed on the Portable Changeable Message Sign is specific to each Smart Work Zone. The message should be identified by the designer and included in the plans for the Contractor’s knowledge. Options for destinations to be displayed are:

- City Limits
- Crossing roadway

### Optional Functions

Project specific circumstances may warrant some optional features for Travel Time Systems. These can include the following.

Regional Travel Time Extensions can be used to encourage motorists 10 – 50 miles upstream that a regional alternate route is available. The detection would be the same, but the messages and the delivery systems would be designed to accommodate traveler information at these diversion points.

Probe Vehicle Travel Time Data can be utilized by the agency as an alternative or supplement to physical speed detectors. This provides a low cost means for assessing overall speed at a frequency of 5 to 15 minute intervals. This may be enough to support enforcement scheduling, identify incidents, and assess overall work zone performance. This can also be an effective means for assessing comparative speed assessments across the work zone vs. alternate routes so that motorists are presented with their best option at the local diversion points. If a regional Travel Time System is used, the Probe Vehicle Travel Time data can also be used to calculate travel times from the diversion point to the beginning of the work zone. This parameter can then be used to determine when the distant alternate advisories should be initiated and lifted.

Data collected	Metrics	Use
1. Equipment stoppages and resumptions	Time stamps of equipment stoppages and resumptions per day. (required)	TxDOT use to evaluate overall performance of the system.
2. Speed sampling at multiple points along the work zone (including the queue area)	Travel and Delay times estimate bin histograms per hour of each day. (required)	Motorists use to make informed decisions about alternate routes, arrival expectancies and congestion ahead.
3. Bluetooth MAC address/ timestamp sampling at various points along the work zone (including the queue area)		TxDOT use to assess impact of work zone configurations to possibly make changes to construction traffic patterns  TMC use to produce alternate route advisories.
4. Crowd sourced GPS subscription segment speed data	Standard deviation of travel time estimates per month. (required)	TxDOT use to assess impact of work zone configurations to possibly make changes to construction traffic patterns.  TMC use to produce alternate route advisories.

**Table 7: Temporary Travel Time System Performance Measures**

## 4.5 Temporary Incident Detection and Surveillance System

### Design Requirements

The following requirements need to be addressed in the design documentation and specifications:

- A basic system should include at least 1 sensor every mile, at least 1 video imaging system, and a Data streaming System
- CCTV camera locations to ensure comprehensive coverage of the work zone and the approaches. This will typically be areas of high risk such as the approach to a taper or crossover. This can include any areas where the designer anticipates motorist taking evasive or aggressive action
- Automated continuous data acquisition if performance measures are needed or TMCs need situational awareness is desired
- Battery recharge rates on solar powered systems
- Real time data transfer connectivity to various agencies or a TMC
- Format and frequency requirements for archive data transmission to a TMC
- System operation hours - typically 24/7
- Error detection-correction mechanisms
- Video image delivery rates

### Optional Functions

Project specific circumstances may warrant some optional features for Incident Detection and Surveillance Systems. These can include the following:

- Mobile CCTV cameras mounted on emergency or motorist assistance vehicles can provide on-site images where large incidents are occurring. They should be equipped with live data feeds to a TMC to be effective.
- Wrong Way Detection devices may be warranted for unusual intersections where motorist have been known to travel in the opposite direction of traffic by mistake. Sometimes the construction environment can be confusing to motorists who have sight limitations, are impaired or distracted, or during the night time hours.
- 360 degree radar combined with CCTV images can be useful for enforcement to maintain speed and headway compliance. These systems tag individual vehicles on the images with speed violation values so downstream enforcement personnel can isolate those aggressive drivers as they exit the work zone. This rather costly system would be justified in high volume, high speed work zone applications.

Data collected	Metrics	Use
1. Equipment stoppages and resumptions	Time stamps of equipment stoppages and resumptions per day. (required)	TxDOT use to evaluate overall performance of the system.

**Table 8: Temporary Incident Detection and Surveillance System Performance Measures**

## 4.6 Temporary Over-Height Vehicle Warning System

### Design Requirements

The following requirements need to be addressed in the design documentation and specifications:

- A basic system should include at least 1 sensor and 1 warning device before an exit ramp, at least 1 sensor and 1 warning device before the low clearance structure, and an operating system.
- Sensor locations and coverage areas to ensure capturing over-height vehicles.
- Incident archiving is useful for assessing the need to raise the structure or apply some other sort of re-engineering strategy.
- Battery recharge rates on solar powered systems if they are portable.
- Real time data transfer connectivity to various agencies or a TMC.
- Format and frequency requirements for archive data transmission to a TMC.
- System operation hours - typically 24/7.
- Error detection-correction mechanisms.
- Clearly define if there is concurrent deployment of systems during the project.
- Identify any needed relocation of the system during project phases.
- Ensure standard static clearance warning signing is in place, property located, and in good condition.

### PCMS Operations

PCMS should be dedicated exclusively to the over-height vehicle warning system and not display other messages. It is recommended to display the height of the hazard when system is not activated. A sample message can be LOW/BRIDGE/12'-0".

### Optional Functions

Project specific circumstances may warrant some optional features for Over-Height Warning Systems. This can include the following:

Traffic Management Center Integration can be used by linking the detection devices to the TMC to alert them when the system is triggered.

Data collected	Metrics	Use
1. Equipment stoppages and resumptions	Time stamps of equipment stoppages and resumptions per day. (required)	TxDOT use to evaluate overall performance of the system.
2. Frequency of Over-Height vehicle.	Total number of Over-Height alerts triggered per month.	TxDOT use to assess Over-Height vehicle frequency.
3. Number of Over-Height vehicle/cargo hitting low clearance structures.	Total number of times the structure was struck by Over-Height vehicles or cargo per week.	TxDOT use to evaluation effectiveness of the system.

**Table 9: Temporary Over-Height Vehicle Warning System Performance Measures**



## 4.7 Procurement

Smart Work Zone Systems shall be procured as contract bid items. TxDOT has developed the bid item specifications for work zone ITS systems, which may be found on the Department's website.

SWZ systems are typically included in conventional road/bridge contracts as traffic management line items. An alternative approach is to let an independent Smart Work Zone Contract that produces SWZs that cover a series of roadwork projects. This alternate contracting mechanism would enable "bridging" of SWZs across multiple contracts in terms of roadwork locations and construction time frames. Independent SWZ contracts have been successfully implemented in the State of Iowa. "Iowa DOT's statewide approach to intelligent work zones is unique. Many states deploy various types of intelligent work zone technologies on a project-by-project basis, but their systems may not be compatible across projects and their traffic management centers may not be able to monitor them. In our case, the Traffic Management Center receives alerts when queues are detected and uses the cameras and dynamic message signs just like our permanent cameras and signs. And they are also able to let us know whenever equipment or a work zone may need attention. This approach makes it easier to integrate, operate and update the SWZs as conditions change and also produces more consistent, reliable systems with a single point of contact for TxDOT TMC operations".

## 4.8 Typical costs

Typical SWZ costs can be expected to range between 1% and 5% of total project cost. The cost can vary significantly due to project specific characteristics and needs.

Some sample cost information from various DOTs and vendors are given below:

State of Illinois District 8 presentation "ITS Smart Work Zones" shows that based on six projects during 2014/2015 construction season, the average cost of SWZ deployment is about 3% of total project cost.

*Source: State of Illinois District 8 presentation "ITS Smart Work Zones" at THE Conference 2015*

In the case study "Massachusetts Department of Transportation Technology Applications on the Callahan Tunnel Project", construction Dec 2013 to Mar 2014, MassDOT procured equipment as a lump sum bid item and it accounted for 5% of total project cost. Project duration was about 4 months and deployment occurred during winter requiring maintenance.

*Source: Case study: Massachusetts Department of Transportation Technology Applications on the Callahan Tunnel Project.*

More cost examples are presented in Appendix C.

THIS PAGE HAS INTENTIONALLY BEEN LEFT BLANK

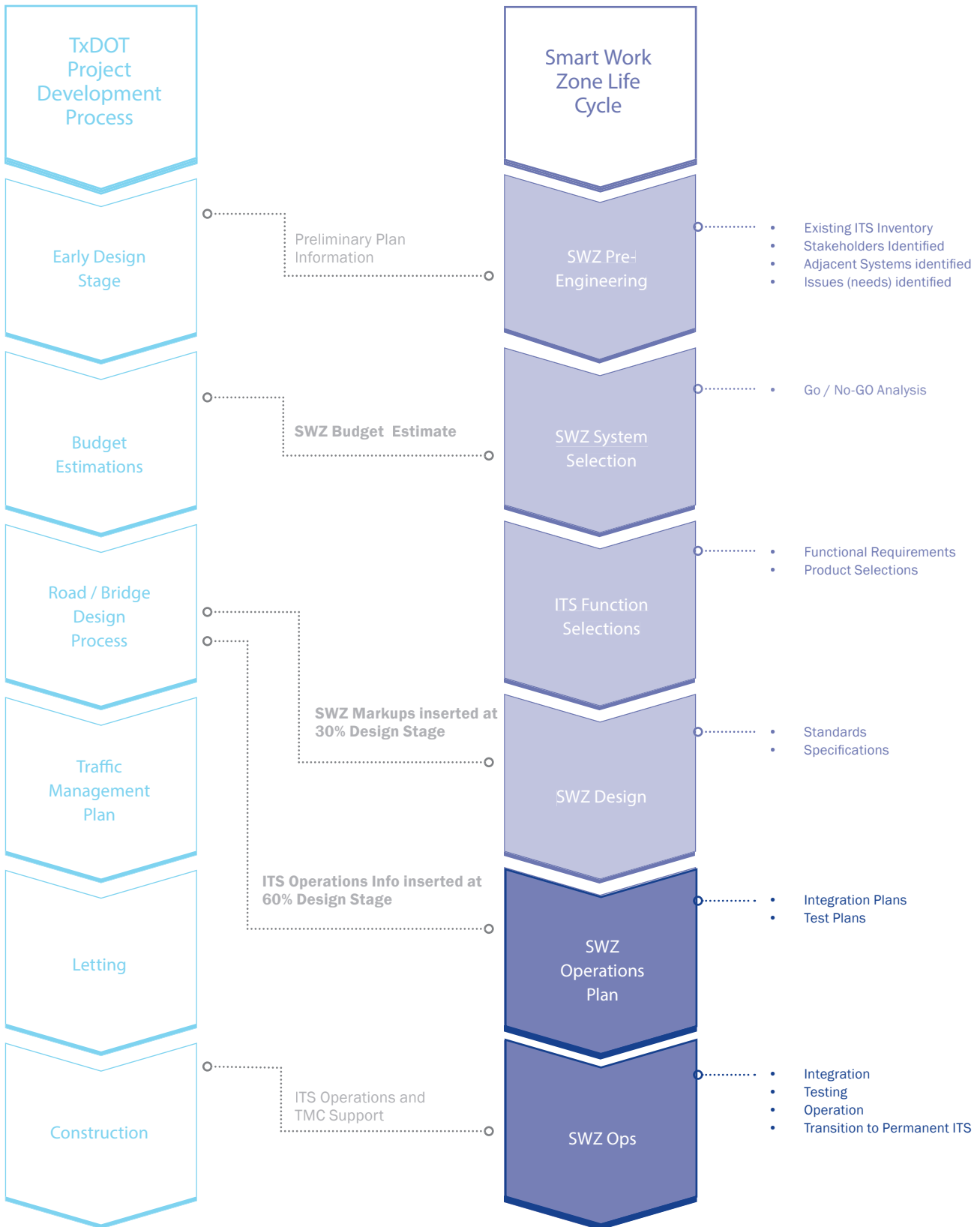

---

## 5. Smart Work Zone Deployment

---

### 5.1 Operations and Maintenance

The Contractor shall be responsible for the setup, calibration and maintenance of the ITS equipment through the life of the project. Initial dates for activating the system should be specified in the design documents along with consequences for failure to meet the schedule. Adhering to the schedule for operating a system is important because the first few days of a new work zone or a major change in traffic patterns typically cause motorists some confusion as they navigate through unfamiliar traffic patterns.

The “Standard Specifications for Construction and Maintenance of Highways, Streets, and Bridges”, adopted November 2014 also addresses operations.

Section 2.6 of the above mentioned Standard Specifications addresses how to deal with discrepancies between the TMUTCD, the Compliant Work Zone Traffic Control Device List (CWZTCDL) and the Plan. It also addresses how unexpected changes should be handled.

Section 2.6.1 in the TMUTCD mandates that the Contractor provide a “...Contractor’s Responsible Person (CRP) and an alternate to be the representative of the Contractor who is responsible for taking or directing corrective measures regarding the traffic control.” This section also addresses how this person must be accessible and responsive 24 hour per day.

This topic of Operations and Maintenance also includes the production and delivery of data and performance reports to the various agencies as specified in the contract. The content, format, and quality of data production shall also be specified in the contract documents. Again, consequences for failure to deliver within appropriate time frames need to be included in the specifications.

### Security

The Contractor shall be responsible to meet minimum security requirements for the equipment and the data as specified in the contract documents. This shall include protected procedures for agency personnel to access the data as needed, or to override a malfunctioning system to terminate traveler information that is discovered to be in error. This can include periodic performance reports and direct feeds to TMC dashboards as required.

### 5.2 SWZ Data

Intelligent Transportation Systems produce and act upon information which is derived from various sources of data. Examples include vehicle speeds, counts, classifications and detection time stamps. CCTV images are another form of data that becomes useful for various applications such as confirming incidents, identifying roadway damage or cargo spills. Effective use of this information can significantly reduce delay, improve safety and reduce air pollution.

### 5.3 Evaluation

The Contractor shall be responsible for all maintenance of the SWZ system during the entire project as specified in the contract documents. This includes repair, replacement, calibration, recalibration, and relocation as needed. Consequences for failure to deliver or maintain this equipment should be clearly stated in the contract documents to ensure a reliable SWZ system.

### 5.4 Decommission/Removal

The Contractor is responsible for the removal of all SWZ systems as specified in the contract documents. This will typically occur at the point in the project when it is no longer needed and often occurs prior to acceptance. In some cases the equipment may be required to be left operational to gather additional post-project data for research purposes.

THIS PAGE HAS INTENTIONALLY BEEN LEFT BLANK

# References

1. Work Zone Intelligent Transportation Systems Implementation Guide. FHWA-HOP-014-008. Washington D.C.: Federal Highway Administration. January 2014.
2. Federal Highways Administration, U.S. Department of Transportation. Manual on Uniform Traffic Control Devices. 2009 Edition with Revisions 1 and 2, May 2012.
3. Texas Manual on Uniform Traffic Control Devices, 2011 Version, Revision 2, TxDOT, 2014
4. Federal Highways Administration, U.S. Department of Transportation. Portable Changeable Message Sign Handbook. FHWA-RD-03-066. 2003.
5. New Hampshire Work Zone ITS Toolbox, Work Zone ITS Guideline for Smart Work Zone System Selection, 2011 Edition. [https://www.nh.gov/dot/org/projectdevelopment/highwaydesign/documents/swzman\\_05102011.pdf](https://www.nh.gov/dot/org/projectdevelopment/highwaydesign/documents/swzman_05102011.pdf)
6. Iowa DOT, Traffic Critical Projects Program 2015 Final Report. [http://www.itsheartland.org/events/2016/2016HeartlandPresentations/Session1\\_Kramer.pdf](http://www.itsheartland.org/events/2016/2016HeartlandPresentations/Session1_Kramer.pdf)
7. CTDOT Smart Work Zone Guideline 2017, [http://www.ct.gov/dot/lib/dot/documents/dconstruction/wzs\\_reviews/str\\_swz\\_guide\\_final\\_2017-04-06\\_with\\_cover.pdf](http://www.ct.gov/dot/lib/dot/documents/dconstruction/wzs_reviews/str_swz_guide_final_2017-04-06_with_cover.pdf)
8. State of Illinois District 8 presentation “ITS Smart Work Zones” at THE Conference 2015. <http://www.theconf.com/presentations/2015/Experiences%20with%20Smart%20Work%20Zones%20in%20Southern%20Illinois.pdf>
9. Case study: Massachusetts Department of Transportation Technology Applications on the Callahan Tunnel Project. 2014. [https://www.workzonesafety.org/files/documents/SWZ/MA\\_TA\\_case\\_study.pdf](https://www.workzonesafety.org/files/documents/SWZ/MA_TA_case_study.pdf)
10. Portable Work Zone Management Systems (ITS in Work Zones) Technology Review and Workshop Presentation: Background Material, IBI Group Memorandum dated August 22, 2016.
11. TxDOT Traffic Engineering Standard Sheet. <http://www.dot.state.tx.us/insdtdot/orgchart/cmd/cserve/standard/toc.htm>
12. Iowa Statewide Smart Work Zone <http://www.transportationmatters.iowadot.gov/2017/04/new-technologies-make-iowa-work-zones-safer.html>

# Appendices

- A. SWZ Selection Go-No-Go Decision Tool
- B. Maximum Queue Length Estimator
- C. SWZ System Cost Examples



## Appendix A. SWZ System Go/No-Go Decision Tool

### Smart Work Zone

This Workbook is a Decision Tree for Smart Work Zone system selection.

TxDOT currently promotes the use of six SWZ systems that are addressed individually in the next six workbook tabs.

These Go/NoGo Decision trees produce planning level scores for each of those six SWZ systems. That score can be helpful for prioritizing and budgeting purposes.

#### Instructions :

##### For Go/NoGo Decision Tree

- 1- Insert the appropriate values for each criteria in the "Score" column.
- 2- On "Estimate Queue Length" use the "Max Queue Length" tab if a rigorous calculation is not available.
- 3- Once the scores are completed, the "Normalized Total" can be used to decide the Systems to use.
- 4- When the system selection is completed move on to the "System Cost Samples" to estimate if the projects can be funded.
- 5- All of the six systems scores are summarized in the "4 - Summary" tab.

##### For System Cost Examples

- 1- Examples of past projects costs are listed here.
- 2- Each system has a different example.
- 3- Select the Project Description that best fits the characteristics of the scored project.

<b>Smart Work Zone</b> <b>Go/No-Go Decision Tree - A criteria based tool for selecting Smart Work Zone Systems</b> <b>Temporary Queue Detection System</b>		
Project Number:		
County:		
CSJ:		
Letting:		
Date Form Completed:		
Completed by:		
Scoring Factors	Scoring Range	Score
<b>Impact from local traffic generators</b>	Significant-local facilities are large enough to have official destination signs on the Interstate highway such as conference centers, sports arenas etc., so they produce large surges in traffic before/after large events <b>(20 points)</b> Moderate-Local businesses or public facilities generate traffic volumes that routinely backup the on/off ramps such as morning and evening rush hours <b>(10 points)</b> Minimal-Any circumstance that causes occasional backups on the on/off ramps such as congested local arterials or rail crossings <b>(5 points)</b> None <b>(0 points)</b>	
<b>Estimated Queue Length (Calculated, or see Max Queue Length tab for rough estimate)</b>	> 7 miles <b>(130 points)</b> 3.5 to 7 miles <b>(110 points)</b> 0 to 3.5 miles <b>(85 points)</b> None <b>(0 points)</b>	
<b>Sight Distance at back of Queue</b>	Sight distance issues exist where the back of queue will likely occur. <b>(30 points)</b>	
<b>Existing traffic issues</b>	Higher than normal crash rates, gridlock or frequent exit ramp backups <b>(30 points)</b> Not applicable <b>(0 points)</b>	
<b>Availability of Alternate routes</b>	Convenient alternate routes with capacity are available. <b>(3 points)</b> No alternate routes available <b>(0 points)</b>	
<b>Merging conflict or hazards on the approach to work zone</b>	External merging conflicts or hazards on the approach to or within the work zone. <b>(15 points)</b> Not applicable <b>(0 points)</b>	
<b>Complex traffic control layout</b>	Multiple crossovers, sharp curves or lane splits <b>(3 points)</b> Not applicable <b>(0 points)</b>	
<b>Adjacent/consecutive project</b>	There are adjacent active projects effectively creating a mega-project that totals... longer than 10 miles or longer than 2 years <b>(3 points)</b> between 5 to 10 miles or between 1 and 2 years <b>(2 points)</b> between 2 to 5 miles or between 6 months to 1 year <b>(1 point)</b> less than 2 miles or less than 6 months <b>(0 points)</b>	
<b>Scattered/short term project</b>	The project includes multiple short term lane restricting activities that are scattered across the state. (ex. bridge painting) <b>(3 points)</b> Not applicable <b>(0 points)</b>	
<b>Extreme weather condition</b>	Work zone has a known history of sudden extreme weather condition, sandstorm, etc. Or project duration covers several harsh weather season. <b>(3 points)</b> Not applicable <b>(0 points)</b>	
<b>Connected vehicle</b>	>5% <b>(3 points)</b> <5% <b>(0 points)</b>	
<b>Existing ITS Systems</b>	Project falls inside an existing Advanced Traffic Management System? The TMC has the intent to incorporate the travel time and delay estimating system into the TMC operations? The TMC can remotely control their existing advance traveler information systems? <b>(Each question worth 1 point)</b>	
<b>Heavy vehicles</b>	>12% <b>(3 points)</b> >9% <b>(2 points)</b> >6% <b>(1 point)</b> <=6% <b>(0 points)</b>	
<b>Raw Scores</b>		<b>0</b>
<b>Max Possible score</b>		<b>249</b>
<b>Normalized Scores (0 to 100)*</b>		<b>0</b>

\* Normalized Score is calculated by Raw Scores\*100/Max Possible Score

<b>Smart Work Zone</b>																														
<b>Go/No-Go Decision Tree - A criteria based tool for selecting Smart Work Zone Systems</b>																														
<b>Temporary Speed Monitoring System</b>																														
<b>Project Number:</b>																														
<b>County:</b>																														
<b>CSJ:</b>																														
<b>Letting:</b>																														
<b>Date Form Completed:</b>																														
<b>Completed by:</b>																														
Scoring Factors	Scoring Range																													
<b>Duration of the Work Zone</b>	For projects with multiple work zones (ex. bridge painting or patching), score the duration of the longest work zone only. > 1 year (10 points) 1 - 10 months (5 points) < 1 months (0 points)																													
<b>Highway Function Class and ADT</b>	<table border="1" style="margin-left: auto; margin-right: auto;"> <thead> <tr> <th rowspan="2">Functional Class</th> <th colspan="4">ADT</th> </tr> <tr> <th>200,000+</th> <th>100,000+</th> <th>50,000+</th> <th>20,000+</th> </tr> </thead> <tbody> <tr> <td>Interstate</td> <td>50</td> <td>50</td> <td>50</td> <td>30</td> </tr> <tr> <td>Freeway/expressway</td> <td>50</td> <td>50</td> <td>30</td> <td>30</td> </tr> <tr> <td>Major Aterial</td> <td></td> <td>30</td> <td>30</td> <td>10</td> </tr> <tr> <td>Other</td> <td></td> <td></td> <td>10</td> <td>10</td> </tr> </tbody> </table>	Functional Class	ADT				200,000+	100,000+	50,000+	20,000+	Interstate	50	50	50	30	Freeway/expressway	50	50	30	30	Major Aterial		30	30	10	Other			10	10
Functional Class	ADT																													
	200,000+	100,000+	50,000+	20,000+																										
Interstate	50	50	50	30																										
Freeway/expressway	50	50	30	30																										
Major Aterial		30	30	10																										
Other			10	10																										
<b>Impact from local traffic generators</b>	Significant-local facilities are large enough to have official destination signs on the Interstate highway such as conference centers, sports arenas etc., so they produce large surges in traffic before/after large events (10 points) Moderate-Local businesses or public facilities generate traffic volumes that routinely backup the on/off ramps such as morning and evening rush hours (6 points) Minimal-Any circumstance that causes occasional backups on the on/off ramps such as congested local arterials or rail crossings (3 points) None (0 points)																													
<b>Estimated Queue Length (Calculated, or see Max Queue Length tab for rough estimate)</b>	> 7 miles (10 points) 3.5 to 7 miles (7 points) 0 to 3.5 miles(3 points) None (0 points)																													
<b>Sight Distance at back of Queue</b>	Sight distance issues exist where the back of queue will likely occur. (3 points) Not applicable (0 points)																													
<b>Existing traffic issues</b>	Higher than normal crash rates gridlock or frequent exit ramp backups (30 points) Not applicable (0 points)																													
<b>Merging conflict or hazards on the approach to work zone</b>	External merging conflicts or hazards on the approach to or within the work zone. (3 points)																													
<b>Complex traffic control layout</b>	Multiple crossovers, sharp curves or lane splits (3 points) Not applicable (0 points)																													
<b>Chronic speeding issues</b>	Work zones in the area have a history of chronic speeders >20 mph over speed limit. (50 points) Not applicable (0 points)																													
<b>Large speed variations</b>	Work zone area has a history of unusually high average traffic speed variability. This is common on Interstate by-pass and outer rings. (50 points) Not applicable (0 points)																													
<b>Adjacent/consecutive project</b>	There are adjacent active projects effectively creating a mega-project that totals... longer than 10 miles or longer than 2 years (3 points) between 5 to 10 miles or between 1 and 2 years (2 points) between 2 to 5 miles or between 6 months to 1 year (1 point) less than 2 miles or less than 6 months (0 points)																													
<b>Scattered/short term project</b>	The project includes multiple short term lane restricting activities that are scattered across the state. (ex. bridge painting) (3 points) Not applicable (0 points)																													
<b>Heavy vehicles</b>	>12% (3 points) >9%(2 points) >6% (1 point) <6% (0 points)																													
<b>Construction vehicle entering</b>	Construction vehicles (material handling trucks) will enter/exit the main lanes traffic stream (3 points) Vehicles will be entering/exiting from outside the work zone (0 points)																													
<b>Raw Scores</b>		<b>0</b>																												
<b>Max Possible score</b>		<b>231</b>																												
<b>Normalized Scores (0 to 100)</b>		<b>0</b>																												
* Normalized Score is calculated by Raw Scores*100/Max Possible Score																														

<b>Smart Work Zone</b>																															
<b>Go/No-Go Decision Tree - A criteria based tool for selecting Smart Work Zone Systems</b>																															
<b>Temporary Construction Equipment Alert System</b>																															
Project Number:																															
County:																															
CSJ:																															
Letting:																															
Date Form Completed:																															
Completed by:																															
Scoring Factors	Scoring Range	Score																													
<b>Duration of the Work Zone</b>	For projects with multiple work zones (ex. bridge painting or patching), score the duration of the longest work zone only. > 1 year <b>(10 points)</b> 1 - 10 months <b>(5 points)</b> < 1 months <b>(0 points)</b>																														
<b>Highway Function Class and ADT</b>	<table border="1" style="margin-left: auto; margin-right: auto; border-collapse: collapse;"> <thead> <tr> <th rowspan="2">Functional Class</th> <th colspan="4">ADT</th> </tr> <tr> <th>200,000+</th> <th>100,000+</th> <th>50,000+</th> <th>20,000+</th> </tr> </thead> <tbody> <tr> <td>Interstate</td> <td style="background-color: #f08080;">20</td> <td style="background-color: #f08080;">20</td> <td style="background-color: #f08080;">20</td> <td style="background-color: #f08080;">10</td> </tr> <tr> <td>Freeway/expressway</td> <td style="background-color: #ffff00;">20</td> <td style="background-color: #ffff00;">20</td> <td style="background-color: #ffff00;">10</td> <td style="background-color: #ffff00;">10</td> </tr> <tr> <td>Major Aterial</td> <td></td> <td style="background-color: #ffff00;">10</td> <td style="background-color: #ffff00;">10</td> <td style="background-color: #00ff00;">5</td> </tr> <tr> <td>Other</td> <td></td> <td></td> <td style="background-color: #00ff00;">5</td> <td style="background-color: #00ff00;">5</td> </tr> </tbody> </table>	Functional Class	ADT				200,000+	100,000+	50,000+	20,000+	Interstate	20	20	20	10	Freeway/expressway	20	20	10	10	Major Aterial		10	10	5	Other			5	5	
Functional Class	ADT																														
	200,000+	100,000+	50,000+	20,000+																											
Interstate	20	20	20	10																											
Freeway/expressway	20	20	10	10																											
Major Aterial		10	10	5																											
Other			5	5																											
<b>Existing traffic issues</b>	Higher than normal crash rates, gridlock or frequent exit ramp backups <b>(30 points)</b> Not applicable <b>(0 points)</b>																														
<b>Complex traffic control layout</b>	Multiple crossovers, sharp curves or lane splits <b>(3 points)</b>																														
<b>Chronic speeding issues</b>	Work zones in the area have a history of chronic speeders >20 mph over speed limit. <b>(3 points)</b>																														
<b>Large speed variations</b>	Work zone area has a history of unusually high average traffic speed variability. This is common on Interstate by-pass and outer rings. <b>(3 points)</b> Not applicable <b>(0 points)</b>																														
<b>Connected vehicle</b>	>5% <b>(3 points)</b> <5% <b>(0 points)</b>																														
<b>Heavy vehicles</b>	>12% <b>(3 points)</b> >9% <b>(2 points)</b> >6% <b>(1 point)</b> <6% <b>(0 points)</b>																														
<b>Construction vehicle entering</b>	Construction vehicles (material handling trucks) will enter/exit the main lanes traffic stream <b>(120 points)</b> vehicles will be entering/exiting from outside the work zone <b>(0 points)</b>																														
<b>Raw Scores</b>		<b>0</b>																													
<b>Max Possible score</b>		<b>195</b>																													
<b>Normalized Scores (0 to 100)</b>		<b>0</b>																													
* Normalized Score is calculated by Raw Scores*100/Max Possible Score																															

<b>Smart Work Zone</b> <b>Go/No-Go Decision Tree - A criteria based tool for selecting Smart Work Zone Systems</b> <b>Temporary Travel Time System</b>																															
Project Number:																															
County:																															
CSJ:																															
Letting:																															
Date Form Completed:																															
Completed by:																															
Scoring Factors	Scoring Range	Score																													
Duration of the Work Zone	For projects with multiple work zones (ex. bridge painting or patching), score the duration of the longest work zone only. > 1 year <b>(10 points)</b> 1 - 10 months <b>(5 points)</b> < 1 months <b>(0 points)</b>																														
Highway Function Class and ADT	<table border="1"> <thead> <tr> <th rowspan="2">Functional Class</th> <th colspan="4">ADT</th> </tr> <tr> <th>200,000+</th> <th>100,000+</th> <th>50,000+</th> <th>20,000+</th> </tr> </thead> <tbody> <tr> <td>Interstate</td> <td>50</td> <td>50</td> <td>50</td> <td>30</td> </tr> <tr> <td>Freeway/expressway</td> <td>50</td> <td>50</td> <td>30</td> <td>30</td> </tr> <tr> <td>Major Aterial</td> <td></td> <td>30</td> <td>30</td> <td>10</td> </tr> <tr> <td>Other</td> <td></td> <td></td> <td>10</td> <td>10</td> </tr> </tbody> </table>	Functional Class	ADT				200,000+	100,000+	50,000+	20,000+	Interstate	50	50	50	30	Freeway/expressway	50	50	30	30	Major Aterial		30	30	10	Other			10	10	
Functional Class	ADT																														
	200,000+	100,000+	50,000+	20,000+																											
Interstate	50	50	50	30																											
Freeway/expressway	50	50	30	30																											
Major Aterial		30	30	10																											
Other			10	10																											
Impact from local traffic generators	Significant-local facilities are large enough to have official destination signs on the Interstate highway such as conference centers, sports arenas etc., so they produce large surges in traffic before/after large events <b>(20 points)</b> Moderate-Local businesses or public facilities generate traffic volumes that routinely backup the on/off ramps such as morning and evening rush hours <b>(10 points)</b> Minimal-Any circumstance that causes occasional backups on the on/off ramps such as congested local arterials or rail crossings <b>(5 points)</b> None <b>(0 points)</b>																														
Estimated Queue Length (Calculated, or see Max Queue Length tab for rough estimate)	> 7 miles <b>(80 points)</b> 3.5 to 7 miles <b>(70 points)</b> 0 to 3.5 miles <b>(60 points)</b> None <b>(0 points)</b>																														
Existing traffic issues	higher than normal crash rates, gridlock or frequent exit ramp backups <b>(3 points)</b> Not applicable <b>(0 points)</b>																														
Availability of Alternate routes	Convenient alternate routes with capacity are available. <b>(3 points)</b>																														
Adjacent/consecutive project	There are adjacent active projects effectively creating a mega-project that totals... longer than 10 miles or longer than 2 years <b>(3 points)</b> between 5 to 10 miles or between 1 and 2 years <b>(2 points)</b> between 2 to 5 miles or between 6 months to 1 year <b>(1 point)</b> less than 2 miles or less than 6 months <b>(0 points)</b>																														
Extreme weather condition	Work zone has a known history of sudden extreme weather condition, sandstorm, etc. Project duration covers several harsh weather season. <b>(3 points)</b>																														
Connected vehicle	>5% <b>(3 points)</b> <5% <b>(0 points)</b>																														
Existing ITS Systems	Project falls inside an existing Advanced Traffic Management System? The TMC has the intent to incorporate the travel time and delay estimating system into the TMC operations? The TMC can remotely control their existing advance traveler information systems? <b>(Each question worth 10 point)</b>																														
Heavy vehicles	>12% <b>(3 points)</b> >9% <b>(2 points)</b> >6% <b>(1 point)</b> <6% <b>(0 points)</b>																														
<b>Raw Scores</b>		<b>0</b>																													
<b>Max Possible score</b>		<b>208</b>																													
<b>Normalized Scores (0 to 100)</b>		<b>0</b>																													

\* Normalized Score is calculated by Raw Scores\*100/Max Possible Score

<p align="center"><b>Smart Work Zone</b></p> <p align="center"><b>Go/No-Go Decision Tree - A criteria based tool for selecting Smart Work Zone Systems</b></p> <p align="center"><b>Temporary Incident Detection &amp; Surveillance System</b></p>																															
Project Number:																															
County:																															
CSJ:																															
Letting:																															
Date Form Completed:																															
Completed by:																															
Scoring Factors	Scoring Range	Score																													
Duration of the Work Zone	For projects with multiple work zones (ex. bridge painting or patching), score the duration of the longest work zone only. > 1 year <b>(10 points)</b> 1 - 10 months <b>(5 points)</b> < 1 months <b>(0 points)</b>																														
Highway Function Class and ADT	<table border="1"> <thead> <tr> <th rowspan="2">Functional Class</th> <th colspan="4">ADT</th> </tr> <tr> <th>200,000+</th> <th>100,000+</th> <th>50,000+</th> <th>20,000+</th> </tr> </thead> <tbody> <tr> <td>Interstate</td> <td>80</td> <td>80</td> <td>80</td> <td>50</td> </tr> <tr> <td>Freeway/expressway</td> <td>80</td> <td>80</td> <td>50</td> <td>50</td> </tr> <tr> <td>Major Arterial</td> <td></td> <td>50</td> <td>50</td> <td>20</td> </tr> <tr> <td>Other</td> <td></td> <td></td> <td>20</td> <td>20</td> </tr> </tbody> </table>	Functional Class	ADT				200,000+	100,000+	50,000+	20,000+	Interstate	80	80	80	50	Freeway/expressway	80	80	50	50	Major Arterial		50	50	20	Other			20	20	
Functional Class	ADT																														
	200,000+	100,000+	50,000+	20,000+																											
Interstate	80	80	80	50																											
Freeway/expressway	80	80	50	50																											
Major Arterial		50	50	20																											
Other			20	20																											
Impact from local traffic generators	Significant-local facilities are large enough to have official destination signs on the Interstate highway such as conference centers, sports arenas etc., so they produce large surges in traffic before/after large events <b>(10 points)</b> Moderate-Local businesses or public facilities generate traffic volumes that routinely backup the on/off ramps such as morning and evening rush hours <b>(6 points)</b> Minimal-Any circumstance that causes occasional backups on the on/off ramps such as congested local arterials or rail crossings <b>(3 points)</b> None <b>(0 points)</b>																														
Sight Distance at back of Queue	Sight distance issues exist where the back of queue will likely occur. <b>(50 points)</b>																														
Existing traffic issues	higher than normal crash rates, gridlock or frequent exit ramp backups <b>(50 points)</b> Not applicable <b>(0 points)</b>																														
Merging conflict or hazards on the approach to work zone	External merging conflicts or hazards on the approach to or within the work zone. <b>(3 points)</b> Not applicable <b>(0 points)</b>																														
Complex traffic control layout	multiple crossovers, sharp curves or lane splits <b>(3 points)</b> Not applicable <b>(0 points)</b>																														
Navigating constraints for emergency responders	Construction activity will impose significant constraints for emergency responders to access incidents. (ex. narrow lanes or no shoulders) <b>(50 points)</b> Not applicable <b>(0 points)</b>																														
Chronic speeding issues	Work zones in the area have a history of chronic speeders >20 mph over speed limit. <b>(3 points)</b> Not applicable <b>(0 points)</b>																														
Large speed variations	Work zone area has a history of unusually high average traffic speed variability. This is common on Interstate by-pass and outer rings. <b>(50 points)</b> Not applicable <b>(0 points)</b>																														
Adjacent/consecutive project	There are adjacent active projects effectively creating a mega-project that totals... longer than 10 miles or longer than 2 years <b>(3 points)</b> between 5 to 10 miles or between 1 and 2 years <b>(2 points)</b> between 2 to 5 miles or between 6 months to 1 year <b>(1 point)</b> less than 2 miles or less than 6 months <b>(0 points)</b>																														
Scattered/short term project	The project includes multiple short term lane restricting activities that are scattered across the state. (ex. bridge painting) <b>(3 points)</b> Not applicable <b>(0 points)</b>																														
Extreme weather condition	Work zone has a known history of sudden extreme weather condition, sandstorm, etc. Project duration covers several harsh weather season. <b>(3 points)</b> Not applicable <b>(0 points)</b>																														
Connected vehicle	>5% <b>(3 points)</b> <5% <b>(0 points)</b>																														
Heavy vehicles	>12% <b>(60 points)</b> >9% <b>(40 points)</b> >6% <b>(20 point)</b> <6% <b>(0 points)</b>																														
<b>Raw Scores</b>		<b>0</b>																													
<b>Max Possible score</b>		<b>381</b>																													
<b>Normalized Scores (0 to 100)</b>		<b>0</b>																													

\*Normalized Score is calculated by Raw Scores\*100/Max Possible Score

<b>Smart Work Zone</b> <b>Go/No-Go Decision Tree - A criteria based tool for selecting Smart Work Zone Systems</b> <b>Temporary Over-height Vehicle Warning System</b>		
Project Number:		
County:		
CSJ:		
Letting:		
Date Form Completed:		
Completed by:		
Scoring Factors	Scoring Range	Score
<b>Over-height vehicle/Low Clearance Structure</b>	Low structures are over mainline traffic <b>(100 points)</b>	
	Low structures are located on adjoining roadways such as ramps <b>(75 points)</b>	
	Low structures are located on nearby alternate routes (local or state owned) <b>(45 points)</b>	
	There are no low structures <b>(0 points)</b>	
	<b>Raw Scores</b>	<b>0</b>
<b>Max Possible score</b>		100
<b>Normalized Scores (0 to 100)</b>		<b>0</b>
* Normalized Score is calculated by Raw Scores*100/Max Possible Score		

**Decisions:**

<b>Is strongly recommended if the score is greater than 65</b>
<b>Should be given consideration if score is between 33 and 65</b>
<b>Is probably not recommended if the score is below 33</b>

System	Total Score
Temporary Queue Detection System	
Temporary Speed Monitoring System	
Temporary Construction Equipment Alert System	
Temporary Travel Time System	
Temporary Incident Detection & Surveillance System	
Temporary Over-height Vehicle Warning System	



## Appendix B. Maximum Queue Length Estimator

Estimated Queue Factor Scoring (based on AADT)(24-hour lane closure)									
<i>AADT values are 2 directional counts. Queue length values represent one direction only.</i>									
Queue Length Categories >>>		Approx. maximum AADT values per queue length category							
# Lanes Pre-Work Zone	# Lanes during Work Zone	No significant queuing	AADT	Mild Queuing < 3.5 miles	AADT	Moderate Queuing 3.5 to 7.5 miles	AADT	Heavy Queuing > 7.5 miles	AADT
2	1	Score 0	40,000	Score 3	46,000	Score 7	52,000	Score 10	> 52,000
3	2		82,000		92,000		102,000		> 102,000
3	1		40,000		50,000		56,000		>56,000

Estimated Queue Factor Scoring (based on AADT)(9PM to 5AM lane closure)									
<i>AADT values are 2 directional counts. Queue length values represent one direction only.</i>									
Queue Length Categories >>>		Approx. maximum AADT values per queue length category							
# Lanes Pre-Work Zone	# Lanes during Work Zone	No significant queuing	AADT	Mild Queuing < 3.5 miles	AADT	Moderate Queuing 3.5 to 7.5 miles	AADT	Heavy Queuing > 7.5 miles	AADT
2	1	Score 0	52,000	Score 3	84,000	Score 7	108,000	Score 10	> 108,000
3	2		100,000		138,000		200,000		> 200,000
3	1		54,000		98,000		132,000		> 132,000

**How to use this Table:** Identify lane closure hours during a day (24 hour or 9PM to 5 AM) to determine which table to use.  
 Find an approximate 2 directional AADT for your Work Zone from TxDOT's Traffic Count Website or some other source.  
 On the table above, enter the row that describes your project's lane usage (one directional). (ex. 3 lanes to 2)  
 Proceed to the right on that row until you locate the first AADT value higher than your project's AADT  
 If your project's AADT is greater than the value in the last column to the right, use a score of 10  
 The Estimated Queue Factor score is then found in the yellow box immediately to the left of that AADT.  
 The queuing range for your project is in the cell immediately above the yellow box with the score.

**Limitations of this Table:** These two tables were developed based on a single case study and a single day traffic count.  
 The look-up tables are intended to only provide an approximate queue length.

### Appendix C. SWZ System Cost Examples

System Cost Example			
ITS System Go/No Go	Project Description		
<p>Temporary Queue Detection System</p> <p>System that continuously monitors traffic on the approaches and within construction work zones to detect slowed or stopped traffic. This information is then presented to approaching motorists so they can make informed decisions. [A Basic System should include at least 1 sensor every 1 mile, 1 PCMS every sensor, and a n Operating System]</p>	<p>110 days Letting Year: On 201 6 Cost Includes: 24/7 Maintenance Staff Wireless communication Equipment leased CS# 0015-15-380</p> <p>Installation/Removal/PCMS 4 Doppler Radar r</p> <p>Operational Central Software Solar Power Operate d</p> <p>\$586.20 each setup (0.39% of total construction cost)</p>	<p>192 days Letting Year: 201 7 Cost Includes: 24/7 Maintenance Staff Wireless communication Equipment leased CS# 0015-13-378</p> <p>Installation/Removal/PCMS 4 Doppler Radar r</p> <p>Operational Central Software Solar Power Operate d</p> <p>\$550 each setup (0.25% of total construction cost)</p>	
<p>Temporary Travel Time System</p> <p>System that continuously monitors travel times through a work zone, and then presents this information to approaching motorists so they can make informed decisions. [A Basic System should include at least 2 sensors at either end of the segment if using Bluetooth, 2 PCMS and an Operating System]</p>	<p>5 months Letting Year: On 201 7 Cost Includes: 24/7 Maintenance Staff Wireless communication 16 Sensors Equipment leased CS# 0015-13-380</p> <p>Installation/Removal/PCMS 2 Camera Trailer s</p> <p>Operational Solar Power Operate d Central Software e</p> <p>\$123,000 Source: Vendor Street Smart Rentals</p>	<p>34 month Letting Year: 201 5 Cost Includes: 24/7 Maintenance Staff 1/8 Lane Sidefire Radar 8 Trailers Wireless communication Equipment leased CS# 0015-13-379</p> <p>Installation/Removal/PCMS 8 CCTV camera s</p> <p>Operational Solar Power Operate d Central Software e</p> <p>\$835,600 (1% of total construction cost)</p>	
<p>Temporary Incident Detection and Surveillance System</p> <p>System that uses sensors and/or video to detect crashes and other incident conditions within a work zone and then communicates that information to a local TMC and/or to emergency response agencies. The alerts are then confirmed remotely using live streaming video, snapshots or on-site personnel. This System can be used to provide critical information to responders who help them decide exactly what equipment to bring, how best to approach the incident, and any additional precautions that might be needed to protect themselves and the public. [A Basic System should include at least 1 sensor every 1 mile, at least 1 Video Imaging System, and a Data Streaming System]</p>	<p>20 month Letting Year: 201 6 Cost Includes: 24/7 Maintenance Staff Wireless communication 3 CCTV camera 1 PCMS with modem Equipment leased CS# 0015-13-380</p> <p>Installation/Removal/Trailers 1 Doppler Radar 8 Lane Sidefire Radar r</p> <p>Operational Solar Power Operate d Central Software e 3 PCMS</p> <p>\$306,616.75 (2% of total construction cost)</p>	<p>76 month Letting Year: 201 7 Cost Includes: 24/7 Maintenance Staff Wireless communication 8 CCTV camera 5 PCMS Equipment leased CS# 0015-17-161</p> <p>Installation/Removal/Trailers 8 Lane Sidefire Radar 6 Doppler Radar Unit s</p> <p>Operational Solar Power Operate d Central Software e</p> <p>\$2,395,816 (1% of total construction cost)</p>	
<p>Temporary Construction Equipment Alert System</p> <p>System that delivers immediate information to motorists about construction vehicles and equipment that are entering the highway from a work zone. [A Basic System should include at least 1 sensor and at least 1 Warning Device]</p>	<p>16 Advance Warning Flasher Cellphone Communication Installation/Removal E-mail reporting Equipment leased</p> <p>Installation/Removal/PCMS 4 Doppler Radar r Software</p> <p>Removal 24/7 Maintenance Staff Post mounted d</p> <p>\$44,000 (0.37% of total construction cost)</p>	<p>145 month Cost Includes: Cellphone Communication License Plate Reader System Installation/Removal E-mail reporting Equipment lease</p> <p>Installation/Removal/PCMS 24/7 Maintenance Staff Trailer mounted Post/Trailer</p> <p>\$400,000 (0.05% of total construction cost)</p>	

**Washington State Department of Transportation**

WSDOT Design Manual Chapter 1010 Work Zone Safety and Mobility – July 2017

<http://www.wsdot.wa.gov/publications/manuals/fulltext/M22-01/1010.pdf>

WSDOT Design Manual Chapter 1050 Intelligent Transportation Systems – July 2014

<http://www.wsdot.wa.gov/publications/manuals/fulltext/M22-01/1050.pdf>

- 1010.01 General
- 1010.02 Definitions
- 1010.03 Work Zone Safety and Mobility
- 1010.04 Transportation Management Plans and Significant Projects
- 1010.05 Developing TMP Strategies
- 1010.06 Capacity Analysis
- 1010.07 Work Zone Design
- 1010.08 Temporary Traffic Control Devices
- 1010.09 Positive Protection Devices
- 1010.10 Other Traffic Control Devices or Features
- 1010.11 Traffic Control Plan Development and PS&E
- 1010.12 Training and Resources
- 1010.13 Documentation
- 1010.14 References

## 1010.01 General

Addressing work zone impacts to all road users is an important component in the design of a project and needs to be given adequate consideration early in the design process. Most work zones create some level of traffic impacts and require additional safety features; therefore, all work areas and operations needed for construction must be identified and addressed during the project design. Planners, designers, construction engineers, maintenance personnel, and others all play a role in developing a comprehensive work zone design. Consider including Rail, Freight, and Ports, Commercial Vehicle Services, and Public Transportation Divisions for help coordinating with freight and transit industries. See the WSDOT Project Management website for information on project teams.

This chapter provides the designer with guidance to develop comprehensive work zone strategies and plans to address a project's safety and mobility benefits/improvements for all modes, as well as constructability. A systematic process for addressing work zone impacts is required by federal regulations and state policy.

For the purposes of this chapter high speed means 45 mph and above.

## 1010.02 Definitions

The following terms are defined in the *Design Manual Glossary*: **transportation management area (TMA)**; **transportation management plan (TMP)**; **work zone**; **work zone impact**; **work zone traffic control**; **traveling public**.

## **1010.03 Work Zone Safety and Mobility**

Washington State Department of Transportation (WSDOT) policy per [Executive Order E 1001, Work Zone Safety and Mobility](#), is intended to support systematic consideration and management of work zone impacts across all stages of project development.

The policy states:

*All WSDOT employees are directed to make the safety of workers and the traveling public our highest priority during roadway design, construction, maintenance, and related activities.*

Designers should be familiar with this document. The policy defines how WSDOT programs address work zone safety and mobility issues during project planning, design, and construction.

## **1010.04 Transportation Management Plans and Significant Projects**

### **1010.04(1) Transportation Management Plan (TMP)**

A transportation management plan is a set of strategies for managing the corridor-wide work zone impacts of a project. A TMP is required for all projects and is the key element in addressing all work zone safety and mobility impacts. The TMP development begins in the scoping phase of a project by assessing impacts known at the time and then selecting mitigating strategies and design solutions to manage those impacts. It is very important to continue the development of the TMP throughout the project development process.

Not all work zone impacts have to be addressed with traffic control plans only. Many work zone impacts can be reduced or eliminated through project design elements like alignment choice, materials selection, structure types, overbuilding, and phased construction. Work zone impacts related to work duration may be resolved or reduced through innovative bidding and contract administration.

The three major components of a TMP are described below.

#### **1010.04(1)(a) Temporary Traffic Control (TTC)**

The TTC components are those strategies for directing traffic through the work zone and minimizing the duration of the impacts. These components are to be included in the Plans, Specifications, and Estimates (PS&E) as traffic control plans (TCPs) and contract provisions. The TTC components may include but are not limited to the following strategies:

- TTC strategies such as lane closures or shifts, one-lane two-way operations (flagging and or pilot car), staged construction, or full road closures and detours.
- Traffic Control Devices such as temporary signing, channelizing devices (cones, drums), changeable message signs, arrow boards, temporary signals, and temporary pavement markings.
- Corridor Project Coordination, Contracting Strategies, and Innovative Construction Strategies such as A+B bidding, incentives/disincentives, and precast members or rapid cure materials.

### **1010.04(1)(b) Transportation Operations (TO)**

The TO components are those strategies for improving traffic flow and safety through the work zone. Some of these strategies may be included in the PS&E, but could also be WSDOT-managed elements outside the contract. The TO components may include but are not limited to the following strategies:

- Demand Management Strategies such as Transit service improvements, transit incentives, and park & ride promotion.
- Corridor/Network Management (traffic operations) Strategies such as Signal timing/coordination improvements, temporary signals, bus pullouts, reversible lanes, and truck/heavy-vehicle restrictions.
- Work Zone Safety Management Strategies such as Positive protective device use, speed limit reductions, and automated flagger assistance devices.
- Traffic/Incident Management and Enforcement Strategies such as Work Zone Intelligent Transportation Systems (ITS), Washington State Patrol, tow service, WSDOT Incident Management vehicle(s), and traffic screens.

### **1010.04(1)(c) Public Information (PI)**

The PI components are those strategies for raising awareness of the upcoming project impacts or current restrictions. Public awareness strategies may be developed and implemented by WSDOT through the region or Headquarters (HQ) Communications offices and implemented before and during construction. Motorist information strategies may be WSDOT-managed elements with state equipment outside the contract or identified on plans in the PS&E. The PI components may include, but are not limited to, the following strategies:

- Public Awareness Strategies such as Brochures or mailers, press releases, paid advertisements, and project website (consider providing information in other languages if appropriate).
- Motorist Information Strategies such as Highway advisory radio (HAR), changeable message signs, and transportation management center (TMC).

It is very important to continue the development of the TMP throughout the project development process. Not all work zone impacts have to be addressed with traffic control plans only. Many work zone impacts can be reduced or eliminated through project design elements like alignment choice, materials selection, structure types, overbuilding, and phased construction. Work zone impacts related to work duration may be resolved or reduced through innovative bidding and contract administration.

The TMP Checklist in [Exhibit 1010-3](#) will help identify and organize TMP components. Include the completed checklist in the Project File. For significant projects, develop this checklist and the supporting plans, data, impacts assessment, strategies, capacity/delay analysis and endorsements into a formal TMP document to be included in the Project File. For TMP examples, see:

🔗 [http://www.ops.fhwa.dot.gov/wz/resources/final\\_rule/tmp\\_examples/sample\\_tmpls.htm](http://www.ops.fhwa.dot.gov/wz/resources/final_rule/tmp_examples/sample_tmpls.htm)

🔗 [http://www.ops.fhwa.dot.gov/wz/resources/publications/trans\\_mgmt\\_plans/trans\\_mgmt\\_plans.pdf](http://www.ops.fhwa.dot.gov/wz/resources/publications/trans_mgmt_plans/trans_mgmt_plans.pdf)

## 1010.04(2) Significant Projects

The FHWA definition of a “significant project” is as follows:

*A significant project is one that, alone or in combination with other concurrent projects nearby, is anticipated to cause sustained work zone impacts that are greater than what is considered tolerable based on state policy and/or engineering judgment.*

*All Interstate system projects within the boundaries of a designated Transportation Management Area (TMA) that occupy a location for more than three days with either intermittent or continuous lane closures shall be considered as significant projects.*

**Note: Significant projects require a Transportation Management Plan document addressing safety and mobility impacts with strategies or elements from all three TMP components. The size and scale of the TMP document will depend on the project’s complexity and impacts. For examples of WSDOT TMP’s see: <http://www.wsdot.wa.gov/Safety/WorkZones/resources.htm>**

For projects not identified as significant, the Temporary Traffic Control components included in the PS&E will be considered the TMP. Transportation Operations and Public Information components may also be required to properly address the impacts as many projects can have significant work zone safety and mobility impacts, but are not necessarily a significant project as defined under the federal requirements stated above. Consider developing a TMP document for these types of projects as well.

The Project Summary must include a Work Zone Strategy Statement and indicate whether the project is significant in regard to work zone impacts.

Significant projects may require a Value Engineering (VE) study (see [Chapter 310](#)) and a Cost Risk Assessment (CRA) or Cost Estimate Validation Process (CEVP) that could help define strategies or identify risks: [www.wsdot.wa.gov/projects/projectgmt/riskassessment/](http://www.wsdot.wa.gov/projects/projectgmt/riskassessment/)

## 1010.05 Developing TMP Strategies

### 1010.05(1) Key Considerations

The following list is intended to alert the designer to actions and issues that need to be addressed as part of a TMP. Addressing these items is required per WSDOT’s work zone policy and federal regulations, and they are key to the successful development of a project’s TMP.

- Determine work zone impacts through an impact assessment process.
- Minimize, mitigate, and manage work zone impacts.
- Integrate work zone impacts strategies early, during planning, programming, and design.
- Develop an accurate scoping estimate based on the work zone strategies.
- Hold a Work Zone Design Strategy Conference early in the design process. (Include bridge, construction, traffic, maintenance, freight, transit, local agency, and law enforcement personnel.)
- Utilize the Work Zone TMP Checklist/TMP document (required for significant projects).
- Emphasize flagger safety.



- Assess work zone mobility through a capacity analysis.
- Integrate project constructability, work efficiency and cost containment into the work zone strategy.
- Attend work zone training.
- Address Washington State traffic and safety regulations as provided for by state law.
- Use the legally adopted *Manual on Uniform Traffic Control Devices* (MUTCD), with Washington State modifications as the minimum standard.
- Provide an appropriate level of traffic control plans (TCPs).
- Consider work zone ITS elements.
- Use established design criteria in work zone roadway and roadside design.
- Accommodate pedestrian access (including ADA requirements) and maintenance of existing transit stops and bicycle traffic.
- Consider maintenance issues and needs through the duration of the project.
- Consider school, hospital, emergency services, and postal delivery, impacts.
- Consider economic impacts (business access) due to traffic delay or restricted access.
- Consider freight mobility; total roadway widths to less than 16 feet should be avoided if possible. Truck routes can be found here:  
<http://www.wsdot.wa.gov/Freight/EconCorridors.htm>
- Address traffic impacts extending beyond the project limits and impacting other roads.
- Identify seasonal or special event impacts that affect recreation or business due to work zone impacts.
- Consider risk management and tort liability exposure.
- Approach the work zone design from the road user's perspective.
- Incorporate worker safety needs (positive protection) in your work zone designs.
- Account for all needed work areas, operations and possible staging areas.
- Address work vehicle ingress and egress to each work area.
- Use of law enforcement

### **1010.05(2) Impacts Assessment**

One of the most important tasks in developing a TMP is assessing all of the project impacts to mobility and safety. Impacts that are not identified and addressed in the TMP will undoubtedly become issues during the construction phase of the project. A designer needs to possess a clear understanding of how project features will be constructed, including work methods, equipment, materials, and duration, to complete the work. Involve the construction PE when making decisions on assessing and addressing impacts.

A complete and accurate impacts assessment will allow for the development of an effective TMP that should only need minor modifications to address construction issues.

An early and ongoing impacts assessment allows time to:

- Develop TTC, TO, and PI strategies to address identified impacts as needed to effectively manage the project.
- Resolve potential work zone impacts within the design features of the project. Decisions that consider work zone impacts during bridge type selection, materials selection, advertisement dates, and others have the potential to resolve or minimize work zone impacts.

- Consider innovative mitigation strategies that may involve many stakeholders.

Some impacts may be difficult to completely solve and may ultimately need a management decision to determine the level of mitigation or impact that is acceptable. These types of impacts need to be clearly addressed in the TMP with documentation supporting and explaining the decision.

The following are some examples of impacts that need to be managed during the design of a project:

1. Bridge construction sequence or falsework opening plans need to match the TCC staging or channelization plans. Coordination with the HQ Bridge and Structures Office is essential as the bridge design schedule may differ than the project schedule. Maintain the legal height of 16 feet 6 inches as the minimum falsework opening whenever possible; anything less than this must consider overheight vehicle impacts, possible additional signing needs, and temporary bypass routes. Impacts to shoulder widths due to barrier or bridge staging may impact bicycle or pedestrian access and must be addressed in TCC plans. Refer to [Chapter 720](#) for additional requirements and approvals. Coordination with the Permits Office may be needed.
2. If existing signal and illumination systems are not able to be maintained during the construction phases, plans for temporary systems or connections need to be included in the project.
3. Temporary relocation of existing signing (including overhead signing) may be required and should be detailed in the plans.
4. Permanent traffic loop installation (such as advance loops, turn pockets, and stop bars, and ITS loops) and pavement marking installations (crosswalks, arrows, and so on) may require specific TTC plans.
5. What type of temporary marking is most appropriate for the installation, work duration, and the pavement surface? Will the final pavement surface have a “ghost stripe” potential?
6. Lane shifts onto existing shoulders:
  - Is the depth of the existing shoulder adequate to carry the extra traffic and are there rumble stripe that need to be removed?
  - Are there any existing catch basins or junction boxes located in the shoulder that cannot accept traffic loads over them?
  - What is the existing side slope rate? If steeper than 4H:1V, does it need mitigation? Are there existing roadside objects that, when the roadway is shifted, are now within the clear zone limits?
  - Shifting of more than one lane in a direction is only allowed with temporary pavement markings. Shifting lanes by using channelizing devices is not allowed due to the high probability that devices used to separate the traffic will be displaced.
  - Signal head alignment: When the lane is shifted approaching the intersection, is the signal head alignment within appropriate limits?
7. Roundabout construction at an existing intersection requires site-specific staging plans. Roundabouts create many unique construction challenges and each roundabout has very site-specific design features.

### **1010.05(3) Work Duration**

The duration of work is a major factor in determining a strategy and the amount and types of devices to use in traffic control work zones. A project may have work operations with durations that meet several or all of the following conditions:

#### **1010.05(3)(a) Long-Term Stationary Work Zone**

This is work that occupies a location continuously for more than three days. Construction signs should be post-mounted and larger; more stable channelizing devices should be used for increased visibility. Temporary barriers, pavement markings, illumination, and other considerations may be required for long-term stationary work. Staged construction or temporary alignment/channelization plans are required with this type of work.

#### **1010.05(3)(b) Intermediate-Term Stationary Work Zone**

This is work that occupies a location for up to three days. Signs may still be post-mounted if in place continuously. Temporary pavement markings, in addition to channelization devices, may be required for lane shifts. Barrier and temporary illumination would normally not be used in this work zone duration.

#### **1010.05(3)(c) Short-Term Stationary Work Zone**

This is work that occupies a location for more than one hour within a single day. At these locations, all devices are placed and removed during the single period.

#### **1010.05(3)(d) Short-Duration Work Zone**

This is work that occupies a location for up to one hour. Because the work time is short, the impact to motorists is usually not significant. Simplified traffic control set-ups are allowed, to reduce worker exposure to traffic. The time it may take to set up a full complement of signs and devices could approach or exceed the amount of time required to perform the work. Short-duration work zones usually apply to maintenance work and are not used on construction projects. (See [Work Zone Traffic Control Guidelines](#) for more information.)

#### **1010.05(3)(e) Mobile Work Zone**

This is work that moves intermittently or continuously. These operations often involve frequent stops for activities such as sweeping, paint striping, litter cleanup, pothole patching, or utility operations, and they are similar to short-duration work zones. Truck-mounted attenuators, warning signs, flashing vehicle lights, flags, and channelizing devices are used, and they move along with the work. When the operation moves along the road at low speeds without stopping, the advance warning devices are often attached to mobile units and move with the operation.

Pavement milling and paving activities are similar to mobile operations in that they can progress along a roadway several miles in a day. These operations, however, are not considered mobile work zones, and work zone traffic control consistent with construction operations is required.

### **1010.05(4) TMP Strategies**

With a completed impacts assessment, strategy development can begin. There are often several strategies to address a work zone impact, and engineering judgment will be needed in selecting the best option. Constructability, along with addressing safety and mobility, is the goal. Selecting

a strategy is often a compromise and involves many engineering and non-engineering factors. Work closely with bridge, construction, maintenance and traffic office personnel when selecting and developing strategies for the TMP and PS&E.

Do not assume that strategies chosen for past projects will adequately address the impacts for similar current projects. There may be similarities with the type of work, but each project is unique and is to be approached in that manner. Always look for other options or innovative approaches; many projects have unique features that can be turned to an advantage if carefully considered. Even a basic paving project on a rural two-lane highway may have opportunities for detours, shifting traffic, or other strategies.

For a list of work zone analysis tools, see: [□](#)

[http://ops.fhwa.dot.gov/wz/traffic\\_analysis/index.htm#tools](http://ops.fhwa.dot.gov/wz/traffic_analysis/index.htm#tools)

## **1010.05(5) Temporary Traffic Control (TTC) Strategies**

### **1010.05(5)(a) Lane Closure**

One or more traffic lanes are closed. A capacity analysis is necessary to determine the extent of congestion that may result. Night work or peak hour restrictions may be required. Use traffic safety drums and truck-mounted attenuators for freeway or expressway lane closures. Channelization devices should not encroach on the open freeway lanes; an additional lane should be closed if encroachment is necessary. Consider closing additional lanes to increase the lateral buffer space for worker safety.

### **1010.05(5)(b) Shoulder Closure**

A shoulder closure is used for work areas off the traveled way. On high-volume freeways or expressways, they should not be allowed during peak traffic hours. Channelization devices should not encroach on the open lanes of high-speed roadways.

### **1010.05(5)(c) Alternating One-Lane Two-Way Traffic**

This strategy involves using one lane for both directions of traffic. Flaggers are used to alternate the traffic movements.

If flaggers are used at an intersection, a flagger is required for each leg of the intersection. Only law enforcement personnel are allowed to flag from the center of an intersection. Close lanes and turn pockets so only one lane of traffic approaches a flagger station. When a signal is present, it shall be turned off or set to red flash mode when flagging.

Law enforcement personnel may be considered for some flagging operations and can be very effective where additional driver compliance is desired. The *Traffic Manual* contains information on the use of law enforcement personnel at work zones.

Flagger safety is a high emphasis area. Do not include alternating traffic with flaggers as a traffic control strategy until all other reasonable means of traffic control have been considered. Flagging stations need to be illuminated at night. Flaggers need escape routes in case of errant vehicles. Provide a method of alerting them to vehicles approaching from behind. Two-way radios or cellular phones are required to allow flaggers to communicate with one another. The flagger's location, escape route, protection, signing, and any other safety-related issues all need to be incorporated into the traffic control plan for the flagging operation. Flaggers are not to be

used on freeways or expressways. Using flaggers solely to instruct motorists to proceed slowly is an unacceptable practice.

Removing flaggers from the roadway during alternating traffic operations can be done with portable temporary traffic control signals or automated flagging assistance devices (AFAD). Portable signals work best when the length between signals will be 1,500 feet maximum and no accesses lie between the temporary signals. Each AFAD unit will need a flagger operating the device from a safe location off the roadway. A traffic control plan should show the advance signing and the AFAD or signal locations. Temporary stop bars, and lighting at the stop bars is required for signal use. For assistance on using these devices, contact the region Traffic Office.

Refer to [WAC 296-155-305](#) for flagging requirements.

### **1010.05(5)(d) Temporary Alignment and Channelization**

Temporary alignments and/or channelization may be an option for long-term work zones or staged traffic control. The following are guiding principles for the design of temporary alignment and channelization plans:

- Use site-specific base data to develop site-specific traffic control plans.
- Use permanent geometric design criteria.
- Provide beginning and ending station ties and curve data.
- Include lane and shoulder widths.
- Provide temporary roadway sections.
- To avoid confusion, do not show existing conflicting or unnecessary details on the plan.
- Do not use straight line tapers through curves; use circular alignment.
- Be aware of existing crown points, lane/shoulder cross slope breaks, and super-elevation transitions that may affect a driver's ability to maintain control of a vehicle.
- If the project has multiple stages, from one stage to the next, show newly constructed features as existing elements. For example, if an edge line is removed in one stage, the following stage would show the change by indicating where the new edge line is located.
- Consider the time needed for removal of existing markings and placement of the new markings and possibly placement of barriers and attenuators. In urban areas where work hours for lane closures are limited, special consideration may be necessary to allow time to implement the plan, or an interim stage may be necessary.
- Use shoulder closure signing and channelizing devices to close a shoulder prior to a temporary impact attenuator and run of temporary concrete barrier.
- Existing signing may need to be covered or revised, and additional construction warning signs may be needed for the new alignment.
- Temporary pavement marking types and colors should be specified. Long-duration temporary markings should be installed per the Standard Plans for permanent markings.
- For better guidance through shifting or taper areas, consider solid lane lines. Return to broken lane lines between shift areas.

- Provide a list of the approved temporary impact attenuators that may be used for the plan if applicable.
- The plans must provide all the layout information for all the temporary features just as a permanent pavement marking plan would.

#### **1010.05(5)(d)(1) Staged Construction**

Staged construction entails combining multiple work areas into a logical order to provide large protected work areas for long durations, which maximizes work operations and minimizes daily impacts to traffic. Temporary alignment and channelization plans must be designed to place traffic in these semi-permanent locations. Minimum geometric design criteria are to be used when developing these plans. Design strategies such as overbuilding for future stages or the use of temporary structures are often part of staged construction on significant impact projects or mega projects. Develop detailed capacity analysis and traffic modeling for each stage.

#### **1010.05(5)(d)(2) Lane Shift/Reduced Lane Width**

Traffic lanes may be shifted and/or width-reduced in order to accommodate a long-duration work area when it is not practicable, for capacity reasons, to reduce the number of available lanes. Shifting more than one lane of traffic requires the removal of conflicting pavement markings and the installation of temporary markings; the use of channelization devices to delineate multiple lanes of traffic is not allowed. Use advanced warning signs to show the changed alignment when the lateral shifting distance is greater than one-half of a lane width, and consider the use of solid lane lines through the shift areas.

Utilizing the existing shoulder may be necessary to accommodate the shifting movement. First, determine the structural capacity of the shoulder to ensure its ability to carry the proposed traffic. Remove and inlay existing shoulder rumble strips prior to routing traffic onto the shoulder.

#### **1010.05(5)(d)(3) Traffic Split or Island Work Zone**

This strategy separates lanes of traffic traveling in one direction around a work area. On higher-speed roadways, temporary barriers are provided to prevent errant vehicles from entering the work area. Some drivers have difficulty understanding "lane split" configurations, which sometimes results in poor driving decisions such as unnecessary or late lane changes. Braking and erratic lane changes decrease the traffic capacity through the work zone, which results in an unstable traffic flow approaching the lane split. Evaluate other strategies, such as overbuilding, to keep traffic on one side of the work area to avoid a traffic split if possible.

Consider the following guidance for traffic split operations:

- Define the work operation and develop the traffic control strategy around the specific operation.

- Limit the duration the traffic split can be in place. Consider incentives and disincentives to encourage the contractor to be as efficient as possible. A higher level of traffic impacts may be acceptable if offset with fewer impacted days.
- Advance warning signs advising drivers of the approaching roadway condition are required. Consider the use of Portable Changeable Message Signs (PCMS), portable Highway Advisory Radio (HAR), and other dynamic devices. Overhead signing and in-lane pavement markings also may be necessary to give additional driver notice of the traffic split.
- Consider how the operation will impact truck traffic. If the truck volumes are high, additional consideration may be prudent to control in which lane the trucks drive. If the trucks are controlled, it eliminates much of the potential for truck/car conflicts and sorts out undesirable truck lane changes through the work zone. For questions concerning truck operations, contact the HQ Freight Systems Division.
- To discourage lane changing, consider the use of solid lane line markings to delineate traffic approaching the split or island. Refer to the [MUTCD](#) for additional details.
- Consider the use of STAY IN LANE (black on white) signs, or set up a "no pass" zone approaching the lane split and coordinate with the Washington State Patrol (WSP).
- Supplement the existing roadway lighting with additional temporary lighting to improve the visibility of the island work area (see [exhibit in Chapter 1040](#)).
- Coordinate with the region Traffic Office for signing and pavement marking details when designing island work zones.

#### **1010.05(5)(d)(4) Temporary Bypass**

This strategy involves total closure of one or both directions of travel on the roadway. Traffic is routed to a temporary bypass usually constructed within the highway right of way. An example of this is the replacement of an existing bridge by building an adjacent temporary structure and shifting traffic onto the temporary structure. A temporary channelization plan will show pavement markings, barrier and attenuators, sign and device placement.

#### **1010.05(5)(d)(5) Median Crossover**

This strategy involves placing all multilane highway traffic on one side of the median. Lanes are usually reduced in both directions and one direction is routed across the median. The design for elements of temporary crossovers needs to follow the same guidance as permanent design for alignment, barriers, delineation, and illumination.

- Design crossovers for operating speeds not less than 10 mph below the posted speed limit unless unusual site conditions require a lower design speed.
- Median paving may be required to create crossover locations (consider drainage for the added pavement).



- Use temporary barrier to separate the two directions of traffic normally separated by a median barrier,
- Temporary illumination at the crossover locations (see [exhibit in Chapter 1040](#))
- Straight line crossover tapers work best for highways with narrow paved medians.
- Temporary pavement markings, removal of conflicting existing markings, and construction signs are also required.
- A good array of channelizing devices and properly placed pavement markings is essential in providing clear, positive guidance to drivers.
- Provide a clear roadside recovery area adjacent to the crossover. Consider how the roadway safety hardware (guardrail, crash cushions, and so on) may be impacted by the traffic using the crossover if the traffic is going against the normal traffic flow direction. Avoid or mitigate possible snagging potential. Avoid placing crossover detours near structures.

#### **1010.05(5)(e) Total Closures and Detours**

Total closures may be for the project duration or for a critical work operation that has major constructability or safety issues. The main requirement for total closures is the availability of a detour route and if the route can accommodate the increased traffic volumes and trucks turning movements. Local roads may have lower geometric criteria than state facilities. Placing additional and new types of traffic on a local road may create new safety concerns, especially when drivers are accustomed to the geometrics associated with state highways. Pavement integrity and rehabilitation may need to be addressed when traffic is detoured to specific local roadways.

For the traveling public, closing the road for a short time might be less of an inconvenience than driving through a work zone for an extended period of time (see the Traffic Manual and RCW 47.48). Advance notification of the closure is required, and a signed detour route may be required.

Consider the following road closure issues:

- Communication with all stakeholders, including road users, adjoining property owners, local agencies, transit agencies, the freight industry, emergency services, schools, and others, is required when considering a total closure strategy. This helps determine the level of support for a closure and development of an acceptable closure. Include Rail, Freight, and Ports; Commercial Vehicle Services; and Public Transportation Divisions to help coordinate.
- Analyze a closure strategy and compare it to other strategies, such as staged work zones, to determine which is overall more beneficial. This information helps stakeholders understand the impacts if a closure is not selected.
- A closure decision (other than short-term, minor-impact closures) will require stakeholder acceptance and management approval once impacts and benefits have been analyzed.

- Closures that reopen to a new, completed roadway or other noticeable improvements are generally more accepted by the public.
- Route-to-route connections and other strategic access points may have to be maintained or a reasonable alternative provided.
- Material selection, production rates, and work operation efficiencies have a direct tie to the feasibility of the closure strategy. A strong emphasis has been placed on this area and several successful strategies have been implemented, such as weekend-long closures or extended-duration single-shift closures. These strategies use specific materials such as quick-curing concrete, accelerated work schedules, prefabricated structure components, on-site mix plants, and so on, and are based on actual production rates. The WSDOT Materials Laboratory and the HQ Construction Office are good resources for more information on constructability as a component of an effective work zone strategy.
- Interstate or interstate ramp closures (including interstate closures with interchange ramps as detours) lasting more than 7 days require FHWA 60-day advance notice. (See the Stewardship and Oversight Agreement for closure notification requirements.)
- Short-duration closures of ramps or intersecting streets during off-peak hours do not require extensive approval if advance notice is provided and reasonable alternate routes are available.
- Detailed, project-specific traffic control plans, traffic operation plans, and public information plans are required.
- Depending on the duration of the closure/detour and the anticipated amount and type of traffic that will use the route, consider upgrades to the route such as signal timing, intersection turning radius for large vehicle, structural pavement enhancements, or shoulder widening.
- An approved detour agreement with the appropriate local agency is required for detour routes using local roadways and must be completed prior to project advertisement.
- Document road closure decisions and agreements in the Project File.

#### **1010.05(5)(f) Intermittent Closure**

This involves stopping all traffic for a short time to allow the work to proceed. Traffic volumes will determine the allowed duration of the closures. Typically, the closure would be limited to a ten-minute maximum and would occur in the lowest traffic volume hours. Equipment crossing and material delivery are where this type of closure may work well. Traffic is reduced to a single lane on a multilane highway, and a flagger or law enforcement is used to stop traffic.

#### **1010.05(5)(g) Rolling Slowdown**

Rolling slowdowns are commonly practiced by the Washington State Patrol (WSP) for emergency closures. They are a legitimate form of traffic control for contractors or utility and highway maintenance crews for very specific short-duration closures (to move large equipment across the highway, to pull power lines across the roadway, to switch traffic onto a new alignment, and so on). They are not to be used for routine work that can be addressed by lane closures or other formal traffic control strategies. Traffic control vehicles, during off-peak hours, form a moving blockade, which reduces traffic speeds and creates a large gap (or clear area) in

traffic, allowing very short-term work to be accomplished without completely stopping the traffic.

Consider other forms of traffic control as the primary choice before the rolling slowdown. A project-specific traffic control plan (TCP) must be developed for this operation. The TCP or contact provisions should list the work operations in which a rolling slowdown is allowed. The gap required for the work and the location where the rolling slowdown begins needs to be addressed on the TCP. Use of the WSP is encouraged whenever possible. Refer to the Standard Specifications and Work Zone Traffic Control Guidelines for additional information on rolling slowdown operations.

#### **1010.05(5)(h) Pedestrian and Bike Detour Route**

When existing pedestrian access routes and bike routes are disrupted due to construction activities, address detour routes with a traffic control plan. The plan must show enough detail and be specific enough to address the conflicts and ensure the temporary route is reasonably safe and adequate to meet the needs of the user. Also, consider the impacts to transit stops for pedestrians: Will the bus stops be able to remain in use during construction or will adjustments be necessary? (See [Chapter 1510](#) for pedestrian work zone design requirements.)

#### **1010.05(5)(i) Alternative Project Delivery**

To reduce construction times and minimize impacts to the traveling public, consider alternative delivery techniques to accomplish this. For more information, see:

<http://www.wsdot.wa.gov/projects/delivery/alternative/>

#### **1010.05(5)(j) Innovative Design/Construction Methods**

- Overbuild beyond normal project needs to maintain additional traffic or facilitate staged construction.
- Replace bridges using new alignments so they can be built with minimal impacts.
- Bring adjacent lifts of hot mix asphalt (HMA) to match the latest lifts (lag up), and require a tapered wedge joint to eliminate drop-off and abrupt lane edges to improve motorist safety.
- Require permanent pavement markings at intervals during multi-season projects to limit the duration temporary markings are needed and to avoid temporary marking issues during winter shut-down.

### **1010.05(6) *Transportation Operations (TO) Strategies***

#### **1010.05(6)(a) Demand Management**

- Provide transit service improvements and possible incentives to help reduce demand.
- For long-term freeway projects, consider ramp metering.
- Provide a shuttle service for pedestrians and bicyclists.
- Provide local road improvements (signals modifications, widening, and so on) to improve capacity for use as alternate routes.
- Provide traffic screens to reduce driver distraction.

### **1010.05(6)(b) Corridor/Network Management**

- Provide a temporary express lane with no access through the project.
- Consider signal timing or coordination modifications.
- Provide emergency pullouts for disabled vehicles on projects with long stretches of narrow shoulders and no other access points.
- Use heavy-vehicle restrictions and provide alternate routes or lane use restrictions.

### **1010.05(6)(c) Work Zone Safety Management**

- Provide temporary access road approaches for work zone access.
- Use positive protective devices (barrier) for long-term work zones to improve the environment for workers and motorists.
- Install intrusion alarms or vehicle arresting devices.
- Use speed limit reductions when temporary conditions create a need for motorist slow-downs. Refer to the *Traffic Manual* for additional information, guidance and approval requirements for speed limit reductions in work zones.

### **1010.05(6)(d) Traffic/Incident Management and Enforcement**

- Provide law enforcement patrols to reduce speeding and aggressive drivers.
- Provide incident response patrols during construction to reduce delays due to collisions in the work zone.
- Include work zone ITS elements in the project or coordinate with TMC to use existing equipment.
- Provide a dedicated tow service to clear incidents.

## **1010.05(7) Public Information (PI) Strategies**

### **1010.05(7)(a) Public Awareness**

One PI strategy is a public awareness campaign using the media, project websites, public meetings, e-mail updates, and mailed brochures. This gives regular road users advance notice of impacts they can expect and time to plan for alternate routes or other options to avoid project impacts. Involve the region or HQ Communications Office in developing and implementing these strategies. Coordinate transit travel information and restrictions with the Public Transportation Division. <http://wwwi.wsdot.wa.gov/PubTran/>

Coordinate freight travel information and restrictions with the Rail, Freight, and Ports Division.

<http://www.wsdot.wa.gov/freight/>

<http://www.wsdot.wa.gov/Freight/Trucking/default>

### **1010.05(7)(b) Driver Information**

In addition to work zone signs, provide driver information using highway advisory radio (HAR) and changeable message signs (existing or portable). Provide additional work zone ITS features that could include traffic cameras or queue detection along with changeable message signs to

provide drivers with real time information on delays and traffic incidents. Involve the region TMC in the development and implementation of these strategies. Additional information on work zone ITS can be found on the Work Zone Safety web page:

[www.wsdot.wa.gov/safety/workzones/](http://www.wsdot.wa.gov/safety/workzones/)

The Freight Alert system should be used to communicate information with freight industry on work zones. Each region has the capability to send alerts with this system.

<http://www.wsdot.wa.gov/freight/>

Work zone strategy development is a fluid process and may be ongoing as project information and design features are developed during the design process. There may be many factors involved with strategy development, and it is necessary to be well organized to make sure all the relative factors are identified and evaluated.

### **1010.05(7)(c) Pedestrian and Bicycle Information**

Include pedestrian and bicycle access information and alternate routes in the public awareness plans. Pedestrian and bicyclist information signing, including alternate route maps specifically for these road users, could be considered.

## **1010.06 Capacity Analysis**

Work zone congestion and delay is a significant issue for many highway projects. At high-volume locations with existing capacity problems, even shoulder closures will increase congestion.

All work zone traffic restrictions need to be analyzed to determine the level of impacts. Short-term lane closures may only require work hour restrictions to address delays; long-term temporary channelization, realignments, lane shifts, and more will require a detailed capacity analysis to determine the level of impact. Demand management and public information strategies may be required to address delays. Traffic capacity mitigation measures are important since many projects cannot effectively design out all the work zone impacts. Include a [Work Zone & Traffic Analysis](#) in the TMP.

Work zone mobility impacts can have the following effects:

- **Crashes:** Most work zone crashes are congestion-related, usually in the form of rear-end collisions due to traffic queues. Traffic queues beyond the advance warning signs increase the risk of crashes.
- **Driver Frustration:** Drivers expect to travel to their destinations in a timely manner. If delays occur, driver frustration can lead to aggressive or inappropriate driving actions.
- **Constructability:** Constructing a project efficiently relies on the ability to pursue work operations while maintaining traffic flow. Delays in material delivery, work hour restrictions, and constant installation and removal of traffic control devices all detract from constructability.
- **Local Road Impacts:** Projects with capacity deficiencies can sometimes cause traffic to divert to local roadways, which may impact the surrounding local roadway system and community.
- **Public Credibility:** Work zone congestion and delay can create poor credibility for WSDOT with drivers and the surrounding community in general.

- **Restricted Access:** Severe congestion can effectively gridlock a road system, preventing access to important route connections, businesses, schools, hospitals, and so on.
- **User Cost Impacts:** Traffic delays have an economic impact on road users and the surrounding community. Calculated user costs are part of a work zone capacity analysis and may be used to determine liquidated damages specifications.

WSDOT has a responsibility to maintain traffic mobility through and around its projects. The goal is to keep a project's work zone traffic capacity compatible with existing traffic demands. Maintaining the optimum carrying capacity of an existing facility during construction may not be possible, but an effort must be made to maintain existing traffic mobility through and/or around the work zone.

Maintaining mobility does not rule out innovative strategies such as roadway closures. Planned closures can accelerate work operations, reducing the duration of impacts to road users. These types of traffic control strategies must include demand management and public information plans to notify road users and mitigate and manage the impacts as much as possible.

A capacity analysis helps determine whether a work zone strategy is feasible. Mitigation measures that provide the right combination of good public information, advance signing and notification, alternate routes, detours, and work hour restrictions, as well as innovations such as strategic closures, accelerated construction schedules, or parallel roadway system capacity improvements, can be very effective in reducing mobility impacts.

Some of the impact issues and mitigating measures commonly addressed by traffic analyses include:

- Work hour time restrictions
- Hourly liquidated damage assessment
- Use of staged construction
- Working day assessment
- Public information campaign
- User cost assessment
- Local roadway impacts
- Special event and holiday time restrictions
- Closure and detour options
- Mitigation cost justification
- Level of service
- Queue lengths
- Delay time
- Running speed
- Coordination with adjoining projects (internal and local agency)

Many projects will have several potential work zone strategies, while other projects may only have one obvious work zone strategy. It is possible that a significant mobility impact strategy may be the only option. TMP strategies still need to be considered. An analysis will help show the results of these mitigating measures.

There is no absolute answer for how much congestion and delay are acceptable on a project; it may ultimately become a management decision.

Reductions in traffic capacity are to be mitigated and managed as part of the TMP. The traffic analysis process helps shape the TMP as the work zone strategies are evaluated and refined into traffic control plans and specifications. Maintain analysis documents in the Project File.

### **1010.06(1) Collecting Traffic Volume Data**

Current volume data in the project vicinity is required for accurate traffic analysis results. Seasonal adjustment factors may be needed depending on when the data was collected and when the proposed traffic restrictions may be in place. Assess existing data as early as possible to determine whether additional data collection may be required. The region Traffic Office and the HQ Transportation Data & GIS Office can assist with collecting traffic volume data. Coordination with local agencies may be needed to obtain data on affected local roads.

### **1010.06(2) Short-Term Lane Closure Work Zone Capacity**

For short-term lane closures on multilane highways or alternating one-way traffic on two-lane highways, see Exhibit 1010-1. It provides information for a quick analysis when compared to current hourly volumes on the highway. The basic traffic analysis programs QUEWZ 98, along with hourly volume input, the number of lanes to be closed, the hours of closure, and other default information, will output queue length, delay time, user costs, and running speed.

**Exhibit 1010-1 General Lane Closure Work Zone Capacity**

Roadway Type	Work Zone Capacity
Multilane Freeways/Highways	1300 VPHPL*
Multilane Urban/Suburban	600 VPHPL*
Two-Lane Rural Highway	400 VPHPL/ 800 VPH total*
*These are average capacity values. The actual values would be dependent on several factors, which include the existing number of lanes, number of lanes closed, traffic speed, truck percentage, interchanges/intersections, type of work, type of traffic control, and seasonal factors (among others). For further information, consult the <i>Highway Capacity Manual</i> .	

### **1010.06(3) Long-Term Work Zone Capacity**

For complex strategies that change traffic patterns, a more detailed analysis is required using advanced traffic modeling software. These strategies could include reducing lane and shoulder widths for extended lengths, reducing the number of lanes for extended durations, moving all lanes of traffic onto a temporary alignment, changing access locations to and from the highway, or closures with detours (including public information and traffic operation plans with anticipated reduction in demand). Work with the region Traffic Office for assistance with this level of analysis.

The following resources are also available to assist with the actual analysis and mitigation strategy development upon request:

- HQ Transportation Data & GIS Office



- HQ Traffic Offices
- Region Work Zone Specialist
- Region Public Information Office

Training is also available to obtain further knowledge and expertise in traffic analysis (see 1010.12).

## **1010.07 Work Zone Design**

Part 6 of the [MUTCD](#) mostly addresses short-duration temporary traffic control standards. Some long-duration work zones may require temporary alignments and channelization, including barrier and attenuator use, temporary illumination and signals, and temporary pedestrian and bicycle routes. Refer to the *Design Manual's* chapters for permanent features for design guidance.

### **1010.07(1) Lane Widths**

Maintain existing lane widths during work zone operations whenever practicable.

For projects that require lane shifts or narrowed lanes due to work area limits and staging, consider the following before determining the work zone lane configurations to be implemented:

- Overall roadway width available
- Posted speed limit
- Traffic volumes through the project limits
- Number of lanes
- Existing lane and shoulder widths
- Crown points and shoulder slope breaks
- Treat lane lines and construction joints to provide a smooth flow
- Length and duration of lane width reduction (if in place)
- Roadway geometry (cross slope, vertical and horizontal curves)
- Vertical clearances
- Transit and freight vehicles, including over-sized vehicles

Work zone geometric transitions should be minimized or avoided if possible. When necessary, such transitions should be made as smoothly as the space available allows. Maintain approach lane width, if possible, throughout the connection. Design lane width reductions prior to any lane shifts within the transition area. Do not reduce curve radii and lane widths simultaneously.

When determining lane widths, the objective is to use lane geometrics that will be clear to the driver and keep the vehicle in the intended lane. In order to maintain the minimum lane widths, temporary widening may be needed.

## **1010.07(2) Buffer Space**

Buffer spaces separate road users from the work space or other areas off limits to travel. Buffer spaces also might provide some recovery space for an errant vehicle.

- A lateral buffer provides space between the vehicles and adjacent work space, traffic control device, or a condition such as an abrupt lane edge or drop-off. As a minimum, a 2-foot lateral buffer space is used. Positive Protective Devices may be required if workers are within one lane width of traffic. When temporary barriers are used, place a temporary edge line 2-foot laterally from the barrier.
- When feasible, a longitudinal buffer space is used immediately downstream of a closed or shifted traffic lane or shoulder. This space provides a recovery area for errant vehicles as they approach the work space.

Devices used to separate the driver from the work space should not encroach into adjacent lanes. If encroachment is necessary, it is recommended to close the adjacent lane to maintain the lateral buffer space.

In order to achieve the minimum lateral buffer, there may be instances where pavement widening or a revision to a stage may be necessary. In the case of short-term lane closure operations, the adjacent lane may need to be closed or traffic may need to be temporarily shifted onto a shoulder to maintain a lateral buffer space. During the design of the traffic control plan, the lateral buffer needs to be identified on the plan to ensure additional width is available; use temporary roadway cross sections to show the space in relation to the traffic and work area.

## **1010.07(3) Work Zone Clear Zone**

The contractor's operations present opportunities for errant vehicles to impact the clear area adjacent to the traveled way. A work zone clear zone (WZCZ) is established for each project to ensure the contractor's operations provide an appropriate clear area. The WZCZ addresses items such as storage of the contractor's equipment and employee's private vehicles and storage or stockpiling of project materials. The WZCZ applies during working and nonworking hours and applies only to roadside objects introduced by the contractor's operations. It is not intended to resolve preexisting deficiencies in the Design Clear Zone or clear zone values established at the completion of the project. Those work operations or objects that are actively in progress and delineated by approved traffic control measures are not subject to the WZCZ requirements.

Minimum WZCZ values are presented in Exhibit 1010-2. WZCZ values may be less than Design Clear Zone values due to the temporary nature of the construction and limitations on horizontal clearance. To establish an appropriate project-specific WZCZ, it may be necessary to exceed the minimum values. The following conditions warrant closer scrutiny of the WZCZ values, with consideration of a wider clear zone:

- Outside of horizontal curves or other locations where the alignment presents an increased potential for vehicles to leave the traveled way.
- The lower portion of long downgrades or other locations where gradient presents an increased potential for vehicles to exceed the posted speed.

- Steep fill slopes and high traffic volumes. (Although it is not presented as absolute guidance, the Design Clear Zone exhibit in [Chapter 1600](#) may be used as a tool to assess increases in WZCZ values.)

**Exhibit 1010-2 Minimum Work Zone Clear Zone Distance**

Posted Speed	Distance From Traveled Way (ft)
35 mph or less	10
40 mph	15
45 to 55 mph	20
60 mph or greater	30

**1010.07(4) Abrupt Lane Edges and Drop-offs**

Minimize, mitigate, or eliminate abrupt lane edges and drop-offs whenever practicable. When unavoidable, traffic control plans should provide a protection method. Consider temporary barriers for long duration drop off protection and contract provisions limiting the duration of edges from daily paving operations. Abrupt edges up to 0.20 foot may remain exposed with appropriate warning signs alerting motorists of the condition. Edges or drop-offs more than 0.20 foot are not allowed in the traveled way or auxiliary lane.

The best long duration protection method for drop-offs more than 0.20 feet is Temporary Barrier. Place barrier on the traffic side of the drop-off with 2 feet between the drop-off and the back of the barrier and a provide a new edge line on the traffic side of the barrier with a 2-foot lateral buffer space minimum. The space behind the barrier can be reduced if the barrier is anchored. Barrier end attenuators may be required.

Open trenches within the traveled way or auxiliary lane shall have a steel-plate cover placed and anchored over them. A wedge of suitable material, if required, shall be placed for a smooth transition between the pavement and the steel plate. Warning signs shall be used to alert motorists of the presence of the steel plates.

Abrupt lane edges, and drop-offs and steel plates require additional warning and considerations for motorcyclists, bicyclists, and pedestrians, including pedestrians with disabilities. Adequate signing to warn the motorcycle rider, bicyclists and pedestrians, including pedestrians with disabilities of these conditions is required. (See [RCW 47.36.200](#) and [WAC 468-95-305](#).) See *Design Manual Chapter 1510* for work zone pedestrian accommodation guidance.

See *Standard Specifications* section 1-07.23(1) for the contract requirements for drop off protection and address project specific protection if necessary.

**1010.07(5) Vertical Clearance**

In accordance with [Chapter 720](#), the minimum vertical clearance over new highways is 16.5 feet. Anything less than the minimum must follow the reduced clearance criteria discussed in Chapter 720 and be included in the temporary traffic control plans. Maintain legal height on temporary falsework for bridge construction projects. Anything less than this must consider over-height vehicle impacts and possible additional signing needs and coordination with permit offices. Widening of existing structures can prove challenging when the existing height is at or less than

legal height, so extra care is required in the consideration of over-height vehicles when temporary falsework is necessary. Coordination with the HQ Bridge and Structures Office is essential to ensure traffic needs have been accommodated. Vertical clearance requirements associated with local road networks may be different than what is shown in [Chapter 720](#). Coordinate with the local agency.

### **1010.07(6) *Reduced Speeds in Work Zones***

Drivers tend to reduce their speed only if they perceive a need to do so. Reduced speed limits should only be used to address an altered geometry when not able to meet design standards for the existing speed, when the roadway will be narrowed with minimal shy distance to barriers, when roadway conditions warrant a reduction like BST operations, and when there will be workers on foot within a lane width of high-speed high-volume traffic without positive protection devices in place. Speed reductions are not applied as a means for selecting lower work zone design criteria (tapers, temporary alignment, device spacing, and so on).

Speed limit reductions are categorized as follows:

- Continuous Regulatory Speed Limit Reduction: A speed reduction in place 24 hours a day for the duration of the project, stage, or roadway condition.
- Variable Regulatory Speed Limit Reduction: A speed reduction in place only during active work hours (Class B construction signs may be used). This is a good option when positive protection devices are not used.
- Advisory Speed Reduction: In combination with a warning sign, an advisory speed plaque may be used to indicate a recommended safe speed through a work zone or work zone condition. Refer to the [MUTCD](#) for additional guidance.

Refer to the [Traffic Manual](#) for additional information, guidance and approval requirements for speed limit reductions in work zones. Include approval documents in the Project File.

### **1010.07(7) *Accommodation for Pedestrians and Bicyclists***

Many public highways and streets accommodate pedestrians and bicyclists, predominately in urban areas. During construction, access must be maintained through or around the work zones. When existing pedestrian routes that are accessible to pedestrians with disabilities are closed, the alternate routes must be designed and constructed to meet or exceed the existing level of accessibility. Temporary pedestrian facilities within the work zone must meet accessibility criteria to the maximum extent feasible. (See [Chapter 1510](#) for pedestrian circulation path and pedestrian access route accessibility criteria.) Covered walkways are to be provided where there is a potential for falling objects.

In work areas where the speeds are low (25 mph), or the ADT is 2,000 or less, bicyclists can use the same route as motorized vehicles. For work zones on higher-speed facilities, bicyclists will need a minimum 4-foot shoulder or detour route to provide passage through or around a work zone. Bicyclists may be required to dismount and walk their bikes through a work zone on the route provided for pedestrians.

It may be possible to make other provisions to transport pedestrians and bicyclists through a work zone or with a walking escort around the active work area. Roadway surfaces are an important consideration for pedestrian and bicycle use. Unacceptable conditions such as loose

gravel, uneven surfaces, milled pavement, and asphalt tack coats endanger the bicyclist and restrict access to pedestrians with disabilities.

Information can be gathered on bike issues by contacting local bike clubs. Coordination with local bike clubs goes a long way to ensuring their members are notified of work zone impacts, and it helps maintain good public relations. (See [Chapter 1520](#) for more bicycle design requirements and [Chapter 1510](#) and [MUTCD Chapter 6D](#) for pedestrian work zone design requirements.)

### **1010.07(8) Motorcycles**

The same road surfaces that are a concern for bicyclists are also a concern for motorcyclists. Stability at high speed is a far greater concern for motorcycles than cars on grooved pavement, milled asphalt, and transitions from existing pavement to milled surfaces. Contractors must provide adequate warning signs for these conditions to alert the motorcycle rider. For regulations on providing warnings to motorcyclists, see [RCW 47.26.200](#).

### **1010.07(9) Oversized Vehicles**

The region Maintenance offices and the HQ Commercial Vehicle Services Office issue permits to allow vehicles that exceed the legal width, height, or weight limits to use certain routes. If a proposed work zone will reduce roadway width or vertical clearance, or have weight restrictions, adequate warning signs and notification to the HQ Commercial Vehicle Services Office and the appropriate region Maintenance Office is required as a minimum. When the total width of a roadway is to be reduced to less than 16 feet for more than three days, communication with these offices and any other stakeholders is required; include documentation in the Project File. The contract documents shall include provisions requiring the contractor to provide a 30-calendar-day notice prior to placing the restriction.

In the permit notification, identify the type of restriction (height, weight, or width) and specify the maximum size that can be accommodated. On some projects, it may be necessary to designate a detour route for oversized vehicles. An important safety issue associated with oversized loads is that they can sometimes be unexpected in work zones, even though warning and restriction or prohibition signs may be in place. Some oversized loads can overhang the temporary barrier or channelization devices and endanger workers. Consider the potential risk to those within the work zone. Routes with high volumes of oversized loads or routes that are already strategic oversized load routes may not be able to rely only on warning or prohibition signs. Protective features or active early warning devices may be needed. If the risk is so great that one oversized load could potentially cause significant damage or injury to workers, failsafe protection measures may be needed to protect structures and workers. The structure design, staging, and falsework openings may need to be reconsidered to safely accommodate oversized loads.

### **1010.08 Temporary Traffic Control Devices**

FHWA regulations require that devices such as portable sign stands, barricades, traffic barriers, barrier terminals, crash cushions, and work zone hardware be compliant with the National Cooperative Highway Research Program (NCHRP) Report 350 or the Manual for Assessing Safety Hardware (MASH) crash test requirements.

### **1010.08(1) Channelizing Devices**

Channelizing devices are used to alert and guide road users through the work zone. They are used to channelize traffic away from the work space, pavement drop-offs, or opposing directions of traffic. Traffic Safety Drums are the preferred devices on freeways and expressways as they are highly visible and are less likely to be displaced by traffic wind. 28-inch cones are also used on WSDOT projects. They are a good choice for flagging operations. Tall channelization devices are 42-inch cone-type devices and should be used in place of tubular markers to separate opposing traffic. Tubular markers are not a recommended device unless they are being used to separate traffic on low-volume low-speed roadways. Longitudinal channelizing devices are interconnected devices that provide channelization with no gaps. These devices look like a temporary barrier, but are not approved as a positive protective device. Barricades are a channelization device mostly used to supplement other channelization devices in traffic control operations involving road, ramp, or sidewalk closures.

### **1010.08(2) Construction Signs**

Portable and temporary signs (Class B Construction Signs) are generally used in short-term work zones. They are set up and removed daily or frequently repositioned as the work moves along the highway. These signs are mounted on crashworthy, collapsible sign supports. The minimum mount height is 1 foot above the roadway, but there are temporary sign supports that will provide 5- to 7-foot mounting heights. This may be useful when temporary signs are mounted behind channelizing device or in urban areas with roadside parking that may obstruct sign visibility and multilane facilities. Temporary signs need to be placed such that they do not obstruct pedestrian facilities. Warning signs in place longer than three days at one location must be post-mounted.

Fixed signing (Class A Construction Signs) are the signs mounted on conventional sign supports along or over the roadway. This signing is used for long-term stationary work zones. Details for their design are in [Chapter 1020](#) and the [Standard Plans](#). Sign messages, color, configuration, and usage are shown in the [MUTCD](#) and the [Sign Fabrication Manual](#). Existing signs may need to be covered, removed, or modified during construction.

### **1010.08(3) Warning Lights**

Warning lights are either flashing or steady burn and can be mounted on channelizing devices, barriers, and signs. Secure crashworthy mounting of warning lights is required.

- **Type A:** Low-intensity flashing warning light used on a sign or barricade to warn road users during nighttime hours that they are approaching a work zone.
- **Type B:** High-intensity flashing warning light used on a sign or barricade to warn road users during both daytime and nighttime hours.
- **Type C and Type D 360 degree:** Steady-burn warning lights designed to operate 24 hours a day to delineate the edge of the roadway.

### **1010.08(4) Arrow Board**

The arrow board (Sequential Arrow Sign) displays either an arrow or a chevron pointing in the direction of the intended route of travel. Arrow board displays are required for lane closures on multilane roadways. When closing more than one lane, use an arrow board display for each lane

reduction. Place the arrow board at the beginning of the transition taper and out of the traveled way. The caution display (four corner lights) is only used for shoulder work. Arrow boards are not used on two-lane two-way roadways.

### **1010.08(5) *Portable Changeable Message Signs (PCMS)***

PCMS have electronic displays that can be modified and programmed with specific messages and may be used to supplement other warning signs. These signs are usually trailer mounted with solar power and batteries to energize the electronic displays. A two-second display of two messages is the recommended method to ensure motorists have time to read the sign's message twice. These devices are not crashworthy and should be removed when not in use, or placed behind barrier or guardrail. PCMS are best used to provide notice of unexpected situations like the potential for traffic delays or queuing and to provide a notice of future closures or restrictions. They should not be used in place of required signs or to provide redundant information.

### **1010.08(6) *Portable Temporary Traffic Control Signals***

These versatile trailer-mounted portable signals are battery powered, with the ability to be connected to AC power. They can operate on fixed timing or be traffic actuated. They are typically used on two-lane two-way highways to alternate traffic in a single lane for extended durations.

### **1010.08(7) *Portable Highway Advisory Radio (HAR)***

HAR can be used to broadcast AM radio messages about work zone traffic and travel-related information. The system may be a permanently located transmitter or a portable trailer-mounted system that can be moved from location to location as necessary. Contact the region Traffic Office for specific guidance and advice on the use of these systems.

### **1010.08(8) *Automated Flagger Assistance Device (AFAD)***

An AFAD is a flagging machine that is operated remotely by a flagger located off the roadway and away from traffic. This device could be used to enhance safety for flaggers on highways with reduced sight distance or limited escape routes. A traffic control plan is required for use of the AFAD. A flagger is required to operate each device.

Refer to the [MUTCD](#) for additional guidance on temporary traffic control zone devices.

## **1010.09 Positive Protection Devices**

Channelizing devices will not provide adequate worker and road user protection in some work zones. Positive protective devices are required for the following conditions unless an engineering study determines otherwise:

- To separate opposing high-speed traffic normally separated by a median or existing median barrier.
- Where existing traffic barriers or bridge railings are to be removed.
- For drop-off protection during widening or excavations (see [Standard Specification 1-07.23\(1\)](#)).



- When temporary slopes change clear zone requirements.
- For bridge falsework protection.
- When equipment or materials must remain in the work zone clear zone.
- When newly constructed features in the clear zone will not have permanent protection until later in the project.
- Where temporary signs or light standards are not crashworthy.
- To separate workers from motorized traffic when work zone offers no means of escape for the worker, such as tunnels, bridges, and retaining walls, or for long-duration worker exposure within one lane-width of high-speed high-volume traffic.

### **1010.09(1) Temporary Barriers**

Providing temporary barrier protection may become the key component of the work zone strategy. Barrier use usually requires long-term stationary work zones with pavement marking revisions, and will increase the traffic control costs of a project. The safety benefit versus the cost of using barrier requires careful consideration, and cost should not be the only or primary factor determining the use of barrier. (See [Chapter 1610](#) for guidance on barriers.)

#### **1010.09(1)(a) Temporary Concrete Barriers**

These are the safety-shape barriers shown in the Standard Plans. Lateral displacement from impacts is usually in the range of 2 to 4 feet. (See [Chapter 1610](#) for detailed information on deflection.) When any barrier displacement is unacceptable, these barriers are anchored to the roadway or bridge deck. Some deflection with anchored systems is still expected.) Anchoring systems are also shown in the Standard Plans.

#### **1010.09(1)(b) Movable Barriers**

Movable barriers are specially designed segmental barriers that can be moved laterally one lane width or more as a unit with specialized equipment. This allows strategies with frequent or daily relocation of a barrier. The ends of the barrier must be located out of the clear zone or fitted with an impact attenuator. Storage sites at both ends of the barrier will be needed for the barrier-moving machine.

#### **1010.09(1)(c) Portable Steel Barriers**

Portable steel barriers have a lightweight stackable design. They have options for gate-type openings and relocation without heavy equipment. Lateral displacement from impacts is in the range of 6 to 8 feet. Steel barriers can be anchored according to the manufacturer's specifications. Some deflection with anchored systems is still expected.

### **1010.09(2) Impact Attenuators**

Within the Design Clear Zone, the approach ends of temporary barriers shall be fitted with impact attenuators. The information in [Chapter 1620](#) provides all the needed impact attenuator performance information, but the actual work zone location may require careful consideration by the designer to ensure the correct application is used. Consider the dynamic nature of work operations where work zone ingress and egress, work area protection, worker protection, and traffic protection all factor into the final selection as well as the placement surface available.

Contract plans showing temporary impact attenuator placement need to include a list of the approved attenuators that a contractor may use for that installation.

### **1010.09(3) *Transportable Attenuators***

A transportable attenuator (TA) is a positive protection device that will provide protection for the work area only a short distance in front of the device. An impact attenuator device is attached to the rear of a large truck the weighs 15,000 lbs. total weight or more to minimize the roll-ahead distance when impacted by an errant vehicle. A TA should be used on all high-speed roadway operations.

## **1010.10 Other Traffic Control Devices or Features**

### **1010.10(1) *Delineation***

Temporary pavement markings will be required when permanent markings are eliminated because of construction operations or when lane shifts or temporary alignments are needed for long-term work zone strategies. Temporary pavement markings can be made using paint, tape, or raised pavement markers. Short-duration temporary pavement markings are made with materials intended to last only until permanent markings can be installed on paving and BST projects, or for short durations between construction stages. Broken line patterns consist of a 4 foot line with a 36-foot gap. Temporary edge lines are usually not required on paving/BST projects and must be specified in the plans if desired. Long-duration temporary pavement markings are made with materials intended to last for staged construction on high-volume highways, for use between construction seasons, or for long-duration lane shifts. Existing contradictory pavement markings must be removed. These markings are installed in accordance with the Standard Plans for permanent markings. Long-duration markings need to be detailed in the contract plans for installation and material type. Removable tapes work well for broken lines and can be removed by hand, leaving no scar on the pavement surface. Complex projects will most likely require both long- and short-duration temporary markings.

Lateral clearance markers are used at the angle points of barriers where they encroach on or otherwise restrict the adjacent shoulder. Barrier delineation is necessary where the barrier is less than 4 feet from the edge of traveled way.

Guideposts may be considered to aid nighttime driving through temporary alignments or diversions. (See [Chapter 1030](#) for delineation requirements.)

### **1010.10(2) *Screening***

Screening devices can be used to reduce motorists' distraction due to construction activities adjacent to the traveled way. Consider screening when a highway operates near capacity during most of the day. Screening should be positioned behind traffic barriers to prevent impacts by errant vehicles and should be anchored or braced to resist overturning when buffeted by wind. Commercially available screening or contractor-built screening can be used, provided the device meets crashworthy criteria if exposed to traffic and is approved by the Engineer prior to installation.

Glare screening may be required on concrete barriers separating two-way traffic to reduce headlight glare from oncoming traffic. Woven wire and vertical blade-type screens are commonly used in this installation. This screening also reduces the potential for motorist

confusion at nighttime by shielding construction equipment and the headlights of other vehicles on adjacent roadways. Make sure that motorists' sight distance is not impaired by these glare screens. Contact the HQ Design Office and refer to AASHTO's Roadside Design Guide for additional information on screening.

### **1010.10(3) Illumination**

Illumination might be justified if construction activities take place on the roadway at night for an extended period of time. Illumination might also be justified for long-term construction projects at the following locations:

- Road closures with detours or diversions.
- Median crossovers on freeways.
- Complex or temporary alignment or channelization.
- Haul road crossings (if operational at night).
- Temporary traffic signals.
- Temporary ramp connections.
- Projects with lane shifts and restricted geometrics.
- Projects with existing illumination that needs to be removed as part of the construction process.

Illumination is required when:

- Traffic flow is split around or near an obstruction.
- Flaggers are necessary for nighttime construction activities (supplemental lighting of the flagger stations by use of portable light plants or other approved methods). Refer to *Standard Specification* 1-10.3(1)A.

For information on light levels and other electrical design requirements, see [Chapter 1040](#).

### **1010.10(4) Signals**

A permanent signal system can be modified for a temporary configuration such as temporary pole locations during intersection construction, span wire systems, and adjustment of signal heads and alternative detection systems to accommodate a construction stage (see [Chapter 1330](#)).

### **1010.10(5) Work Zone Intelligent Transportation Systems (ITS)**

Intelligent Transportation Systems apply advanced technologies to optimize the safety and efficiency of the existing transportation network. Many permanent systems already exist throughout Washington State and provide the opportunity to greatly enhance construction projects that fall within the limits of the ITS network. Temporary portable ITS applications in work zones can be used to provide traffic monitoring and management, data collection, and traveler information.

ITS can provide real-time work zone information and associated traffic conditions such as queue detection for "slowed or stopped traffic ahead" before motorists see brake lights, or they can

advise of alternate routes, giving motorists options to avoid delays and warn drivers of haul vehicles entering or leaving a work area.

Work zone ITS technology is an emerging area that can provide the means to better monitor and manage traffic flow through and around work zones. Equipment used in work zones, such as portable camera systems, highway advisory radios, variable speed limits, ramp metering systems, and queue detection sensors, helps ensure a more efficient traffic flow with a positive impact on safety, mobility, access, and productivity.

Identify work zone ITS elements early in the strategy development process and include them in the preliminary estimate so they can be designed along with the other traffic control elements. For large mobility projects that have existing freeway cameras already in place, temporary ITS features (such as temporary poles and portable systems) may be necessary to ensure the network can be maintained during construction, especially if existing camera locations are in conflict with construction activities. In locations that do not have existing camera locations, but have significant construction projects planned, work zone ITS may be a good opportunity to bring ITS technology to the route.

Refer to [Chapter 1050](#) and the work zone safety web page for additional ITS information and guidance.

## **1010.11 Traffic Control Plan Development and PS&E**

WSDOT projects need to include plans and payment items for controlling traffic based on a strategy that is consistent with the project construction elements, even though there may be more than one workable strategy. A constructable and biddable method of temporary traffic control is the goal. The contractor has the option of adopting the contract plans or proposing an alternative method.

### **1010.11(1) Traffic Control Plans (TCPs)**

“Typical” traffic control plans are generic in nature and are not intended to address all site conditions. They are intended for use at multiple work locations and roadways with little or no field modifications necessary. Typical plans may be all that are needed for basic paving projects. Some typical plans are located at: [www.wsdot.wa.gov/design/standards/plansheet.htm](http://www.wsdot.wa.gov/design/standards/plansheet.htm)

“Project-specific” traffic control plans are typical-type plans that have been modified to fit a specific project or roadway condition. Dimension lines for signs and device placement have the distances based on the project highway speed limit, and spacing charts have been removed; the lane and roadway configuration may also be modified to match the project conditions.

“Site-specific” traffic control plans are drawn for a specific location. Scaled base data drawn plans will be the most accurate as device placement and layout issues can be resolved by the designer. These types of plans should be used for temporary alignment and channelization for long-duration traffic control. Making a “project-specific” plan applicable for a site-specific location is another option, but the designer must ensure the device layout will match the site-specific location since it will not be a scaled plan.

The following plans, in addition to the TCP types above addressing the TTC strategies, may be included in the PS&E.

### **1010.11(1)(a) Construction Sign Plan**

Show Class A Construction Signs that will remain in place for the duration of the project located by either station or milepost. Verify the locations to avoid conflicts with existing signing or other roadway features. These locations may still be subject to movement in the field to fit specific conditions. For simple projects these sign are often shown on the vicinity map sheet.

### **1010.11(1)(b) Construction Sign Specification Sheet**

Provide a Class A Construction Sign Specifications sheet on complex or staged projects. Include location, post information, and notes for Standard Plans or other specific sign information and sign details.

### **1010.11(1)(c) Quantity Tabulation Sheets**

Quantity Tabulation sheets are a good idea for barrier and attenuator items and temporary pavement markings on projects with large quantities of these items or for staged construction projects.

### **1010.11(1)(d) Traffic Control Plan Index**

An Index sheet is a useful tool for projects that contain a large quantity of traffic control plans and multiple work operations at various locations throughout the project. The Index sheet provides the contractor a quick referencing tool indicating the applicable traffic control plan for the specific work operation.

### **1010.11(1)(e) Construction Sequence Plans**

Sequence plans are placed early in the plan set and are intended to show the proposed construction stages and the work required for each stage. They should refer to the corresponding TCPs for the traffic control details of each stage.

### **1010.11(1)(f) Temporary Signal Plan**

The temporary signal plan will follow conventions used to develop permanent signals (as described in [Chapter 1330](#)), but will be designed to accommodate temporary needs and work operations to ensure there will be no conflicts with construction operations. Ensure opposing left-turn clearances are maintained as described in [Chapter 1310](#) if channelization has been temporarily revised, or adjust signal timing to accommodate. Some existing systems can be maintained using temporary span wires for signal heads and video, microwave actuation, or timed control.

### **1010.11(1)(g) Temporary Illumination Plan**

Full lighting is normally provided through traffic control areas where power is available. The temporary illumination plan will follow conventions used to develop permanent illumination (as described in [Chapter 1040](#)), but will be designed to accommodate temporary needs and work operations to ensure there will be no conflicts with construction operations.

## **1010.11(2) Contract Specifications**

Work hour restrictions for lane closure operations are to be specifically identified for each project where traffic impacts are expected and liquidated damages need to be applied to the

contract. Refer to the Plans Preparation Manual for additional information on writing traffic control specifications.

### **1010.11(3) Cost Estimating**

Temporary traffic control devices and traffic control labor can be difficult to estimate. There is no way of knowing how many operations a contractor may implement at the same time. The best method is to follow the working day estimate schedule and the TCPs that will be used for each operation. Temporary signs and devices will be used on many plans, but the estimated quantity reflects the most used at any one time. To use the lump sum item to pay for all temporary traffic control, be certain how the contractor's work operations will progress and that the traffic control plans fully define the work zone expectations.

### **1010.12 Training and Resources**

Temporary traffic control-related training is an important component in an effective work zone safety and mobility program. Federal regulations require that those involved in the development, design, implementation, operation, inspection, and enforcement be trained at a level consistent with their responsibilities.

#### **1010.12(1) Training Courses**

The following work zone related courses are available through the Talent Development office and the State Work Zone Training Specialist can assist with the availability and scheduling of classes:

- **Work Zone Traffic Control Plan Design Course:** This course, taught by the HQ Traffic Office, focuses on work zone safety and mobility through transportation management plan and temporary traffic control PS&E development.
- **Traffic Control Supervisor (TCS) Course:** The same course taught by the Evergreen Safety Council, NW Laborers Union, and ATSSA, for contractors is also taught by the HQ Traffic Office for WSDOT employees. Field personnel who have TCS related responsibilities or designers wanting basic temporary traffic control design and implementation training should attend this course. This course may be taken without the intention of becoming a certified TCS.
- **Flagger Certification Course:** This course is for employees who may have flagging duties or want to become a certified Traffic Control Supervisor. The safety offices can assist with class scheduling.

Traffic analysis, traffic engineering, pedestrian facilities design and other courses may also be available and apply to work zone safety and mobility.

The American Traffic Safety Services Association (ATSSA) offers free or low-cost training through an FHWA [work zone safety grant](#).

#### **1010.12(2) Resources**

The responsibility of the designer to fully address all work zone traffic control impacts is very important because the level of traffic safety and mobility will be directly affected by the effectiveness of the transportation management plan (TMP). The following resources are available to assist the designer with various aspects of the work zone design effort.

### **1010.12(2)(a) Region Work Zone Resources**

Each region has individuals and offices with various resources that provide work zone guidance and direction beyond what may be available at the project Design Office level. They include:

- Region Traffic Office
- Region Work Zone Specialist
- Region Construction and Design Offices

### **1010.12(2)(b) Headquarters (HQ) Work Zone Resources**

The HQ Traffic Office has a work zone team available to answer questions, provide information, or otherwise assist. The HQ Design and Construction offices may also be able to assist with some work zone issues. They include:

- State Assistant Traffic Design Engineer
- State Work Zone Engineer
- State Work Zone Training Specialist
- WSDOT Work Zone Web Page

### **1010.12(2)(c) FHWA Work Zone Resources**

The FHWA Washington Division Office and Headquarters (HQ) Office may be able to provide some additional information through the WSDOT HQ Traffic Office. The FHWA also has a work zone web page: [www.ops.fhwa.dot.gov/wz/](http://www.ops.fhwa.dot.gov/wz/)

## **1010.13 Documentation**

Refer to [Chapter 300](#) for design documentation requirements.

## **1010.14 References**

### **1010.14(1) Federal/State Laws and Codes**

[23 Code of Federal Regulations \(CFR\) Part 630 Subpart J and Subpart K – Work Zone Safety and Mobility and Temporary Traffic Control Devices](#)

See [Chapter 1510](#) for Americans with Disabilities Act policy and references.

“Final Rule on Work Zone Safety and Mobility,” Federal Highway Administration (FHWA),  
[Published on September 9, 2004](#)

[www.ops.fhwa.dot.gov/wz/resources/final\\_rule.htm](http://www.ops.fhwa.dot.gov/wz/resources/final_rule.htm)

[Manual on Uniform Traffic Control Devices for Streets and Highways](#), USDOT, FHWA; as adopted and modified by [Chapter 468-95 WAC](#) “Manual on uniform traffic control devices for streets and highways” (MUTCD)

### **1010.14(2) Design Guidance**

[A Policy on Geometric Design of Highways and Streets \(Green Book\)](#), AASHTO



Executive Order E 1001, Work Zone Safety and Mobility

🔗 <http://wwwi.wsdot.wa.gov/publications/policies/fulltext/1001.pdf>

Executive Order E 1060, Speed Limit Reductions in Work Zones

🔗 <http://wwwi.wsdot.wa.gov/publications/policies/fulltext/1060.pdf>

Executive Order E 1033, WSDOT Employee Safety

🔗 <http://wwwi.wsdot.wa.gov/publications/policies/fulltext/1033.pdf>

*Plans Preparation Manual*, M 22-31, WSDOT

*Standard Plans for Road, Bridge, and Municipal Construction* (Standard Plans), M 21-10, WSDOT

*Standard Specifications for Road, Bridge, and Municipal Construction* (Standard Specifications), M 41-10, WSDOT

*Traffic Manual*, M 51-02, WSDOT

*Work Zone Traffic Control Guidelines*, M 54-44, WSDOT

### **1010.14(3) Supporting Information**

*Construction Manual*, M 41-01, WSDOT

“Crashworthy Work Zone Traffic Control Devices,” Report 553, NCHRP, 2006

*Environmental Manual*, M 31-11, WSDOT

*Highway Capacity Manual*, 2010, TRB

*ITE Temporary Traffic Control Device Handbook*, 2001

*ITS in Work Zones* 🔗 [www.ops.fhwa.dot.gov/wz/its/](http://www.ops.fhwa.dot.gov/wz/its/)

“Recommended Procedures for the Safety Evaluation of Highway Features,” Report 350, NCHRP, 1993

*Roadside Design Guide*, AASHTO, 2011

*Manual for Assessing Safety Hardware*, AASHTO, 2009

Work Zone & Traffic Analysis, FHWA 🔗 [www.ops.fhwa.dot.gov/wz/traffic\\_analysis.htm](http://www.ops.fhwa.dot.gov/wz/traffic_analysis.htm)

*Work Zone Operations Best Practices Guidebook*, FHWA, 2007

🔗 [www.ops.fhwa.dot.gov/wz/practices/practices.htm](http://www.ops.fhwa.dot.gov/wz/practices/practices.htm)

Work Zone Safety and Mobility, FHWA 🔗 [www.ops.fhwa.dot.gov/wz/index.asp](http://www.ops.fhwa.dot.gov/wz/index.asp)

Work Zone Safety Web Page, WSDOT 🔗 [www.wsdot.wa.gov/safety/workzones/](http://www.wsdot.wa.gov/safety/workzones/)

WSDOT Project Management website: 🔗 <http://www.wsdot.wa.gov/Projects/ProjectMgmt/>

### Exhibit 1010-3 Transportation Management Plan Components Checklist

Use the following checklist to develop a formal TMP document on significant projects.

TMP Component	✓
<b>1. Introductory Material</b>	
Cover page	
Licensed Engineer stamp page (if necessary)	
Table of contents	
List of figures	
List of tables	
List of abbreviations and symbols	
Terminology	
<b>2. Executive Summary</b>	
<b>3. TMP Roles and Responsibilities</b>	
TMP manager	
Stakeholders/review committee	
Approval contact(s)	
TMP implementation task leaders (public information liaison, incident management coordinator)	
TMP monitors	
Emergency contacts	
<b>4. Project Description</b>	
Project background	
Project type	
Project area/corridor	
Project goals and constraints	
Proposed construction phasing/staging	
General schedule and timeline	
Adjacent projects	
<b>5. Existing and Future Conditions</b>	
Data collection and modeling approach	
Existing roadway characteristics (history, roadway classification, number of lanes, geometrics, urban/suburban/rural)	
Existing and historical traffic data (volumes, speed, capacity, volume-to-capacity ratio, percent trucks, queue length, peak traffic hours)	
Existing traffic operations (signal timing, traffic controls)	
Incident and crash data	
Local community and business concerns/issues	
Traffic growth rates (for future construction dates)	
Traffic predictions during construction (volume, delay, queue)	
<b>6. Work Zone Impacts Assessment Report</b>	
Qualitative summary of anticipated work zone impacts	
Impacts assessment of alternative project design and management strategies (in conjunction with each other)	
<ul style="list-style-type: none"> <li>• Construction approach/phasing/staging strategies</li> <li>• Work zone impacts management strategies</li> </ul>	

**Exhibit 1010-3 Transportation Management Plan Components Checklist (continued)**

TMP Component	✓
Traffic analysis results (if applicable)	
• Traffic analysis strategies	
• Measures of effectiveness	
• Analysis tool selection methodology and justification	
• Analysis results	
Traffic (volume, capacity, delay, queue, noise)	
Safety	
Adequacy of detour routes	
Business/community impact	
Seasonal impacts	
Cost-effectiveness/evaluation of alternatives	
Selected alternative	
• Construction approach/phasing/staging strategy	
• Work zone impacts management strategies	
<b>7. Selected Work Zone Impacts Management Strategies</b>	
Temporary Traffic Control (TTC) strategies	
• Control strategies	
• Traffic control devices	
• Corridor Project coordination, contracting, and innovative construction strategies	
Public Information (PI)	
• Public awareness strategies	
• Motorist information strategies	
Transportation Operations (TO)	
• Demand management strategies	
• Corridor/network management strategies	
• Work zone safety management strategies	
• Traffic/incident management and enforcement strategies	
<b>8. TMP Monitoring</b>	
Monitoring requirements	
Evaluation report of successes and failures of TMP	
<b>9. Contingency Plans</b>	
Trigger points	
Decision tree	
Contractor's contingency plan	
Standby equipment or personnel	
<b>10. TMP Implementation Costs</b>	
Itemized costs	
Cost responsibilities/sharing opportunities	
Funding source(s)	
<b>11. Special Considerations (as needed)</b>	
<b>12. Attachments (as needed)</b>	

- 1050.01 General
- 1050.02 References
- 1050.03 Systems Engineering
- 1050.04 FHWA Washington Division ITS Project Contracting Guidance
- 1050.05 Documentation

### 1050.01 General

Intelligent Transportation Systems (ITS) have the potential to reduce crashes and increase mobility of transportation facilities. They also enhance productivity through the use of advanced communications technologies and their integration into vehicles and the transportation infrastructure. These systems involve a broad range of wireless and wire line communications-based information, electronics, or information processing technologies. Some of these technologies include cameras, variable message signs, ramp meters, road weather information systems, highway advisory radios, traffic management centers, and adaptive signal control technology (ASCT). ASCT is a traffic signal system that detects traffic conditions and adjusts signal timing remotely in response. More information on ASCT can be found at:

[www.fhwa.dot.gov/everydaycounts/technology/adsc](http://www.fhwa.dot.gov/everydaycounts/technology/adsc)

The purpose and direction of ITS for the Washington State Department of Transportation (WSDOT) can be found in the Statewide Intelligent Transportation Systems Plan, which is available upon request from the Headquarters (HQ) Traffic Operations Office. The plan identifies the current and long-term ITS needs to meet the objectives identified in Moving Washington, WSDOT's program to fight traffic congestion.

The Statewide ITS Plan is a comprehensive document that discusses:

- The history of ITS deployment in Washington.
- How ITS meets WSDOT's transportation vision and goals.
- The current state of ITS deployment.
- WSDOT's near-term ITS plans.
- How projects are prioritized.
- What long-term ITS issues WSDOT needs to begin planning for.

Due to the dynamic nature of ITS, printed guidance is soon outdated. Detailed design guidance and current practices are located on the following websites. For additional information and direction, contact the region Traffic Engineer or the HQ Traffic Operations Office:

[www.wsdot.wa.gov/design/traffic/](http://www.wsdot.wa.gov/design/traffic/)

## 1050.02 References

23 Code of Federal Regulations (CFR), Part 940, Intelligent Transportation System Architecture and Standards

🔗 <http://www.ecfr.gov>

USDOT, *Systems Engineering for Intelligent Transportation Systems*, FHWA-HOP-07 069, January 2007

🔗 <http://ops.fhwa.dot.gov/publications/seitsguide/index.htm>

USDOT/CalTrans, *Systems Engineering Guidebook for Intelligent Transportation Systems*, Version 3, November 2009

🔗 <http://www.fhwa.dot.gov/cadiv/segb/>

USDOT, *Model Systems Engineering Documents for Adaptive Signal Control Technology (ASCT) Systems*, FHWA HOP-11-027, August 2012

🔗 <http://www.ops.fhwa.dot.gov/publications/fhwahop11027/index.htm>

*Manual on Uniform Traffic Control Devices for Streets and Highways*, USDOT, FHWA; as adopted and modified by Chapter 468-95 WAC “Manual on uniform traffic control devices for streets and highways” (MUTCD)

🔗 [www.wsdot.wa.gov/publications/manuals/mutcd.htm](http://www.wsdot.wa.gov/publications/manuals/mutcd.htm)

SAFETEA-LU (Safe Accountable Flexible Efficient Transportation Equity Act: A Legacy for Users)

🔗 <http://www.fhwa.dot.gov/safetealu/index.htm>

MAP-21 (Moving Ahead for Progress in the 21st Century Act)

🔗 <http://www.fhwa.dot.gov/map21/>

WSDOT Northwest Region Traffic Design

🔗 <http://www.wsdot.wa.gov/northwest/trafficdesign>

WSDOT Traffic Design

🔗 <http://www.wsdot.wa.gov/design/traffic/>

## 1050.03 Systems Engineering

Systems engineering is a typical part of any ITS project development process. It is required on any federal-aid project that has an ITS work element, per 23 CFR 940.11. Systems engineering is an interdisciplinary step-by-step process for complex projects (such as ITS projects) to:

- Assess a system’s needs and its relationship to the regional architecture.
- Plan a project that meets those needs as well as stakeholder needs and expectations.
- Define other specific requirements for the project/system.
- Develop and implement the project/system.
- Define the operations and maintenance requirements for the system.
- Plan for the refinement or replacement of the system.

Using systems engineering on ITS projects has been shown to increase the likelihood of a project’s success. A successful project is one that meets the project scope and stakeholder/project sponsor expectations, is completed on time and within budget, and is efficient and cost-effective to operate and maintain.

The level of systems engineering used for a project should be on a scale commensurate with the scope, cost, and risk of the project. Complete the Intelligent Transportation Systems (ITS) Systems Engineering Analysis Worksheet in [Exhibit 1050-2](#), or a document with the same information, for all federal-aid projects that include ITS elements. Completing the Worksheet will meet the minimum requirements in [23 CFR 940.11](#) for systems engineering, determine the project's risk, and determine if a more in-depth systems engineering analysis is required. The Worksheet and the four systems engineering documents outlined below are to be completed with coordination between the project engineer and region Traffic Engineer.

As shown in the Worksheet, a more in-depth analysis requires that the following four documents be completed and used to implement the project. These documents are produced as the result of the steps in the systems engineering process.

1. **Concept of Operations:** This document defines the problem, the project's goals, stakeholder needs and expectations, constraints, and the way the ITS system is required to operate and be maintained.
2. **System Requirements:** This document contains specifications of what the system is required to do, how well it is required to do it, and under what conditions. These requirements are based on the goals, stakeholder needs and expectations, constraints, and operation and maintenance requirements documented in the Concept of Operations.
3. **System Verification Plan:** This document describes how the agency will verify that the system being built meets the requirements in the System Requirements document. The agency will implement the System Verification Plan to ensure all system requirements are verified before it accepts the system.
4. **System Validation Plan:** This document describes how the agency will assess the system's performance against the goals, stakeholder needs and expectations, constraints, and operation and maintenance requirements documented in the Concept of Operations. The goal is for the agency to understand and review the strengths and weaknesses of the system and identify any new opportunities and needs if appropriate. The agency will implement the System Validation Plan after it accepts the system. This evaluation sets the stage for the next time the system/project is changed or expanded.

For specific guidance on developing the four systems engineering plans listed above, see the plan templates in the USDOT/CalTrans document, [Systems Engineering Guidebook for Intelligent Transportation Systems](#), Version 3, November 2009. Pertinent page numbers include:

- Concept of Operations Template: Page 254
- System Requirements Template: Page 257
- Verification Documents Plan Template: Page 269
- Validation Documents Plan Template: Page 278

For Adaptive Signal Control Technology Projects (ASCT) using the latest edition of the USDOT [Model Systems Engineering Documents for Adaptive Signal Control Technology \(ASCT\) Systems](#), FHWA-HOP-11-027, August 2012, is required.

As each phase of an ITS project is completed, a report is to be submitted by the Project Engineer to the region Traffic Engineer describing how the project is meeting the requirements outlined in the above systems engineering plans. Approvals for ITS projects are dependent upon project complexity and cost. (See [Chapter 300](#) for ITS project approval requirements.)

Systems engineering costs are to be estimated and incorporated into the construction engineering (CE) and project engineering (PE) portions of the construction estimate.

For further project development guidance related to procurement and administration of Federal-Aid Intelligent Transportation System (ITS) contracts, see [1050.04](#).

### 1050.03(1) Systems Engineering Process “V” Diagram

The systems engineering process contains a number of steps that are not included in a traditional project delivery process. The systems engineering process is often referred to as the “V” diagram (see [Exhibit 1050-1](#)). An ITS project begins on the left side of the “V” and progresses down the left side and then up the right side. Then the project is evaluated by validating and verifying the elements on the right side of the “V” with the elements on the left side.

The Federal Highway Administration (FHWA) and WSDOT are in agreement that, for project development and delivery, the most critical portions of the systems engineering process are the Concept of Operations; System Requirements; System Verification; and System Validation. As a result, the Intelligent Transportation Systems (ITS) Systems Engineering Analysis Worksheet in [Exhibit 1050-2](#) is focused on these core areas.

**Exhibit 1050-1 Systems Engineering Process “V” Diagram**

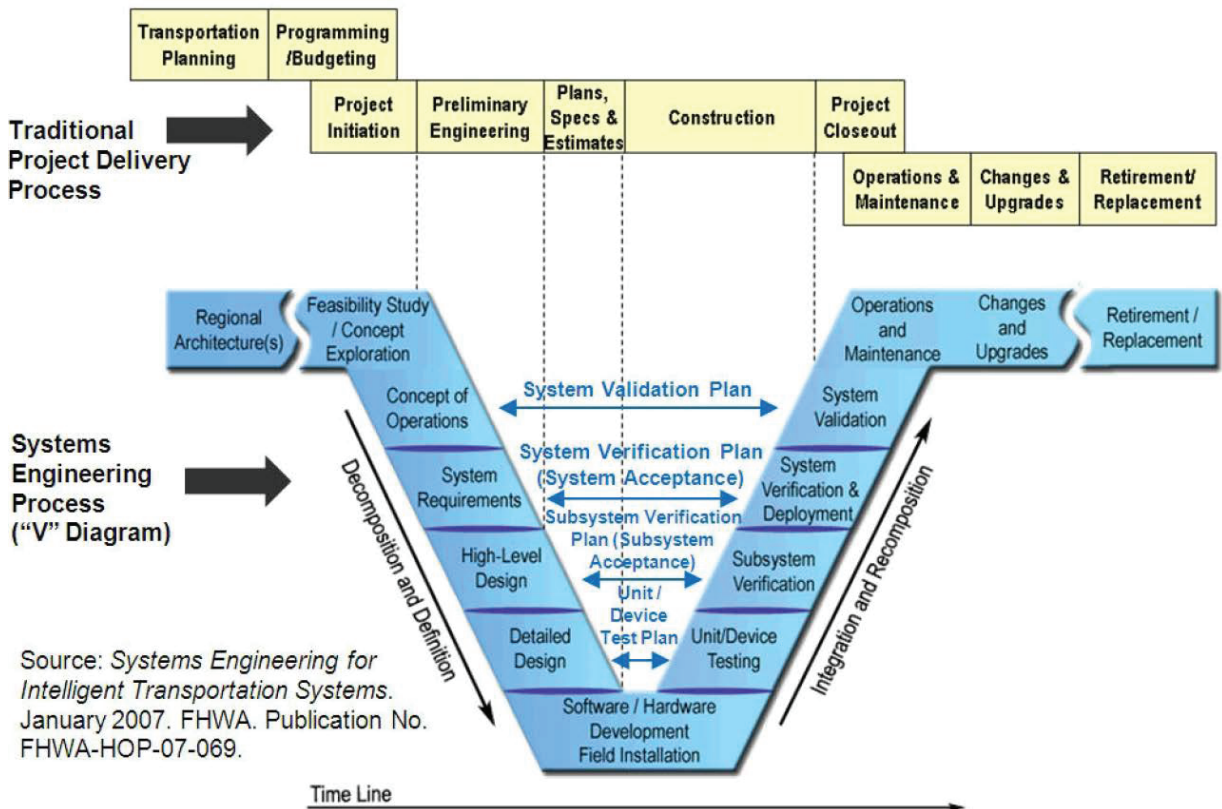



## **1050.04 FHWA Washington Division ITS Project Contracting Guidance**

### **1050.04(1) Purpose**

The purpose of this document is to provide basic guidance related to the procurement and administration of Federal-Aid ITS contracts.

### **1050.04(2) Scope**

This document is intended to be used by the FHWA Washington Division Office, WSDOT, and local agencies as a guide on the proper types of procurement methods for various types of ITS projects. This guidance is not all-encompassing, as ITS projects can vary significantly in scope. However, it should provide adequate information to address a majority of situations. Specific questions about an individual ITS project should be directed to the Washington Division Office.

### **1050.04(3) Construction versus Non-Construction**

ITS improvements may be incorporated as part of a traditional federal-aid construction contract, or the contracting agency may elect to procure ITS services under a separate contract (i.e., stand-alone ITS projects). When procured as a separate contract, the scope of an ITS contract will determine the applicability of federal procurement requirements. [Title 23 United States Code 101\(a\)\(4\)](#) provides a broad definition for construction for federal-aid eligibility purposes. FHWA generally interprets the definition broadly, resulting in many types of projects being classified as construction. Very simply, a contract that incurs costs incidental to the construction or reconstruction of a highway, including improvements that directly facilitate and control traffic flow (e.g., traffic control systems) are by definition construction contracts. This includes rehabilitation of an existing physical ITS infrastructure. Construction contracts must follow the regulatory requirements of [23 CFR 635](#) or [23 CFR 636](#) in the case of Design-Build.

Non-construction-type ITS contracts will be either Engineering Contracts or Service Contracts. Engineering is defined as professional services of an engineering nature as defined by state law. If the ITS contract primarily involves engineering, then qualifications-based selection (QBS) procedures, in compliance with the Brooks Act, must be followed. Service contracts (non-construction, non-engineering in nature) are to be procured in accordance with the Common Rule for Grants and Cooperative Agreements to States and Local Governments found at [49 CFR 18.36](#).

### **1050.04(4) Types of ITS Projects**

Stand-alone ITS projects can generally be categorized into one of the following types of ITS projects: (1) planning/research, (2) preliminary engineering/project development, (3) software development/system integration, (4) system deployments, (5) traditional construction, and (6) operations and maintenance. All Federal-Aid ITS projects, regardless of the type, are directed in [23 CFR 940](#) to follow a systems engineering process.

[Exhibit 1050-3](#) provides further information about each of these ITS project types.

## **1050.05 Documentation**

Include all ITS systems engineering documentation in the Design Documentation Package (DDP). All systems engineering documentation requires region Traffic Engineer approval.

### Intelligent Transportation Systems Systems Engineering Analysis Worksheet

This worksheet, or a document with the same information, must be completed for all federal-aid projects that include Intelligent Transportation Systems (ITS) elements. This worksheet must be completed prior to submitting a construction authorization request and must be kept in the project file for the entire document retention period of the project. If Concept of Operations, System Requirements, Verification Plan, and Validation Plan documents are required for the project, as determined by this spreadsheet, these documents must be submitted for review prior to submitting a construction authorization request and must be kept in the project file for the entire document retention period.

1. **Project Name:** Click here to enter text.
  
2. **Contract Number:** Click here to enter text.
  
3. **Total project cost (includes preliminary engineering/design, right of way, and construction phases):** Click here to enter text.
  
4. **Amount of total project cost for ITS elements:** Click here to enter text.
  
5. Will this project implement a new or expand an existing adaptive signal control technology (ASCT) system?
  - Yes      FHWA and WSDOT consider the project to be high risk. Four additional systems engineering documents (Concept of Operations, System Requirements, Verification Plan, and Validation Plan) are required. (See definitions in [1050.03 Systems Engineering](#).) These documents must be produced using the latest edition of the USDOT *Model Systems Engineering Documents for Adaptive Signal Control Technology (ASCT) Systems*, FHWA-HOP-11-027, August 2012. *Please skip questions 6 and 7.*
  
  - No

6. Select which of the following items, if any, apply to this project:

- The project includes new and unproven hardware and/or communications technology that is considered “cutting edge” or not in common use. This could include custom-developed or unproven commercial-off-the-shelf (COTS) technology that has not been used by the agency previously. *Please explain why you selected or did not select this item.*

[Click here to enter text.](#)

- The project will add new software that will be custom developed for this project or will make major modifications to existing custom-developed software. *Please explain why you selected or did not select this item.*

[Click here to enter text.](#)

- The project will add new interfaces to systems operated or maintained by other agencies. *Please explain why you selected or did not select this item.*

[Click here to enter text.](#)

- The project will develop new system requirements or require revisions to existing system requirements that are not well understood within the agency and/or well documented at this time. These system requirements will be included in a request for proposal, or plans, specifications, and estimate bid document package. Therefore, it will require significant stakeholder involvement and/or technical expertise to develop these items during the project delivery process. *Please explain why you selected or did not select this item.*

[Click here to enter text.](#)

- Multiple agencies will be responsible for one or more aspects of the project design, construction, deployment, and/or the ongoing operations and maintenance of the system. *Please explain why you selected or did not select this item.*

[Click here to enter text.](#)

7. If you answered yes to any of the items in question 6, FHWA and WSDOT consider the project to be high risk. See the following table for additional requirements.

Project Risk Level	Total Project Cost for ITS Elements	
	Less than \$1,000,000 <sup>[3]</sup>	Equal or Greater than \$1,000,000 <sup>[3]</sup>
<b>High-Risk ITS</b>	Additional systems engineering documents (Concept of Operations, System Requirements, Verification Plan, and Validation Plan) <sup>[2]</sup> are recommended. <sup>[1]</sup>	Additional systems engineering documents (Concept of Operations, System Requirements, Verification Plan, and Validation Plan) <sup>[2]</sup> are required.
<p><b>Notes:</b></p> <p>[1] A decision not to complete the additional systems engineering documents for high-risk projects that have less than \$1,000,000 of ITS elements requires FHWA concurrence prior to submitting a construction authorization request.</p> <p>[2] See definitions in 1050.03, Systems Engineering.</p> <p>[3] Use the amount from question 4.</p>		

8. What is the name of the regional ITS architecture and which portions of the architecture will be implemented? Is the project consistent with the architecture? Are revisions to the architecture required? Also, which user services, physical subsystem elements, information flows, and market/service packages will be completed, and how will these pieces be part of the architecture?

Click here to enter text.

9. Identify the participating agencies, their roles and responsibilities, and the concept of operations. For the elements and market/service packages to be implemented, define the high-level operations of the system. This includes where the system will be used, its performance parameters, its life cycle, and who will operate and maintain it. Discuss the established requirements or agreements on information sharing and traffic device control responsibilities. The regional ITS architecture operational concept is a good starting point for discussion.

If this is a high-risk project and a more extensive Concept of Operations document is being prepared for this project (see question 7), this answer can be a simple reference to that document.

Click here to enter text.

10. Define the system requirements. Based on the concept of operations, define the “what” and not the “how” of the system. Define the detailed requirements for eventual detailed design. The applicable high-level functional requirements from the regional architecture are a good starting point for discussion. A review of the requirements by the project stakeholders is recommended.

If this is a high-risk project, and a more extensive System Requirements document is being prepared for this project (see question 7), this answer can be a simple reference to that document.

[Click here to enter text.](#)

11. Provide an analysis of alternative system configurations and technology options to meet requirements. This analysis should outline the strengths and weaknesses, technical feasibility, institutional compatibility, and life cycle costs of each alternative. The project stakeholders should have had input in choosing the preferred solution.

[Click here to enter text.](#)

12. Identify procurement/contracting options. Since there are different procurement methods for different types of projects, the decision regarding the best procurement option should consider the level of agency participation, compatibility with existing procurement methods, the role of the system integrator, and life cycle costs. Some options to consider include: consultant design/low-bid contractor, systems manager, systems integrator, task order, and design/build.

If the ITS portions of the project significantly meet the definition of construction, then construction by low-bid contract would be used. Non-construction ITS portions of the project, such as services for software development, systems integration, systems deployment, systems management, or design, will be either engineering or service contracts. In these cases, a qualifications-based selection (QBS) or best value procurement may be more appropriate. For guidance on procurement options for ASCT systems, refer to Pages 15-20 of USDOT’s *Model Systems Engineering Documents for Adaptive Signal Control Technology (ASCT) Systems*, FHWA-HOP-11-027, August 2012.

[Click here to enter text.](#)

13. Identify the applicable ITS standards and testing procedures. Include documentation on which standards will be incorporated into the system design. Also, include justification for any applicable standards not incorporated. The standards discussion in the regional architecture is a good starting point for discussion.

[Click here to enter text.](#)

14. Outline the procedures and resources necessary for operations and management of the system. In addition to the concept of operations, document any internal policies or procedures necessary to recognize and incorporate the new system into the current operations and decision-making processes. Also, resources necessary to support continued operations, including staffing and training, must be recognized early and be provided for. Such resources must also be provided to support necessary maintenance and upkeep to ensure continued system viability.

[Click here to enter text.](#)

Exhibit 1050-3 FHWA Washington Division – ITS Project Contracting Guidance

ITS Project Type	Description	Examples
Planning/Research	Generally, involves studies that research new concepts or develop plans or procedures at a broader agency- or region-wide level. These are generally not construction and are often done by agency personnel.	<ul style="list-style-type: none"> <li>• Regional ITS architecture development and maintenance</li> <li>• Regional Concept of Operation</li> <li>• Traffic incident management planning</li> <li>• Standards testing and specification development</li> <li>• Public outreach and communication</li> </ul>
Preliminary Engineering/Project Development	Generally, a project, or phase of a larger project, that leads to some type of ITS deployment/construction. Typically involve some type of service or engineering contact, or work done by agency personnel, and are generally not considered construction.	<ul style="list-style-type: none"> <li>• Scoping/field surveys</li> <li>• Project-level Concept of Operation</li> <li>• Environmental Review</li> <li>• Development of RFPs</li> <li>• Development of PS&amp;Es</li> <li>• Evaluation of technology, networking, systems architecture alternatives</li> </ul>
Software Development/System Integration	Generally, involves projects that develop new or upgraded ITS-related software or involve integrating ITS services and equipment. These are typically not construction and often fall under a service contract.	<ul style="list-style-type: none"> <li>• Traffic Management Center (TMC) central software design, development, installation</li> <li>• Modifying existing central system software to communicate with new field equipment</li> <li>• Incorporation of device control software into central systems</li> <li>• Acceptance testing and configuration management</li> </ul>
System Deployments	Generally, includes total system implementation involving design, equipment, computer systems, telecommunications, and integration. Contracts are often non-construction in nature, depending on the amount and type of field work relative to the overall project. These types of projects will often be the least cut-and-dried in terms of the appropriate contracting method.	<ul style="list-style-type: none"> <li>• Road-weather information systems (RWIS)</li> <li>• Surveillance camera procurement and installation on existing poles (non-construction when limited in scope)</li> <li>• Non-intrusive sensor procurement and installation on existing poles (non-construction when limited in scope)</li> <li>• Adaptive Signal Control Systems</li> </ul>
Traditional Construction	Typical construction projects involving considerable installation of equipment or work in the field. Design-Bid-Build (low bid) or Design-Build contracting are appropriate for this type of work.	<ul style="list-style-type: none"> <li>• Installation of variable message signs</li> <li>• Installation of poles, controller cabinets, foundations, guardrail, gantries</li> <li>• Installation of radio towers and civil infrastructure for wireless systems</li> <li>• Installation of tolling field equipment (tag readers, video cameras, etc.)</li> <li>• Installation of underground infrastructure (trenching, cable installation, etc.)</li> </ul>
Operations/Maintenance	Ongoing operations and/or maintenance of ITS services, software, and equipment. Typically is a service contract (non-construction).	<ul style="list-style-type: none"> <li>• Operating costs for traffic monitoring, management, control systems (e.g., rent, communications, labor, utilities)</li> <li>• Preventative maintenance</li> </ul>



**Wisconsin Department of Transportation**

ITS Design and Operations Guide Chapter 40 Smart Work Zones Section 1 Technology, Standards, and Functional Requirements – October 2009

<https://wisconsin.gov/dtsdManuals/traffic-ops/manuals-and-standards/its/40/40-01.pdf>



## 40.1.1 Introduction

The guidance in Chapter 40 is intended for the placement of smart work zone equipment as part of construction projects. The use of smart work zone devices should be discussed with BHO Traffic Engineers prior to planning and deployment. Smart work zones are designed to mitigate construction related impacts, such as delay, increased travel times, and congestion-related crashes.

## 40.1.2 Needs Assessment

As part of the Transportation Management Plan (TMP) process, smart work zones are one alternative identified as a traffic mitigation strategy.

### 40.1.2.2 Criteria

Initial screening criteria to determine if a smart work zone is needed are provided below.

1. The Backbone user delay spreadsheets in the Lane Closure System (LCS) show delay, queues, and user costs for one and two lane closures along statewide freeways. If a particular work zone shows recurring delays of more than 15 minutes and/or sustained traffic volumes that exceed typical work zone capacity of 1,500 vehicles per hour per lane, then a smart work zone may be considered. Consider smart work zone cost in comparison to the anticipated user delay cost for the construction project.
2. It may be beneficial to install the permanent ITS equipment prior to the project so that it may be used as part of a smart work zone. Refer to the TOIP for proposed locations of permanent ITS as part of upcoming construction projects.

### 40.1.2.3 Types and Design Considerations

If one or more of the criteria are met, the designer can determine the type of smart work zone to implement. All smart work zone alternatives and placement should be discussed with BHO Traffic Engineering Section and the STOC.

- **Travel Time and/or Delay System**

This portable, automated, real-time smart work zone system informs drivers what the estimated travel time and/or delay is between drivers' current location and a specific destination beyond them. The system collects real-time traffic flow data using roadside non-intrusive sensors, calculates travel time and delay between different points, and displays the travel time and delay information on portable changeable message signs at pre-determined locations. This information will allow drivers to decide whether to change routes, provides them opportunity to notify others of their estimated arrival time, and generally provides drivers sufficient information to calm tempers. Consideration should be given to posting an alternate route. The system should be carefully monitored for accuracy and adjusted accordingly so accurate information is being given to drivers. PCMS can also be used to notify the driver of the current speed range within the work zone, known as itellizone.



- **Dynamic Late Merge**

When properly designed and deployed for a specific project, a DLM System should alert drivers of an upcoming traffic slow-down and inform them to use both lanes until the merge point. By encouraging use of all available lanes until the merge point, the system will reduce the length of a queue by around 40%. Reduced queue length allows better access to upstream interchanges. The DLM system also promotes more orderly merging, which may improve capacity at the merge point, reduce road rage incidents, and reduce the speed differential between lanes.



- **“Your Speed ” Signs**



Also known as radar speed display signs. This is a work zone strategy that attempts to influence drivers to reduce their speed. The speed limit is displayed along with the detected speed of an approaching vehicle. Some studies have shown it to reduce average and 85<sup>th</sup>-percentile speeds by 3 – 7 miles per hour, but the sign may lose effectiveness over time if left in place at the same location for a prolonged period.

- **Variable Speed (pre-determined speed limit changes)**

Can be used to easily lower the speed limit during construction hours and increase the speed limit when construction is not taking place, such as on weekends. This helps to eliminate the need to cover and uncover static signs and also helps to eliminate driver confusion if two different speed limit signs are accidentally left visible for drivers. Use of such device shall be discussed with the Regional Traffic Engineer.



- **Variable Speed (automatically changed speed limit)**

This system advises drivers of an appropriate vehicle speed to allow them to travel through the work zone with minimal braking. The system determines the average speed of downstream traffic and advises upstream traffic of an optimum speed to approach the queue. It is anticipated that the system will smooth the transition between faster and slower moving traffic, and provide an increase in capacity of the roadway through the work zone area. Automatic variable regulatory speed limits have not been used in Wisconsin due to potential conflict with State Statutes, but a speed advisory system using similar technology has been used with good results. Use of such device shall be discussed with the Regional Traffic Engineer.

- **PCMS**

Portable Changeable Message Signs are useful for displaying traveler information to the traveling public about work zone conditions. See Chapter 35 for more information.



- **Surveillance**

Portable surveillance can be used to view traffic conditions in a work zone. These images may be helpful in changing messages on PCMS according to traffic conditions



- **Detection**

Volume and speed data can be collected in a work zone using Wavetronix units. This data is useful in collecting work zone capacity data and speeds, which could help determine if other smart work zone strategies are needed. For more information on system detector stations, see Chapter 10 of this manual.



- **Moveable Barrier**

If there is a directional split of peak traffic demand (60% or more of the traffic in one direction), moveable barrier may be a good option. Moveable barrier provides the ability to change the number of lanes (capacity) according to directional traffic demand during construction.



Table 40.1 Smart Work Zone Design Process Checklist

1. <b>Complete TMP</b> to determine if smart work zones are recommended as a mitigation strategy (see 40.1.2)
2. Review <b>criteria</b> to determine if a smart work zone is needed (see 40.1.2.2)
3. Determine the <b>smart work zone type and placement</b> best suited for the location (see 40.1.2.3 and consult with BHO-TES and BHO-STOC).
4. Discuss the <b>power, communications, and any integration</b> needs with BHO-STOC (see 40.2).
5. Discuss <b>purchasing</b> options with BHO-TES and BHO-STOC to determine if it's best to have the contractor provide the equipment, utilize existing state owned equipment, or purchase the equipment through BHO-STOC (see 40.3).
6. Determine the <b>construction details, special provisions, and standard specification bid items</b> needed for the proposed design, along with those that <b>need to be modified</b> and <b>created</b> to provide a complete construction plan (Appendix 70).